

Easy to use with high-accuracy Resistance Meters for Production Lines and MRO

The Resistance Meters RM3544/RM3544-01/RM3548 can measure the winding resistance of devices such as motors and transformers, the contact resistance of power contacts (relays and switches), and the DC resistance of fuses, resistors, and substrates such as conductive rubber and sheets. It does so quickly and at a high level of accuracy using four-terminal measurement.

The RM3544/RM3544-01 is well suited to use for adjustment and testing on production lines as well as acceptance inspections, while the RM3548 comprises a portable solution for measuring resistance values ranging in magnitude from microohms to megohms, making it ideal for use in production, maintenance, repair and operation of large equipment.

Perform resistance measurement with an ideal combination of equipment depending on your component or equipment and test conditions.

Applications

■ Motors, solenoids, choke coils, transformers, wire harnesses

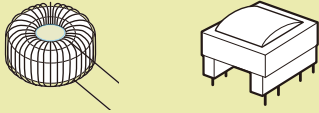

■ Contacts, wire harnesses, relay contacts, switches

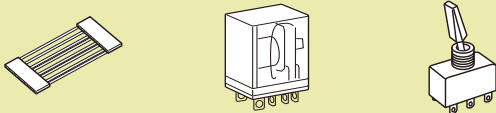

■ Conductive rubber, paint



■ Fuses, resistors, heaters, wires, welds



■ Large motors, large transformers

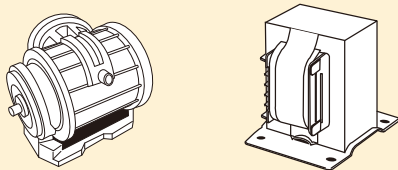

■ Temperature rise tests (Motors, choke coils, transformers)



■ Vehicle grounding lines, conductivity of aircraft fuselages

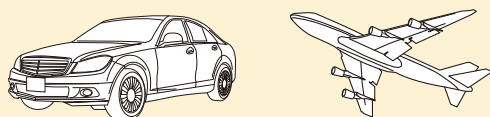

Probes suited to manual measurement on production lines



CLIP TYPE LEAD
L2101



4 -TERMINAL LEAD
L2104



PIN TYPE LEAD
L2102



PIN TYPE LEAD
L2103

Probes suited to DC measurement of the chassis and bodies of large equipment



CLIP TYPE LEAD
L2107



PIN TYPE LEAD
9465-10

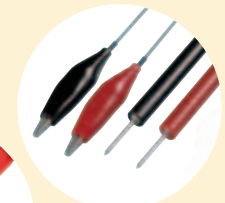

4 -TERMINAL LEAD
9453



LARGE CLIP TYPE LEAD
9467



PIN TYPE LEAD
9772

A Full Line-up of HIOKI Resistance Meters to Suit Your Measurement Range

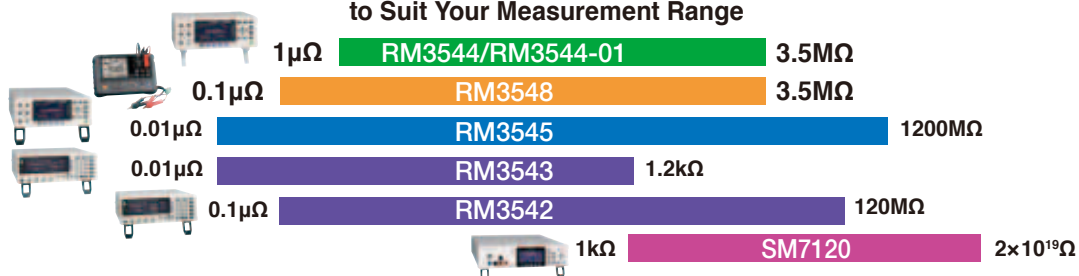

Robust specifications in a compact package

High-accuracy bench-top resistance meter
for both manual operation and integration with automatic lines



RESISTANCE METER RM3544/RM3544-01

Basic accuracy : **0.02%**

Max.resolution : **1 $\mu\Omega$**

Max.measurable current : **300mA**

- Measure from 0.000 m Ω (@ 300 mA) to 3.5 M Ω
- Probe for guard jack use and increased measurement current yield an instrument that's more resistant to noise.
- Optional LED COMPARATOR ATTACHMENT and high-volume judgment tones combine to ensure PASS/FAIL judgments are communicated reliably in the noisy environment of the production floor.
- EXT I/O interface with NPN/PNP support can accommodate a variety of automated production lines (-01 model).

High-accuracy portable resistance meter
measures from $\mu\Omega$ to M Ω



RESISTANCE METER RM3548

Basic accuracy : **0.02%**

Max.resolution : **0.1 $\mu\Omega$**

Max.measurable current : **1A**

- Measure from 0.0 $\mu\Omega$ (@ 1 A) to 3.5 M Ω
- Easily record up to 1,000 data points in memory simply by applying the instrument's probes. Smoothly capture temperature-rise test data using interval measurement.
- Portable design is ideal for maintenance and testing of large equipment.

Temperature correction

Generally, the resistance of copper wiring changes with temperature by 0.4% per degree Celsius. The RM3544/RM3544-01/RM3548 provides a temperature correction function to convert the observed resistance value R_t at the current temperature t to the resistance value R_{t0} at the reference temperature t_0 .

*Requires temperature sensor (Z2001 or Z2002).

Reference temperature setting range: -10 °C to 99.9 °C
Temperature coefficient setting range: -9,999 ppm to +9,999 ppm

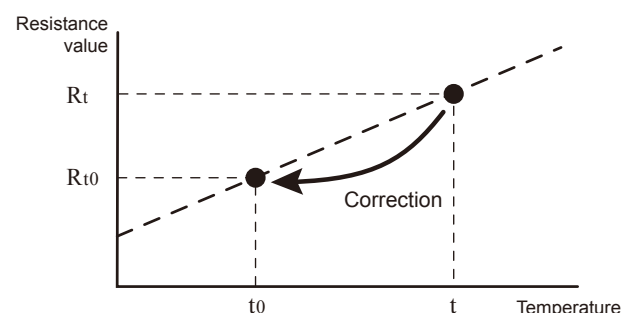

Easy-to-use RESISTANCE METER

suits both manual operation and integration with automatic lines



RM3544/RM3544-01

Features

- Simple, intuitive functions, screens, and operation for applications, including on production lines and in acceptance inspections
- High-durability probes with guard jack and increased measurement current for noise-resistant*1 measurement
- Quickly identifiable PASS/FAIL judgments with sound and light

*1 Compared to previous model (3540).

High-precision specs in a compact package

● Convenient range options

Measure from 0.000 mΩ to 3.5000 MΩ
1 μΩ max. resolution, 0.02% basic accuracy
Max. measurable current of 300mA

As inverter-equipped power supply equipment uses increasingly high currents and frequencies, increasingly low-resistance and low-loss inductors are being used in their circuitry, prompting a need for the ability to measure lower resistance levels with a high level of stability. With a resolution of 1 μΩ, the RM3544/RM3544-01 satisfies these needs.

Electronic components make extensive use of high-resistance substrates such as conductive sheets and rubber, and the RM3544/RM3544-01 delivers the ability to measure up to 3.5 MΩ.

Moreover, the instrument's maximum accuracy of 0.02% allows it to be used in testing current detectors with a precision of 0.1%.

● No warmup period or zero adjustment

The RM3544/RM3544-01 has no warmup time, meaning it's ready to use for measurement as soon as you turn it on. Accuracy is guaranteed immediately after the instrument is powered up (assuming temperature and humidity conditions that satisfy the accuracy guarantee conditions).

● Footprint of just 215 × 166 mm

Compared to previous the previous model (HIOKI 3540), the RM3544/RM3544-01 takes up approximately 25% less installation space. The smaller footprint creates work space in front of the instrument, and its compact size allows it to be easily and unobtrusively embedded in other equipment.



● High-durability probes

HIOKI offers a line of probes designed to accommodate the full range of measurement targets. Flex resistance has been dramatically improved (based on HIOKI comparisons).

Advanced functionality that's as easy to use as it is easy to understand

● Measurement jacks with guard jack

By connecting a probe to the guard jack, you can minimize the effects of external noise on measurements.

● Simple control over basic settings

Range and measurement speed can be controlled directly.

● Loud, user-selectable judgment tones

High-volume judgment tones of at least 85 dB inform the operator of test results, ensuring that they remain audible even in the vicinity of noisy machinery. The ability to choose from various tones ensures operators won't confuse judgment results on lines where multiple RM3544 units are in use.

● LED COMPARATOR ATTACHMENT (Option)

The LED Comparator Attachment indicates judgment results with green and red LEDs, eliminating the need to look at the instrument's screen and increasing work efficiency. Since the lamps do not light up when the measurement leads are open, the attachment can also be used to verify the connection status.

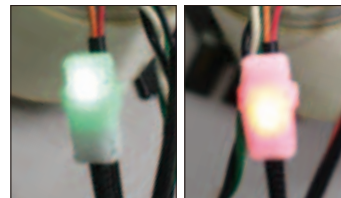

Green light
IN state

Red light
HI/LO state

● Material- and temperature-independent temperature correction function

The temperature correction function can be used to convert resistance values that vary with the ambient temperature to a reference value at a reference temperature using the Temperature Sensor Z2001 and a user-specified resistance temperature coefficient.

● Scaling

The scaling function can be used to convert resistance values into physical properties such as length.

Conversion formula : $R_s = A \times R + B$

A, B : Constants, R : Measurement value
 R_s : Resistance value

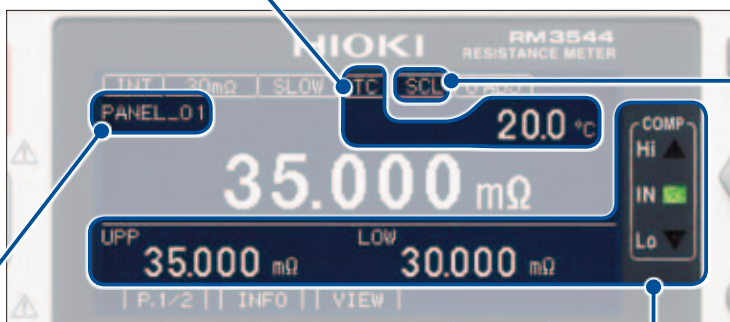

Intuitive, graphical LCD

● Panel save and load functionality for up to 10 sets of parameters

Panel save and load functionality provides the ability to save and subsequently load up to 10 sets of instrument setting conditions for range, comparator, and other parameters. Naming each set of panel data lets you make setup changes among production lots and lines smoothly and effortlessly.

● Comparator Function

The comparator function compares measured values to a previously set reference value or range and then displays and outputs the judgment result. The RM3544-01 can also output comparator results via its EXT I/O interface.

Acquiring measurement results (data)(RM3544-01)

RM3544-01 rear panel

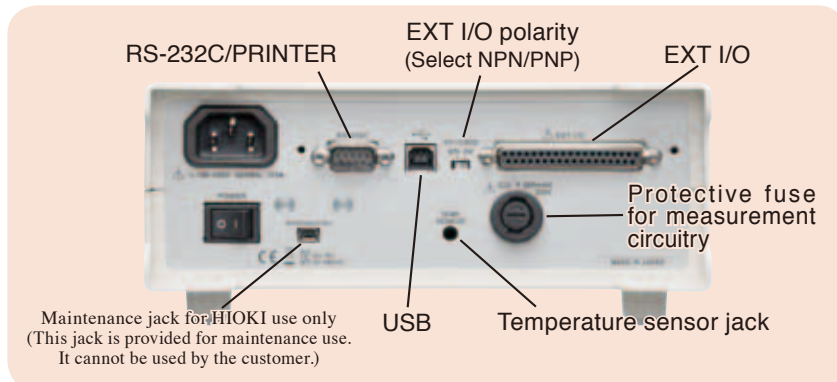

*The RM3544 does not include EXT I/O or communications interfaces (RS-232C or USB).

Connecting the instrument to a computer via RS-232C or USB

- The full range of RM3544-01 functionality can be controlled from a computer, which can also be used to acquire measurement results. (This capability does not include turning the instrument on and off or configuring certain interface settings.)
- By connecting the instrument to a commercially available RS-232C printer, it you can print measured values, including judgment results.
- Measured values can be automatically output. By using the instrument's USB keyboard mode, measured values can be entered into applications such as spreadsheets and text editors without the need to install a special USB driver in the computer.
- The sample PC application provides functionality for capturing data based on trigger signals, performing interval measurement, conducting communication tests, and loading captured data into Microsoft® Excel or outputting it as a CSV file. The application can be downloaded from Hioki's website (<http://www.hioki.com>).

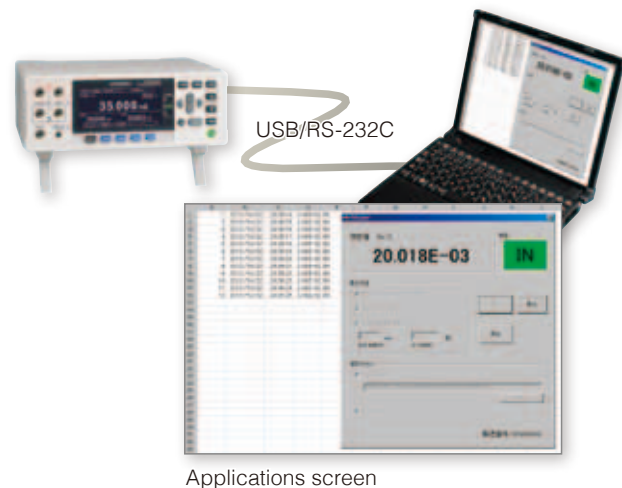

Applications screen

Communications monitor function for smooth system development

The communications monitor function displays communications data (received commands and sent data) on the screen, providing valuable support for programming of programmable logic controllers (PLCs).

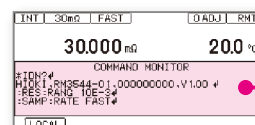

Communications Monitor screen

Enlarged view of communications data

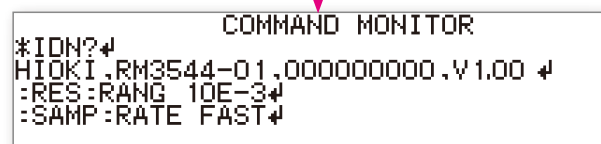

Universal power supply for robust accommodation of supply voltage fluctuations and automatic power supply frequency detection (RM3544/RM3544-01)

Measuring in sync with the power line frequency is important for achieving accurate measurements. To avoid measurement problems due to incorrect settings, the power line frequency is automatically sensed and selected (50 or 60 Hz).

The universal AC input (90 to 264 V) is practically unaffected by voltage fluctuations, so stable measurements are possible even in poor power environments.

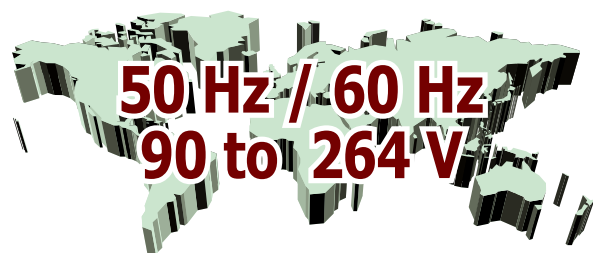

Easy integration into automatic testing equipment (RM3544-01)

High-speed, comprehensive productivity support

- The RM3544-01 delivers the speed demanded by automatic testing equipment at a sophisticated level. The entire process from the start of measurement to outputting of the judgment result takes as little as 18 ms. One cycle of operation, lasting from measurement to judgment output, completes within this time.
- The RM3544-01 supports RS-232C data communications at up to 115.2 kbps.
- The instrument's USB interface can also be used.
- The EXT I/O output mode can be switched between judgment mode and BCD mode.

Functionality for verifying the EXT I/O connection status and testing EXT I/O

In addition to allowing you to check EXT I/O signal input on the instrument's screen, this functionality allows you to turn output signals on or off as desired. This capability simplifies verification work during PLC programming.

Handler (EXT I/O) interface

The handler interface (EXT I/O) is isolated from measurement circuitry, control circuitry, and the protective ground (chassis ground), providing a high level of noise resistance.

Example of Typical EXT I/O Timing (EOM output hold)

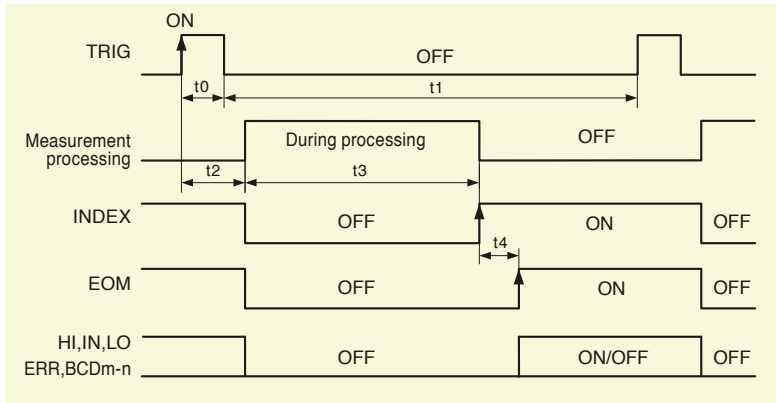

t0 : Trigger pulse ON time (0.1 ms or more)
 t1 : Trigger pulse OFF time (1 ms or more)
 t2 : Measurement start time (max. 1 ms)
 t3 : Capture processing time ; FAST(50Hz): 20.0 ms, FAST(60Hz): 16.7 ms, MEDIUM: 100 ms, SLOW: 400 ms
 t4 : Calculation time ; 1 ms

EXT I/O Input and Output Circuits

A switch on the rear panel is used to toggle the input signal polarity between NPN (sink output support) and PNP (source output support) settings depending on the PLC common polarity.



EXT I/O polarity (Select NPN/PNP)

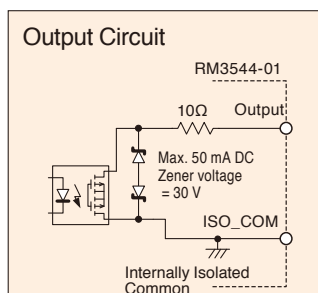
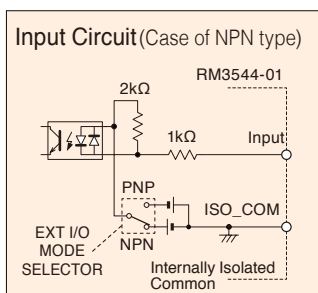

Measurement time*1

Measurement speed (ms)			
FAST		MED	SLOW
50Hz	60Hz		
21	18	101	401

Tolerance: ±10% ±2ms

*1 With TC set to ON and the comparator set to ON

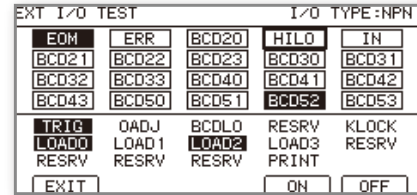

EXT I/O test function screen

When designing a control system using the EXT I/O interface, be sure to read the instruction manual and check the necessary technical information.

Example of Typical

Input Signals

- TRIG : External trigger
- OADJ : Zero-Adjust
- PRINT : Print
- KEY_LOCK : Key-Lock
- BCD_LOW : Lower digit specification when set to BCD output
- LOAD0 to LOAD3 : Panel number to load
- IN0, IN1 : General-purpose input pins

Output Signals

- HI, IN, LO : Comparator Hi, IN, LO
- EOM : End of Measurement
- INDEX : End of Import
- ERR : Measurement Fault Output
- HILO : Outputs HI or LO when set to BCD output.
- BCDm-n : Outputs the nth bit of the mth digit when set to BCD output.
- OUT0 to OUT2 : General-purpose output pins when set to judgment mode
- RNG_OUT0 to RNG_OUT3 : Outputs range information when set to BCD output.
- ISO_5V : Internally Isolated 5 V
- ISO_COM : Internally Isolated Common

EXT I/O Electrical Specifications

Inputs:

- Photocoupler isolation: Non-voltage contact inputs (support for current sink output)
- Input ON: Residual voltage: Max. 1 V @4 mA
- Input OFF: Open Max. 100 μA

Outputs:

- Photocoupler-isolated open drain output (no-polarity)
- DC30Vmax, DC50mAmax/ch
- Residual voltage: Max. 1 V @50 mA, or 0.5 V @10 mA

External power output:

- Output voltage: Sink output support: 5.0V±10%, Source output support: -5.0V±10%
- Max. output current: 100mA

High-accuracy portable RESISTANCE METER

measures from $\mu\Omega$ to $M\Omega$



RM3548

Features

- High-precision specs in a portable package (high accuracy of 0.02% rdg.)
- Design is ideal for maintenance and testing/measurement of large equipment.
- No warmup period or zero adjustment required.
- Dramatically improved overvoltage resistance (protection up to 70 V DC)

High-precision specs in a portable package

● Expansive range options

Measure from 0.0 $\mu\Omega$ to 3.5000 $M\Omega$

0.1 $\mu\Omega$ max. resolution, 0.02% basic accuracy

Max. measurable current of 1A

● Continuity and resistance measurement in large transformers, motors, and power supply equipment

The RM3548 uses a high current of 1 A to measure lower resistance values more reliably at a resolution of 0.1 $\mu\Omega$ in applications including measuring resistance in large transformers and motors as well as wiring, busbars and connections in power supply equipment.

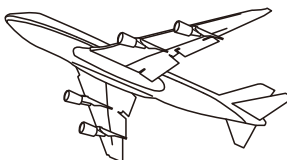
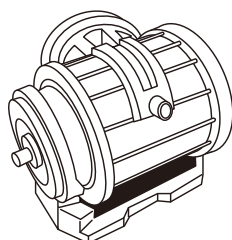
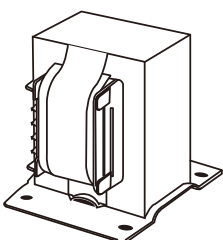

● Verification of continuity of ground lines in automobiles and fuselage welds and caulking in aircraft

The RM3548 can be used to check ground connections* in automobiles and fuselage welds and caulking in aircraft using a measurement current of 300 mA (300 m Ω range).

Portable, easy to use, and easy to understand

● Design is ideal for maintenance and testing/measurement of large products

The included strap can be looped around the neck to support the instrument, leaving the operator's hands free to hold probes for measurement. The meter uses eight AA alkaline batteries, which provide enough power for approximately 10 hours of testing under normal operating conditions. (Operating times vary with measurement conditions.)

● Auto-hold and auto-memory functionality

The RM3548 features auto-hold and auto-memory functionality to automatically hold and record data simply by placing the probes in contact with the desired measurement location. This functionality allows measured values to be recorded automatically as soon as they stabilize without the need for the user to operate any switches.

● LED COMPARATOR ATTACHMENT

By installing the LED COMPARATOR ATTACHMENT close to a probe, you can capture judgment results without moving your eyes away from the measurement location and probe.

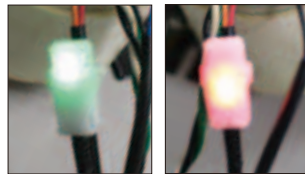

Green light
IN state

Red light
HI/LO state

● Offset Voltage Compensation(OVC)

Thermal EMF occurs at the contact point of different metals. This voltage affects measurements, and if large enough, can cause measurement errors. The offset voltage compensation function minimizes the effect of thermal EMF to maintain measurement accuracy. Particularly when measuring low resistances where the detection voltage is small, and during low-power resistance measurements, OVC is essential to maintain accuracy.

● Length conversion function

By setting a resistance value per meter, it is possible to convert resistance values into lengths. This capability is useful when managing cable inventory or estimating PCB pattern lengths.

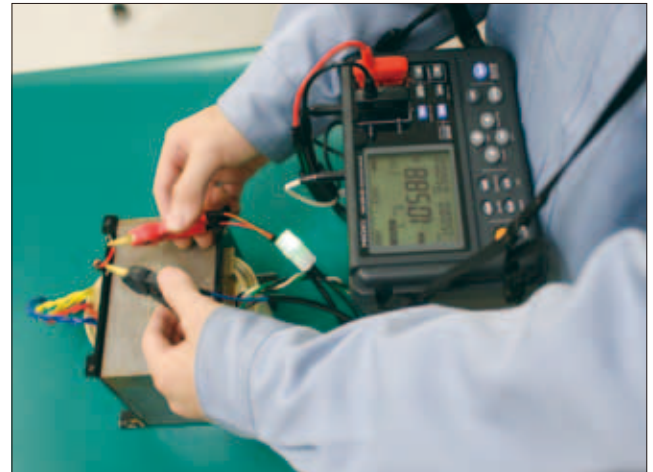

● No zero adjustment

Accuracy is defined without any need to perform zero-adjustment. Measurement can be performed as soon as the instrument is turned on.

● Dramatically improved overvoltage resistance

Protection is provided against overvoltage input of up to 70 V, preventing damage caused by connecting the instrument to an electrical charge or by the effects of the counter-EMF from inductance.



Circuit protection detection state
(Alerts the operator to overvoltage input with a screen display and an audible warning.)

● Acquire measured values recorded in the instrument's memory over a USB connection

By connecting the RM3548 to a computer with a USB cable*, you can download measured values stored in the instrument's memory.

*Since the RM3548 provides a mass storage class (read-only) USB interface, there is no need to install special driver software on the computer

Temperature conversion function and interval measurement: Useful in temperature-rise testing

Temperature increase (Δt) is obtained and displayed by converting resistance measurements and ambient temperature. The maximum temperature increase needs to be determined when current is applied especially for verifying motor windings or transformers. The interval measurement function can be used to take measurements at a user-specified interval from the start of measurement. Since measured values can be recorded in the instrument's memory, the maximum temperature can be easily estimated.

*The temperature conversion function cannot be used simultaneously with the temperature correction function and length conversion function.

- ① When a motor or coil has thermally stabilized at room temperature, measure the resistance (r_0) and ambient temperature (t_0) before applying current.
- ② Excite the coil, and when the temperature increase appears to saturate, remove the excitation.
- ③ After removing excitation, determine the temperature (Δt_1 to Δt_n) from the resistance (r_t) measured at each specific time (t), and the ambient temperature.
- ④ Project the curve through the collected temperature data (Δt_1 to Δt_n) to estimate the maximum temperature increase (Δt).

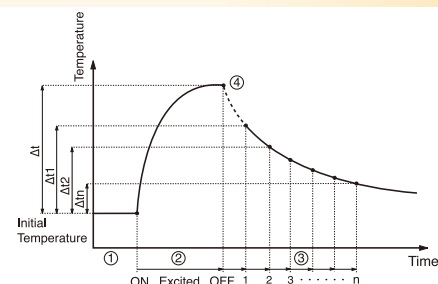

Measurement accuracy

Resistance measurement accuracy

Conditions of guaranteed accuracy

- Temperature & humidity: 23 °C ±5 °C, 80% rh or less (non-condensating)
- Accuracy guaranteed for 1 year, Post-adjustment accuracy guaranteed for 1 year
- From 0°C to 18°C and from 28°C to 40°C, add (temperature coefficient ±[1/10 measurement accuracy] / °C).

RM3544/RM3544-01

Accuracy = ±(% rdg. + % f.s.)

(f.s. = calculated 30,000 dgt., where 0.010% f.s. = 3 dgt.)

(Example) 0.020 + 0.007 0.020% rdg. + 0.007% f.s.

Range	Max. measurement display ^{1,2}	FAST	MED/SLOW	Measurement Current ³	Open-Circuit Voltage
30mΩ	35.000 mΩ	0.030+0.080	0.030+0.070	300mA	5.5V _{max.}
300mΩ	350.00 mΩ	0.025+0.017	0.025+0.014	300mA	
3Ω	3.500 0 Ω	0.025+0.017	0.025+0.014	30mA	
30Ω	35.000 Ω	0.020+0.010	0.020+0.007	10mA	
300Ω	350.00 Ω	0.020+0.010	0.020+0.007	1mA	
3kΩ	3.500 0 kΩ	0.020+0.010	0.020+0.007	1mA	
30kΩ	35.000 kΩ	0.020+0.010	0.020+0.007	100μA	
300kΩ	350.00 kΩ	0.040+0.010	0.040+0.007	5μA	
3MΩ	3.500 0 MΩ	0.200+0.010	0.200+0.007	500nA	

*1 For negative values, to -10% f.s.

*2 The maximum display range is 99,999dgt.

*3 Measurement current accuracy is ±5%.

RM3548

Accuracy = ±(% rdg. + % f.s.)

(f.s. = calculated 30,000 dgt., where 0.010% f.s. = 3 dgt.)

(Example) 0.020 + 0.007 0.020% rdg. + 0.007% f.s.

Range	Max. measurement display ^{4,5}	Accuracy ⁶	Measurement Current ⁷	Open-Circuit Voltage
3mΩ	3.500 0 mΩ	0.100 + 0.200 (0.100 + 0.020)	1A	5.5V _{max.}
30mΩ	35.000 mΩ	0.100 + 0.020 (0.100 + 0.010)		
300mΩ	350.00 mΩ	0.100 + 0.010 (0.100 + 0.010)	300mA	
		0.020 + 0.020 (0.020 + 0.010)	100mA	
3Ω	3.500 0 Ω	0.020 + 0.007 (0.020 + 0.007)	100mA	
30Ω	35.000 Ω	0.020 + 0.007 (0.020 + 0.007)	10mA	
300Ω	350.00 Ω	0.020 + 0.007 (0.020 + 0.007)	1mA	
3kΩ	3.500 0 kΩ	0.020 + 0.007		
30kΩ	35.000 kΩ	0.020 + 0.007	100μA	
300kΩ	350.00 kΩ	0.040 + 0.007	5μA	
3MΩ	3.500 0 MΩ	0.200 + 0.007	500nA	

*4 For negative values, to -10% f.s.

*5 The maximum display range is the same as the maximum measurement range.

*6 Measurement accuracy values assume offset voltage correction (OVC) is ON.

*7 Measurement current accuracy is ±5%.

* During temperature correction, the value calculated below is added to the rdg. error for resistance measurement accuracy:

$$\frac{-\alpha_{t0} \Delta t}{1 + \alpha_{t0} \times (t + \Delta t - t_0)} \times 100 \quad [\%]$$

t_0 : Reference temperature. [°C]
 t : Ambient temperature. [°C]
 Δt : Temperature. measurement accuracy
 α_{t0} : Temperature. coefficient at t_0 is [1/°C]

Temperature measurement accuracy

- Temperature Sensor Z2001 (for RM3544/RM3544-01)
- Temperature Sensor Z2002 (for RM3548)

- Temperature Sensor Z2001 and RM3544/RM3544-01 combined accuracy
- Temperature Sensor Z2002 and RM3548 combined accuracy

t: Temperature measurement values [°C]

Range of guaranteed accuracy	-10.0 to 99.9 °C
Display refresh rate	Approx. 2 s
Guaranteed accuracy period	1 year

Temperature	Accuracy
-10.0 °C to 9.9 °C	± (0.55 + 0.009 × t-10) °C
10.0 °C to 30.0 °C	± 0.50 °C
30.1 °C to 59.9 °C	± (0.55 + 0.012 × t-30) °C
60.0 °C to 99.9 °C	± (0.92 + 0.021 × t-60) °C

Standalone instrument accuracy: ± 0.2 °C

RM3544/RM3544-01/RM3548 Specifications

Product warranty: 1 year

	RM3544/RM3544-01	RM3548
Measurement types	Resistance measurement: 0.000mΩ (30mΩ range) to 3.500 0MΩ (3MΩ range), 9 ranges Temperature measurement (thermistor): -10.0 to 99.9°C	Resistance measurement: 0.000mΩ (3mΩ range) to 3.500 0MΩ (3MΩ range), 10 ranges Temperature measurement (thermistor): -10.0 to 99.9°C
Measurement method	4-terminal direct current (constant current), banana plug, with guard terminal	4-terminal direct current (constant current), banana plug
Range switching	Auto or Manual	
Temperature correction	Reference temperature setting range: -10°C to 99.9°C, Temperature coefficient setting range: -9,999 ppm/°C to +9,999 ppm/°C	
Zero-adjustment	Within -3% to 50% f.s. of each range. (f.s.= 30,000 dgt.)	Within ±3% f.s. of each range (f.s.= 30,000 dgt.)
Trigger	RM3544: Internal trigger, RM3544-01: Internal or external	Internal trigger
Measurement speed	FAST (50Hz:21 ms, 60Hz:18 ms) / MED (101 ms) / SLOW (401 ms)	Fixed
Display refresh rate	N/A	Without OVC: approx. 100ms, With OVC: approx. 230ms
Delay	N/A	Internal fixed value: / 10 to 1000ms (7 settings)
Functions	Temperature correction, comparator (ABS/REF%), key-lock (OFF, menu lock, all lock), display digit count selection function (5 digits/4 digits), automatic power supply frequency settings (AUTO/50Hz/60Hz), scaling, judgment sound setting, auto hold	Temperature correction, temperature conversion, offset voltage compensation (OVC), comparator (ABS/REF%), length conversion, judgment sound setting, auto hold, auto power save (APS)
Measurement fault detection functions	Over-range detection, current fault detection, fuse trip detection	Over-range detection, current fault detection, circuit protection detection function, fuse trip detection
Averaging	OFF, 2 to 100 averaging iterations (variable in 1-iteration steps)	OFF, 2/5/10/20 averaging iterations
Panel store, panel load	10 Panel save parameters: resistance measurement ranges, measurement speed, average, comparator, judgment sound, scaling, temperature correction(TC), auto hold, zero-adjust	9
Memory storage	N/A	Manual, Auto memory, interval memory Number of blocks: 10 Number of recordable data points: (manual/auto) Up to 1,000, (interval) Up to 6,000 Interval: 0.2 to 10.0s (0.2s steps) Acquisition of data from memory: display, USB mass storage (CSV, TXT files)
Interfaces	RM3544-01: EXT I/O, Communication interface	Communication interface
Communication interfaces	RM3544-01: Select from RS-232C, PRINTER(RS-232C), or USB	USB
Communication function	Remote function, communications monitor function, data output function	N/A
RS-232C	Bit rates: 115,200 / 38,400 / 19,200 / 9,600 bps	N/A
USB	Class: CDC (COM mode), HID (USB keyboard mode)	Class: USB mass storage class (read-only)
Printer	Operation: Prints at PRINT signal or PRINT key input. Printed data: Resistance measurement values, temperature measurement values, judgment results, measurement conditions Interval: ON/OFF Interval times: 1 to 3,600 s (variable in 1 s steps) Number of print columns per row: 1 or 3	N/A

General specifications

	RM3544/RM3544-01	RM3548
Operating temperature and humidity	0 to 40°C, 80% rh or less (non-condensating)	
Storage temperature and humidity	-10 to 40°C, 80% rh or less (non-condensating)	
Operating environment	Indoors, Pollution Degree 2, up to 2,000 m ASL	
Power supply	Rated supply voltage: 100 to 240 VAC ±10% Rated supply frequency: 50/60 Hz	DC1.5V × 8 (LR6 alkaline battery × 8)
Continuous operating time	N/A	1 s measurements over 10 s in 3 mΩ range: Approx. 10 hours (when using new alkaline batteries)
Rated power consumption	15 VA	5 VA
Insulation withstand potential	1.62 kV AC for 1 min. (with 10 mA cutoff current) between all mains supply terminals and protective ground, interfaces, and measurement jacks	N/A
Dimensions	Approx. 215W × 80H × 166D mm (8.46"W × 3.15"H × 6.54"D) (without projections)	Approx. 192W × 121H × 55D mm (7.56"W × 4.76"H × 2.17"D) (without projections)
Mass	RM3544: Approx. 0.9 kg (31.7 oz) RM3544-01: Approx. 1.0 kg (35.3 oz)	Approx. 0.77 kg (27.2 oz.)
Accessories	RM3544: Power cord ×1, CLIP TYPE LEAD L2101 ×1, instruction manual ×1, spare fuse ×1 RM3544-01: Power cord ×1, CLIP TYPE LEAD L2101 ×1, male EXT I/O connector ×1, instruction manual ×1, application disc ×1, USB cable (A-to-B type) ×1, spare fuse ×1	CLIP TYPE LEAD L2107 ×1, TEMPERATURE SENSOR Z2002 ×1, LR6 alkaline battery ×8, instruction manual ×1, USB cable(A-to-mini B type) ×1, strap ×1, spare fuse ×1
Applicable standards	Safety: EN61010 EMC: EN61326, EN61000-3-2, EN61000-3-3	Safety: EN61010 EMC: EN61326

Model Configurations and Options



Model : RESISTANCE METER RM3544

Model No. (Order Code) (Note)

RM3544 (Interface less)

RM3544-01 (with EXT I/O, RS-232C, USB)

Accessories: [RM3544] Power cord ×1, Clip type lead L2101 ×1, Instruction manual ×1, Spare fuse ×1, [RM3544-01] Power cord ×1, Clip type lead L2101 ×1, Male EXT. I/O connector ×1, Instruction manual ×1, Application disc ×1, USB cable (A-to-B type) ×1, Spare fuse ×1



Model : RESISTANCE METER RM3548

Model No. (Order Code)

RM3548

Accessories: Clip type lead L2107 ×1, Temperature sensor Z2002 ×1, LR6 Alkaline battery ×8, Instruction manual ×1, USB Cable(A-to-mini B type) ×1, Strap ×1, Spare fuse ×1

Caution when considering the use of probes without guard terminals

Proper operation of the RM3544 is not guaranteed when using test leads (test probes) that lack guard terminals, for example test leads used with models such as the Resistance HiTester 3541 or mΩ HiTester 3540. Please use the test leads indicated in the RM3544 accessory and option documentation.

Shared option



LED COMPARATOR ATTACHMENT L2105
2 m (6.56 ft.)

Probe Lengths

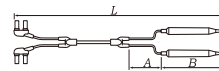

A : Junction-to-probe

B : Probe

L : Overall length

*Since the L2101 to L2104, L2107 leads can be separated into two units, length A is not noted

Options for RM3544/RM3544-01



CLIP TYPE LEAD L2101
(Bundled accessory)
B:83 mm (3.27 in.), L:1.5 m (4.92 ft.)

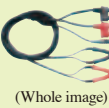

4-TERMINAL LEAD L2104
B:118 mm (4.65 in.), L:1.5 m (4.92 ft.)

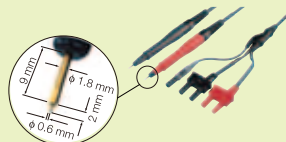

PIN TYPE LEAD L2102
B:178 mm (7.01 in.), L:1.5 m (4.92 ft.)

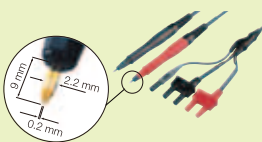

PIN TYPE LEAD L2103
B:176 mm (6.93 in.), L:1.5 m (4.92 ft.)

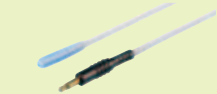

TEMPERATURE SENSOR Z2001
1.75 m (5.74 ft.)

PC Communication (for RM3544-01)

RS-232C CABLE 9637
for PC connection, 9pin - 9pin, cross, 1.8 m (5.91 ft.)

RS-232C CABLE 9638
for PC connection, 9pin - 25pin, cross, 1.8 m (5.91 ft.)

Options for RM3548



CLIP TYPE LEAD L2107
(Bundled accessory)
B:83 mm (3.27 in.), L:1.1 m (3.61 ft.)



FOUR TERMINAL LEAD 9453
A:280 mm (11.02 in.), B:118 mm (4.65 in.), L:1.36 m (4.46 ft.)

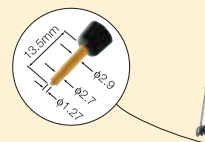

PIN TYPE LEAD 9465-10
A: 45 mm (1.77 in.) (Red), 105 mm (4.13 in.) (Black, Max. 515 mm (20.28 in.)), B: 176 mm (6.93 in.), L: 1.88 m (6.17 ft.)

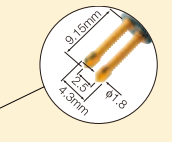

PIN TYPE LEAD 9772
A: 45 mm (1.77 in.) (Red), 105 mm (4.13 in.) (Black, Max. 515 mm (20.28 in.)), B: 173 mm (6.81 in.), L: 1.88 m (6.17 ft.)



TEMPERATURE SENSOR Z2002
(Bundled accessory)
100 mm (3.94 in.)



LARGE CLIP TYPE LEAD 9467
A:300 mm (11.81 in.), B:116 mm (4.57 in.), L:1.36 m (4.46 ft.)



CARRYING CASE C1006

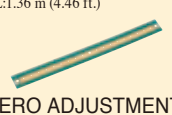

ZERO ADJUSTMENT BOARD 9454
for 9465-10

HIOKI

HIOKI E. E. CORPORATION

HEADQUARTERS

81 Koizumi, Ueda, Nagano, 386-1192, Japan
TEL +81-268-28-0562 FAX +81-268-28-0568
http://www.hioki.com / E-mail: os-com@hioki.co.jp

HIOKI USA CORPORATION

TEL +1-609-409-9109 FAX +1-609-409-9108
http://www.hioki.com / E-mail: hioki@hioki.com

Note: Company names and Product names appearing in this catalog are trademarks or registered trademarks of various companies.

HIOKI (Shanghai) SALES & TRADING CO., LTD.
TEL +86-21-63910090 FAX +86-21-63910360
http://www.hioki.cn / E-mail: info@hioki.com.cn

DISTRIBUTED BY

HIOKI SINGAPORE PTE. LTD.
TEL +65-6634-7677 FAX +65-6634-7477
E-mail: info-sg@hioki.com.sg

HIOKI KOREA CO., LTD.
TEL +82-2-2183-8847 FAX +82-2-2183-3360
E-mail: info-kr@hioki.co.jp