

FUZZY Universal Controller with total configuration 1/8 DIN - 48 x 96 mm XF line

Intelligent

The XF universal controller ensures exact control under all conditions even on critical processes, thanks to the FUZZY algorithm control.

Truly universal

Universal input: for thermocouples, resistance thermometers, mA and Volt.
Universal output: switching (relay and logic) continuous (mA and Volt) and three point stepping (for electric actuators).
Universal control algorithm connecting PID and FUZZY actions.

The unique, truly Universal, all inclusive controller, totally configurable from keyboard and serial interface.



E

Certified ISO 9001

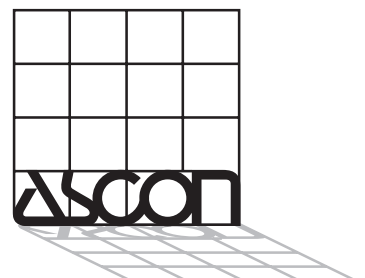

ASCON spa

20021 Bollate - (Milano) Italy - Via Falzarego, 9/11 - Tel. +39 02 333 371 - Fax +39 02 350 4243
<http://www.ascon.it> e-mail info@ascon.it

The XF Series controller

The Intelligence of the **FUZZY** algorithm by ASCON at the service of both process and operator.

For this universal instruments, ASCON has set up an innovative control technique based on **FUZZY** logic combined with standard PID algorithm for the control of industrial processes.

Binary logic

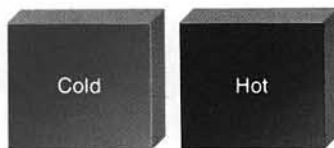

FUZZY shaded logic



WHAT IS **FUZZY**

The **FUZZY** logic, that means "shaded" logic, uses some concepts of artificial intelligence, based upon a block of rules permitting action not determined by binary states (for instance: black/white, open/closed, heat/cool) but on the evaluation of intermediate states (for instance: hot, warm, tepid, cool, cold).

This operating mode is similar to human reasoning, with shades leading to more realistic evaluations and, therefore, better corrective actions.

FROM PID TO **FUZZY**

The standard PID control algorithm uses a mathematical formula to be parameterized (P, I and D values) in function of the characteristics of the process to be controlled (gain and time constants).

By comparison, the **FUZZY** algorithm selects, through a complex group of rules, the mode of action depending upon the process under the various operating conditions, reacting quickly according to the needs.

WHY PID - **FUZZY**

With the XF controller, ASCON offers the maximum control flexibility to the operators.

It's, in fact, possible to freely set the control algorithm starting from the standard PID and combining it with the desired percent of **FUZZY**

PID action integrated by **FUZZY** control is able to react quickly and without unwanted oscillations to load and set point changes.

PID-**FUZZY** combination allows good control of difficult processes, especially in the presence of changes to the operating conditions, it makes possible the control of very critical processes, practically impossible to control with the standard PID.

Comparison of step response curves between PID algorithm and ASCON **FUZZY** algorithm in different operating conditions.

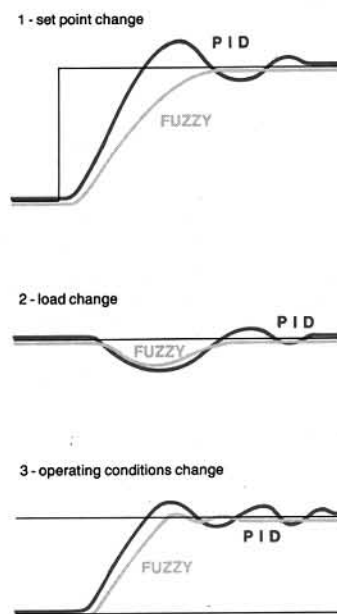

Note: PID parameters have been optimized before the change.

Controller computes automatically the **FUZZY parameters, starting from the set PID parameters. The factory set PID-**FUZZY** parameters are applicable for the most part of processes. Automatic searching and loading of the optimum values can be carried out through the launching of the automatic self-tuning procedure. The PID-**FUZZY** combination is a truly universal control algorithm suitable to control any process efficiently. Only one controller for all the applications at the service of both process and operator.**

Serial communication.

Optional. For the access to all the parameters. For connecting, via a serial port RS232 or RS422 or RS485, up to 64 controllers into a supervisory system.

Universal power supply

from 100 to 240 Vac or 24 Vac or 24 Vdc.

Auxiliary power supply

For external transmitter.

Isolated retransmission output

Optional. For the retransmission of process value, set point or as second control output.

3 logical inputs

For the change of the operating states - Auto/man, Loc/Rem, or for the recall of one of the 4 stored set points.

2 relay auxiliary outputs

With independent, deviation or band set point. It's also possible monitoring and signalling function of any failure in the control loop (Loop-Break-Alarm).



Maximum protection

Very high immunity to interference, guided procedures and 3 different access level to parameters. Front protection IP54 or IP65.

Universal input

For thermocouples (J,L,K,S,R), Pt100 and standard signals in mA and Volt.

Set Point

The instrument can operate with Local Set point, Remote set point, or with a set point selected between 4 stored values.

Set point change can be gradual, setting up and down desired gradient.

Main universal output

Galvanically isolated, with single or dual action (Heat-Cool), to select within the 5 built-in possible functions: relay, logic, continuous (mA or Volt) and three point stepping.

Total configurability from keyboard and serial interface

All possible functions are standard, the controller only needs to be configured according to the application. Total configurability allows setting up of the following parameters: input, scale range, type of main control output with safety state, set point, 2 auxiliary outputs and retransmission output.

truly Universal,
all included and.....
...with **FUZZY** control

Technical data

UNIVERSAL INPUT

The following function can be configured from the keyboard:

- type of input signal
- scale range
- zero and full scale value

Common features

- A/D converter: 50.000 points
- Sampling time: 0,5 sec.
- For change of power supply within 100 and 240 Vac the error is negligible
- Input shift: -50 ... +50 digits
- Measure filtering: 0...30 sec

For thermocouples

- Cold junction built-in
- Line resistance: 15 Ω max
- Accuracy: 0,2% \pm 1°C at 25 °C
- Measurements drift:
 - < 2 μ V/°C ambient temperature
 - < 5 μ V/10 Ω line resistance

For Pt100 thermoresistance

- 2 or 3 wire connection
- Line resistance: 20 Ω max for 3 wire connection
- Accuracy: 0,2% at 25°C
- Measurement drift:
 - < 0,1°C/10°C ambient temperature
 - < 0,5°C/10 Ω line resistance (3 wire)

Standard dc signals

- Input resistance:
 - current: 15 Ω ; voltage: 10k Ω
- Accuracy: 0,1% at 25°C
- Measurement drift:
 - < 0,1%/20°C ambient temperature

MAIN UNIVERSAL OUTPUT Y1

Can be configured single or dual, with direct or reverse operation; upper and lower limits can be set within 10...100%.

Following features are always present:

Relay: 1 NO contact, 5A/250 Vac

Logic voltage:

0/18 Vdc \pm 10%, 20 mA max, isolated, suitable for driving relays and static contactors

Continuous (direct current)

4...20 mA isolated, 500 Ω max (10 V max)

Continuous (direct voltage)

0...10 Volt, isolated, 500 Ω min (20 mA max)

Short circuit proof.

Three point stepping (for electric actuators)

3 positions: open-stop-close
2 interlocked NO contacts, 5A/250 Vac

Dual action

For processes with "dual action" output Y1 (for example Heat-cool), it's

available an extra output with relay, 1 NO contact, 5A/250 Vac. Possible combinations for Y1 dual are:

Y1 Heat	R	L	L	R	C	R	C	L	C
Y1 Cool	R	R	L*	L*	R	C	C	C	L*

R = Relay; L = Logic;
C = Continuous (mA or Volt);
* version on request

For Y1 cool, R is the extra relay of Y1, while C is the retransmission output Y4 configured to retransmit Y1 cool: 4...20 mA or 0...10 Volt.

AUXILIARY OUTPUTS Y2, Y3 AND Y4

Y2 and Y3 actions (see fig. 2)

For Y2 and Y3 following functions are configurable:

- The control mode: active high or active low (i.e. relay energized above or below the threshold)
- The type of set point (in respect of W1)
 - Deviation: from -300 to +300 steps
 - Independent: within the scale span
 - Band: from 0 to 300 steps (with or without startup inhibition, see fig. 3)
- Output: 1 NO contact, 5A/250 Vac
- Hysteresis: from 0,01 to 10,00%
- **Note** - The setting range of set point for Y2 and Y3 is not limited by the limits of main set point W1 but only by the scale ends.

Y4 retransmission output

- Retransmitted signal: process value x, set point W1 or Y1 cool (only for Heat-Cool controllers)
- Output: 4...20 mA, 10V max or 0...10V, 20 mA max
- Accuracy: 0,1% at 25°C
- Resolution: 12 bit (0,025%)
- Isolation: 500 VAC/1' referred to input

UNIVERSAL CONTROL

The control algorithm features On-Off, PID-FUZZY, PID (I and D actions can be excluded).

Parameters:

- Proportional band: from 0,5 to 1000%
- Integral time: from 0,1 to 100 minutes
- Derivative time: from 0,01 to 10 minutes
- **FUZZY** intensity: from 0 to 90%

For On-Off control with hysteresis

- Hysteresis: from 0,1 to 10%

For time proportional controls

- Cycle time: from 1 to 200 seconds

For dual action controls

- Cycle time and output limits can be separately set for the 2 channels
- Dead zone between the two control actions: from \pm 5,0% of Y1 (see fig.1)

Fig. 1: Output characteristic for dual action controllers. Example: Heat - Cool

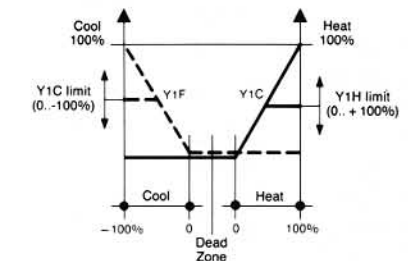

Y1C = Cool output (---)
Y1H = Heat output (—)
Indication for Y1: -100%... +100%

Fig. 2: Auxiliary control outputs Y2 and Y3

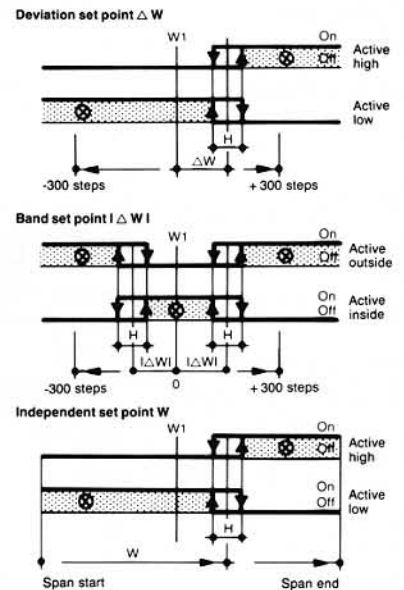

Note:
W1: Main set point
H: Auxiliary outputs hysteresis

Fig. 3: Auxiliary control output Y2 and Y3 with inhibited startup

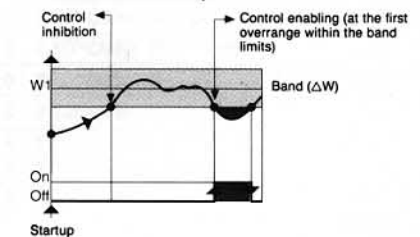
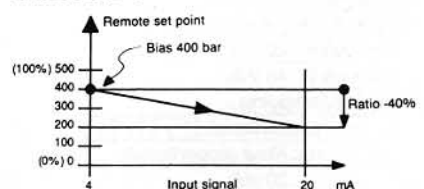

Fig. 4: Example of Bias and Ratio setting for a Controller with scale range 0...500 bar



Connections and overall dimensions

For three point stepping control

- Actuator response time: from 15 to 600 sec.
- Minimum correction step: from 0,1 to 10% of the useful travel (resolution on positioning)
- Potentiometer (for position retransmitting only): 100...10 kΩ (with possible automatic calibration)

SET POINT

- It's possible to set:
- upper and lower limits
 - up and down gradients from 0,1 to 100 digits/min

Remote set point (see fig. 4)

- 3 parameters allow:
- summing of local to remote set point
 - setting of bias, in engineering units
 - setting of ratio, from -100 to 100%
- Input: 4...20 mA on 15Ω or 0...10V on 330 kΩ
 - Accuracy: 0,1% at 25°C

Stored set points

- Up to 4 values, that can be recalled from keyboard, logical contacts or serial interface

AUTO/MAN STATION

- Built-in with bumpless action
- AUTO/MAN change via keyboard, logical input or serial interface

POWER SUPPLY FOR TRANSMITTER

- To supply a two wire transmitter 4...20 mA or a 3 wire 24 Vdc transmitter

SERIAL COMMUNICATION

- Passive isolated interface
- ASCII code/Modbus-Jbus
- Baud rate configurable between: 600, 1200, 2400, 4800 or 9600 (only for Modbus/Jbus) Bit/s
- Interface with RS232C, RS422A, RS485 port via traffic concentrator ALS type (it's possible to connect up to 64 ASCON instruments, also of different type) or direct RS485 port with Modbus/Jbus protocol

PROTECTIONS

- Input: the measure overrange or a failure on the input line (break or short circuit) is displayed and forces the outputs to the value of the safety state selected within configuration.
- Safety state: Main output Y1: -100... +100% Conf. Auxiliary outputs Y2 and Y3: 0 to 100% or disabled
- Parameters: are password protected and divided into 3 groups configurable as:
 - visible and alterable
 - visible but not alterable
 - masked and not alterable

CONNECTIONS

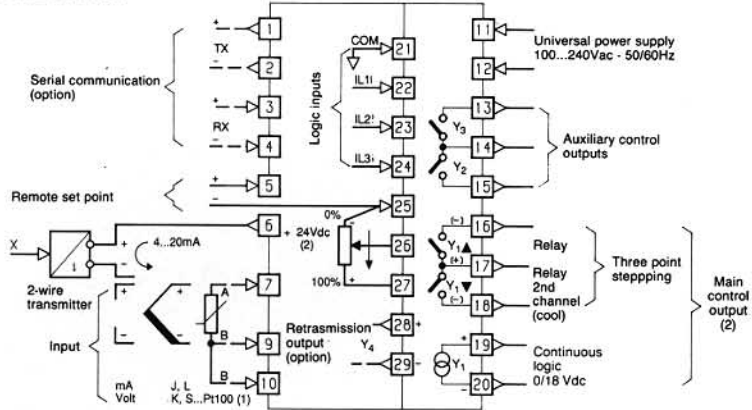

Notes:

- 1 To supply a 3 or 4 wire transmitter, use terminals 6 (+) and 9 (-)
- 2 Main control output Y1 can be selected within the 5 built-in possible functions: relay (terminals 16 and 17), logic or continuous 4...20 mA or 0...10 Volt (terminals 19 and 20) and three point stepping (terminals 16, 17 and 18).

OVERALL DIMENSIONS

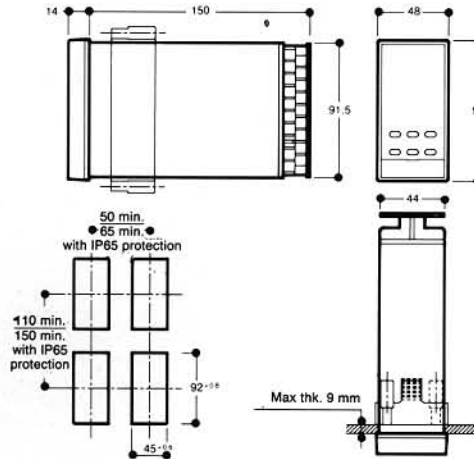

GENERAL CHARACTERISTICS

- Power supply: 100...240 V, 50/60 Hz, -15 + 10% (250V max) or 16...28V, 50/60 Hz and 20...30 Vdc
- Power consumption: 4 VA max
- Isolation group C to VDE 0110
- Climatic category: KWF to DIN 40040
- Ambient operating temperature: 0 to 50°C
- EMI suppression: Level IV to IEC 801-4 (for heavy conditions)
- Protection mode to DIN 40050 front panel: IP54 housing: IP30 terminals: IP20
- Housing material UL94 V1
- Weight: approx. 0,6 kg

- Dimensions: 48 x 96, depth. 150 mm (behind panel)

ACCESSORIES

- SERIAL COMMUNICATION INTERFACE for 64 ASCON instruments

Model: ALS — [] / []
 Power supply
 100...240V, 50/60 Hz
 16...28V, 50/60 Hz

Interface

- RS232
- RS422
- RS485

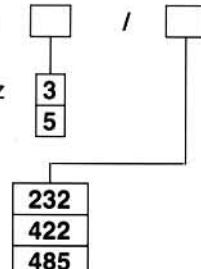

- FRONT PROTECTION KIT IP65: mod. F10-170-2A101

Models and configurations

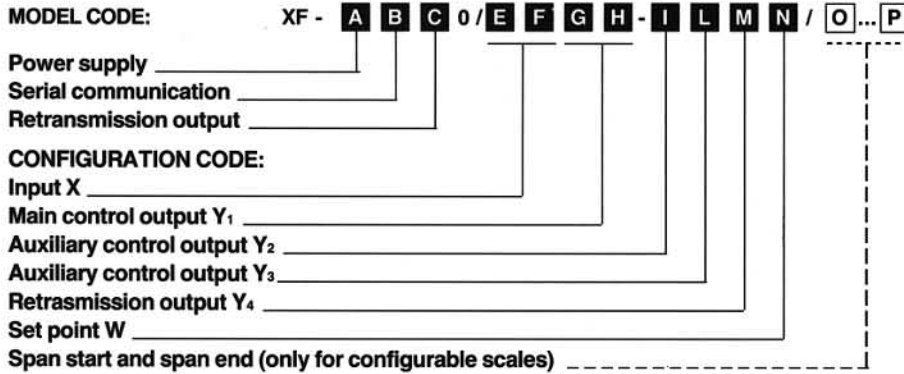

MODEL CODE:

Power supply	A
100...240 V 50/60 Hz	3
16...28 V 50/60 Hz e 20...30 Vdc	5

Serial communications	B
None	0
20 mA C.L. Ascon std. protocol	1
20 mA C.L. Modbus/Jbus protocol	2
RS485 port Modbus/Jbus protocol	3

Retransmission output Y ₄	C
None	0
Fitted (4...20 mA or 0...10 Volt)	1

CONFIGURATION CODE: (1)

Input type, scale range (2)	E	F
Thermoresistance Pt100Ω at 0°C IEC 751	-200...600°C	0 0
	Conf. -200...600°C	0 2
Thermocouple J Fe-Cu/Ni IEC 584	-99,9...300,0°C	1 0
	Conf. -99,9...300,0°C	1 2
Thermocouple L Fe-Const DIN 43710	0...600°C	2 0
	Conf. 0...600°C	2 2
Thermocouple K Cromel-Alumel IEC 584	0...1200°C	4 0
	Conf. 0...1200°C	4 2
Thermocouple S Pt10% Rh-Pt IEC 584	0...1600°C	5 0
	Conf. 0...1600°C	5 2
Thermocouple R Pt13% Rh-Pt IEC 584	0...1600°C	6 0
	Conf. 0...1600°C	6 2
4...20 mA	Conf. eng. units	7 4
0...20 mA	Conf. eng. units	7 5
0...1 Vdc	Conf. eng. units	7 6
0...10 Vdc	Conf. eng. units	7 7

Type of main output Y ₁ (3)	G
Relay (on-off with hysteresis)	0
Relay (time proportional)	1
Logic 0/18 Vdc (time proportional)	2
Continuous 4...20 mA	3
Continuous 0...10 Vdc	4
Three point stepping	5
Relay (time proportional) *	6
Logic 0/18 Vdc (time proportional) *	7
Continuous 4...20 mA *	8
Continuous 0...10 Vdc *	9

Type of operation and safety Y ₁ (4)	H
Reverse Safety 0%	0
Direct Safety 0%	1
Reverse Safety 100%	2
Direct Safety 100%	3
Reverse Safety -100% *	4
Direct Safety -100% *	5
Reverse Safety Conf. (4)	6
Direct Safety Conf. (4)	7
Reverse Safety Off.	8
Direct Safety Off.	9

Type of Set point and control mode of output Y ₂	I	
Disabled	0	
Banda with inhibited Start up	Active high	1
	Active low	2
Band	Active outside	3
	Active inside	4
Independent	Active high	5
	Active low	6
Deviation	Active high	7
	Active low	8

Type of Set point and control mode of output Y ₃	L	
Disabled	0	
Band with inhibited Start up	Active high	1
	Active low	2
Band	Active outside	3
	Active inside	4
Independent	Active high	5
	Active low	6
Deviation	Active high	7
	Active low	8
Loop - Break - Alarm	9	

Retransmission output Y ₄	M	
None (5)	0	
4...20 mA	Retransmission process value X	1
	Retransmission Set point W	2
	Retransmission Y ₁ cool (6)	3
0...10 Vdc	Retransmission process value X	4
	Retransmission Set point W	5
	Retransmission Y ₁ cool (6)	6

Type of Set point	N
1 local	0
1 local and remote 4...20 mA	1
1 local and remote 0...10 Vdc	2
1 local + 4 stored	3

Notes on configuration

1 - To receive a non-configured instrument, indicate code **9999-9999**.

2 - For Pt100 and thermocouple inputs with configurable scale, we suggest to select significant and round number scale ranges (-50...150°C, 0...40°C). The minimum settable span should not be less than 25% of the maximum span. Keep in mind that within the selected range, it is possible to limit the Set point adjustment range between the 2 lower and upper values. For mA and Volt inputs, span start and span end values can be configured in engineering units between -999 and 9999. The minimum scale span is 100 steps.

The values can be expressed in units (xxxx), in tenths (xxx.x), hundredths (xx.xx) or thousands (x.xxx).

In the absence of indications the instrument will be supplied with 0.0...100.0 scale.

3 - In order to set some types of output, it is also necessary to set a switch located inside the instrument.

For heat-cool control, select the outputs with * from (G-6) to (G-9).

4 - The safety state is the value of Y₁ in case of failure in the control loop. In practice it is the value defining the upper limit of Y₁. Safety states with * (H-4) or (H-5) impose the maximum limit to Cool action.

5 - Excluding the retransmission output option (C-0) means selecting (M-0) in configuration.

6 - The retransmission of Y₁ Cool (M-3) and (M-6) is used, for instance, for controlling a modulating valve.

Change from 4...20 mA to 0...10V can be done by moving a jumper inside the instrument.

Ordering examples:

XF-3100/4010-8700
configuration with defined scale range.

XF-3010/7430-5913/50.0...150.0
configuration with scale range in engineering units.

XF-3100/9999-9999
not configured.