

ATR243



REGOLATORE
Manuale Installatore

CONTROLLER
User Manual

PIXSYS



Summary

| | | |
|------|---|----|
| 1 | Introduction | 3 |
| 2 | Model Identification..... | 3 |
| 3 | Technical Data..... | 4 |
| 3.1 | General Features..... | 4 |
| 3.2 | Hardware Features..... | 4 |
| 3.3 | Software Features | 5 |
| 4 | Dimensions and Installation..... | 5 |
| 4.1 | Panel Assembly..... | 6 |
| 4.2 | Electronics Removal..... | 6 |
| 5 | Electrical wirings | 7 |
| 5.1 | Wiring diagram | 7 |
| 6 | Display and Key Functions | 13 |
| 6.1 | Numeric Indicators (Display) | 13 |
| 6.2 | Meaning of Status Lights (Led) | 13 |
| 6.3 | Keys..... | 14 |
| 7 | Controller Functions..... | 14 |
| 7.1 | Modifying Main Setpoint and Alarm Setpoint Values | 14 |
| 7.2 | Auto-Tune | 15 |
| 7.3 | Manual Tuning..... | 15 |
| 7.4 | Automatic Tuning..... | 15 |
| 7.5 | Soft Start..... | 16 |
| 7.6 | Automatic/Manual Regulation for % Output Control | 16 |
| 7.7 | Pre-Programmed Cycle..... | 17 |
| 7.8 | Memory Card..... | 18 |
| 8 | LATCH ON Functions | 19 |
| 8.1 | Loop Break Alarm On Amperometric Transformer..... | 21 |
| 8.2 | Digital Input Functions..... | 22 |
| 8.3 | Dual Action Heating-Cooling | 23 |
| 9 | Serial Communication..... | 25 |
| 10 | Configuration | 30 |
| 10.1 | Modify Configuration Parameter..... | 30 |
| 11 | Table of Configuration Parameters..... | 31 |
| 12 | Alarm Intervention Modes..... | 44 |
| 13 | Table of Anomaly Signals..... | 49 |
| 14 | Summary of Configuration parameters..... | 50 |

1 Introduction

Thank you for choosing a Pixsys controller.

With the ATR243 model Pixsys makes available in a single device all the resources relevant to sensor input and actuators command, in addition to the extended power range 24...230 Vac/Vdc. With 18 sensors to select and outputs configurable as relay, SSR command, 4...20 mA and 0...10Volt, the user or retailer can reduce warehouse stock by rationalising investment and device availability. The series is completed with models equipped with serial communication RS485 Modbus RTU and with a loading control function via the amperometric transformer. The configuration is further simplified by the Memory cards which are equipped with internal battery and therefore don't require cabling to power the controller.

2 Model Identification

The range of ATR243 controllers comes in three versions. Refer to the table below to easily select your preferred model.

| Models available, with power 24...230 Vac/Vdc +/-15% 50/60Hz – 3VA | |
|--|---|
| ATR243-20-ABC | 2 relays 5A or 1 relay + 1 Ssr/V/mA |
| ATR243-21-ABC-T | 2 relays 5A + 1 Ssr/V/mA + Rs485 +amperometric transformer* |
| ATR243-31-ABC | 3 relays 5A + 1 Ssr/V/mA + amperometric transformer* |

* Models with amperometric transformer input for Loop break alarm function.

3 Technical Data

3.1 General Features

| | |
|------------------------------|---|
| <i>Displays</i> | 4 0.40 inch displays + 4 0.30 displays |
| <i>Operating temperature</i> | 0-45°C, humidity 35..95uR% |
| <i>Sealing</i> | IP65 front panel (with gasket) IP20 casing and terminals |
| <i>Material</i> | PC ABS UL94VO self-extinguishing |
| <i>Weight</i> | 165 g (-20ABC) / 185 g (-21/31ABC) |

3.2 Hardware Features

| | | |
|-----------------------|---|---|
| <i>Analogue input</i> | 1: AN1 Configurable via software Input Thermocouple type K, S, R, J Automatic compensation of cold junction from 0°C to 50°C. Thermoresistance: PT100, PT500, PT1000, Ni100, PTC1K, NTC10K (β 3435K) Linear: 0-10V, 0-20 or 4-20mA, 0-40mV, amperometric transformer 50mA, 1024 points on version ATR243-21/-31 Potentiometers: 6K, 150K, | Tolerance (25°C) +/-0.2 % \pm 1 digit for thermocouple input, thermo resistance and V/mA. Cold junction accuracy 0.1°C/°C |
| <i>Relay output</i> | 2 relays (Atr243-20...-21...) 3 relays (Atr243-31...) Configurable as command and/or alarm output | Contacts 5A-250V~ |
| <i>SSR output</i> | 1 linear 0/4...20mA /SSR/0...10Volt >deselecting OUT2 relay on ATR243-20... Configurable as command output or retransmission of setpoint or process. | Configurable: > 4-20mA, > 0...10Volt, > 0-20mA. Resolution 4000 points |

3.3 Software Features

| | |
|------------------------------|--|
| <i>Regulation algorithms</i> | ON-OFF with hysteresis. P, PI, PID, PD with proportional time |
| <i>Proportional band</i> | 0...9999°C or °F |
| <i>Integral time</i> | 0,0...999,9 sec (0 excluded) |
| <i>Derivative time</i> | 0,0...999,9 sec (0 excluded) |
| <i>Controller functions</i> | Manual or automatic Tuning, configurable alarms, protection of command and alarm setpoints, activation of functions via digital input, preset cycle with Start/Stop. |

4 Dimensions and Installation

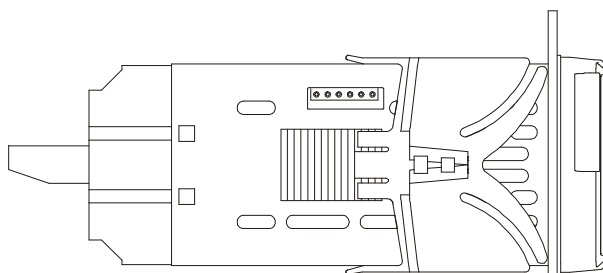
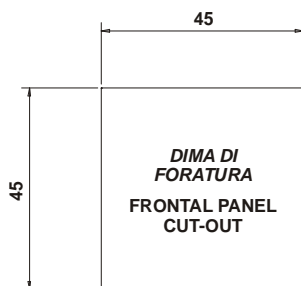
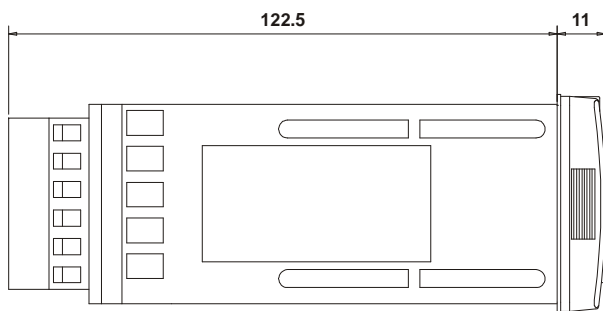
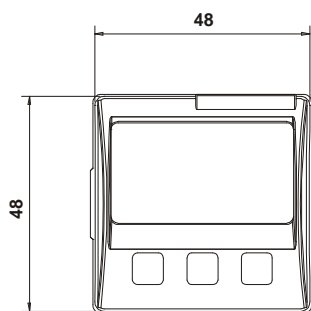

SPESSORE PANNELLO CONSIGLIATO
SUGGESTED THICKNESS
 2-8mm MAX 19mm

4.1 Panel Assembly

Method of panel assembly and fixing of anchorage hooks.

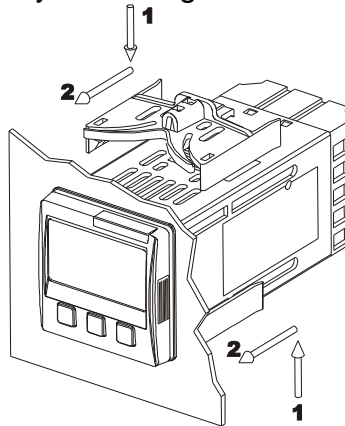

To dismantle, use a screwdriver and slightly force the fixing hooks to remove them from the fixing guide.

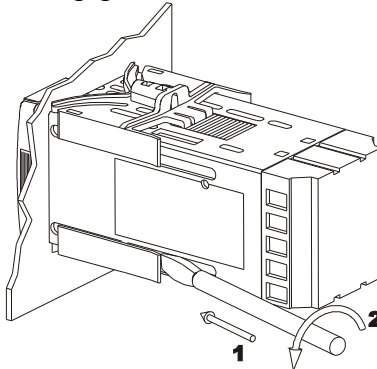

4.2 Electronics Removal

To remove the electronics, grip the front part using the two specific side ridges.

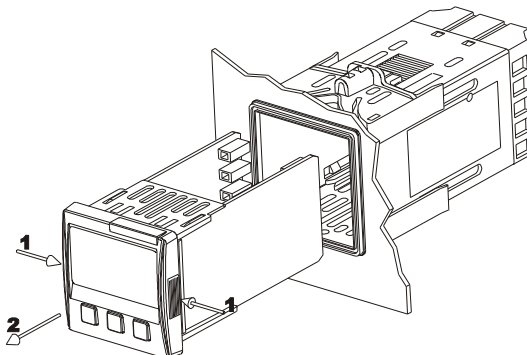

5 Electrical wirings



Although this controller was designed to resist noises in industrial environments, please notice following safety guidelines:

- Separate the feeder line from the power lines.
- Avoid placing near units with remote control switches, electromagnetic contactors, high powered motors and in all instances use specific filters.
- Avoid placing near power units, particularly if phase controlled.

5.1 Wiring diagram

The connections are reported below for the three models available.

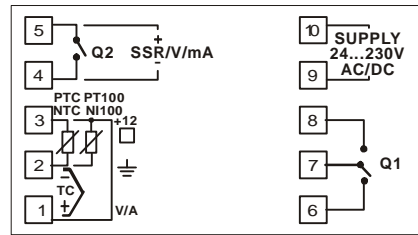
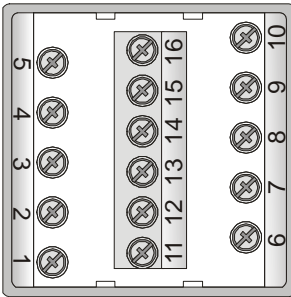

ATR243-20ABC

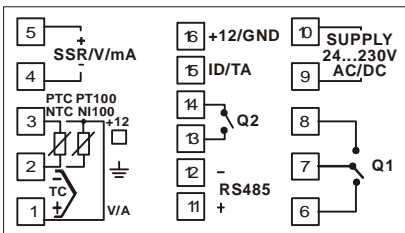

ATR243-21ABC-T

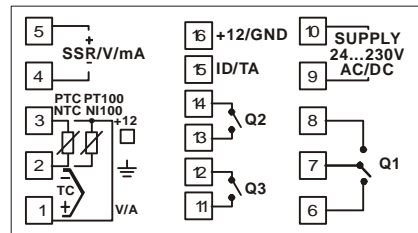

ATR243-31ABC

Power

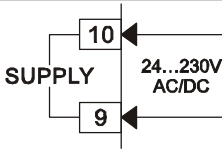

Switching power supply with extended range
24...230 Vac/dc $\pm 15\%$ 50/60Hz - 3VA.

AN1 Analogue Input

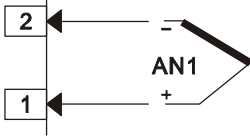

For thermocouples K, S, R, J.

- Comply with polarity
- For possible extensions, use a compensated wire and terminals suitable for the thermocouples used (compensated)

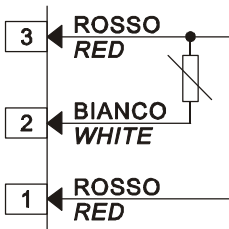

For thermoresistances PT100, NI100

- For the three-wire connection use wires with the same section
- For the two-wire connection short-circuit terminals 1 and 3
- Select internal jumper **JP3** as in the figure

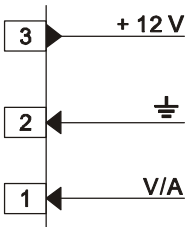
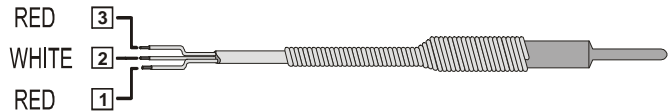
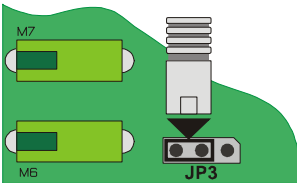

For linear signals V/mA

- Comply with polarity
- Select internal jumper **JP3** as in the figure

! If jumpers are not properly selected, 12Vdc are not available on terminal 3 to power the sensor.

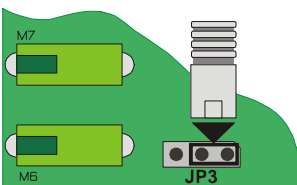

Examples of Connection for linear input

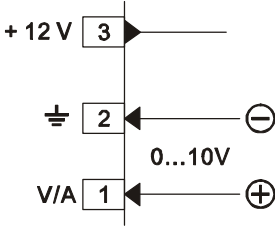

For signals 0...10V

Comply with polarity

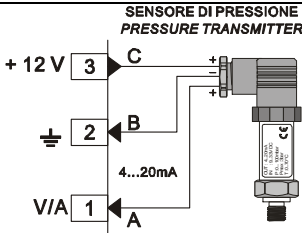

For signals 0/4...20mA with **three-wire sensor**

Comply with polarity

A=Sensor output

B=Sensor ground

C=Sensor power

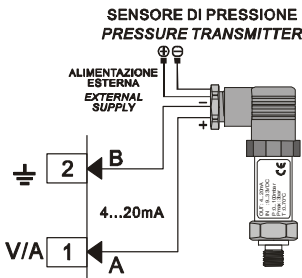

For signals 0/4...20mA with **external power of sensor**

Comply with polarity

A=Sensor output

B=Sensor ground

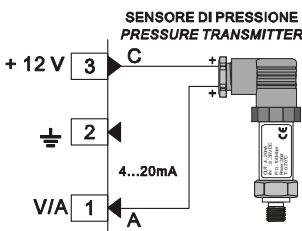

For signals 0/4...20mA with **two-wire sensor**

Comply with polarity

A=Sensor output

C=Sensor power supply

Serial input

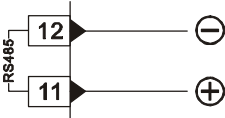

RS485 Modbus RTU communication

Relay Q1 Output

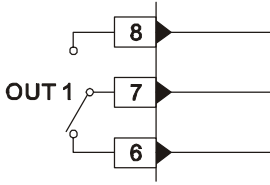

Capacity 5A/250V~ for resistive loads

Relay Q2 Output

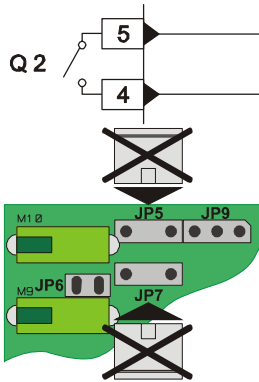

Capacity 5A/250V~ for resistive loads

For Q2 selected as a relay output, remove jumpers JP5 and JP7 as indicated in the figure (Manufacturer configuration).

! Connecting a load without removing the jumpers will permanently damage the controller

For models ATR243-21ABC-T and ATR243-31ABC output Q2 is on terminals 14 and 13.

Q2 output for SSR

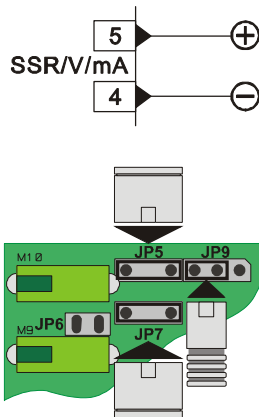

SSR command output 12V/30mA

! Insert JP5 and JP7 and select JP9 as in the figure to use the SSR output.

Q2 Output in mA or in Volt

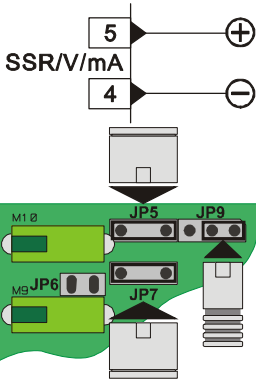

Linear output in **mA** configurable using parameters as command (Parameter `COU`) or retransmission of process-setpoint (Parameter `RETR.`)

⚠ Insert JP5 and JP7 and select JP9 as in figure to use the output in mA.

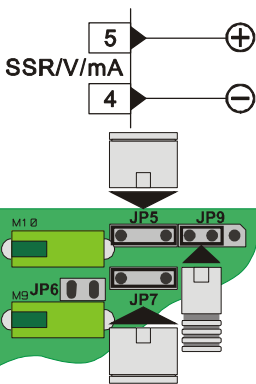

Linear output in **Volt** configurable using parameters as command (Parameter `COU`) or retransmission of process-setpoint (Parameter `RETR.`)

⚠ Insert JP5 and JP7 and select JP9 as in figure to use the linear output in Volt.

Q3 Relay Output on ATR243-31ABC

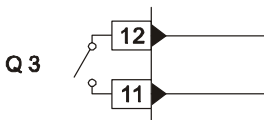

Capacity 5A/250V~ resistive loads

Amperometric Transformer Input on ATR243-21ABC-T and ATR243-31ABC

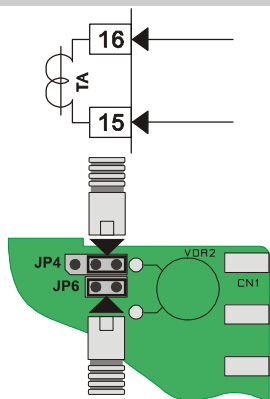

- Input 50mA for amperometric transformer
- Sampling time 80ms
- Configurable by parameters

! Insert JP4 and JP6 as in figure to select the amperometric transformer input.

Digital Input on ATR243-20ABC

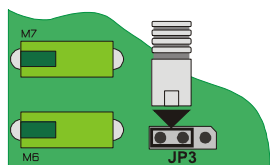

Digital input using parameter `DCI. ↓`.
The use of digital input in this version is possible only with TC sensors, 0...10V, 0/4...20mA and 0...40mV

! Select internal jumper JP3 as in figure.

Digital Input on ATR243-21ABC-T and ATR243-31ABC

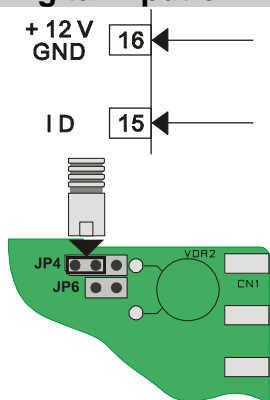

Digital input using parameter `DCI. ↓`

! Insert JP4 as in figure to select the digital input.

6 Display and Key Functions

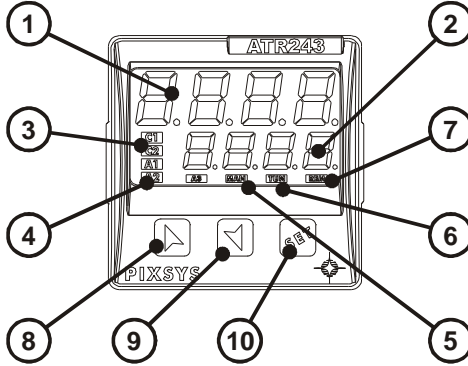







6.1 Numeric Indicators (Display)

| | | |
|---|--|---|
| 1 | | Normally displays the process. During the configuration phase, it displays the parameter being inserted. |
| 2 | | Normally displays the setpoint. During the configuration phase, it displays the parameter value being inserted. |

6.2 Meaning of Status Lights (Led)

| | | |
|---|--|--|
| 3 | | ON when the output command is on. C1 with relay/SSR/mA/Volt command or C1 (open) and C2 (close) for a motorised valve command. |
| 4 | | ON when the corresponding alarm is on. |
| 5 | | ON when the "Manual" function is on. |
| 6 | | ON when the controller is running an "Autotune" cycle. |
| 7 | | ON when the controller communicates via serial port. |





6.3 Keys

| | | |
|----|---|---|
| 8 |  | <ul style="list-style-type: none"> • Allows to increase the main setpoint. • During the configuration phase, allows to slide through parameters. Together with the  key it modifies them. • Pressed after the  key it allows to increase the alarm setpoint. |
| 9 |  | <ul style="list-style-type: none"> • Allows to decrease the main setpoint. • During the configuration phase, allows to slide through parameters. Together with the  key it modifies them. • Pressed after the  key it allows to decrease the alarm setpoint. |
| 10 |  | <ul style="list-style-type: none"> • Allows to display the alarm setpoint and runs the autotuning function. • Allows to vary the configuration parameters. |

7 Controller Functions

7.1 Modifying Main Setpoint and Alarm Setpoint Values

The setpoint value can be changed from the keyboard as follows:

| | Press | Effect | Operation |
|---|--|---------------------------------------|--|
| 1 |  or  | Value on display 2 changes | Increases or decreases the main setpoint |
| 2 |  | Visualize alarm setpoint on display 1 | |
| 3 |  or  | Value on display 2 changes | Increases or decreases the alarm set point value |



7.2 Auto-Tune

The Tuning procedure calculates the controller parameters and can be manual or automatic according to selection on parameter 57 (TUNE).

7.3 Manual Tuning

The manual procedure allows the user greater flexibility to decide when to update PID algorithm work parameters. The procedure can be activated in two ways.

- **By running Tuning from keyboard:**

Press the  key until display 1 shows the writing TUNE with display 2 showing OFF, press , display 2 shows ON. The TUN led switches on and the procedure begins.

- **By running Tuning from digital input:**



Select TUNE on parameter 61 DGE.

On first activation of digital input (commutation on front panel) the TUN led switches on and on second activation switches off.

7.4 Automatic Tuning

Automatic tuning activates when the controller is switched on or when the setpoint is modified to a value over 35%.

To avoid an overshoot, the threshold where the controller calculates the new PID parameters is determined by the setpoint value minus the "Set Deviation Tune" (see Parameter 58 SdTu).

To exit Tuning and leave the PID values unchanged, just press the  key until display 1 shows the writing TUNE with the display showing ON, press , display 2 shows OFF.

The TUN led switches off and the procedure finishes.

7.5 Soft Start

To reach the setpoint the controller can follow a gradient expressed in units (e.g. degree/hour).

Set the increase value in parameter 62 **GrAd** with the desired units/hour; only **on subsequent activation** the controller uses the soft start function.



Automatic/manual tuning cannot be enabled if the Soft start is active.

7.6 Automatic/Manual Regulation for % Output Control

This function allows you to select automatic functioning or manual command of the output percentage.

With parameter 60 **Auto**, you can select two methods.

1. **The first selection** **En** allows you to enable the  key with the writing **P.---** on display 1, while display two shows **Auto**.

Press the  key to show **MAN**; it is now possible, during the process display, to change the output percentage using the keys  and . To return to automatic mode, using the same procedure, select **Auto** on display 2: the **MAN** led switches off and functioning returns to automatic mode.

2. **The second selection** **EnSt** enables the same functioning, but with two important variants:
 - If there is a temporary lack of voltage or after switch-off, the manual functioning will be maintained as well as the previously set output percentage value.
 - If the sensor breaks during automatic functioning, the controller moves to manual mode while maintaining the output percentage command unchanged as generated by the PID immediately before breakage.

7.7 Pre-Programmed Cycle

The pre-programmed cycle function activates by setting `Prc4` or `Pc55` in parameter 59 `OPNa`.

First option `Prc4` : the controller reaches setpoint1 basing on the gradient set in parameter 62 `GrAd`, then it reaches maximum power up to setpoint2. When the process reaches maximum power, this setpoint is maintained for the time set in parameter 63 `PAE`. On expiry, the command output is disabled and the controller displays `Stop`.

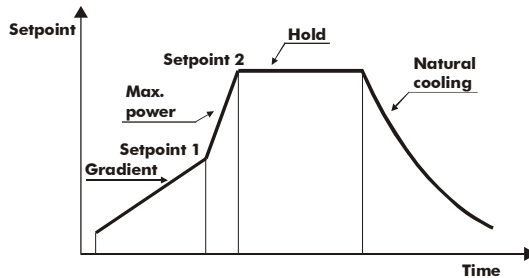

The cycle starts at each activation of the controller, or via digital input if it is enabled for this type of functioning (see parameter 61 `DOE`).

Second option `Pc55` : start-up is decided only on activation of the digital input, according to the setting of parameter 61 `DOE`. On start-up, the controller reaches setpoint 1 basing on the gradient set in parameter 62 `GrAd`. When the process reaches this gradient, it is maintained for the time set in parameter 63 `PAE`. On expiry, the command output is disabled and the controller displays `Stop`.

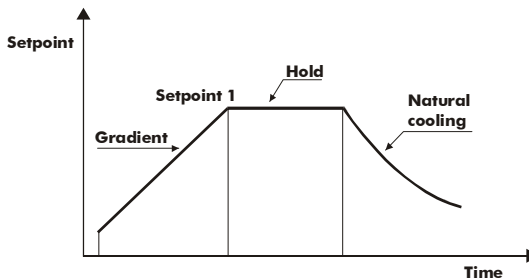

7.8 Memory Card



Parameters and setpoint values can be duplicated from one controller to another using the Memory card.

There are two methods:

- With the controller connected to the power supply

Insert the memory card **when the controller is off**.

On activation display 1 shows **MEMO** and display 2 shows **----**
(Only if the correct values are saved in the memory card). By

pressing the  key display 2 shows **LOAD**, then confirm using the  key. The controller loads the new data and starts again.

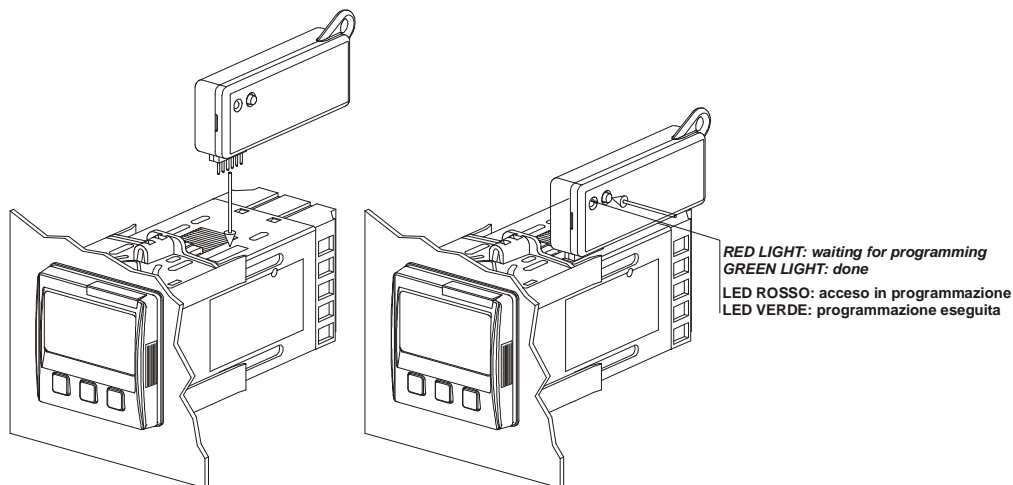

- With the controller not connected to power supply.

The memory card is equipped with an internal battery with an autonomy of about 1000 uses.

Insert the memory card and press the programming buttons.

When writing the parameters, the led turns red and on completing the procedure it changes to green. It is possible to repeat the procedure without any particular attention.

Updating Memory Card

To *update* the memory card values, follow the procedure described in the first method, setting display 2 to so as not to load the parameters on controller².

Enter configuration and **change at least one parameter**. Exit configuration. Changes are saved automatically.

8 LATCH ON Functions

For use with input (potentiometer 6K) and (potentiometer 150K) and with linear input (0...10V, 0...40mV, 0/4...20mA), you can associate start value of the scale (parameter 6) to the minimum position of the sensor and value of the scale end (parameter 7) to the maximum position of the sensor (parameter 8 configured as).









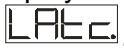
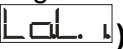

It is also possible to fix the point in which the controller will display 0 (however keeping the scale range between and) using the “virtual zero” option by setting or in parameter 8 . If you set the virtual zero will reset after each activation of the tool; if you set the virtual zero remains fixed once tuned.

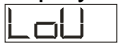
To use the LATCH ON function configure as you wish the parameter ³.

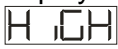
² If on activation the controller does not display it means no data have been saved on the memory card, but it is possible to update values.

³ The tuning procedure starts by exiting the configuration after changing the parameter.

For the calibration procedure refer to the following table:

| | Press | Effect | Operation |
|---|---|--|--|
| 1 |  | Exit parameters configuration. Display 2 shows the writing  . | Position the sensor on the minimum functioning value (associated with ) |
| 2 |  | Set the value to minimum. The display shows  | Position the sensor on the maximum functioning position (associated with ) |
| 3 |  | Set the value to maximum. The display shows  | To exit the standard procedure press  . For “virtual zero” settings position the sensor on the zero point. |
| 4 |  | Set the virtual zero value. The display shows  . N.B.: for selection of  the procedure in point 4 should be followed on each re-activation. | To exit the procedure press  . |

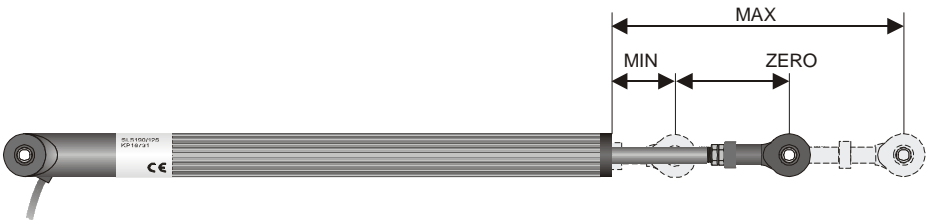

8.1 Loop Break Alarm On Amperometric Transformer



This function allows to measure load current and to manage an alarm during malfunctioning with power in short circuit or always off. The amperometric transformer connected to terminals 15 and 16 must be 50mA (sampling time 80ms).

- Set scale end value of the amperometric transformer in Amperes on parameter 47
- Set the intervention threshold of the Loop break alarm in Amperes on parameter 48
- Set the intervention delay time of the Loop break alarm on parameter 49
- You can associate the alarm with a relay by setting the parameter , or as

If a remote control switch or SSR remains closed, the controller signals the fault by showing on display 2 (alternatively with a command setpoint).

If instead the power stage remains open, or the load current is lower than the value set on , the controller shows on display.

You can display the current absorbed during the closure phase of the power stage.

| | Press | Effect | Operation |
|---|---|---|---|
| 1 |  | This key enables to scroll on display 2 the output percentage, auto/man selection, setpoint and alarms. | Press  until the writing <input type="text" value="ANEA"/> appears on display 1 and display 2 shows the current in amperes (<input type="text" value="EA"/> > 0). The value is also maintained when no current circulates on the load. |

8.2 Digital Input Functions

Digital input is programmable for several functions which are useful to simplify controller operability. Select the desired function on parameter 62 `dCt.`.

1. Hold function (enabled by setting `Lcna` or `Lcnc`) allows to lock the reading of sensors when the digital input is active (useful for wide ranging oscillation on less significant values). During the lock phase, display 2 flashes and shows `Loct`.
2. Enables/disables the autotuning function from digital input if the parameter `tuneE` is set on `NA.`.
3. Enable regulation with `rana` or `ranc`.
4. Switch from automatic to manual functioning if `AWNA` is set on `En.` or `EnSt.`.
5. Start of pre-programmed cycle (see paragraph 7.7) with `SESt.`.
6. Change setpoint function.
This function is useful where there are 2 to 4 working thresholds required during system functioning without having to press the arrow keys.

To enable the function use the parameter `oPna`, by selecting the number of setpoints desired (no. thresholds switch). They can be switched during functioning by pressing the  key.

N.B.:

The digital input functions **are not** available with sensors PT100 and NI100 on model ATR243-20ABC.

8.3 Dual Action Heating-Cooling

ATR243 is also suitable also for systems requiring a combined heating-cooling action.

The command output must be configured as Heating PID ($\text{ACTE} = \text{HEAT}$ and with a PB greater than 0), and one of the alarms (AL. 1 , AL. 2 or AL. 3) must be configured as COOL . The command output must be connected to the actuator responsible for heat, while the alarm will control cooling action.

The parameters to configure for the Heating PID are:

$\text{ACTE} = \text{HEAT}$ Command output type (Heating)

PB : Heating proportional band

Ti : Integral time of heating and cooling

Td : Derivative time of heating and cooling

tc : Heating time cycle

The parameters to configure for the Cooling PID are the following (example: action associated to alarm1):

$\text{AL. 1} = \text{COOL}$ Alarm1 selection (cooling)

PbN : Proportional band multiplier

owdb : Overlapping/Dead band

cotc : Cooling time cycle

The parameter PbN (that ranges from 1.00 to 5.00) determines the proportional band of cooling basing on the formula:

Cooling proportional band = $\text{PB} * \text{PbN}$

This gives a proportional band for cooling which will be the same as heating band if $\text{PbN} = 1.00$, or 5 times greater if $\text{PbN} = 5.00$.

The **integral time and derivative time** are the same for both actions.

The parameter owdb determines the percentage overlapping between the two actions. For systems in which the heating output and cooling output must never be simultaneously active a dead band ($\text{owdb} \leq 0$) must be configured, and vice versa you can configure an overlapping ($\text{owdb} > 0$).

The following figure shows an example of dual action PID (heating-cooling) with $E_i = 0$ and $E_d = 0$.

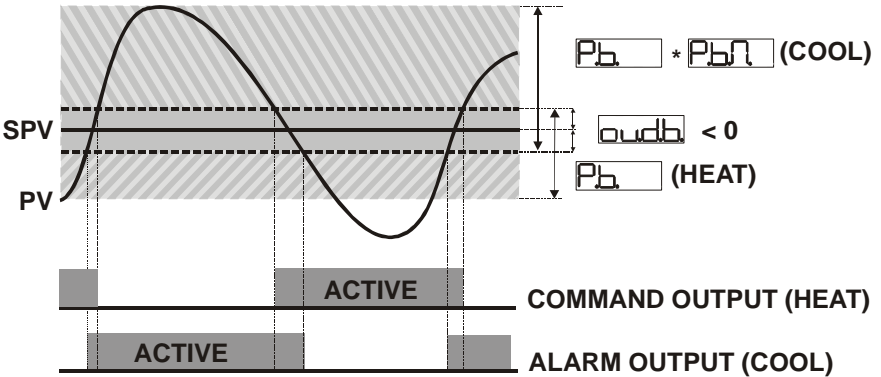
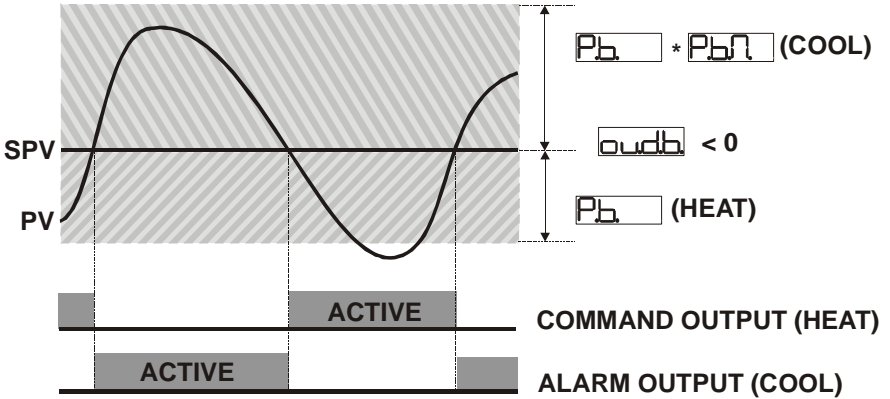
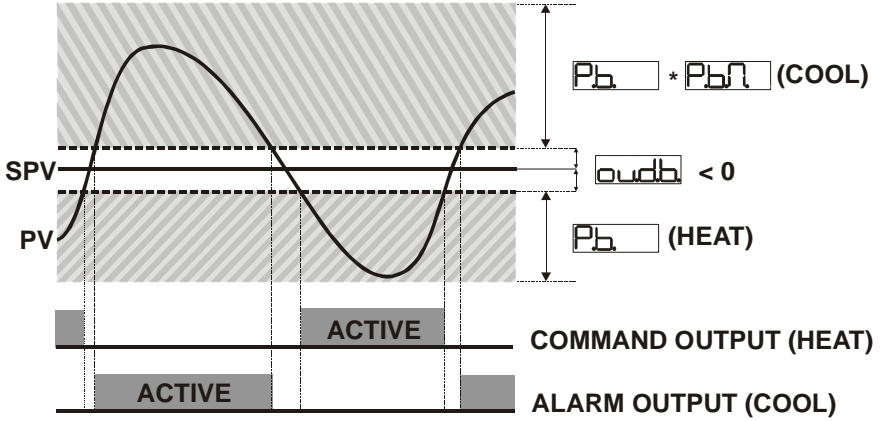

The parameter `catc` has the same meaning as the heating time cycle `tc`.

The parameter `coof` (cooling fluid) pre-selects the proportional band multiplier `Pbn` and the cooling PID time cycle `catc` basing on the type of cooling fluid:

| <code>coof</code> | Cooling fluid type | <code>Pbn</code> | <code>catc</code> |
|-------------------|--------------------|------------------|-------------------|
| Air | Air | 1.00 | 10 |
| oil | Oil | 1.25 | 4 |
| H ₂ O | Water | 2.50 | 2 |

Once selected, the parameter `coof`, the parameters `Pbn`, `audb` and `catc` can however be changed.

9 Serial Communication

ATR243-21ABC-T, equipped with RS485, can receive and broadcast data via serial communication using MODBUS RTU protocol. The device can only be configured as a Slave. This function enables the control of multiple controllers connected to a supervisory system (SCADA).

Each controller responds to a master query only if the query contains the same address as that in the parameter `SLAd`. The addresses permitted range from 1 to 254 and there must not be controllers with the same address on the same line.

Address 255 can be used by the master to communicate with all the connected equipment (broadcast mode), while with 0 all the devices receive the command, but no response is expected.

ATR243 can introduce a delay (in milliseconds) in the response to the master request. This delay must be set on parameter 72 `SEDE`.

Each parameter change is saved by the controller in the EEPROM memory (100000 writing cycles), while the setpoints are saved with a delay of ten seconds after the last change.

NB: Changes made to words that are different from those reported in the following table can lead to malfunction.

Modbus RTU protocol features

| | |
|----------------------------|--|
| <i>Baud-rate</i> | Can be selected on parameter 70 <input type="text" value="bdrE"/> |
| | <input type="text" value="48F"/> 4800bit/sec |
| | <input type="text" value="96F"/> 9600bit/sec |
| | <input type="text" value="192F"/> 19200bit/sec |
| | <input type="text" value="288F"/> 28800bit/sec |
| | <input type="text" value="384F"/> 38400bit/sec |
| | <input type="text" value="576F"/> 57600bit/sec |
| <i>Format</i> | 8, N, 1 (8bit, no parity, 1 stop) |
| <i>Supported functions</i> | WORD READING (max 20 word) (0x03, 0x04) SINGLE WORD WRITING (0x06) MULTIPLE WORDS WRITING (max 20 word) (0x10) |

The list below includes all the available addresses, where:

RO = Read Only

R/W = Read/Write



WO = Write Only

| Modbus address | Description | Read Write | Reset value |
|----------------|---|------------|-------------|
| 0 | Device type | RO | EEPROM |
| 1 | Software version | RO | EEPROM |
| 5 | Slave Address | R/W | EEPROM |
| 6 | Boot version | RO | EEPROM |
| 50 | Automatic addressing | WO | - |
| 51 | System code comparison | WO | - |
| 1000 | Process (with tenths of degree for temperature sensors; digits for linear sensors) | RO | ? |
| 1001 | Setpoint1 | R/W | EEPROM |
| 1002 | Setpoint2 | R/W | EEPROM |
| 1003 | Setpoint3 | R/W | EEPROM |
| 1004 | Setpoint4 | R/W | EEPROM |
| 1005 | Alarm1 | R/W | EEPROM |
| 1006 | Alarm2 | R/W | EEPROM |
| 1007 | Alarm3 | R/W | EEPROM |
| 1008 | Setpoint gradient | RO | EEPROM |
| 1009 | Relay status (0=off, 1=on) Bit 0 = Q1 relay Bit 1 = Q2 relay Bit 2 = reserved Bit 3 = SSR | RO | 0 |
| 1010 | Heating output percentage (0-10000) | RO | 0 |
| 1011 | Cooling output percentage (0-10000) | RO | 0 |
| 1012 | Alarms status (0=none, 1=active) Bit0 = Alarm 1 Bit1 = Alarm 2 | RO | 0 |
| 1013 | Manual reset: write 0 to reset all the alarms. In reading (0=not resettable, 1=resettable): Bit0 = Alarm 1 Bit1 = Alarm 2 | WO | 0 |
| 1014 | Error flags Bit0 = Eeprom writing error Bit1 = Eeprom reading error Bit2 = Cold junction error Bit3 = Process error (sensor) Bit4 = Generic error Bit5 = Hardware error Bit6 = L.B.A.O. error Bit7 = L.B.A.C. error | RO | 0 |
| 1015 | Cold junction temperature (tenths of degree) | RO | ? |

| | | | |
|------|---|-----|--------|
| 1016 | Start/Stop 0=controller in STOP 1=controller in START | R/W | 0 |
| 1017 | Lock conversion ON/OFF 0=Lock conversion off 1=Lock conversion on | R/W | 0 |
| 1018 | Tuning ON/OFF 0=Tuning off 1=Tuning on | R/W | 0 |
| 1019 | Automatic/manual selection 0=automatic 1=manual | R/W | 0 |
| 1020 | TA Current ON (amperes to tenths) | RO | ? |
| 1021 | TA Current OFF (ampere to tenths) | RO | ? |
| 1022 | OFF LINE ¹ time (milliseconds) | R/W | 0 |
| 1023 | Instant Current (Ampere) | RO | 0 |
| 2001 | Parameter 1 | R/W | EEPROM |
| 2002 | Parameter 2 | R/W | EEPROM |
| ... | ... | ... | ... |
| 2072 | Parameter 72 | R/W | EEPROM |
| 3000 | Disabling serial control of machine ² | WO | 0 |
| 3001 | First word display1 (ASCII) | R/W | 0 |
| 3002 | Second word display1 (ASCII) | R/W | 0 |
| 3003 | Third word display1 (ASCII) | R/W | 0 |
| 3004 | Fourth word display1 (ASCII) | R/W | 0 |
| 3005 | Fifth word display1 (ASCII) | R/W | 0 |
| 3006 | Sixth word display1 (ASCII) | R/W | 0 |
| 3007 | Seventh word display1 (ASCII) | R/W | 0 |
| 3008 | Eighth word display1 (ASCII) | R/W | 0 |
| 3009 | First word display2 (ASCII) | R/W | 0 |
| 3010 | Second word display2 (ASCII) | R/W | 0 |
| 3011 | Third word display2 (ASCII) | R/W | 0 |
| 3012 | Fourth word display2 (ASCII) | R/W | 0 |
| 3013 | Fifth word display2 (ASCII) | R/W | 0 |
| 3014 | Sixth word display2 (ASCII) | R/W | 0 |
| 3015 | Seventh display2 (ASCII) | R/W | 0 |
| 3016 | Eighth word display2 (ASCII) | R/W | 0 |

¹ If value is 0, the control is disabled. If different from 0, it is the max. time which can elapse between two pollings before the controller goes off-line.
If it goes off-line, the controller returns to Stop mode, the control output is disabled but the alarms are active.

















² By writing 1 on this word, the effects of the writing are cancelled on all the Modbus addresses from 3001 to 3022. Control therefore returns to the controller.

| | | | |
|------|---|-----|---|
| 3017 | Word LED Bit 0 = LED C1 Bit 1 = LED C2 Bit 2 = LED A1 Bit 3 = LED A2 Bit 4 = LED A3 Bit 5 = LED MAN Bit 6 = LED TUN Bit 7 = LED REM | R/W | 0 |
| 3018 | Word keys (write 1 to command keys) Bit 0 =  Bit 1 =  Bit 2 =  | R/W | 0 |
| 3019 | Word serial relay Bit 0 = Q1 relay Bit 1 = Q2 relay | R/W | 0 |
| 3020 | Word SSR serial (0=off, 1=on) | R/W | 0 |
| 3021 | Word output 0...10V serial (0...10000) | R/W | 0 |
| 3022 | Word output 4...20mA serial (0...10000) | R/W | 0 |

10 Configuration

10.1 Modify Configuration Parameter

For configuration parameters see paragraph 11.

| | Press | Effect | Operation |
|---|--|--|---|
| 1 |  for 3 seconds. | Display 1 shows  with the 1st digit flashing, while display 2 shows  . | |
| 2 |  or  | Change the flashing digit and move to the next one using the  key. | Enter password  |
| 3 |  to confirm | Display 1 shows the first parameter and display 2 shows the value. | |
| 4 |  or  | Slide up/down through parameters | |
| 5 |  +  or  | Increase or decrease the value displayed by pressing firstly  and then an arrow key. | Enter the new data which will be saved on releasing the keys. To change another parameter return to point 4. |
| 6 |  +  Simultaneou sly | End of configuration parameter change. The controller exits from programming. | |

11 Table of Configuration Parameters























The following table includes all parameters. Some of them will not be visible on the models which are not provided with relevant hardware features.

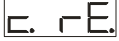

| no. | Display | Parameter description | Entering range |
|-----|---|----------------------------|--|
| 1 | <div style="border: 1px solid black; padding: 2px; display: inline-block; margin-bottom: 5px;">c.o1</div> Command Output | Select command output type | <div style="border: 1px solid black; padding: 2px; display: inline-block; margin-bottom: 5px;">c. o 1</div> Default (necessary to use retransmission function) <div style="border: 1px solid black; padding: 2px; display: inline-block; margin-bottom: 5px;">c. o2</div> <div style="border: 1px solid black; padding: 2px; display: inline-block; margin-bottom: 5px;">c.SSr</div> <div style="border: 1px solid black; padding: 2px; display: inline-block; margin-bottom: 5px;">c.uAL</div> <div style="border: 1px solid black; padding: 2px; display: inline-block; margin-bottom: 5px;">c.420</div> <div style="border: 1px solid black; padding: 2px; display: inline-block; margin-bottom: 5px;">c.O20</div> <div style="border: 1px solid black; padding: 2px; display: inline-block;">c.Q 10</div> |

| ATR243-20ABC | | | |
|---|-------------------------|----------------|----------------|
| | <i>COMMAND</i> | <i>ALARM 1</i> | |
| <div style="border: 1px solid black; padding: 2px; display: inline-block;">c. o 1</div> | Q1 | Q2 | |
| <div style="border: 1px solid black; padding: 2px; display: inline-block;">c. o2</div> | Q2 | Q1 | |
| <div style="border: 1px solid black; padding: 2px; display: inline-block;">c.SSr</div> | SSR | Q1 | |
| <div style="border: 1px solid black; padding: 2px; display: inline-block;">c.uAL</div> | Q1(opens) Q2(closes) | - | |
| <div style="border: 1px solid black; padding: 2px; display: inline-block;">c.420</div> | SSR | Q1 | |
| <div style="border: 1px solid black; padding: 2px; display: inline-block;">c.O20</div> | SSR | Q1 | |
| <div style="border: 1px solid black; padding: 2px; display: inline-block;">c.Q 10</div> | SSR | Q1 | |
| ATR243-21ABC-T | | | |
| | <i>COMMAND</i> | <i>ALARM 1</i> | <i>ALARM 2</i> |
| <div style="border: 1px solid black; padding: 2px; display: inline-block;">c. o 1</div> | Q1 | Q2 | SSR |
| <div style="border: 1px solid black; padding: 2px; display: inline-block;">c. o2</div> | Q2 | Q1 | SSR |
| <div style="border: 1px solid black; padding: 2px; display: inline-block;">c.SSr</div> | SSR | Q1 | Q2 |
| <div style="border: 1px solid black; padding: 2px; display: inline-block;">c.uAL</div> | Q1(opens) Q2(closes) | SSR | - |
| <div style="border: 1px solid black; padding: 2px; display: inline-block;">c.420</div> | SSR | Q1 | Q2 |
| <div style="border: 1px solid black; padding: 2px; display: inline-block;">c.O20</div> | SSR | Q1 | Q2 |
| <div style="border: 1px solid black; padding: 2px; display: inline-block;">c.Q 10</div> | SSR | Q1 | Q2 |

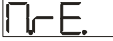
| ATR243-31ABC | | | | |
|-------------------------------------|-------------------------|---------|---------|---------|
| | COMMAND | ALARM 1 | ALARM 2 | ALARM 3 |
| <input type="text" value="c. 01"/> | Q1 | Q2 | Q3 | SSR |
| <input type="text" value="c. 02"/> | Q2 | Q1 | Q3 | SSR |
| <input type="text" value="c55r"/> | SSR | Q1 | Q2 | Q3 |
| <input type="text" value="cJAL"/> | Q2(opens) Q3(closes) | Q1 | SSR | - |
| <input type="text" value="c.420"/> | SSR | Q1 | Q2 | Q3 |
| <input type="text" value="c.020"/> | SSR | Q1 | Q2 | Q3 |
| <input type="text" value="c.0.10"/> | SSR | Q1 | Q2 | Q3 |

| | | | |
|---|--|--|--|
| 2 | <input type="text" value="SEn"/> Sensor | Analog input configuration | <input type="text" value="tc. F"/> Tc-K -260...1360°C (Default setting) |
| | | | <input type="text" value="tc. S"/> Tc-S -40...1760°C |
| | | | <input type="text" value="tc. r"/> Tc-R -40...1760°C |
| | | | <input type="text" value="tc. J"/> Tc-J -200...1200°C |
| | | | <input type="text" value="Pt"/> PT100 -100...600°C |
| | | | <input type="text" value="Pt 1"/> PT100 -100...140°C |
| | | | <input type="text" value="ni 1"/> NI100 -60...180°C |
| | | | <input type="text" value="ntc"/> NTC10K -40...125°C |
| | | | <input type="text" value="Ptc"/> PTC1K -50...150°C |
| | | | <input type="text" value="Pt5"/> PT500 -100...600°C |
| | | | <input type="text" value="Pt 1F"/> PT1000 -100...600°C |
| | | | <input type="text" value="0.10"/> 0...10Volt |
| | | | <input type="text" value="020"/> 0...20mA |
| | | | <input type="text" value="420"/> 4...20mA |
| | | | <input type="text" value="0.40"/> 0...40mVolt |
| | | | <input type="text" value="Pot. 1"/> Potentiometer max 6Kohm |
| | | | <input type="text" value="Pot.2"/> Potentiometer max 150Kohm |
| | | Only ATR243-21/31ABC | <input type="text" value="tA"/> 50mA secondary amperometric transformer |
| | <input type="text" value="dP."/> | Select number of displayed decimal points | <input type="text" value="0"/> Default |

| | | | |
|----|---|--|---|
| 3 | Decimal Point | |    |
| 4 |  Lower Limit Setpoint | Lower limit setpoint | -999...+9999 digit* (degrees if temperature) Default: 0. |
| 5 |  Upper Limit Setpoint | Upper limit setpoint | -999...+9999 digit* (degrees if temperature) Default: 1750. |
| 6 |  Lower Linear Input | Lower range limit An1 only for linear input | -999...+9999 digit* Default: 0. |
| 7 |  Upper Linear Input | Upper range limit An1 only for linear input | -999...+9999 digit* Default: 1000. |
| 8 |  Latch On Function | Automatic setting of limits for Linear input |  (Disabled) Default  (Standard)  (Virtual Zero Stored)  (Virtual Zero Initialized) |
| 9 |  Offset Calibration | Offset calibration Number added to displayed value of process (normally corrects the room temperature value) | -999...+1000 digit* for linear sensors and potentiometers. -200.0...+100.0 tenths for temperature sensors. Default: 0.0. |
| 10 |  Gain Calibration | Gain calibration Value multiplied with process value to perform calibration on working point | -10.0%...+10.0% Default: 0.0. |
| 11 |  Action type | Regulation type |  : Heating (N.O.) Default  : Cooling (N.C.)  : HEat Off Over Setpoint |
| 12 |  Command Reset | Type of reset for state of command contact (always automatic in PID functioning) |  (Automatic Reset) Default  (Manual Reset)  (Manual Reset Stored) |

* The display of the decimal point depends on the setting of parameter  and the parameter .

















| | | | |
|----|---|---|---|
| 13 | <input type="text" value="E. SE"/> Command State Error | State of contact for command output in case of error | <input type="text" value="CO"/> Default <input type="text" value="CC"/> |
| 14 | <input type="text" value="E. LD"/> Command Led | State of the OUT1 led corresponding to the relevant contact | <input type="text" value="CO"/> Default <input type="text" value="CC"/> |
| 15 | <input type="text" value="E. HY"/> Command Hysteresis | Hysteresis in ON/OFF or dead band in P.I.D. | -999...+999 digits* (tenths of degree if temperature) Default: 0.0. |
| 16 | <input type="text" value="E. dE"/> Command Delay | Command delay (only in ON/OFF functioning). (In case of servo valve it also functions in PID and represents the delay between the opening and closure of the two contacts) | -180...+180 seconds (tenths of second in case of servo valve). Negative: delay in switching off phase. Positive: delay in activation phase. Default: 0. |
| 17 | <input type="text" value="E. SP"/> Command Setpoint Protection | Allows or not to change the command setpoint value | <input type="text" value="FrEE"/> Default <input type="text" value="LoCk"/> |
| 18 | <input type="text" value="Pb"/> Proportional Band | Proportional band Process inertia in units (E.g.: if temperature is in °C) | 0 on/off if <input type="text" value="E. I"/> equal to 0 . Default 1-9999 digit* (degrees if temperature) |
| 19 | <input type="text" value="E. I"/> Integral Time | Integral time. Process inertia in seconds | 0.0-999.9 seconds (0 integral disabled) Default: 0. |
| 20 | <input type="text" value="Ed"/> Derivative Time | Derivative time. Normally ¼ the integral time | 0.0-999.9 seconds (0 derivative disabled) Default: 0. |
| 21 | <input type="text" value="E.C"/> Cycle Time | Cycle time (for PID on remote control switch 10/15sec, for PID on SSR 1 sec) or servo time (value declared by servo-motor manufacturer) | 1-300 seconds Default: 10. |
| 22 | <input type="text" value="oPaL"/> Output Power Limit | Limit of output power % | 10-100 % Default: 100. |

* The display of the decimal point depends on the setting of parameter

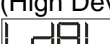
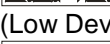
and parameter

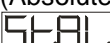
| | | | |
|----|---|--|--|
| 23 | <input type="text" value="AL. 1"/> Alarm 1 | Alarm 1 selection. Intervention of the alarm is associated with AL1 Only ATR243-21/31ABC | <input type="text" value="d.5"/> (Disabled) Default <input type="text" value="A.AL"/> (Absolute Alarm) <input type="text" value="b.AL"/> (Band Alarm) <input type="text" value="HdAL"/> (High Deviation Alarm) <input type="text" value="LdAL"/> (Low Deviation Alarm) <input type="text" value="AcAL"/> (Absolute Command setpoint Alarm) <input type="text" value="StAL"/> (Start Alarm) Active in Run <input type="text" value="COOL"/> (Cooling) <input type="text" value="LBA"/> (Loop Break Alarm) |
| 24 | <input type="text" value="A.1Sa"/> Alarm 1 State Output | Alarm 1 output contact and intervention type | <input type="text" value="no S"/> (n.o. start) Default Normally open, active at start <input type="text" value="nc. S"/> (n.c. start) Normally closed, active at start <input type="text" value="no E."/> (n.o. threshold) Normally open, active on reaching alarm ⁴ <input type="text" value="nc. E."/> (n.c. threshold) Normally closed on reaching alarm ⁴ |
| 25 | <input type="text" value="A.r.E."/> Alarm 1 Reset | Type of Reset for contact of alarm 1 | <input type="text" value="A.r.E."/> (Automatic Reset) Default <input type="text" value="M.r.E."/> (Manual Reset) <input type="text" value="M.r.E.S."/> (Manual Reset Stored) |
| 26 | <input type="text" value="A.1SE."/> Alarm 1 State Error | State of contact for alarm 1 output in case of error | <input type="text" value="CO"/> Default <input type="text" value="CC"/> |
| 27 | <input type="text" value="A.1Ld"/> Alarm 1 Led | State of the OUT2 led corresponding to the relative contact | <input type="text" value="CO"/> <input type="text" value="CC"/> Default |
| 28 | <input type="text" value="A.1HY"/> Alarm 1 Hysteresis) | Alarm 1 hysteresis | -999...+999 digit* (tenths of degree if temperature). Default: 0. |

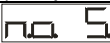
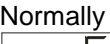
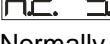
⁴ On activation, the output is inhibited if the controller is in alarm mode. Activates only if alarm condition reappears, after that it was restored.

| | | | |
|----|--|--|--|
| 29 |  Alarm 1 Delay | Alarm 1 delay | -180...+180 Seconds Negative: delay in alarm output phase. Positive: delay in alarm entry phase. Default: 0. |
| 30 |  Alarm 1 Setpoint Protection | Alarm 1 set protection. Does not allow user to modify setpoint |  Default   |
| 31 |  Alarm 2 | Alarm 2 selection. Alarm intervention is associated with AL2 |  (Disabled) Default  (Absolute Alarm)  (Band Alarm)  (High Deviation Alarm)  (Low Deviation Alarm)  (Absolute Command setpoint Alarm)  (Start Alarm)  (Cooling)  (Loop Break Alarm) |
| 32 |  Alarm 2 State Output | Alarm 2 output contact and intervention type |  (n.o. start) Default Normally open, active at start  (n.c. start) Normally closed, active at start  (n.o. threshold) Normally open, active on reaching alarm ⁵  (n.c. threshold) Normally closed, active on reaching alarm ⁵ |

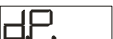
* The display of the decimal point depends on the setting of parameter  and parameter .

⁵ On activation, the output is inhibited if the controller is in alarm mode. It activates only if alarm condition reappears after that it was restored.

| | | | |
|----|---|--|--|
| 33 | A2rE. Alarm 2 Reset | Type of Reset for contact of alarm 2 | A-rE. (Automatic Reset) Default r-rE. (Manual Reset) r-rES. (Manual Reset Stored) |
| 34 | A2SE. Alarm 2 State Error | State of contact for alarm 2 output in case of error | CO Default CC. |
| 35 | A2Ld. Alarm 2 Led | State of OUT2 led corresponding to relative contact | CO CC. Default |
| 36 | A2H4. Alarm 2 Hysteresis | Alarm 2 hysteresis | -999...+999 digit* (tenths of degree if temperature). Default: 0. |
| 37 | A2DE. Alarm 2 Delay | Alarm 2 delay | -180...+180 Seconds Negative: delay in alarm output phase. Positive: delay in alarm entry phase. Default: 0. |
| 38 | A2SP. Alarm 2 Setpoint Protection | Alarm 2 set protection. Does not allow operator to change value of setpoint | FrEE Default Loct HiDE |
| 39 | AL. 3 Alarm 3 | Alarm 3 selection. Alarm intervention is associated with AL3 | d i s (Disabled) Default A. AL. (Absolute Alarm) b. AL. (Band Alarm) HdAL. (High Deviation Alarm) LdAL. (Low Deviation Alarm) AcAL. (Absolute Command setpoint Alarm) SEAL. (Start Alarm) COOL (Cooling) |

















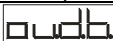





* The display of the decimal point depends on the setting of parameter **SEn.** and parameter **dP.**



| | | | |
|-----------|--|---|--|
| | | | LBa (Loop Break Alarm) |
| 40 | A35a Alarm 3 State Output | Alarm 3 output contact and intervention type | no S (n.o. start) Default Normally open, active at start nc S (n.c. start) Normally closed, active at start no E (n.o. threshold) Normally open, active on reaching alarm ⁶ nc E (n.c. threshold) Normally closed, active on reaching alarm ⁶ |
| 41 | A3rE Alarm 3 Reset | Type of Reset for contact of alarm 3 | A-rE (Automatic Reset) Default Man-rE (Manual Reset) Man-rES (Manual Reset Stored) |
| 42 | A35E Alarm 3 State Error | State of contact for alarm 3 output in case of error | CO Default CC |
| 43 | A3Ld Alarm 3 Led | Defines the state of OUT3 led corresponding to the relative contact | CO CC Default |
| 44 | A3HY Alarm 3 Hysteresis | Alarm 3 hysteresis | -999...+999 digit* (tenths of degree if temperature). Default: 0. |
| 45 | A3dE Alarm 3 Delay | Alarm 3 delay | -180...+180 Seconds Negative: delay in alarm output phase. Positive: delay in alarm entry phase. Default: 0. |
| 46 | A3SP Alarm 3 Setpoint Protection | Alarm 3 set protection. Does not allow the operator to change the value of setpoint | FrEE Default Loct H idE |
| 47 | EA | Activation and scale of amperometric | 0 Disabled 1-200 Ampere |





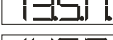











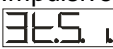

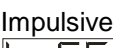
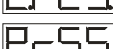

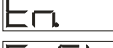

⁶ On activation, the output is inhibited if the controller is in alarm mode. It activates only if alarm condition reappears after that it was restored.

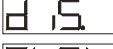

* The display of the decimal point depends on the setting of parameter **SEn**

























and parameter **dP.**

| | | | |
|----|---|---|---|
| | Amperometric Transformer | transformer | Default: 0. |
| 48 |  Loop Break Alarm Threshold | Intervention threshold of Loop break alarm | 0.0-200.0 Ampere Default: 50.0. |
| 49 |  (Loop Break Alarm Delay) | Delay time for Loop break alarm intervention | 00.00-60.00 mm.ss Default: 01.00. |
| 50 |  Cooling Fluid | Type of cooling fluid |  Default   |
| 51 |  Proportional Band Multiplier | Proportional band multiplier | 1.00-5.00 Default: 1.00. |
| 52 |  (Overlap/Dead Band) | Overlapping/Dead band | -20.0-50.0% Default: 0. |
| 53 |  Cooling Cycle Time | Cycle time for cooling output | 1-300 seconds Default: 10. |
| 54 |  Conversion Filter | ADC filter: number of means on analog-digital conversions |  (Disabled)  (2 Samples Mean)  (3 Samples Mean)  (4 Samples Mean)  (5 Samples Mean)  (6 Samples Mean)  (7 Samples Mean)  (8 Samples Mean)  (9 Samples Mean)  (10 Samples Mean) Default  (11 Samples Mean)  (12 Samples Mean)  (13 Samples Mean)  (14 Samples Mean) |

| | | | |
|----|--|---|--|
| | | | 155n (15 Samples Mean) |
| 55 |  Conversion Frequency | Frequency of sampling of analog-digital converter | 242H (242 Hz) 123H (123 Hz) 62 H (62 Hz) 50 H (50 Hz) 39 H (39 Hz) 33.2H (33.2 Hz) 19.6H (19.6 Hz) 16.7H (16.7 Hz) Default 12.5H (12.5 Hz) 10 H (10 Hz) 8.33H (8.33 Hz) 6.25H (6.25 Hz) 4.17H (4.17 Hz) |
| 56 |  Visualisation Filter | Visualisation filter | d.5 (Disabled) Default F.1 (First Order) 2.5n (2 Samples Mean) 3.5n (3 Samples Mean) 4.5n (4 Samples Mean) 5.5n (5 Samples Mean) 6.5n (6 Samples Mean) 7.5n (7 Samples Mean) 8.5n (8 Samples Mean) 9.5n (9 Samples Mean) 10.5n (10 Samples Mean) |
| 57 |  Tune | Tuning type selection | d.5 (Disabled) Default Auto (Automatic) PID parameters are calculated at activation and change of set. Man (Manual) Launch from keys or digital input. |

| | | | |
|----|--|---|--|
| 58 |  Setpoint Deviation Tune | Select the deviation from the command setpoint, for the threshold used by autotuning to calculate the PID parameters | 0-5000 digit* (tenths of degree if temperature). Default: 10. |
| 59 |  Operating Mode | Select operating mode |  (Controller) Default  (Programmed Cycle)  (2 Thresholds Switch)  (2 Thresholds Switch Impulsive)  (3 Thresholds Switch Impulsive)  (4 Thresholds Switch Impulsive)  (Time Reset)  (Programmed Cycle Start/Stop) |
| 60 |  Automatic / Manual | Enable automatic/manual selection |  (Disabled) Default  (Enabled)  (Enabled Stored) |
| 61 |  Digital Input | Digital input functioning (P59 selection must be  or ) |  (Disabled) Default: 0.  (Start/Stop)  (Run n.o.)  (Run n.c.)  (Lock Conversion n.o.)  (Lock Conversion n.c.)  (Tune) Manual  (Automatic Manual impulse)  (Automatic Manual Contact) |

* The display of the decimal point depends on the setting of the parameter  and the parameter .

| | | | |
|----|---|--|--|
| 62 |  Gradient | Increase gradient for soft start or pre-programmed cycle | 0 disabled 1-9999 Digit/time* (degrees/hours with display of tenths if temperature) Default: 0. |
| 63 |  Maintenance Time | Maintenance time for pre-programmed cycle | 00.00-24.00 hh.mm Default: 00.00. |
| 64 |  User Menu Cycle Programmed | Allows the rise gradient and the maintenance time to be changed from the user menu, in pre-programmed cycle functioning |  (Disabled) Default  (Gradient)  (Maintenance Time)  (All) |
| 65 |  Visualization Type | Select visualization for display 1 and 2 |  (1 Process, 2 Setpoint) Default  (1 Process, 2 Hide after 3 sec.)  (1 Setpoint, 2 Process)  (1 Setpoint, 2 Hide after 3 sec.)  (1 Process, 2 Ampere.) |
| 66 |  Degree | Select degree type |  : Centigrade Default  : Fahrenheit |
| 67 |  Retransmission | Retransmission for output 0-10V or 4...20mA. (Select Jumper JP5, JP7 and JP9). Parameters 68 and 69 define the lower and upper limits of the scale. |  (Disabled) Default  (Volt Process)  (mA Process)  (Volt Command setpoint)  (mA Command setpoint)  (Volt Output Percentage)  (mA Output Percentage)  (Volt Alarm 1 setpoint) |

* The display of the decimal point depends on the setting of parameter 

and parameter .

| | | | |
|----|-----------------------------------|---|---|
| | | | (mA Alarm 1 setpoint) (Volt Alarm 2 setpoint) (mA Alarm 2 setpoint) (Volt A.T.) (mA A.T.) |
| 68 | Lower Limit Retransmission | Lower limit range of linear output | -999...+9999 digit* (degrees if temperature) Default: 0. |
| 69 | Upper Limit Retransmission | Upper limit range of linear output | -999...+9999 digit* (degrees if temperature) Default: 1000. |
| 70 | Baud Rate | Select baud rate for serial communication | Default |
| 71 | Slave Address | Select slave address for serial communication | 1 – 254 Default: 254. |
| 72 | Serial Delay | Select serial delay | 0 – 100 milliseconds Default: 20. |

* The display of the decimal point depends on the setting of parameter and parameter .

12 Alarm Intervention Modes

Absolute Alarm or Threshold Alarm ($\boxed{A AL}$ selection)

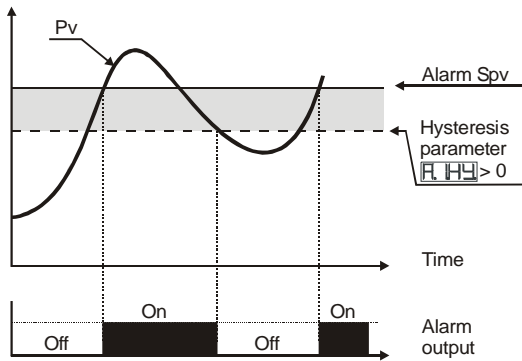

Absolute alarm with controller in heating functioning (Par.11 \boxed{ACEE} selected \boxed{HEAT}) and hysteresis value greater than "0" (Par.28 $\boxed{A HY} > 0$).

N.B.: The example refers to alarm 1; the function can also be enabled for alarms 2 and 3 on models that include it.

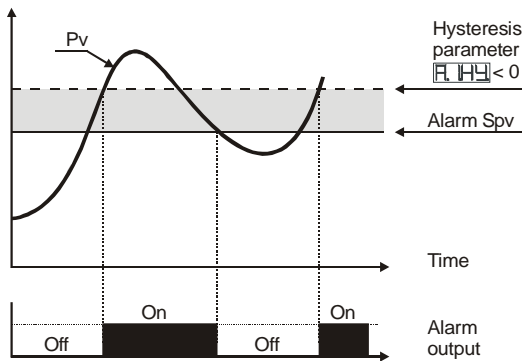

Absolute alarm with controller in heating functioning (Par.11 \boxed{ACEE} selected \boxed{HEAT}) and hysteresis value less than "0" (Par.28 $\boxed{A HY} < 0$).

N.B.: The example refers to alarm 1; the function can also be enabled for alarms 2 and 3 on models that include it.

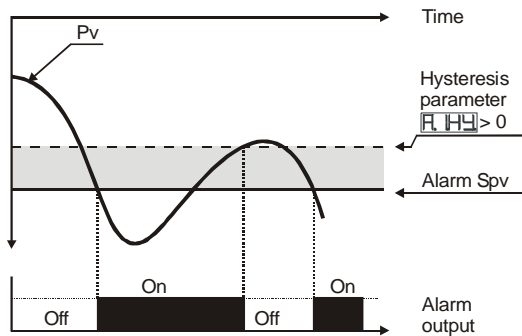

Absolute alarm with controller in cooling functioning (Par.11 \boxed{ACEE} selected \boxed{COOL}) and hysteresis value greater than "0" (Par.28 $\boxed{A HY} > 0$).

N.B.: The example refers to alarm 1; the function can also be enabled for alarms 2 and 3 on models that include it.

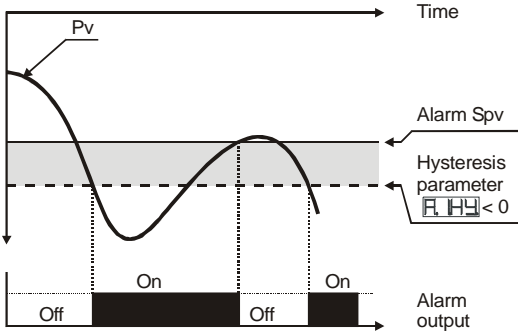

Absolute alarm with controller in cooling functioning (Par.11 **A.C.E.E.** selected **COOL**) and hysteresis value less than "0" (Par.28 **A.HY** < 0).

N.B.: The example refers to alarm 1; the function can also be enabled for alarms 2 and 3 on models that include it.

Absolute Alarm or Threshold Alarm Referring to Setpoint Command (**A.C.A.L.** selection)

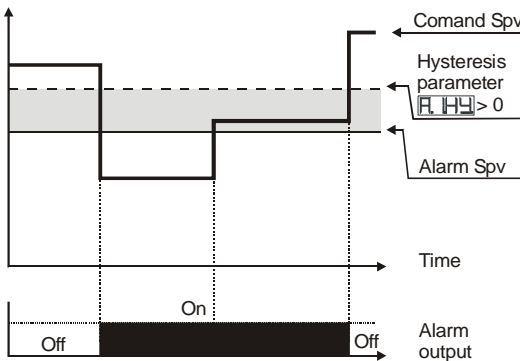

Absolute alarm refers to the command set, with the controller in heating functioning (Par.11 **A.C.E.E.** selected **HEAT**) and hysteresis value greater than "0" (Par.28 **A.HY** > 0).

The command set can be changed by pressing the arrow keys on front panel or using serial port RS485 commands.

N.B.: The example refers to alarm 1; the function can also be enabled for alarms 2 and 3 on models that include it.

Band Alarm (B.AL selection)

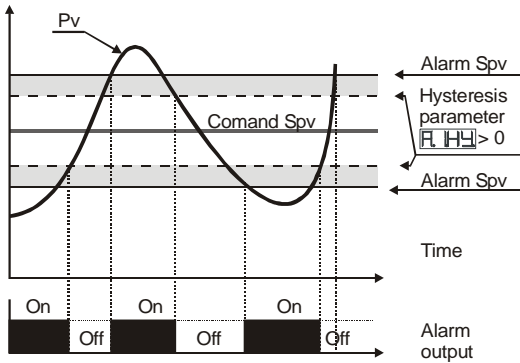

Band alarm hysteresis value greater than "0" (Par.28 $RA.HY > 0$).

N.B.: The example refers to alarm 1; the function can also be enabled for alarms 2 and 3 on models that include it.

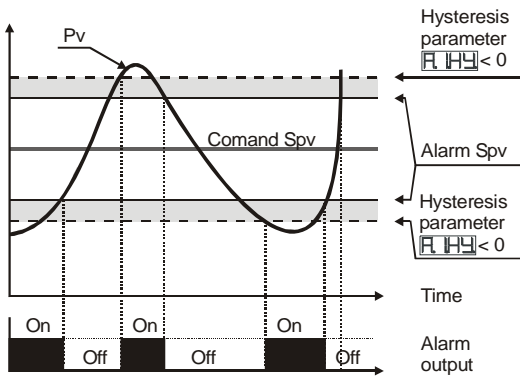

Band alarm hysteresis value less than "0" (Par.28 $RA.HY < 0$).

N.B.: The example refers to alarm 1; the function can also be enabled for alarms 2 and 3 on models that include it.

Upper Deviation Alarm (HdAL selection)

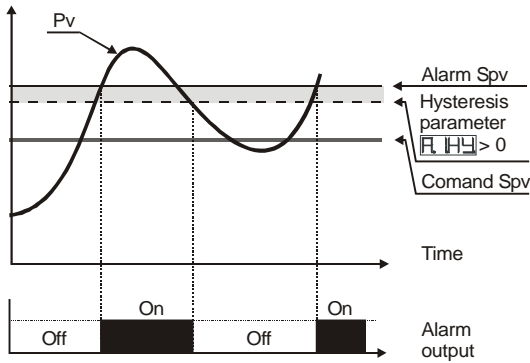

Upper deviation alarm value of alarm setpoint greater than “0” and hysteresis value greater than “0” (Par.28 $\text{R.149} > 0$).

N.B.:

a) The example refers to alarm 1; the function can also be enabled for alarms 2 and 3 on models that include it.

b) With hysteresis less than “0” ($\text{R.149} < 0$) the broken line moves above the alarm setpoint.

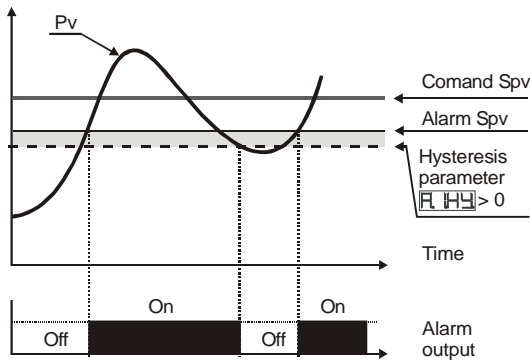

Upper deviation alarm value of alarm setpoint less than “0” and hysteresis value greater than “0” (Par.28 $\text{R.149} > 0$).

N.B.:

a) The example refers to alarm 1; the function can also be enabled for alarms 2 and 3 on models that include it.

b) With hysteresis less than “0” ($\text{R.149} < 0$) the broken line moves above the alarm setpoint.

Lower Deviation Alarm (\overline{HdAL} selection)

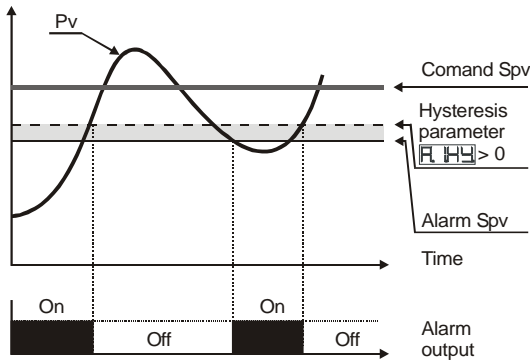

Lower deviation alarm value of alarm setpoint greater than "0" and hysteresis value greater than "0" (Par.28 $\overline{HdAL} > 0$).

N.B.:

- The example refers to alarm 1; the function can also be enabled for alarms 2 and 3 on models that include it.
- With hysteresis less than "0" ($\overline{HdAL} < 0$) the broken line moves under the alarm setpoint.

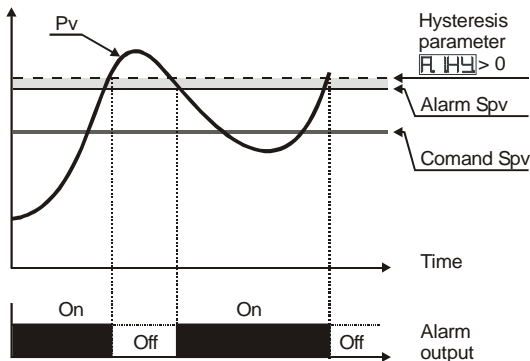

Lower deviation alarm value of alarm setpoint less than "0" and hysteresis value greater than "0" (Par.28 $\overline{HdAL} > 0$).

N.B.:

- The example refers to alarm 1; the function can also be enabled for alarms 2 and 3 on models that include it
- With hysteresis value less than "0" ($\overline{HdAL} < 0$) the broken line moves under the alarm setpoint.

13 Table of Anomaly Signals

In case of malfunctioning of the system, the controller switches off the regulation output and displays the type of anomaly.

For example the controller will signal the breakage of any connected thermocouple by displaying **E-05** (flashing) on display. For other notifications, see the table below.

| # | Cause | What to do |
|-------------|---|--|
| E-01 | Error in E ² PROM cell programming | Call Assistance |
| E-02 | Cold junction sensor fault or room temperature outside of allowed limits. | Call Assistance |
| E-04 | Incorrect configuration data. Possible loss of calibration values. | Check if the configuration parameters are correct. |
| E-05 | Thermocouple open or temperature outside of limits. | Check the connection with the sensors and their integrity. |

14 Summary of Configuration parameters

| | |
|-------------------|----------------------|
| Date: | Model ATR243: |
| Installer: | System: |
| Notes: | |

| | | |
|------------------|---|--|
| c.o.u.t | Command output type selection | |
| S.E.n | Analog input configuration | |
| d.P. | Number of decimal points | |
| L.o.L.S | Lower limit setpoint | |
| u.P.L.S | Upper limit setpoint | |
| L.o.L.l | Lower limit range An1 only for linear | |
| u.P.L.l | Upper limit range An1 only for linear | |
| L.A.t.c. | Automatic setting of linear input limits. | |
| o.c.A.L. | Offset calibration | |
| G.c.A.L. | Gain calibration | |
| R.c.t.t. | Regulation type | |
| c. r.E. | Command output reset type | |
| c. S.E. | Contact state for command output in case of error | |
| c. L.d | Define the OUT1 led state | |
| c. H.Y | Hysteresis in ON/OFF or dead band in P.I.D. | |
| c. d.E. | Command delay | |
| c. S.P. | Command setpoint protection | |
| P.b | Proportional band | |
| I. t | Integral time | |
| E.d | Derivative time | |
| t.c. | Cycle time | |
| o.P.o.L. | Limit of output power % | |
| A.L. 1 | Alarm 1 selection | |
| A. I.S.o | Alarm 1 output contact and intervention type | |
| A. r.E. | Reset type of alarm 1 contact. | |
| A. I.S.E. | State of contact for alarm 1 output | |
| A. I.L.d | State of OUT2 led | |

| | | |
|------|--|--|
| A1HY | Alarm 1 hysteresis | |
| A1DE | Alarm1 delay | |
| A1SP | Alarm 1 set protection | |
| AL 2 | Alarm 2 selection | |
| A2SO | Alarm 2 output contact and intervention type | |
| A2RE | Reset type of alarm 2 contact | |
| A2SE | State of contact for alarm 2 output | |
| A2LD | State of OUT2 led | |
| A2HY | Alarm 2 hysteresis | |
| A2DE | Alarm 2 delay | |
| A2SP | Alarm 2 set protection | |
| AL 3 | Alarm 3 selection | |
| A3SO | Alarm 3 output contact and intervention type | |
| A3RE | Reset type of alarm 3 contact | |
| A3SE | State of contact for alarm 3 output | |
| A3LD | State of OUT3 led | |
| A3HY | Alarm 3 hysteresis | |
| A3DE | Alarm 3 delay | |
| A3SP | Alarm 3 set protection | |
| EA | Activation and scale range of amperometric transformer | |
| LbAL | Intervention threshold of Loop break alarm | |
| LbAd | Delay time for Loop break alarm intervention | |
| COoF | Cooling fluid type | |
| PbN | Proportional band multiplier | |
| owdb | Overlapping/Dead band | |
| COtC | Cycle time for cooling output | |
| eFLE | Analog converter filter | |
| eFRn | Sampling frequency of analog converter | |
| uFLE | Display filter | |
| tunE | Autotuning type selection | |
| Sdte | Command setpoint deviation for tuning threshold | |
| oPNd | Operating mode | |
| AuNA | Automatic/manual selection | |

| | | |
|-------|--|--|
| dGE. | Digital input functioning | |
| GrAd | Gradient for soft start | |
| NAE. | Cycle maintenance time | |
| wGrP. | Gradient change and maintenance time by user | |
| u.ty. | Display data selection | |
| dEGr. | Degree type selection | |
| rEtr. | Retransmission for output 0-10V or 4...20mA | |
| LoLr. | Lower limit range for linear output | |
| uPLr. | Upper limit range for linear output | |
| bdrt. | Select baud rate for serial communication | |
| SLAd | Select slave address | |
| SEdE. | Select the serial delay | |

Notes / Updates

A series of horizontal dotted lines for writing notes or updates.

PIXSYS

Via Tagliamento, 18

30030 Mellaredo di Pianiga (VE)

www.pixsys.net

e-mail: sales@pixsys.net - support@pixsys.net

Software Rev. 1.03

2300.10.081-RevA EN 180707

*** 2300.10.081-A ***