

PRODUCT RANGE

M Measurement and Control	Fixed power analyzers	23
	Measuring current transformers and shunts	33
	Control devices	45
	Energy management software	48
	Portable power analyzers	49
	Digital instruments	53
	Analogue instruments	61
Q Metering	Multi-function electrical energy meters	81
	Partial consumption energy meters	90
P Protection and Control	Industrial earth leakage protection	95
	Earth leakage and circuit breaker protection with reclosing system	102
	Relays and control elements	109
	Protection current transformers	111
	Measuring and verification units	113
R Power factor correction and harmonic filtering	Reactive energy regulators	115
	Low Voltage Capacitors and Reactors	120
	Low-Voltage Capacitor Banks	133
	Harmonic filters	145
	Medium Voltage Capacitors and Equipment and Accessories	149
	Medium Voltage Capacitor Banks	152
V Smart electric vehicle charging	Outdoor electric vehicle charging	155
	Indoor electric vehicle charging	156
	Accessories	157
E Renewable energies	Instantaneous self-consumption	161
	Self-consumption with storage	165
	Units for photovoltaic applications	163

CIRCUTOR Profile

Since 1973, CIRCUTOR has specialised in the design, manufacture and marketing of energy efficiency equipment: measurement and control equipment for electricity, supply quality, industrial electrical protection, reactive energy compensation and harmonic filtration.

M Q P R U E

The production capacity of CIRCUTOR is based on six production centres throughout Spain and the Czech Republic.

CIRCUTOR has committed itself to following the latest technological advances in order to add them to its products. It has its own test technology and laboratories that enable it to guarantee the quality of all its products.

The company is present in more than 100 countries, with offices in Argentina, Mexico, Germany, China, Singapore, India, Portugal, Czech Republic, etc.

CIRCUTOR holds certification in:

- Quality (ISO 9001)
- Health and Environment (ISO 14001)
- Safety (OSHAS 18001)
- Management System (ISO 50001)



Head office of
CIRCUTOR, SA
in Viladecavalls



■ Two of the production centres of CIRCUTOR





Own technology

Team composed of more than 60 engineers

CIRCUTOR has an R+D+i team composed of more than 60 engineers that design new products to satisfy the market demand, incorporating the most advanced technologies.



Testing laboratory

Official metrological verification laboratory

CIRCUTOR has its own laboratories to perform electromagnetic compatibility tests (EMC/EMI), calibration tests and an official metrological verification laboratory to guarantee the quality of all its products and make sure they comply with the highest quality standards.



Innovation with new products

Innovating with new electrical energy efficiency solutions

CIRCUTOR has a commitment to innovation, in order to bring out products with the latest technology and the best added value.



Production capacity

All of our production centres use state-of-the-art technology to guarantee a high production capacity.

To meet market needs regarding energy efficiency, **CIRCUTOR** has a large team of engineers and production centres, equipped with the most up-to-date technology.

COMPLETE SOLUTIONS



**PHOTOVOLTAIC
ENERGY**
Page 6



**TRANSMISSION AND
DISTRIBUTION OF
ELECTRIC ENERGY**
Page 10



WIND ENERGY
Page 8



**INDUSTRIAL SECTOR /
TERTIARY**
Page 12



**CRITICAL
INSTALLATIONS**
Page 14



**SMART CHARGE OF
ELECTRIC VEHICLES**
Page 16



INFRASTRUCTURES
Page 18



SELF-CONSUMPTION
Page 20

Solutions for photovoltaic installations

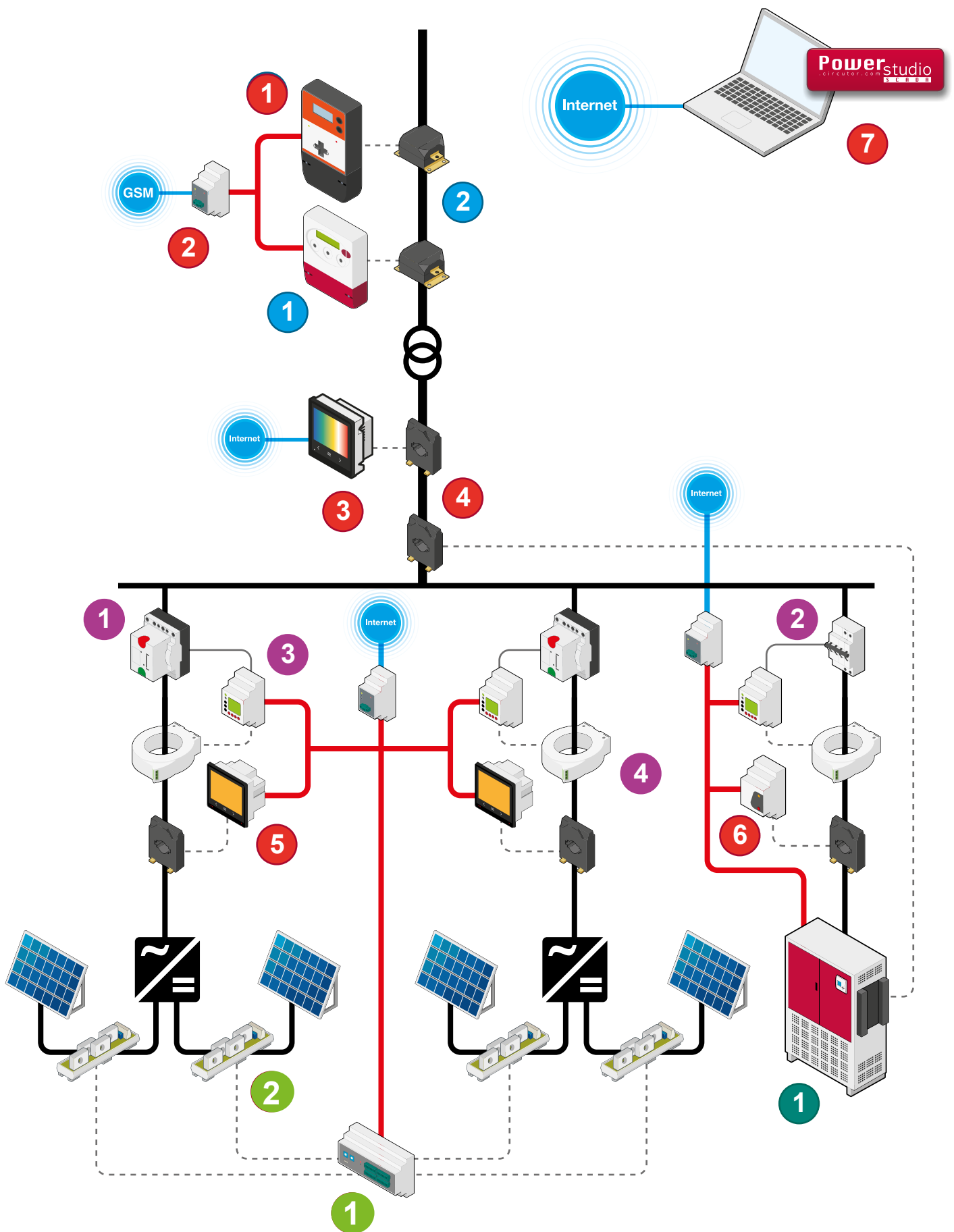



Related Products

Measurement and electric control

No.	Type	Name
1	Power and quality analyzer	QNA 500
2	RS-485/RS-232 to Ethernet converter	TCP1RS+
3	Three-phase power analyzer	CVM-B150
4	Current measurement transformer	TC
5	Three-phase power analyzer	CVM C5
6	Three-phase power analyzer	CVM NET
7	Energy Management Software	PowerStudio SCADA

Electric protection and control

No.	Type	Name
1	Motorized circuit breaker for more than 63 A	MT-FDE
2	Motorized circuit breaker up to 63 A	RECmax P
3	Earth leakage relay	RGU-10 MT
4	Earth leakage transformer	WGC

Metering

No.	Type	Name
1	Multifunction three-phase energy meter	CIRWATT B 410 T
2	Current transformer	TRMC

Power Factor correction and harmonic filtering

No.	Type	Name
1	LV Static automatic capacitor bank with detuned filters	OPTIM FRE

Renewable energies

No.	Type	Name
1	Measurement device for photovoltaic strings	TRH16
2	Measurement module for photovoltaic strings	MTR-25

Solutions for wind energy installations

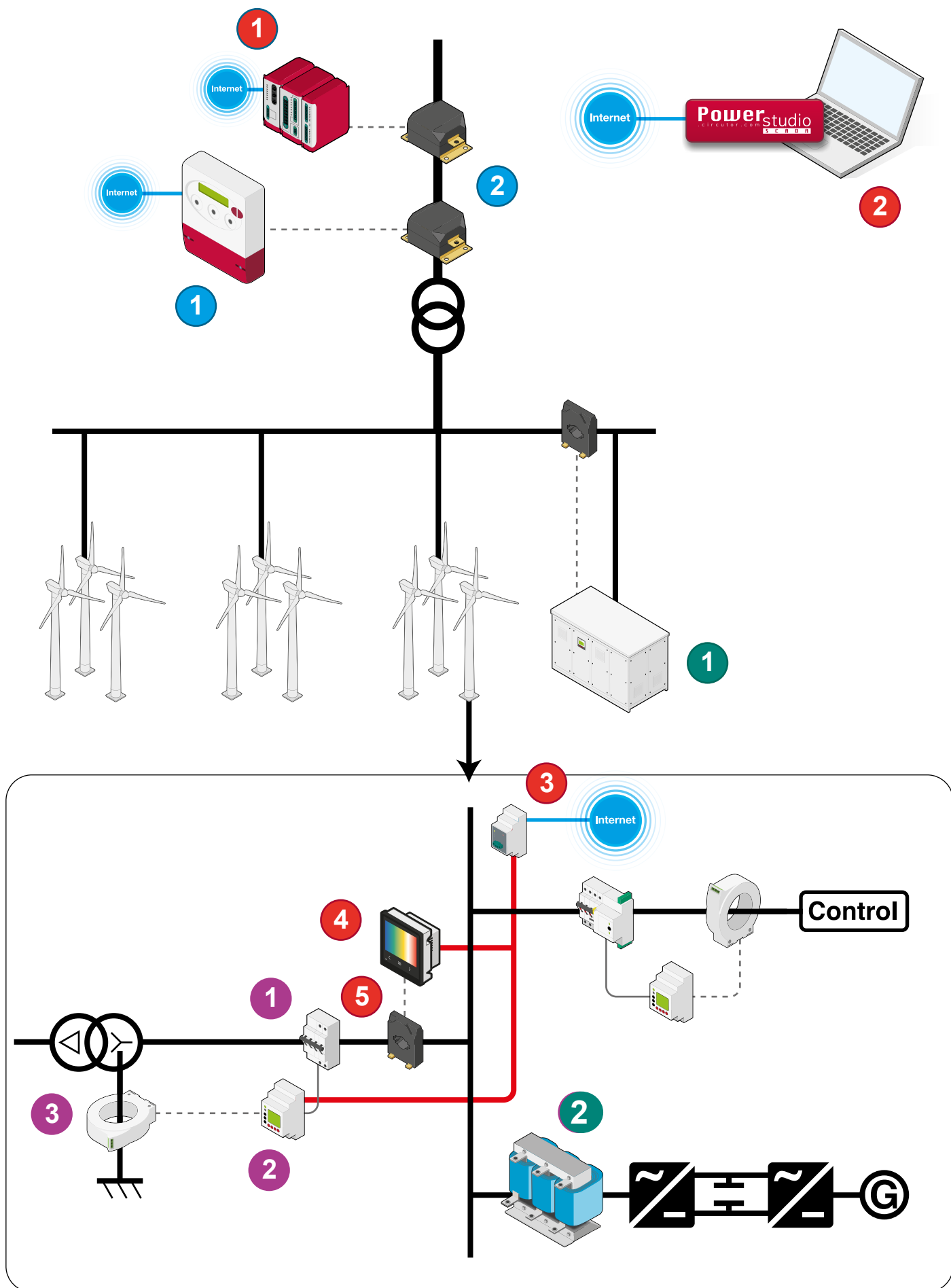



Related Products

Measurement and electric control

No.	Type	Name
1	Power quality analyzer	QNA 500
2	Energy management software	PowerStudio SCADA
3	RS-485/RS-232 to Ethernet converter	TCP2RS+
4	Three-phase power and quality analyzer	CVM-A
5	Current measurement transformer	TC

Electric protection and control

No.	Type	Name
1	Motorized circuit breaker for more than 63 A	RECmax-MP
2	Earth leakage relay	RGU-10 MT
3	Earth leakage transformer	WGC

Metering

No.	Type	Name
1	Multifunction three-phase energy meter	CIRWATT B 410 T
2	Current transformer	TRMC

Power Factor correction and harmonic filtering

No.	Type	Name
1	MV Capacitor Bank	CIRKAP
2	Reactors for filtering	RBX

Solutions for Transmission and distribution of electric energy

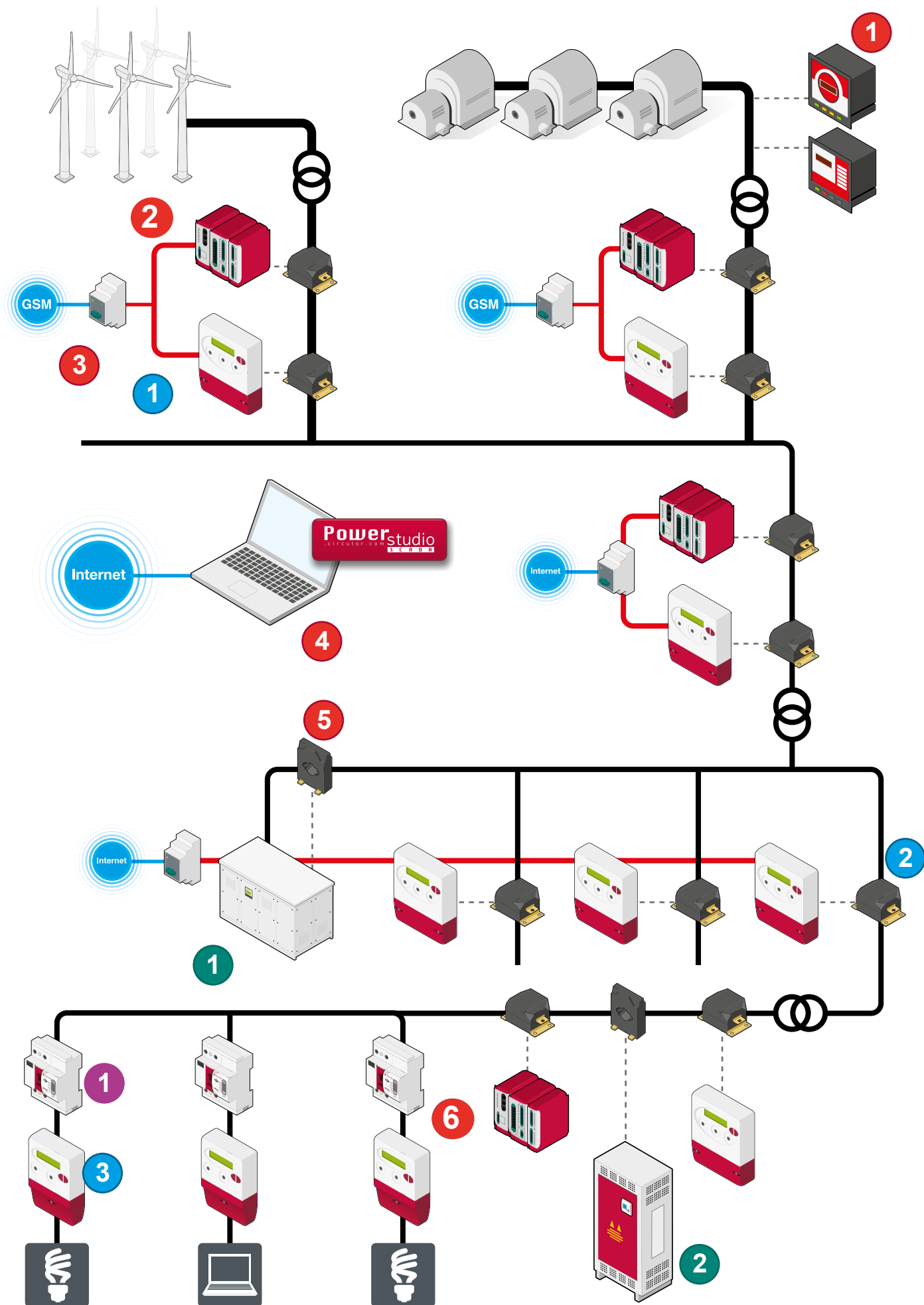

Related Products

Measurement and electric control

No.	Type	Name
1	RS-485/RS-232 to Ethernet converter	Synchro MAX
2	Current measurement transformer	QNA 500
3	Synchronization device	TCP2RS+
4	Energy management software	PowerStudio SCADA
5	Power quality analyzer	TC
6	Modular power quality analyzer	QNA 500

Electric protection and control

No.	Type	Name
1	RCCB switch with automatic self reclosing system	REC3

Metering

No.	Type	Name
1	Multifunction three-phase energy meter	CIRWATT B 410 T
2	Current transformer	TRMC
3	Single-phase energy meter	CIRWATT B 101

Power Factor correction and harmonic filtering

No.	Type	Name
1	MV Capacitor Bank	CIRKAP
2	LV Automatic capacitor bank	OPTIM P&P

Solutions for buildings and industry

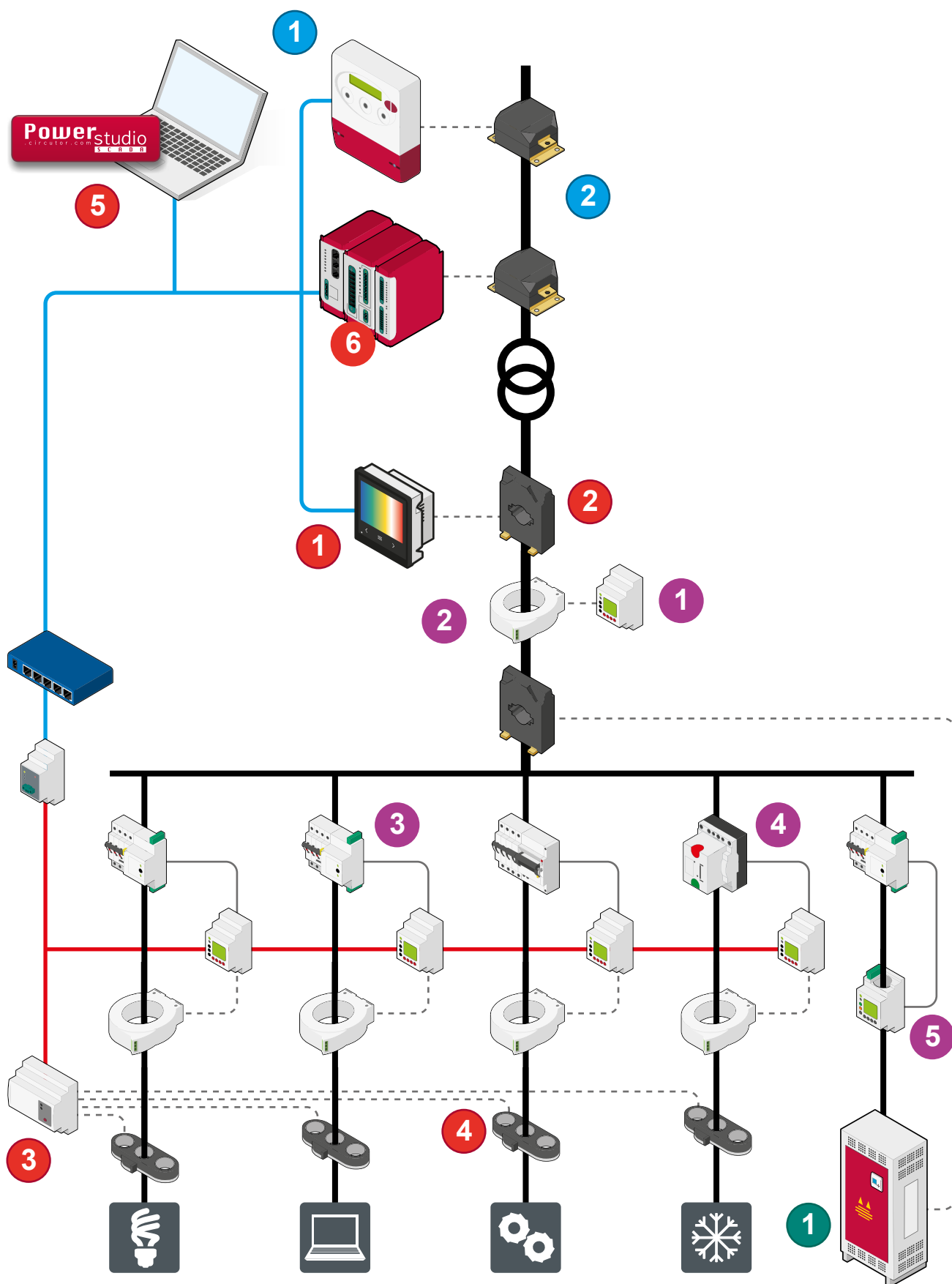



Related Products

Measurement and electric control

No.	Type	Name
1	Three-phase power analyzer	CVM-B150
2	Current measurement transformer	TC
3	Power analyzer for 4 three-phase lines	CVM NET4+
4	Efficient current transformers	MC-3
5	Energy management software	PowerStudio SCADA
6	Modular power quality analyzer	QNA 500

Electric protection and control

No.	Type	Name
1	Earth leakage relay	RGU-10
2	Earth leakage transformer	WGC
3	Motorized circuit breaker up to 63 A	RECmax P
4	Motorized circuit breaker for more than 63 A	MT-FDE
5	Earth leakage relay with built-in transformer	WRU-10 MT + RECmax-MP

Metering

No.	Type	Name
1	Multifunction three-phase energy meter	CIRWATT B 410 T
3	Current transformer	TRMC

Power Factor correction and harmonic filtering

No.	Type	Name
1	LV Automatic capacitor bank	OPTIM P&P

Solutions for critical installations

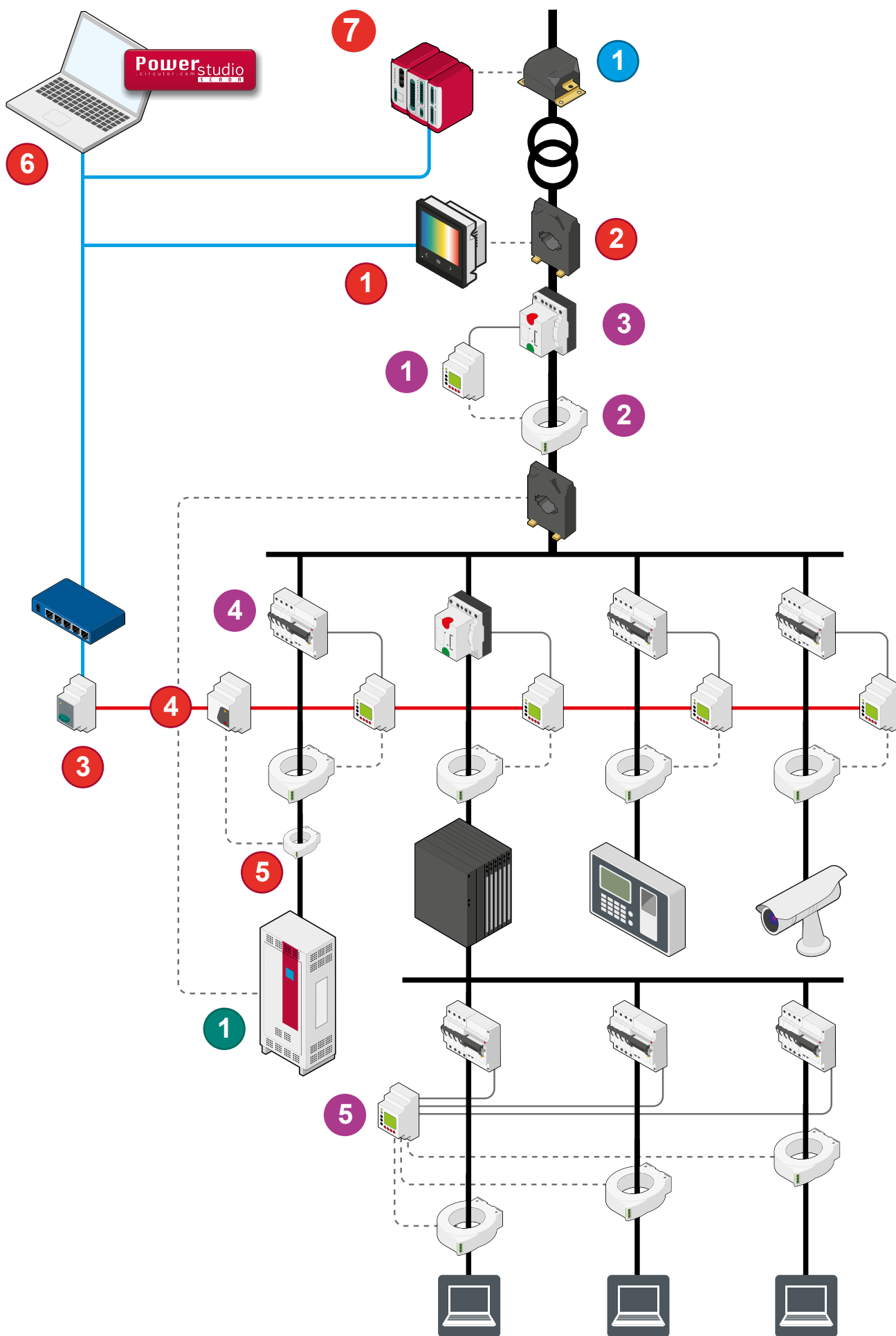



Related Products

Measurement and electric control

No.	Type	Name
1	Three-phase power analyzer	CVM-B150
2	Current measurement transformer	TC
3	RS-485/RS-232 to Ethernet converter	TCP1RS+
4	Three-phase power analyzer	CVM NET
5	Efficient current transformer	MC-1
6	Energy management software	PowerStudio SCADA
7	Power and quality analyzer	QNA 500

Electric protection and control

No.	Type	Name
1	Earth leakage relay	RGU-10
2	Earth leakage transformer	WGC
3	Motorized circuit breaker for more than 63 A	MT-FDE
4	Motorized circuit breaker up to 63 A	RECmax P
5	Multipeint earth leakage scanning system	CBS4

Metering

No.	Type	Name
1	Current transformer	TRMC

Power Factor correction and harmonic filtering

No.	Type	Name
1	Multifunction active filter	AFQevo

Solutions for smart charge of electric vehicles

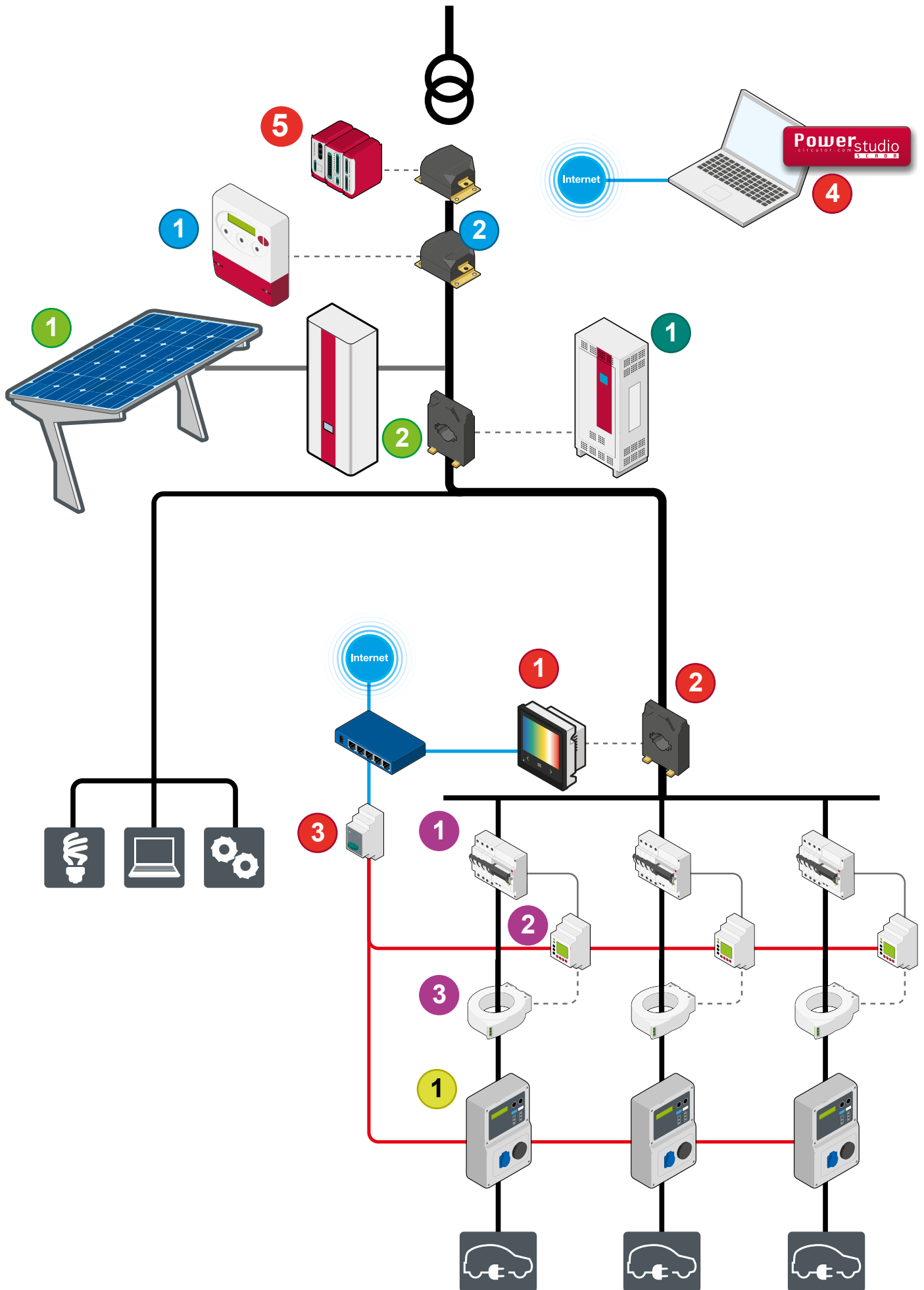



Related Products

Measurement and electric control

No.	Type	Name
1	Three-phase power and quality analyzer	CVM-A
2	Current measurement transformer	TC
3	RS-485/RS-232 to Ethernet converter	TCP2RS+
4	Energy management software	PowerStudio SCADA
5	Power and quality analyzer	QNA 500

Electric protection and control

No.	Type	Name
1	Motorized circuit breaker for more than 63 A	RECmax P
2	Earth leakage relay	RGU-10
3	Earth leakage transformer	WGC

Metering

No.	Type	Name
1	Multifunction three-phase energy meter	CIRWATT B 410T
2	Current transformer	TRMC

Power Factor correction and harmonic filtering

No.	Type	Name
1	Multifunction active filter	AFQevo

Smart charge for electric vehicles

No.	Type	Name
1	Electric vehicle charging box for car parking	RVE-WB / URBAN / RAPTION

Renewable energies

No.	Type	Name
1	Kits for instantaneous self-consumption on solar	PV
2	Hybrid inverters with battery charging	CirPower

Solutions for infrastructures

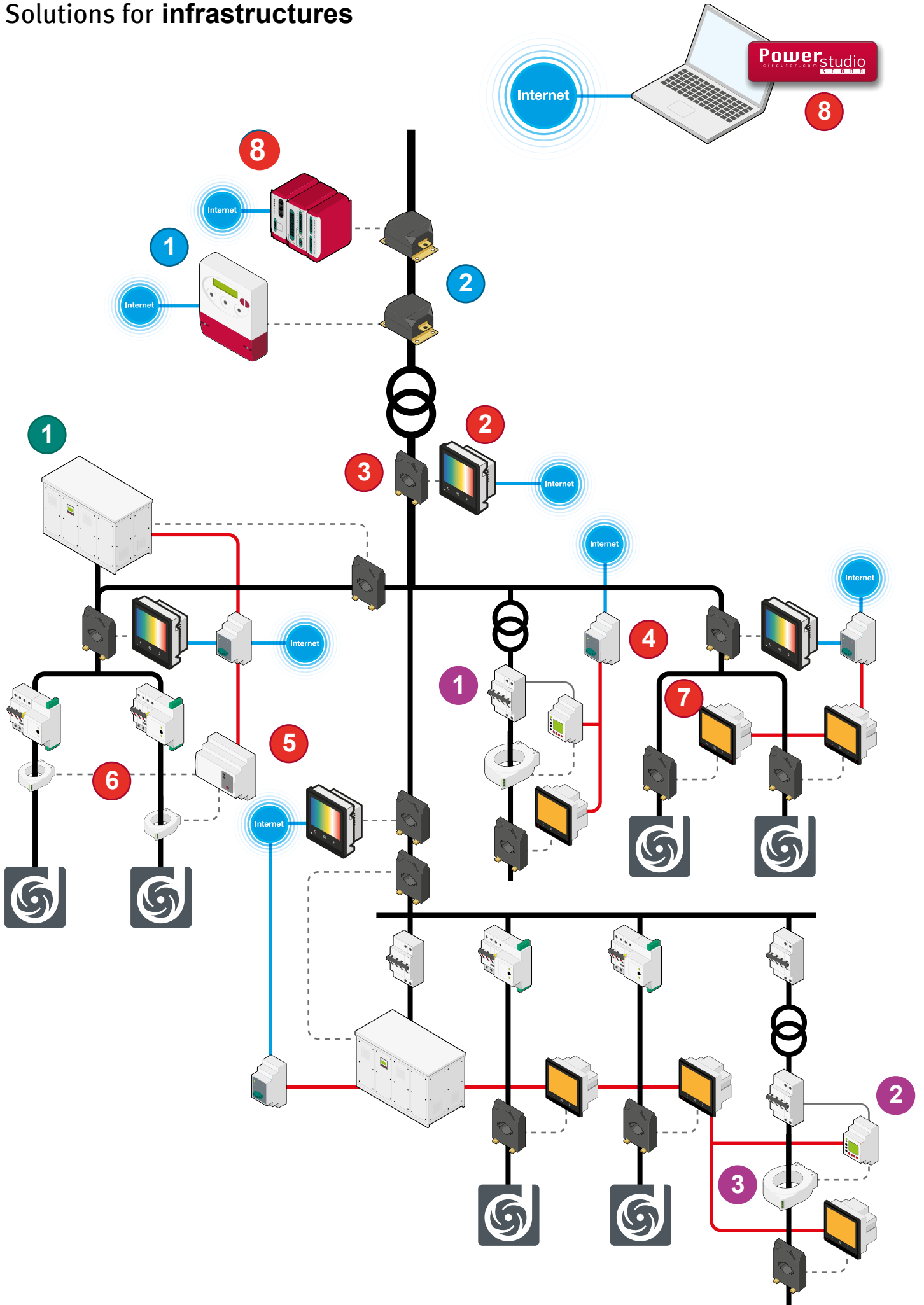



Related Products

Measurement and electric control

No.	Type	Name
1	Power and quality analyzer	QNA 500
2	Three-phase power and quality analyzer	CVM-A
3	Current measurement transformer	TC
4	RS-485/RS-232 to Ethernet converter	TCP1RS+
5	Power analyzer for 4 three-phase lines	CVM NET4+
6	Efficient current measurement transformer	MC-1
7	Three-phase power analyzer	CVM C10
8	Energy management software	PowerStudio SCADA

Electric protection and control

No.	Type	Name
1	Motorized circuit breaker up to 63 A	RECmax P
2	Earth leakage relay	RGU-10
3	Earth leakage transformer	WGC

Metering

No.	Type	Name
1	Energy meter	CIRWATT B401T
2	Current transformer	TRMC

Power Factor correction and harmonic filtering

No.	Type	Name
1	MV Capacitor Bank	CIRKAP

Solutions for self-consumption

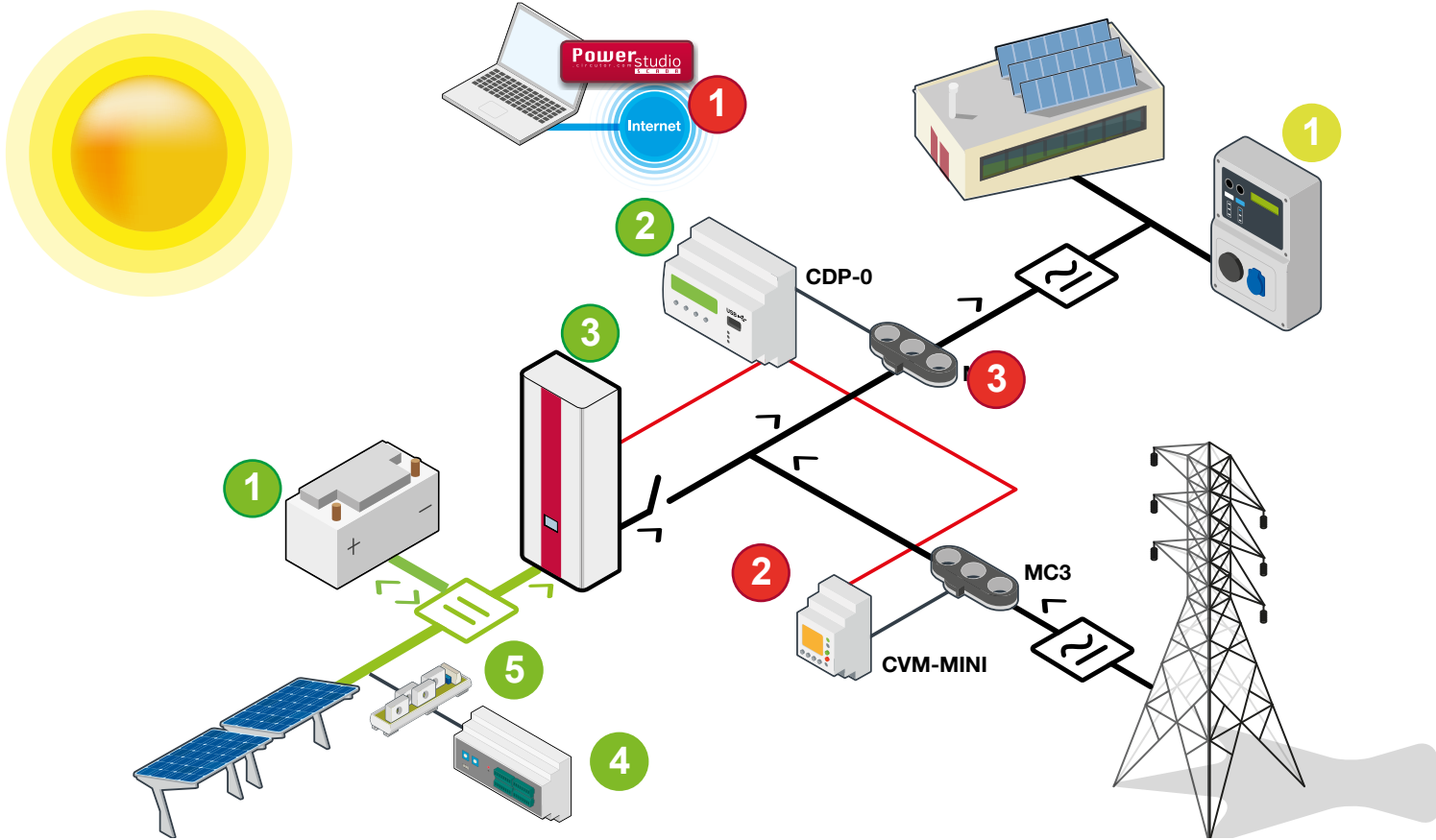

Related Products

Measurement and electric control

No.	Type	Name
1	Energy management software	PowerStudio SCADA
2	Three-phase power analyzer	CVM MINI
3	Measurement transformer	MC

Renewable energies

No.	Type	Name
Kit EMF-CDP (includes the following devices)		
1	Battery	
2	Battery and Conversion Supervisory Controller	CDP
3	Hybrid inverters with battery charging	CirPower
4	Measurement device for photovoltaic strings	TRH16
5	Measurement module for photovoltaic strings	MTR-25

Smart charge for electric vehicles

No.	Type	Name
1	Electric vehicle charging box for car parking	RVE-WB / URBAN / RAPTION

MEASUREMENT AND CONTROL

Fixed power analyzers

Table: Power analyzer selection.....	23
CVM-A, Power quality analyzers, colour display, panel mounted.....	24
CVM-B, Power analyzer, colour display, panel mounted.....	24
M-CVM-AB, Expansion modules for CVM-A and CVM-B.....	24
CVM-C10, Power analyzer, panel mounted 96 x96.....	25
FLEX-MAG, Flexible sensors for CVM-C10-FLEX.....	25
CVM-C5, Power analyzer, panel mounted 96x96.....	25
CVM-MINI, Power analyzer, three-phase DIN rail.....	26
CVM-NET, Power analyzer, three-phase DIN rail.....	26
CVM-NET4, Power analyzer, 4 analyzers in a single unit, DIN rail.....	26
CEM-6, Single-phase energy meter with basic analyser parameters.....	26
Wibeee, Consumption analyzers.....	27
Wibeee Max, Consumption analyzers.....	27
CVM-A, Power quality analyzers, colour display, panel mounted.....	29
QNA500, Advanced power quality analyzers (according Standard EN-50160 and IEC-61000-4-30).....	29
RS/TCP/CMBUS, Communication converters.....	30
AIR, Wireless converters and probes.....	30
Modems, Communication accessories.....	30
MC1, Triple scale single-phase efficient transformers.....	30
MC3, Three-phase current transformers.....	30
SC3, Split three-phase current transformers.....	30
PowerStudio, Energy management software.....	31

Measuring transformers and shunts

Table: Current transformers and shunts selection.....	33
TC, Current transformers narrow section.....	33
TCH, Current transformers narrow section and high accuracy.....	35
TP, Current transformers, split core.....	36
STP, Current transformers, split core.....	37
MC1, Triple scale single-phase efficient transformers.....	37
MC3, Three-phase current transformers.....	37
SC3, Split three-phase current transformers.....	37
TM45, Current transformers, winding primary, DIN rail.....	37
TA 210, Current transformers, winding primary.....	38
TA, Current transformers, winding primary.....	38
kit3-TRMC210, Sets of 3 current transformers for energy meters class 0,5S.....	39
kit3-TRMC400, Sets of 3 current transformers for energy meters class 0,5S.....	39
TRMCx3, Current transformers for energy meters.....	39
TRM, Measuring transformers encapsulated in resin.....	40
SH, Shunts.....	41
VT, Transformador de medida de tensión.....	42
TSR, Transformador sumador.....	42
TE, Transformador elevador.....	42

Control devices

EDS, Energy manager with powerStudio and built-in web server.....	45
LM, Impulse and contact centralisers.....	45
MDC, Maximum demand control devices.....	46
CirLAMP, Public lighting control system.....	46
TH-DG, Photovoltaic monitoring.....	46
ReadWatt, Impulse collection with communication.....	46
RS/TCP/CMBUS, Communication converters.....	46
AIR, Wireless converters and probes.....	47
Modems, Communication accessories.....	47

Management Software

PowerVision/CIR-ENERGY, Energy management software.....	48
PowerStudio, Energy management software.....	48
Databox, Plataforma cloud.....	48
SBOX, Gateway for DataBox platform.....	48

Portable power analyzers

Table: Portable power analyzers	49
MYeBOX, Portable power analyzer with recording of quality events and transients in accordance with (IEC 61000-4-30 Ed.2) Class A	50
MYeBOX-A, Portable power analyzer with recording of quality events and transients Calibration Certificate (IEC 61000-4-30 Ed.2) Class A	50
CPG, Clamps	50
FLEX-RMG,	50
Pinzas FLEX-R,	51
Accesor-MYeBOX, Accessories	51
CIR-e+, Energy audit analyzer	51
CPG, Clamps	51
FLEX, Flexible Clamps	51
Cire+ accesorios	51
CAVA, Power Quality Single-Phase Analyzers	52
VLOG, Power quality analyzer	52
Accessories	52

Digital instruments

Table: Digital instruments selection	53
DM45, Digital instruments	53
DC-B, Digital instruments	54
Accessories digital instruments	54
DHB, Digital instruments	55
DH96, DC multimeter	55
CVE/CCE/CFE, Narrow section transducers	56
CV, Transducer Voltage	56
CC, Current transducer	56
CW / CY, Power transducer	57
CPF / CCOS, Power Factor & Cos ϕ transducer	57
CF, Frequency transducers	57
Temp, Ohm, aislam, proceso, Transducers	57
TI, Current transformer with converter 4...20 mA	58
TC-020, Current transformers with converter 4...20 mA or 0...20 mA	58
Narrow section transducers	59
Transducers	59
Analogue instrument selection table	61

Analogue instruments

EC / EM / EZC / CEC, Moving Iron Miliammeters and Ammeter	62
EC / EM / EZC / CEC, Moving Iron Voltmeters	65
BC / BM / CBC, Moving coil ammeters	67
BC / BM / CBC, Moving coil voltmeters	68
BC / BM / ZC, Process indicators	69
MC / MMC / EMC, maximeter ammeters	71
HC / HM / HZC / HLC, Frequency meters	72
WMC / WTC / YMC / YTC, Wattmeters and varmeters	73
FEMC / FETC / FMZ / FTC / PIC, Phasemeters	75
PGR, Protection vatmeters	76
2EC, Double voltmeters	77
SMC / STC, Synchrosopes, 50 Hz	77
SynchroMAX, Synchronization equipment	77
2HC / 2HLC, Double frequency meters	77
UC / CUC, Phase sequence indicators, 50 Hz	77
CH, Hour run meters	78
MEG-1000, Insulation resistance meter	78
Accessories / Options for analogue instruments	79
Dimensions	79

Fixed power analyzers

			Page
Power analyzers	Panel	CVM A1500, CVM B150, CVM B100, CVM C10, CVM C5	25
	DIN rail	CVM 1D, CVM MINI, CVM NET, CVM NET4+, CVM BD, CEM-C6	
Power quality analyzers	Panel	CVM A1500	29
	DIN rail / Wall-mounted	QNA500	
Consumption analyzers	DIN zero	Wibeee	27
	Wall-mounted	Wibeee Max	

Table: Power analyzer selection

		CVM-A1500	CVM-B150 CVM-B100	CVM-C10	CVM-C5	CVM MINI	CVM NET	CVM NET4+	CEM-6	Wibeee	Wibeee MAX
Mounting	Panel (mm)	144x144	144x144 / 96x96	96x96	96x96	-	-	-	-	-	•
	DIN rail (modules)	-	-	-	-	3	3	6	1	0	•
AC Measurement	Three-phase 3/4 wires	Config	Config	Config	Config	•	•	•	-	T	•
	Single-phase	Config	Config	Config	Config	-	-	•	•	T	-
	Quadrants	4	4	4	4	4	4	4	2	2	2
	Hamonics	63	50	31	-	T(15)	-	15	-	-	•
	Phase parameters	•	•	•	•	•	•	•	•	•	•
	Maximum demand	•	•	•	•	•	•	•	-	-	-
	Tariffs	3	3	3	2	1	1	1	1	web	web
	Hours, cost, kgCO ₂	•	•	•	•	-	-	-	-	cost, kgCO ₂	cost, kgCO ₂
Voltage input	Direct (V)	600 V _{ph-n} * 1000 V _{ph-ph} *	600 V _{ph-n} * 1000 V _{ph-ph} *	300 V _{ph-n} 520 V _{ph-ph}	300 V _{ph-n} 520 V _{ph-ph}	300 V _{ph-n} 520 V _{ph-ph}	300 V _{ph-n} 520 V _{ph-ph}	300 V _{ph-n} 520 V _{ph-ph}	230 V _{ph-n}	85...265 V _{f-n} 147...459 V _{f-ph}	95...440 V _{f-n}
	Indirect (V)	Config.	Config.	Config.	Config.	Config.	Config.	Config.	-	-	-
Current Input	Direct	-	-	-	-	-	-	-	100 A	70 A max.	-
	Indirect (ITF)	•	•	•	T	T	T	-	-	-	-
	MC System (/250 mA)	•	•	T	T	T	T	•	-	-	-
	Rogowski sensors	-	-	T	-	-	-	-	-	-	•
Communications	RS-232	-	-	-	-	-	-	-	-	-	-
	RS-485	•	•	•	T	T	•	•	•	-	-
	TCP/IP	•	OP	-	-	T	-	-	-	-	-
	WIFI	-	-	-	-	-	-	-	-	•	•
Protocols	ModBus/RTU	•	•	•	T	T	•	•	•	-	-
	ModBus/TCP	OP	OP	-	-	T	-	-	-	•	•
	XML	•	OP	-	-	-	-	-	-	-	-
	MBUS	OP	OP	-	-	-	-	-	-	-	-
	BACnet	•	•	•	-	T	-	-	-	-	-
	Profibus	OP	OP	-	-	-	-	-	-	-	-
LonWorks	OP	OP	-	-	T	-	-	-	-	-	
Otthers	Display	colour graph	colour graph	custom LCD	LCD	LCD	-	-	LCD	APP	APP
	Expandible	•	•	-	-	-	-	-	-	-	-
Optional	Digital inputs (n.max)	•(2)	•(2)	•(2)	•1(T)	-	-	-	-	-	-
	Digital outputs (n.max)	•(4)	•(4)	•(4)	•1(T)	•(2)	•(2)	•(4)	•(1)	-	-
	Analogue inputs (n.max)	OP	OP	-	-	-	-	-	-	-	-
	Analogue outputs (n.max)	OP	OP	-	-	-	-	-	-	-	-
	Historical data record	•	OP	-	-	-	-	-	-	-	-
Standards	UL	•	•	•	•	T	-	-	-	-	-
	Measurement in acc. with MID	•	•	•	-	-	-	-	-	-	-
	Page	24	24	25	25	26	26	26	26	27	27

(T) - depending on the type / (OP) - Optional

NEW
CVM-A, Power quality analyzers, colour display, panel mounted

Power supply 85...265 Vac / 120...300 Vdc, 600 Vp-n / 1000 Vp-p measurement



Type	Code	Size(mm)	Energy accuracy	Current input	Transistor output	Output relay	Digital inputs	Commu-nications	Protocol
CVM-A150-ITF-485-ICT2	[*] M56311.	144x144	0,2S (.../5A)	.../5A, .../1A, 250 mA	2	2	2	RS-485, Ethernet	Modbus/BACnet, webserver (HTTP), XML, HTML5

4-quadrant measuring unit with PowerStudio embedded. Built-in Datalogger module. Optional Modbus/TCP.
See expansion modules and accessories (Sealing gaskets) for CVM-A / CVM-B.
Energy accuracy for module... /5 A

CVM-B, Power analyzer, colour display, panel mounted

Power supply 85...265 Vac / 120...300 Vdc, 600 Vp-n / 1000 Vp-p measurement



Type	Code	Size(mm)	Energy accuracy	Current input	Transistor output	Output relay	Digital inputs	Commu-nications	Protocol
CVM-B150-ITF-485-ICT2	[*] M56111.	144x144	0,5 S (.../5A)	.../5A, .../1A, 250 mA	2	2	2	RS-485	Modbus / BACnet
CVM-B100-ITF-485-ICT2	[*] M56011.	96x96	0,5 S (.../5A)	.../5A, .../1A, 250 mA	2	2	2	RS-485	Modbus / BACnet

4-quadrant measuring unit.
See expansion modules and accessories (Sealing gaskets) for CVM-A / CVM-B

M-CVM-AB, Expansion modules for CVM-A and CVM-B

Type	Code	Transistor output	Output relay	Digital inputs	Analogue Inputs	Analog output	Commu-nications	Protocol	Memory
M-CVM-AB-8I-8OTR	[*] M56E01.	8	-	8	-	-	-	-	-
M-CVM-AB-8I-8OR	[*] M56E02.	-	8	8	-	-	-	-	-
M-CVM-AB-4AI-8AO	[*] M56E03.	-	-	-	4 (0/4 ... 20mA)	8 (0/4 ... 20mA)	-	-	-
M-CVM-AB-Modbus-TCP (bridge)	[*] M56E05.	-	-	-	-	-	Ethernet	Modbus/TCP (pasarela a RS485)	-
M-CVM-AB-Modbus-TCP (switch)	[*] M56E0A.	-	-	-	-	-	Ethernet	Modbus/TCP (pasarela a TCP)	-
M-CVM-B-DATALOGGER	[*] M56E06.	-	-	-	-	-	Ethernet	Webserver, Java, XML	200 MB
M-CVM-AB-MBUS	[*] M56E07.	-	-	-	-	-	M-BUS	MBUS	-
M-CVM-AB-LonWorks	[*] M56E08.	-	-	-	-	-	LonWorks	LonTalk, ISO/IEC 14908, ANSI/EIA 7091	-
M-CVM-AB-Profibus	[*] M56E09.	-	-	-	-	-	DB-9	Profibus	-

Optocoupled transistor output

Type	Code	Description
IP65-AB-96	[*] M5ZZ5U.	IP 65 airtight seal for CVM-AB (96x96)
IP65-AB-144	[*] M5ZZ5V.	IP 65 airtight seal for CVM-AB (144x144)



CVM-C10, Power analyzer, panel mounted 96 x96

96x96 panel - 85...265 Vac / 95...300 Vdc power supply, 300 Vp-n / 520 Vp-p measurement

Type	Code	Measuring Channels	Current input	Transistor output	Output relay	Digital inputs	Communications	Protocol	Harmonics
CVM-C10-ITF-485-ICT2	[*] M55911.	3	.../5A , .../1A	2	2	2	RS-485	ModBus/BACnet	31
CVM-C10-MC-485-ICT2	[*] M55921.	3	.../250mA	2	2	2	RS-485	ModBus/BACnet	31
CVM-C10-ITF-IN-485-IC2	[*] M55942.	4	.../5A , .../1 A	-	2	2	RS-485	ModBus/BACnet	31
CVM-C10-mV-485-ICT2	[*] M559210000V00	3	.../333mV	2	2	2	RS-485	ModBus/BACnet	31
CVM-C10-FLEX-IN-485-I2	[*] M55963.	4	Rogowski	-	-	2	RS-485	ModBus/BACnet	31

4-quadrant measuring unit.

Units with 4 measuring channels, 3 phase current inputs + neutral current input (configurable, 3 or 4 current channels)

Type	Code	Description
IP64-C10-96	[*] M5ZZ5T.	IP 64 airtight seal for CVM-C10 (96x96)

FLEX-MAG, Flexible sensors for CVM-C10-FLEX

Type	Code	Measurement Range (A)	A (max.)	Usefull diam.(mm)	Sensor lenght
FLEX-MAG70	[*] M818110041500	1000 A / 100 mV	2000	70	2 m
FLEX-MAG120	[*] M818120041500	1000 A / 100 mV	2000	120	2 m
FLEX-BAY70	[*] M8181100418BA	1000 A / 100 mV	2000	70	2.5 m
FLEX-BAY120	[*] M8181200418BY	1000 A / 100 mV	2000	120	2.5 m



CVM-C5, Power analyzer, panel mounted 96x96

96x96 panel - 85...265 Vac / 95...300 Vdc power supply, 300 Vp-n / 520 Vp-p measurement

Type	Code	Measuring Channels	Current input	Transistor output	Digital inputs	Communications Protocol
CVM-C5-IC	[*] M55853.	3	.../5A , .../1 A	1	1	-
CVM-C5-MC-IC	[*] M55873.	3	.../250mA	1	1	-
CVM-C5-ITF-485-C	[*] M55884.	3	.../5A , .../1 A	1	0	RS-485 Modbus/RTU
CVM-C5-MC-485-C	[*] M55894.	3	.../250mA	1	0	RS-485 Modbus/RTU
CVM-C5-mV-485-C	[*] M558940000V00	3	.../333mV	1	0	RS-485 Modbus/RTU
CVM-C5-ITF-485-I	[*] M55885.	3	.../5A , .../1 A	0	1	RS-485 Modbus/RTU
CVM-C5-MC-485-I	[*] M55895.	3	.../250mA	0	1	RS-485 Modbus/RTU
CVM-C5-mV-485-I	[*] M558950000V00	3	.../333mV	0	1	RS-485 Modbus/RTU

4-quadrant measuring unit. Can be used to program the voltage transformer ratio

CVM-B, CVM-A

Code	Internal code	Delivery time
M 5 X X X X 0 0 X X X X X	0	-
Power supply voltage	Standard (85...265 V _{ac} / 120...300 V _{dc})	-
	20...120 V _{dc}	1
Others	Metric fork terminals 3 - CAT III 300 V	-

CVM C10

Code	Internal code	Delivery time
M 5 X X X X 0 0 X	0	-
Power supply voltage	Standard (85...265 V _{ac} / 120...300 V _{dc})	-
	20...120 V _{dc}	1

CVM-MINI, Power analyzer, three-phase DIN rail

DIN Rail (3 modules) - 230 Vac Power supply

Type	Code	Insulated input	Current input	Transistor output	Communications Protocol	Harmonics
CVM-MINI	[*] M52000.	-	.../5 A, .../1 A	-	-	-
CVM MINI-ITF-C2	[*] M52011.	1	.../5 A, .../1 A	2	-	-
CVM MINI-MC-ITF-C2	[*] M52071.	1	.../250mA	2	RS-485	Modbus/RTU
CVM-MINI-ITF-RS485-C2	[*] M52021.	1	.../5 A, .../1 A	2	RS-485	Modbus/RTU
CVM-MINI-MC-ITF-RS485-C2	[*] M52081.	1	.../250mA	2	RS-485	Modbus/RTU
CVM-MINI-HAR-ITF-RS485-C2	[*] M52031.	1	.../5 A, .../1 A	2	RS-485	Modbus/RTU U e l (15°)
CVM-MINI-ITF-ETH-C2	[*] M520J1.	1	.../5 A, .../1 A	2	TCP/IP	Modbus/TCP
CVM MINI-MC-ITF-ETH-C2	[*] M520L1.	1	.../250mA	2	TCP/IP	Modbus/TCP
CVM-MINI-ITF-BACnet-C2	[*] M520F1.	1	.../5 A, .../1 A	2	RS-485	BACnet
CVM-MINI-MC-ITF-BACnet-C2	[*] M520H1.	1	.../250mA	2	RS-485	BACnet
CVM-MINI-ITF-LonWorks-C2	[*] M52091.	1	.../5 A, .../1 A	2	LonWorks	Lon Talk ISO/ IEC 14908 ANSI/ EIA 709,1
CVM-MINI-mV-ITF-RS485-C2	[*] M520810000V00	1	.../333mV	2	RS-485	Modbus/RTU

CVM-MINI-MC units require efficient MC series transformers, which are not included in the price.
CVM-MINI-xx-BACnet units are only available with a 230 Vac power supply

Type	Code	Description
ADP CVM-MINI/ RGU10/CBS4	[*] M5ZZF1.	Panel adapter CVM MINI / RGU-10 / CBS-4 (72 x 72)

CVM-NET, Power analyzer, three-phase DIN rail

Analyser w/o display, DIN rail (3 modules) - 230 Vac Power supply



Type	Code	Current input	Transistor output	Communications	Protocol
CVM-NET-ITF-485-C2	[*] M54B21.	.../5 A	2	RS-485	Modbus/RTU
CVM-NET-MC-ITF-485-C2	[*] M54B31.	.../250mA	2	RS-485	Modbus/RTU
CVM-NET-333-485-C2	[*] M54B310000V00	.../333mV	2	RS-485	Modbus/RTU

The CVM-NET-MC units require the use of efficient transformers of the MC series, which are not included in the price.

CVM-NET4, Power analyzer, 4 analyzers in a single unit, DIN rail

Unit w/o display, DIN rail (6 modules) - 85...265 Vac / 95...300 Vdc Power supply



Type	Code	Current input	Transistor output	Communications	Protocol	Harmonics
CVM-NET4+-ITF- MC-RS485-C4	[*] M55782.	.../250mA	4	RS-485	Modbus/RTU	15°

Requires the installation efficient transformers of the MC series. Not included in the price Configurable, 4 three-phase channels to 12 single-phase channels

CEM-6, Single-phase energy meter with basic analyser parameters

Type	Code	Current	System	Phases order	Transistor output	Communications	Protocol
CEM-C6	[*] Q26112.	10 (100) A	Single-phase	Direct	1	RS-485	ModbusRTU

Parameters: V, A, kW, kVA, kWh, cos φ



CVM MINI / CVM NET

Code	Internal code	Delivery time
M 5 X X X X 0 0 X		
Power supply voltage	Standard 230 V _{ac}	0 -
	(*) 85...265 V _{ac}	C 1
	95...300 V _{dc}	
	24...120 V _{dc} (Only Type M52021)	5 1

(*) Not available in LonWork and BACnet models

**Wibeee, Consumption analyzers**

Type	Code	A (max.)	System	Phases order	Communications	Protocol
Wibeee-M-L	[*] M57010.	70	Single-phase	N-L	Wifi	HTTP / ModbusTCP / XML
Wibeee-M-R	[*] M57011.	70	Single-phase	L-N	Wifi	HTTP / ModbusTCP / XML
Wibeee-T-L	[*] M57020.	70	Three-phase	N-LIII	Wifi	HTTP / ModbusTCP / XML
Wibeee-T-R	[*] M57021.	70	Three-phase	LIII-N	Wifi	HTTP / ModbusTCP / XML
Wibeee-3P	[*] M57022.	70	Three-phase	LIII	Wifi	HTTP / ModbusTCP / XML

NEW

**Wibeee Max, Consumption analyzers**

Type	Code	Clamp	A (max.)	System	Phases order	Communications	Protocol
Wibeee Max	[*] M57023.	FLEX Wibeee25	350 / 700	Three-phase	Config.	Wifi	HTTP / ModbusTCP / XML
Wibeee Max Plus	[*] M57024.	FLEX Wibeee54	100 / 1000 / 5000	Three-phase	Config.	Wifi	HTTP / ModbusTCP / XML



NEW

Current sensor included

Wibeee Max-accessor, Accessories for WibeeeMAX

Type	Code	Description	Current
FLEX Wibeee14	[*] M570B1.	Flexible clamp for Wibeee Max/Max Plus (14 cm length)	350-700 A
FLEX Wibeee25	[*] M570B2.	Flexible clamp for Wibeee Max/Max Plus (25 cm length)	350-700 A
FLEX Wibeee54	[*] M570B3.	Flexible clamp for Wibeee Max/Max Plus (54 cm length)	100-1000-5000 A
B-Wibeee	[*] M570A2.	Wibeee Max carrying case	-
DIN-Wibeee	[*] M570A3.	Wibeee Max DIN accessory	-

Table: Power quality analyzers selection

		CVM-A1500	QNA500	QNA500-A
				
Assembly	Panel (mm)	144 x 144	-	-
	DIN rail (modules)	-	•	•
	Wall-mounted	-	•	•
Connection	Three-phase 3/4-wire	Config.	•	•
	Quadrants	4	4	4
Power supply		85-265V _{ac} / 120-300V _{dc} 20-120V _{dc} (OP)	90-300V _{ac} / 100-300V _{dc}	90-300V _{ac} / 100-300V _{dc}
Parameters	Parameters per phase	•	•	•
	Power	0,2	0,2	0,2
	Active energy	0,2S (.../5A)	0,2S	0,2S
	Reactive energy	1	0,5	0,5
	Maximum demand	•	•	•
	Harmonics	63	50	50
	THD U / THD I	•	•	•
	Tariffs	3	9	9
	Hours, cost, kgCO2	•	-	-
	Quality parameter measurements	Events (overvoltages, gaps and interruptions)	•	•
EN50160 parameters		•	•	•
Transients		•	•	•
Voltage input	Direct	600 V _{ph-N} 1000 V _{ph-ph}	500 V _{ph-N} 866 V _{ph-ph}	500 V _{ph-N} 866 V _{ph-ph}
	Indirect	Config.	Config.	Config.
Input Current	.../5 A	•	•	•
	.../1 A	•	•	•
	.../250 mA	•	-	-
Inputs/outputs	Digital inputs	2	OP	OP
	Digital outputs	2	OP	OP
	Relay outputs	2	OP	OP
Communications	RS-232	-	•	•
	RS-485	•	•	•
	TCP/IP	•	•	•
Interface	Colour screen	•	-	-
Protocols	ModBus/RTU	•	•	•
	ModBus/TCP	OP	•	•
	XML	•	-	-
	MBUS	OP	-	-
	BACnet	OP	-	-
	Profibus	OP	-	-
	LonWorks	OP	-	-
	Web server	HTML5	HTTP	HTTP
	FTP	-	•	•
	Expansion modules	Digital inputs/outputs	OP (8 + 8)	OP (8 + 8)
Digital inputs / Relay outputs		OP (8 + 8)	OP (8 + 8)	OP (8 + 8)
Analogue inputs/outputs		OP (4 + 8)	-	-
Standards	Measuring in accordance with IEC 61000-4-30	Accordinging Class A	Accordinging Class S	Class A
	UL	certificated	•	•
	Measuring in accordance with MID	•	•	•
Page		29	29	29
		OP - Optional		



NEW

CVM-A, Power quality analyzers, colour display, panel mounted

Power supply 85...265 Vac / 120...300 Vdc, 600 Vp-n / 1000 Vp-p measurement



Type	Code	Size(mm)	Energy accuracy	Current input	Transistor output	Output relay	Digital inputs	Commu- nications	Protocol
CVM-A1500-ITF-485-ICT2	[*] M56311.	144x144	0,2S (.../5A)	.../5A, .../1A, 250 mA	2	2	2	RS-485, Ethernet	Modbus/BACnet, webserver (HTTP), XML, HTML5

4-quadrant measuring unit with PowerStudio embedded. Built-in Datalogger module. Optional Modbus/TCP.
See expansion modules and accessories (Sealing gaskets) for CVM-A / CVM-B.
Energy accuracy for module... /5 A

QNA500, Advanced power quality analyzers (according Standard EN-50160 and IEC-61000-4-30)

agrupador

Type	Code	Energy accuracy	Class	Transis- tor output	Output relay	Digital inputs	Commu- nications	Protocol	Harmonics	Memory
Power quality kits										
K-QNA500	[*] Q20911.	0,2S	S	-	-	-	RS-232, RS-485, Ethernet	Modbus/TCP, ZMODEM, FTP	50	8 GB
K-QNA500 8IO	[*] Q20912.	0,2S	S	8	-	8	RS-232, RS-485, Ethernet	Modbus/TCP, ZMODEM, FTP	50	8 GB
K-QNA500 8IOR	[*] Q20913.	0,2S	S	-	8	8	RS-232, RS-485, Ethernet	Modbus/TCP, ZMODEM, FTP	50	8 GB
K-QNA500-A	[*] Q20931.	0,2S	A	-	-	-	RS-232, RS-485, Ethernet	Modbus/TCP, ZMODEM, FTP	50	8 GB
K-QNA500-A 8IO	[*] Q20932.	0,2S	A	8	-	8	RS-232, RS-485, Ethernet	Modbus/TCP, ZMODEM, FTP	50	8 GB
K-QNA500-A 8IOR	[*] Q20933.	0,2S	A	-	8	8	RS-232, RS-485, Ethernet	Modbus/TCP, ZMODEM, FTP	50	8 GB
Additional modules										
QNA-500	[*] Q20901.	0,2S	S	-	-	-	TCP/IP	-	-	8 GB
QNA500-A	[*] Q20921.	0,2S	A	-	-	-	TCP/IP	-	-	8 GB
IO8	[*] Q20902.	-	-	8	-	8	TCP/IP	-	-	8 GB
IO8R	[*] Q20903.	-	-	-	8	8	TCP/IP	-	-	8 GB

Communications through the BASE module (mandatory). Check the maximum number of modules that can be connected for each BASE system. The QNA500 include the Power Vision+ software
Each unit is made up of a BASE module (power supply) + measuring module + inputs/outputs module (according to each type). Compatible with PowerStudio (version 4.02 and higher).

CVM-A

Code	Internal code	↑	↑	↑	Delivery time
Power supply voltage	Standard (85...265 V _{ac} / 120...300 V _{dc})	0			-
	20...120 V _{dc}	F			1
Others	Metric fork terminals 3 - CAT III 300 V		B	T	-

QNA500

Code	Internal code	↑	Delivery time
current input	Standard (.../5 A)	0	-
	.../1 A	1	1

RS/TCP/CMBUS, Communication converters

Type	Code	Description
RS2RS	[*] M62141.	RS-232/485 Intelligent converter and amplifier (RTS control) for PC
USB-RS 485	[*] M54040.	USB to RS-485 Converter
USB-RS 232	[*] M54050.	USB to RS-232 Converter
TCP1RS+	[*] M62121.	RS-485 / Ethernet modbus/TCP Converter
TCP2RS+	[*] M54033.	RS-232/485 Converter / Ethernet Modbus/TCP. Built-in web server and web set-up
CMBUS-8	[*] M540A0.	M-Bus to Modbus Converter, up to 8 Mbus slaves
CMBUS-24	[*] M540B0.	M-Bus to Modbus Converter, up to 24 Mbus slaves

AIR, Wireless converters and probes

Type	Code	Description
air GATEWAY	[*] M62001.	Router RS485 Modbus/RTU to Radio
air BRIDGE	[*] M62002.	Radio Router to RS485 Modbus/RTU
air REPEATER	[*] M62003.	Signal repeater
air THL	[*] M62004.	Wireless temperature, relative humidity and brightness analyzer
air HANDZER	[*] M62005.	Portable wireless signal coverage analyzer
air TIDCI	[1] M62006.	2 NTC sensor + 2 S0 impulse counter

Modems, Communication accessories

Type	Code	Description
M-GSM 10 BITS	[*] Q30213IB00000	GSM RS-232/485 Modem (includes antenna + cable). Parameterisation with even parity (10 bits)
M-GSM 11 BITS	[*] Q30213EN00000	GSM RS-232/485 Modem (includes antenna + cable). Parameterisation with even parity (11 bits)
SGE-3G/GPRS	[*] Q30230.	GPRS-3G Modem with Ethernet communications (includes PS + antenna + cable)
ANTENA GSM UT-35 9db	[1] Q4994E.	Antenna 9 db (for GSM modem)

MC1, Triple scale single-phase efficient transformers

Type	Code	Measurement Range (A)	A (max.)	Class 0,5 Power (VA)	System	Usefull diam.(mm)
MC1-15-75	[*] M73112.	75	75	0,25	Single-phase	15
MC1-20-50/100/150 A	[*] M73118.	50/100/150	150	0,25	Single-phase	20
MC1-35-50/100/150 A	[*] M73116.	50/100/150	150	0,25	Single-phase	35
MC1-20-150/200/250 A	[*] M73113.	150/200/250	250	0,25	Single-phase	20
MC1-30-250/400/500 A	[*] M73114.	250/400/500	500	0,25	Single-phase	30
MC1-55-500/1000/1500 A	[*] M73115.	500/1000/1500	1500	0,25	Single-phase	55
MC1-80 1000/1500/2000 A	[*] M73117.	1000/1500/2000	2000	0,25	Single-phase	80

MC3, Three-phase current transformers

Type	Code	A (max.)	Class 0,5 Power (VA)	System	Usefull diam.(mm)
MC3 - 63 A	[*] M73121.	63	0,1	Three-phase	7,1
MC3 - 125 A	[*] M73122.	125	0,1	Three-phase	14,6
MC3 - 250 A	[*] M73123.	250	0,1	Three-phase	26

SC3, Split three-phase current transformers

Type	Code	A (max.)	Class 0,5 Power (VA)	System	Usefull diam.(mm)
SC3-125	[*] M73602.	125	0,1	Three-phase	15



PowerStudio, Energy management software

Type	Code	Description
Software SCADA		
PowerStudio	[*] M90211.	Software with USB HASP licence. Configuration, monitoring in real time, display of graphs and tables
PowerStudio-Scada	[*] M90231.	Software with USB HASP licence. Configuration, monitoring in real time, display of graphs and tables, generation of reports, creation of SCADA screens and alarms
PowerStudio-Deluxe	[C] M90241.	Software with USB HASP licence. Software PowerStudio-Scada with Generic Modbus driver used to connect to other devices available in the market
OPC Server PS/PSS	[1] M91111.	Software with USB HASP licence. OPC Sever for PowerStudio is an integration platform that can easily integrate the parameters received from PowerStudio (or any of its versions) in any SCADA platform available in the market with a simple approach.
SQL DATA EXPORT	[1] M91301.	Software with USB HASP licence. SQL Data Export for PS/PSS is a software tool for the integration of data from PS/PSS to a new or existing SQL database.

License 4.0 version 4.0

Dimensions

Wibeee

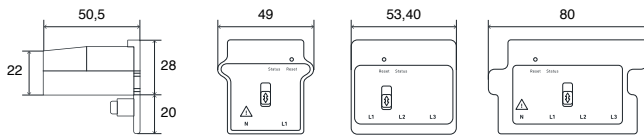

Wibeee Max

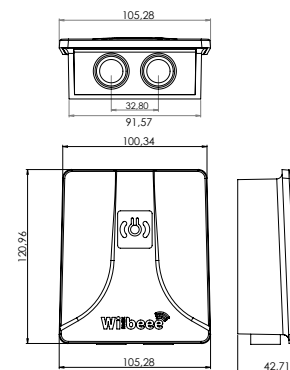

QNA 500

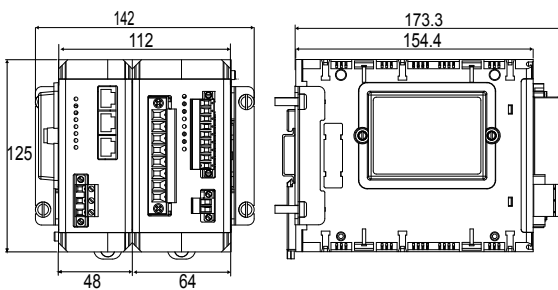

QNA 500 810

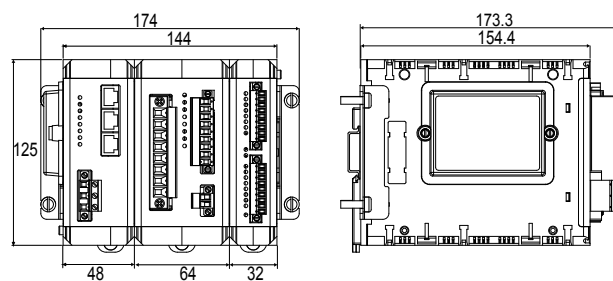

CVM A 1500

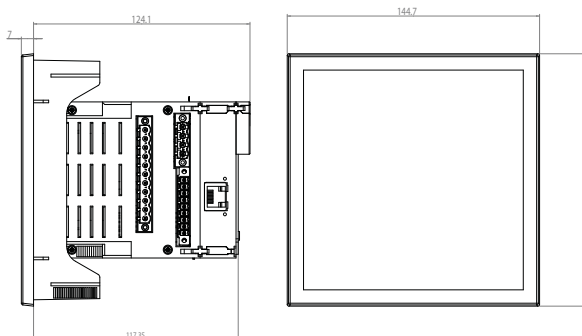

CVM B150

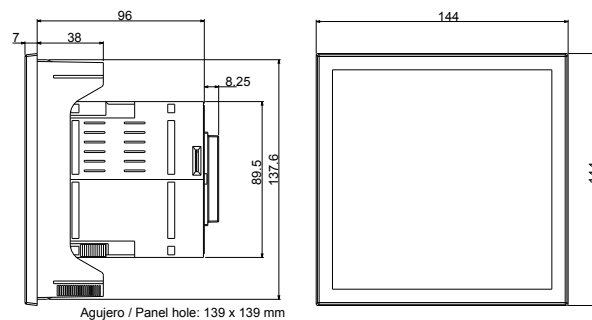

Dimensions

CVM B100

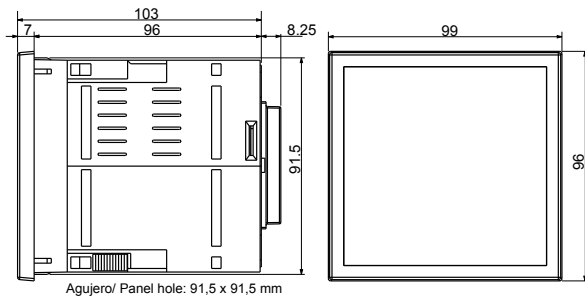

CVM C5 / CVM C10

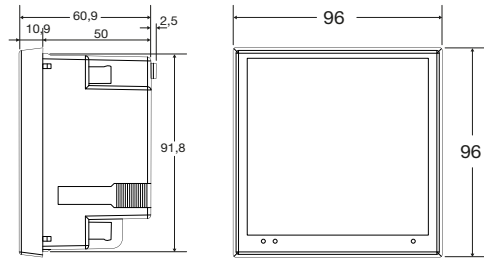

CVM MINI / CVM NET

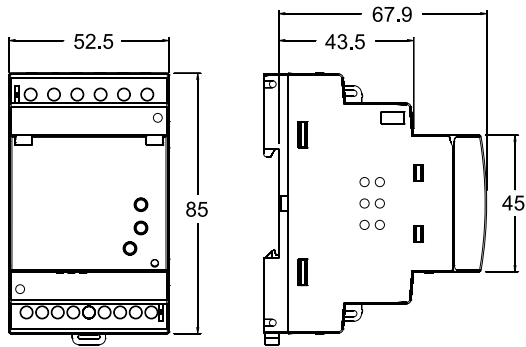

CVM NET4+

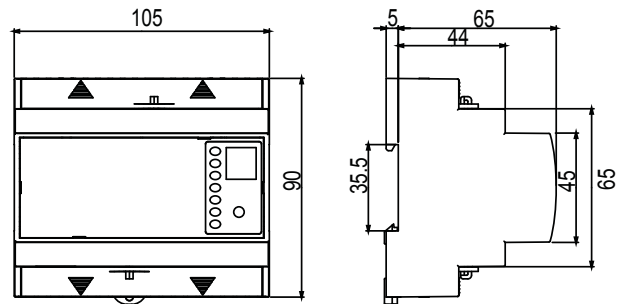

CEM-6

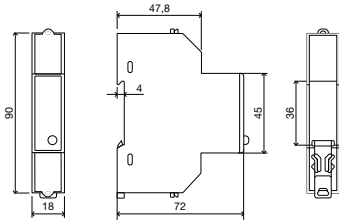

Measuring transformers and shunts

Table: Current transformers and shunts selection

		TC	TCH	TA	TP	STP	MC	TM 45	TRMC	TRM	SH
AC Measurement	For measuring instruments	•	•	•	•	•	•	•	-	•	•
	For billing meters	-	-	-	-	-	-	-	•	-	-
	Wound primary	-	-	T	-	-	-	•	T	-	-
	Passing bar	•	•	T	•	-	•	-	T	•	-
	Split-core	-	-	-	•	•	-	-	-	-	-
	Minimum range (A)	40	50	5	50	100	50	1	100	75	-
	Maximum range (A)	4000	4000	5000	6000	300	2000	50	2000	5000	-
	High accuracy	-	•	-	-	-	-	-	-	-	-
	Three-phase	-	-	-	-	-	T	-	T	-	-
DC measurement	Minimum range (A)	-	-	-	-	-	-	-	-	-	1
	Maximum range (A)	-	-	-	-	-	-	-	-	-	20000
Other parameters	Secondary output	.../5	.../5	.../5	.../5	.../1	...250 mA	.../5	.../5	.../5	.../60 mV
	in resin	OP	OP	-	-	-	-	-	•	•	-
	Sealable	OP	OP	OP	•	-	-	-	•	-	-
	UL Certificate	-	T	T	-	-	-	-	-	-	-
	Individual certificate	OP	OP	OP	OP	-	-	-	OP	OP	-
	Page	33	35	38	36	37	37	37	39	40	41

T - Depending on the type
OP - Optional

TC, Current transformers narrow section

Type	TC4	TC5	TC5.2
	width x height x depth (mm) 50x77x56	width x height x depth (mm) 58x77x59	
Flat strip(mm)	30 x 10 20 x 10 25 x 5	20 x 10 25 x 5 15 x 5	20 x 12 25 x 10 30 x 10
A/V-A	Class 0.5 1 3 Code	Class 0.5 1 3 Code	Class 0.5 1 3 Code
40/5		- - 1,5 [*] M70311.	
50/5	- - 1 [*] M703D5.	- - 3 [*] M70312.	
60/5	- - 1,25 [*] M703D6.	- 1,25 3,5 [*] M70313.	
75/5	- - 1,25 [*] M703D7.	- 2 3,5 [*] M70314.	
100/5	- 2 3 [*] M703D8.	1,5 2,5 3,75 [*] M70315.	- 1 1,5 [*] M70321.
125/5	- 2,5 3,75 [*] M703D9.	1,75 3,5 5 [*] M70316.	- 1,5 2 [*] M70322.
150/5	1,5 2,5 4 [*] M703DA.	2,5 3,5 5 [*] M70317.	1 2 2,5 [*] M70323.
200/5	2,5 5 6 [*] M703DB.	3,75 5 5 [*] M70318.	2,5 3 3,5 [*] M70324.
250/5		5 7,5 7,5 [*] M70319.	3,5 3,75 5 [*] M70325.
300/5			3,5 3,75 5 [*] M70326.
400/5			3,5 5 7,5 [*] M70327.
500/5			5 7,5 10 [*] M70328.
600/5			5 7,5 10 [*] M70329.

For other parameter coding, see table at the end of this section

Type	TC6.2	TC6	TC8.3
	width x height x depth (mm) 64x87.5x71	width x height x depth (mm) 64x87.5x71.2	width x height x depth (mm) 84.5x109x78
Flat strip(mm)	20 x 20 25 x 12 30 x 10	30 x 15 20 x 10 40 x 10	20 x 25 30 x 20 40 x 10
A/V-A	Class 0.5 1 3 Code	Class 0.5 1 3 Code	Class 0.5 1 3 Code
100/5	1,75 3,75 7,5 [*] M70341.		
125/5	3,75 7,5 10 [*] M70342.		
150/5	5 7,5 10 [*] M70343.	1 3,5 5 [*] M70331.	
200/5	7,5 10 10 [*] M70344.	3,5 5 7,5 [*] M70332.	10 15 25 [*] M703B2.
250/5	7,5 10 15 [*] M70345.	5 7,5 10 [*] M70333.	10 15 20 [*] M703B1.
300/5	10 10 15 [*] M70346.	5 7,5 10 [*] M70334.	15 20 25 [*] M703B3.
400/5	10 10 15 [*] M70347.	5 7,5 10 [*] M70335.	15 20 25 [*] M703B4.
500/5	15 15 20 [*] M70348.	7,5 10 15 [*] M70336.	15 20 25 [*] M703B5.
600/5	15 20 25 [*] M70349.	7,5 10 15 [*] M70337.	15 20 25 [*] M703B6.
750/5		10 15 20 [*] M70338.	20 25 30 [*] M703B7.
800/5		10 15 20 [*] M70339.	25 30 35 [*] M703B8.
1000/5			25 30 35 [*] M703B9.

Type	TC8	TC10	TC12
	width x height x depth (mm) 84.5x109x78	width x height x depth (mm) 108x137x78	width x height x depth (mm) 129x155x78
Flat strip(mm)	50 x 30 60 x 12	50 x 50 60 x 30 80 x 30	3 x 100 x 10
A/V-A	Class 0.5 1 3 Code	Class 0.5 1 3 Code	Class 0.5 1 3 Code
200/5	1 2,5 5 [*] M7036C.	1 2,5 5 [*] M7037F.	
300/5	2,5 5 7,5 [*] M7036B.	2,5 5 7,5 [*] M7037D.	
400/5	5 7,5 10 [*] M70361.	2,5 5 7,5 [*] M7037G.	
500/5	7,5 10 15 [*] M70362.	5 7,5 10 [*] M7037B.	
600/5	10 15 20 [*] M70363.	7,5 10 15 [*] M7037C.	
750/5	15 20 25 [*] M70364.	7,5 10 15 [*] M7037H.	
800/5	15 20 30 [*] M70365.	7,5 10 15 [*] M70372.	10 15 20 [*] M7038B.
1000/5	15 20 30 [*] M70366.	10 15 20 [*] M70373.	10 15 20 [*] M70381.
1200/5	15 20 30 [*] M70367.	10 15 20 [*] M70374.	10 15 20 [*] M70382.
1250/5	15 20 30 [*] M7036A.	10 15 20 [*] M7037E.	10 15 20 [*] M7038D.
1500/5	15 20 30 [*] M70368.	15 20 25 [*] M70375.	15 20 30 [*] M70383.
1600/5	15 20 30 [*] M70369.	15 20 25 [*] M70376.	15 20 30 [*] M70384.
2000/5		15 20 25 [*] M70377.	15 20 30 [*] M70385.
2500/5		15 20 30 [*] M70378.	20 30 40 [*] M70386.
3000/5		15 20 30 [*] M70379.	30 40 60 [*] M70387.
3200/5			30 40 60 [*] M7038C.
4000/5			35 40 60 [*] M70388.

TCH, Current transformers narrow section and high accuracy

Type	TCH6.2	TCH6	TCH8
	width x height x depth (mm) 74x87.15x71.12	width x height x depth (mm) 64x87.5x71.2	width x height x depth (mm) 84.1x114x83
Flat strip(mm)	30 x 10	40 x 10	60 x 12
A/V-A	Class 0.2 0.2S 0.5S Code	Class 0.2 0.2S 0.5S Code	Class 0.2 0.2S 0.5S Code
50/5	0,5 - - [*] M7044B.		
60/5	0,5 - - [*] M7044C.		
100/5	1,5 1 2,5 [*] M70441.		
125/5	1,5 1 2,5 [*] M70442.		
150/5	3,5 2,5 3,5 [*] M70443.	1,25 1 1,5 [*] M70431.	
200/5	5 3,5 5 [*] M70444.	1,5 1,25 2 [*] M70432.	
250/5	5 5 5 [*] M70445.	1,75 1,5 2,25 [*] M70433.	
300/5	5 5 5 [*] M70446.	2 1,75 2,5 [*] M70434.	
400/5	7,5 7,5 7,5 [*] M70447.	5 1 5 [*] M70435.	
500/5		7,5 5 7,5 [*] M70436.	
600/5		7,5 5 7,5 [*] M70437.	10 5 10 [*] M70463.
750/5		10 7,5 10 [*] M70438.	10 7,5 10 [*] M70464.
800/5		10 7,5 10 [*] M70439.	10 7,5 10 [*] M70465.
1000/5			15 10 15 [*] M70466.
1200/5			15 10 15 [*] M70467.
1250/5			15 10 15 [*] M7046A.
1500/5			15 10 15 [*] M70468.
1600/5			15 10 15 [*] M70469.

Type	TCH10	TCH12
	width x height x depth (mm) 108x137x78	width x height x depth (mm) 129x155x78
Flat strip(mm)	50 x 50 60 x 30 80 x 30	3 x 100 x 10
A/V-A	Class 0.2 0.2S 0.5S Code	Class 0.2 0.2S 0.5S Code
800/5	10 7,5 10 [*] M70472.	
1000/5	10 7,5 10 [*] M70473.	
1200/5	10 10 10 [*] M70474.	15 10 15 [*] M70482.
1250/5	10 10 10 [*] M7047C.	15 10 15 [*] M7048C.
1500/5	10 10 15 [*] M70475.	15 10 15 [*] M70483.
1600/5	10 10 15 [*] M70476.	15 10 15 [*] M70484.
2000/5	10 10 15 [*] M70477.	15 10 15 [*] M70485.
2500/5	10 10 15 [*] M70478.	20 15 20 [*] M70486.
3000/5	10 10 15 [*] M70479.	25 20 25 [*] M70487.
3200/5		25 20 25 [*] M7048B.
4000/5		30 25 30 [*] M70488.

For other parameter coding, see table at the end of this section - Other primary ratios consult

TP, Current transformers, split core

Type	TP-23	TP-58	TP-88
	width x height x depth (mm) 110x89x89	width x height x depth (mm) 145x114x114	width x height x depth (mm) 145x144x144
Flat strip(mm)	20 x 30	50 x 80	80 x 80
A/V-A	Class 0.5 1 3 Code	Class 0.5 1 3 Code	Class 0.5 1 3 Code
50/5	- - 1,5 [*] M7011A.		
75/5	- - 1,5 [*] M70117.		
100/5	- - 1,5 [*] M70111.	- - 2 [*] M7012D.	
125/5	- - 1,5 [*] M70118.		
150/5	- - 2 [*] M70112.	- - 3 [*] M7012A.	
200/5	- 1,5 2,5 [*] M70113.	- - 3 [*] M7012B.	
250/5	- 2 4 [*] M70114.	- 2 4 [*] M70121.	- 2 4 [*] M70131.
300/5	1,5 4 6 [*] M70115.	1,5 3 6 [*] M70122.	1,5 3 6 [*] M70132.
400/5	2,5 6 10 [*] M70116.	1,5 3 10 [*] M70123.	1,5 3 10 [*] M70133.
500/5		2,5 5 15 [*] M70124.	2,5 5 15 [*] M70134.
600/5		2,5 5 17,5 [*] M70125.	2,5 5 17,5 [*] M70135.
700/5		2,5 - - [3] M7012C.	
750/5		3 6 18 [*] M70126.	3 6 18 [*] M70136.
800/5		3 7 18 [*] M70127.	3 7 18 [*] M70137.
1000/5		5 10 20 [*] M70128.	5 10 20 [*] M70138.

Type	TP-812	TP-816
	width x height x depth (mm) 185x144x144	width x height x depth (mm) 245x184x184
Flat strip(mm)	80 x 120	80 x 160
A/V-A	Class 0.5 1 3 Code	Class 0.5 1 3 Code
500/5	- 4 12 [*] M70141.	3 - - [3] M7015F.
600/5	- 5 14 [*] M70142.	3 - - [3] M7015H.
750/5	2,5 6 17 [*] M70143.	5 - - [3] M70158.
800/5	3 7 18 [*] M70144.	
1000/5	5 9 20 [*] M70145.	10 15 20 [*] M70151.
1200/5	6 11 24 [*] M70146.	
1250/5	7 15 28 [*] M70147.	8 - - [3] M7015A.
1500/5	8 17 30 [*] M70148.	15 20 25 [*] M70152.
1600/5	8 17 30 [*] M70149.	8 - - [3] M7015B.
2000/5		15 20 25 [*] M70153.
2500/5	10 17 25 [*] M7014A.	15 20 25 [*] M70154.
3000/5		20 25 30 [*] M70155.
3200/5		20 - - [3] M7015C.
4000/5		20 25 30 [*] M70156.
5000/5		20 25 30 [*] M70157.
6000/5		20 - - [3] M7015E.

For other parameter coding, see table at the end of this section - Other primary ratios consult

STP, Current transformers, split core

Type	STP-24								
	width x height x depth (mm) 55x66x24								
Flat strip(mm)	24 mm								
Secondary	5A			1A			250mA		
A/V-A	Class	VA	Code	Class	VA	Code	Class	VA	Code
100	3	1	[C] M73323.	3	1	[C] M733230010000	3	0,1	[C] M7332300G0000
150	3	1	[C] M73325.	3	1	[C] M733250010000	3	0,1	[C] M7332500G0000
200	3	1	[C] M73326.	3	0,5	[C] M733260010000	3	0,1	[C] M7332600G0000
250	3	1	[C] M73327.	1	1	[C] M733270010000	1	0,1	[C] M7332700G0000
300	3	1	[C] M73328.	1	1	[C] M733280010000	1	0,1	[C] M7332800G0000



MC1, Triple scale single-phase efficient transformers

Type	Code	Measurement Range (A)	A (max.)	Class 0,5 Power (VA)	System	Usefull diam.(mm)
MC1-15-75	[*] M73112.	75	75	0,25	Single-phase	15
MC1-20-50/100/150 A	[*] M73118.	50/100/150	150	0,25	Single-phase	20
MC1-35-50/100/150 A	[*] M73116.	50/100/150	150	0,25	Single-phase	35
MC1-20-150/200/250 A	[*] M73113.	150/200/250	250	0,25	Single-phase	20
MC1-30-250/400/500 A	[*] M73114.	250/400/500	500	0,25	Single-phase	30
MC1-55-500/1000/1500 A	[*] M73115.	500/1000/1500	1500	0,25	Single-phase	55
MC1-80 1000/1500/2000 A	[*] M73117.	1000/1500/2000	2000	0,25	Single-phase	80



MC3, Three-phase current transformers

Type	Code	A (max.)	Class 0,5 Power (VA)	System	Usefull diam.(mm)
MC3 - 63 A	[*] M73121.	63	0,1	Three-phase	7,1
MC3 - 125 A	[*] M73122.	125	0,1	Three-phase	14,6
MC3 - 250 A	[*] M73123.	250	0,1	Three-phase	26



SC3, Split three-phase current transformers

Type	Code	A (max.)	Class 0,5 Power (VA)	System	Usefull diam.(mm)
SC3-125	[*] M73602.	125	0,1	Three-phase	15

TM45, Current transformers, winding primary, DIN rail

Type					
					
Flat strip(mm)	Winding primary				
A/V-A	Class				Code
	0.5	1	3		
1/5	2,5	5	7	[C] M70609.	
5/5	2,5	5	7	[*] M70601.	
10/5	2,5	5	7	[*] M70602.	
15/5	2,5	5	7	[*] M70603.	
20/5	2,5	5	7	[*] M70604.	
25/5	2,5	5	7	[*] M70605.	
30/5	2,5	5	7	[*] M70606.	
40/5	2,5	5	7	[*] M70607.	
50/5	2,5	5	7	[*] M70608.	



TC-420 / TP-420 / TCM / TCB, Current transformers with 4 ... 20 mA transducer check section Digital instruments and transducers

TA 210, Current transformers, winding primary

Type



A/V-A	Flat strip(mm)			Winding primary	
	Class			Code	
	0.5	1	3		
5/5	15	20	30	[*] M70541.	
10/5	15	20	30	[*] M70542.	
15/5	15	20	30	[*] M70543.	
20/5	15	20	30	[*] M70544.	
25/5	15	20	30	[*] M70545.	
30/5	15	20	30	[*] M70546.	
40/5	15	20	30	[*] M70547.	
50/5	15	20	30	[*] M70548.	
60/5	15	20	30	[*] M70549.	
75/5	15	20	30	[*] M7054A.	
80/5	15	20	30	[1] M7054K.	
100/5	15	20	30	[*] M7054B.	
125/5	15	20	30	[*] M7054C.	
150/5	15	20	30	[*] M7054D.	
200/5	15	20	30	[*] M7054E.	
250/5	15	20	30	[*] M7054F.	
300/5	15	20	30	[*] M7054G.	
400/5	15	20	30	[*] M7054H.	

TA, Current transformers, winding primary

Type	TA400				TA500				TA600			
	width x height x depth (mm)				width x height x depth (mm)				width x height x depth (mm)			
	95x165x59				115x185x63				124x192x62			
Flat strip(mm)	100 x 20				100 x 30				125 x 60			
A/V-A	Class				Class				Class			
	0.5	1	3	Code	0.5	1	3	Code	0.5	1	3	Code
300/5	5	10	15	[3] M7059A.								
400/5	5	10	15	[3] M70591.								
500/5	15	20	30	[3] M70592.								
600/5	15	20	30	[3] M70593.								
750/5	15	20	30	[*] M70594.								
800/5	15	20	30	[*] M70595.					15	15	-	[3] M705BB.
1000/5	15	20	30	[*] M70596.	15	20	30	[3] M705A2.	15	20	30	[*] M705B1.
1200/5	15	20	30	[*] M70597.	15	20	30	[3] M705A3.	15	20	30	[3] M705B2.
1500/5	15	30	40	[*] M70598.	15	30	40	[*] M705A4.	15	20	30	[*] M705B3.
2000/5	20	40	50	[*] M70599.	20	40	50	[*] M705A6.	15	20	30	[*] M705B5.
2500/5	20	40	50	[C] M7059B.	20	40	50	[*] M705A7.	20	30	40	[*] M705B6.
3000/5					20	45	60	[*] M705A8.	30	40	60	[*] M705B7.
3200/5									30	40	60	[3] M705BA.
4000/5					35	50	70	[*] M705A9.	30	50	70	[*] M705B8.
5000/5									40	60	80	[*] M705B9.

kit3-TRMC210, Sets of 3 current transformers for energy meters class 0,5S

Type	kit3-TRMC210			kit3-TRMC210-05			kit3-TRMC210-05S-2		
	width x height x depth (mm) 145x111x80								
A/V-A	Class	VA	Code	Class	VA	Code	Class	VA	Code
100/5	0.5S	10	[3] Q309010100000	0.5	10	[3] Q309610100000	0.5S	2,5	[3] Q309810100000
150/5	0.5S	10	[3] Q309020100000	0.5	10	[3] Q309620100000	0.5S	2,5	[3] Q309820100000
200/5	0.5S	10	[3] Q309030100000	0.5	10	[3] Q309630100000	0.5S	2,5	[3] Q309830100000
300/5	0.5S	10	[3] Q309040100000	0.5	10	[3] Q309640100000	0.5S	2,5	[3] Q309840100000
400/5	0.5S	10	[3] Q309050100000	0.5	10	[3] Q309650100000	0.5S	2,5	[3] Q309850100000
500/5	0.5S	10	[3] Q309060100000	0.5	10	[3] Q309660100000	0.5S	2,5	[3] Q309860100000
600/5	0.5S	10	[3] Q309070100000	0.5	10	[3] Q309670100000	0.5S	2,5	[3] Q309870100000

kit3-TRMC400, Sets of 3 current transformers for energy meters class 0,5S

Type	kit3-TRMC400			kit3-TRMC400-05			kit3-TRMC400-05-2		
	width x height x depth (mm) 99x160x68								
Flat strip(mm)	100x20 mm								
A/V-A	Class	VA	Code	Class	VA	Code	Class	VA	Code
750/5	0.5S	10	[3] Q309110100000	0.5	10	[3] Q309710100000	0.5	2,5	[3] Q309A10100000
1000/5	0.5S	10	[3] Q309120100000	0.5	10	[3] Q309720100000	0.5	2,5	[3] Q309A20100000
1500/5	0.5S	10	[3] Q309130100000	0.5	10	[3] Q309730100000	0.5	2,5	[3] Q309A30100000
2000/5	0.5S	10	[3] Q309140100000	0.5	10	[3] Q309740100000	0.5	2,5	[3] Q309A40100000
3000/5							0.5	2,5	[3] Q309A60100000

**TRMCx3, Current transformers for energy meters**

Type	Code	Measurement Range (A)	Class 0,5S	Power (VA)	Usefull diam.(mm)	Cable (m)
Indoor						
TRMC-x3 100/5	[*] Q301T1.	100/5		2,5	38	1.5
TRMC-x3 200/5	[*] Q301T2.	200/5		2,5	38	1.5
TRMC-x3 300/5	[*] Q301T3.	300/5		2,5	38	1.5
TRMC-x3 400/5	[*] Q301T4.	400/5		2,5	38	1.5
Outdoor						
TRMC-X3 100/5 Ext	[C] Q301T1010E000	100/5		2,5	38	7
TRMC-X3 200/5 Ext	[C] Q301T2010E000	200/5		2,5	38	7
TRMC-X3 300/5-ext	[C] Q301T3010E000	400/5		2,5	38	7
TRMC-X3 400/5 Ext	[C] Q301T4010E000	300/5		2,5	38	7



TRM, Measuring transformers encapsulated in resin

Type	TRM30			TRM40			TRM60		
	width x height x depth (mm) 110x147x50			width x height x depth (mm) 135x168x38			width x height x depth (mm) 135x178x36		
Flat strip(mm)	30 mm			40 mm			60 mm		
A/V-A	Class	VA	Code	Class	VA	Code	Class	VA	Code
75/5	1	2	[4] P50101.						
100/5	1	5	[4] P50102.						
150/5	1	5	[4] P50103.	0.5	5	[4] P50111.			
200/5	0.5	10	[4] P50104.	0.5	7,5	[4] P50112.			
250/5	0.5	15	[4] P50105.	0.5	10	[4] P50113.	0.5	5	[4] P50121.
300/5	0.5	20	[4] P50106.	0.5	15	[4] P50114.	0.5	7,5	[4] P50122.
400/5	0.5	25	[4] P50107.	0.5	20	[4] P50115.	0.5	10	[4] P50123.
500/5				0.5	25	[4] P50116.	0.5	15	[4] P50124.
600/5				0.5	30	[4] P50117.	0.5	20	[4] P50125.
800/5				0.5	35	[4] P50118.	0.5	25	[4] P50126.
1000/5							0.5	30	[4] P50127.
1200/5							0.5	35	[4] P50128.

Type	TRM80			TRM100		
	width x height x depth (mm) 135x178x36			width x height x depth (mm) 175x228x38		
Flat strip(mm)	80 mm			100 mm		
A/V-A	Class	VA	Code	Class	VA	Code
500/5	0.5	5	[4] P50131.			
600/5	0.5	7,5	[4] P50132.			
750/5	0.5	10	[4] P50133.	0.5	15	[4] P50141.
1000/5	0.5	15	[4] P50134.	0.5	20	[4] P50142.
1500/5	0.5	20	[4] P50135.	0.5	20	[4] P50144.
2000/5	0.5	25	[4] P50136.	0.5	20	[4] P50145.
2500/5	0.5	30	[4] P50137.	0.5	20	[4] P50146.
3000/5				0.5	25	[4] P50147.

Type	TRM140				TRM180			
	width x height x depth (mm) 223x269x40				width x height x depth (mm) 223x306x40			
Flat strip(mm)	140 mm				180 mm			
A/V-A	Class	VA	Code	EUR	Class	VA	Code	EUR
1000/5	0.5	15	[4] P50151.					
1250/5	0.5	20	[4] P50152.		0.5	15	[4] P50161.	
1500/5	0.5	25	[4] P50153.		0.5	20	[4] P50162.	
2000/5	0.5	30	[4] P50154.		0.5	20	[4] P50163.	
2500/5	0.5	35	[4] P50155.		0.5	20	[4] P50164.	
3000/5	0.5	35	[4] P50156.		0.5	20	[4] P50165.	
4000/5	0.5	35	[4] P50157.		0.5	20	[4] P50166.	
5000/5					0.5	20	[4] P50167.	

SH, Shunts

Type	SHP		SHB		SH	
						
Accuracy	1		0.5			
Relation	Type	Code	Type	Code	Type	Code
1A/60mV			SHB 1A/60mV	[3] M71221.		
1.5A/60mV			SHB 1.5A/60mV	[3] M71222.		
2.5A/60mV			SHB 2.5A/60mV	[3] M71223.		
4A/60mV			SHB 4A/60mV	[3] M71224.		
5A/60mV			SHB 5A/60mV	[3] M71225.		
6A/60mV			SHB 6A/60mV	[3] M71226.		
10A/60mV			SHB 10A/60mV	[*] M71227.		
15A/60mV			SHB 15A/60mV	[*] M71228.		
25A/60mV			SHB 25A/60mV	[*] M71229.		
30A/60mV	SHP 30A/60mV	[3] M71211.	SHB 30A/60mV	[*] M7122A.	SH 30A/60mV	[*] M71231.
40A/60mV	SHP 40A/60mV	[3] M71212.	SHB 40A/60mV	[*] M7122B.	SH 40A/60mV	[2] M71232.
50A/60mV	SHP 50A/60mV	[3] M71213.	SHB 50A/60mV	[*] M7122C.	SH 50A/60mV	[*] M71233.
60A/60mV	SHP 60A/60mV	[3] M71214.	SHB 60A/60mV	[*] M7122D.	SH 60A/60mV	[*] M71234.
75A/60mV	SHP 75A/60mV	[3] M71215.				
80A/60mV			SHB 80A/60mV	[*] M7122E.	SH 80A/60mV	[*] M71235.
100A/60mV	SHP 100A/60mV	[3] M71216.	SHB 100A/60mV	[*] M7122F.	SH 100A/60mV	[*] M71236.
150A/60mV	SHP 150A/60mV	[3] M71217.			SH 150A/60mV	[*] M71237.
200A/60mV	SHP 200A/60mV	[3] M71218.	SHB 200A/60mV	[2] M7122N.	SH 200A/60mV	[*] M71238.
250A/60mV					SH 250A/60mV	[*] M71239.
300A/60mV					SH 300A/60mV	[*] M7123A.
400A/60mV					SH 400A/60mV	[*] M7123B.
500A/60mV					SH 500A/60mV	[*] M7123C.
600A/60mV					SH 600A/60mV	[*] M7123D.
750A/60mV					SH 750A/60mV	[2] M7123E.
800A/60mV					SH 800A/60mV	[2] M7123F.
1000A/60mV					SH 1000A/60mV	[*] M7123G.
1200A/60mV					SH 1200A/60mV	[3] M7123H.
1500A/60mV					SH 1500A/60mV	[*] M7123J.
2000A/60mV					SH 2000A/60mV	[3] M7123K.
2500A/60mV					SH 2500A/60mV	[3] M7123L.
3000A/60mV					SH 3000A/60mV	[3] M7123M.
4000A/60mV					SH 4000A/60mV	[3] M7123N.
5000A/60mV					SH 5000A/60mV	[3] M7123P.
6000A/60mV					SH 6000A/60mV	[3] M7123Q.
7500A/60mV					SH 7500A/60mV	[3] M7123R.
8000A/60mV					SH 8000A/60mV	[C] M7123S.
10000A/60mV					SH 10000A/60mV	[C] M7123T.
12500A/60mV					SH 12500A/60mV	[C] M7123U.
15000A/60mV					SH 15000A/60mV	[C] M7123V.
18000A/60mV					SH 18000A/60mV	[C] M7123Z.
20000A/60mV					SH 20000A/60mV	[C] M7123O.

Insulating base socket for type SHB (up to 100 A) All shunts are supplied with 1.5 m long cables with a 1.5 m² cross-section

FOR OTHER PARAMETER CODING see table at the end of below

VT, Measurement voltage transformers

Type	Code	Class 0,5 Power (VA)	Class 1 Power (VA)	Relation
VT2311 230V/110V	[3] M72311.	10	25	230/110V
VT3823 380V/230V	[3] M72352.	10	25	380/230V
VT4011 400V/110V	[3] M72321.	10	25	400/110V
VT4023 400V/230V	[3] M72322.	10	25	400/230V
VT4411 440V/110V	[3] M72331.	10	25	440/110V
VT4423 440V/230V	[3] M72332.	10	25	440/230V
VT4811 480V/110V	[3] M72341.	10	25	480/110V
VT4823 480V/230V	[3] M72342.	10	25	480/230V
VT7023 700V/110V	[3] M72381.	10	25	700/110V
VT7023 700V/230V	[3] M72382.	10	25	700/230V

TSR, Current adding transformer

Type	Code	Current	Class 0,5 Power (VA)	Class 1 Power (VA)	Measuring Channels
Current adding transformers fixed on a DIN rail					
TSR-2	[*] M70701.	5A	15	30	2
TSR-3	[*] M70702.	5A	15	30	3
TSR-4	[*] M70703.	5A	15	30	4
TSR-5	[*] M70704.	5A	15	30	5

TE, Impedance elevator transformer

Type	Code	Class 1 Power (VA)	Relation
TE-5/0.1	[*] M70911.	15	5 /0,1 A

FOR OTHER PARAMETER CODING see table at the end of below



For Protection current transformers SEE SECTION Protection and Control/Protection current transformers

CODIFICATION TABLE

TC, TP, TA, TCH, TM45, TSR

Code	Internal code	Delivery time
M 7 X X X X 0 0 X X		
Secondary	Standard (.../ 5 A)	0
	.../ 1 A(*)	1
Certificate	-	0
	Individual (**)	1

(*) Not available in TC4 type

(**) A certificate is attached for every transformer

TRM

Code	Internal code	Delivery time
P 5 X X X X 0 0 X		
Secundario	Estándar (.../ 5 A)	0
	.../ 1 A	1

SH, SHB

Code	Internal code	Delivery time
M 7 X X X X 0 0 X		
Input	Standard .../60 mV	0
	.../50 mV	1
	.../75 mV	7
	.../100 mV	2
	.../150 mV	3
	.../200 mV	4
	.../250 mV	8
	.../300 mV	5
	.../400 mV	9
	.../600 mV	6

Dimensions

TC / TCH

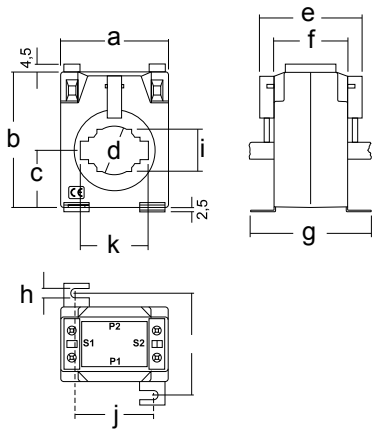

Dimensions (mm)	TC 4	TC 5 TCH 5	TC 5.2 TCH 5.2	TC 6.2 TCH 6.2	TC 6 TCH 6	TC 8 TCH 8	TC 10 TCH 10
a	50	58	58	64	64	84,5	108
b	70	70	70	80,5	80,5	102	130
c	29	29	29	34	34	46	61
d	21	20,3	22	26	28,5	44	63
e	43,5	45	45	60,5	66,5	69	---
f	30	32	32	44	44	50	50
g	56	59	59	71	71,2	78	78
h	5,5	5,6	5,6	5,6	5,6	6,6	6,6
i	45,5	48	48	60	60	64	64
j	31,6	39	39	46	46	62	86
k	30,5	25,6	30,6	20,6	40,6	60,6	80,6
l	30,5	15,6	15,6	30,6	25,2	30,6	50,8

TC 12

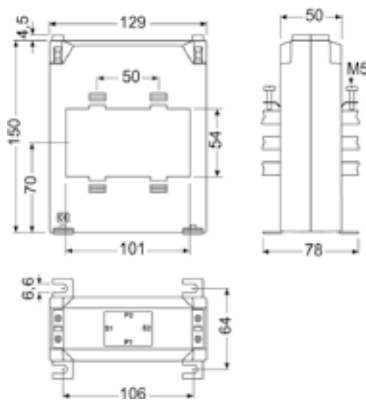

TP

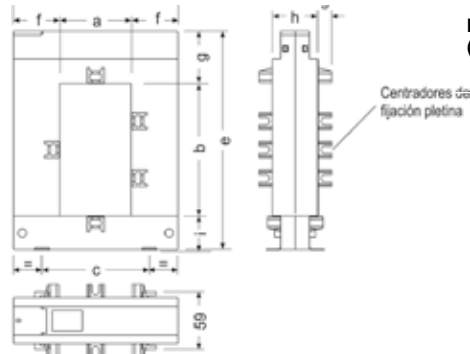

Dimensions (mm)	TP-23	TP-58	TP-88	TP-812	TP-816
a	20	50	80	80	80
b	30	80	80	120	160
c	51	78	108	108	120
d	89	114	144	144	184
e	110	145	145	185	245
f	34	32	32	32	52
g	47	32	32	32	47
h	40	32	32	32	52
i	32	32	32	32	38

Note: All types have fixing centering units, except for TP-23

TA 400

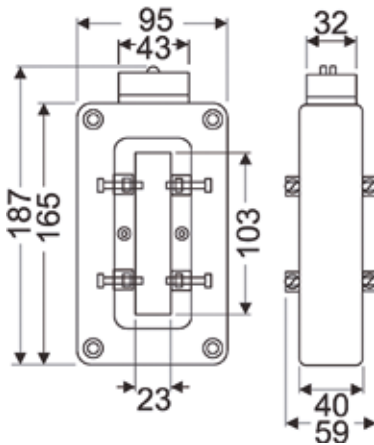

TA 500

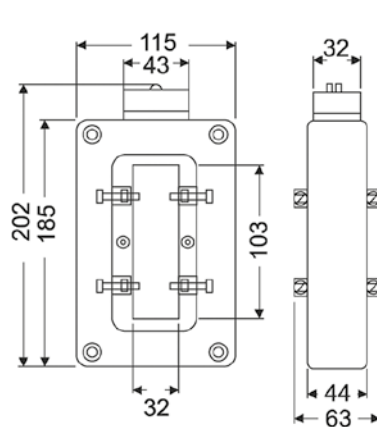

TA 600

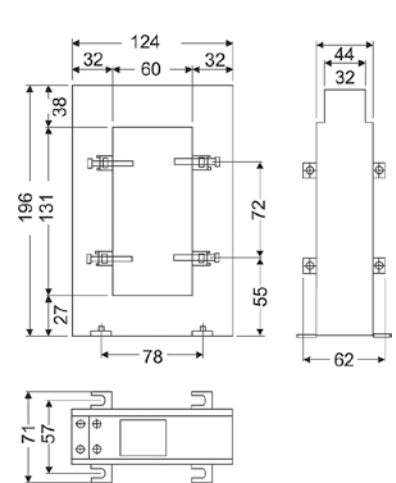

TA 210

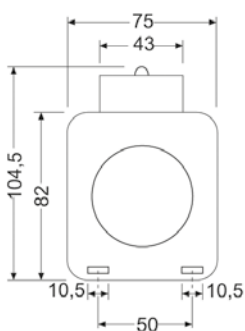

TM 45

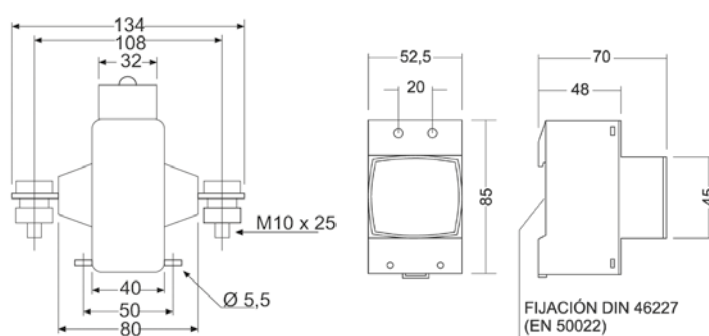

Dimensions

MC1

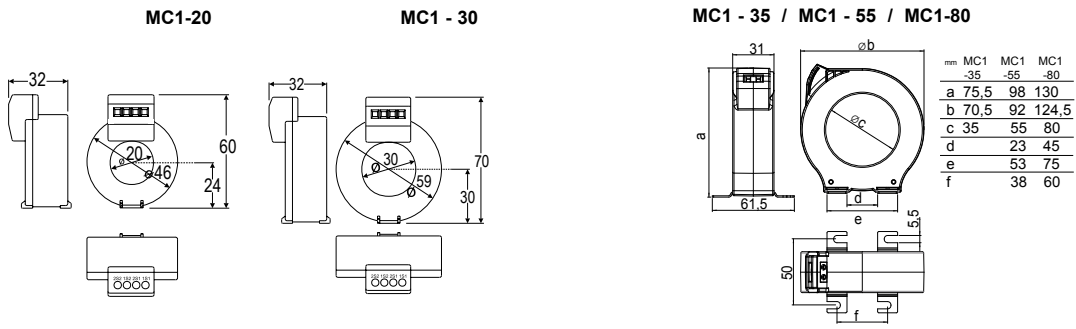

MC3

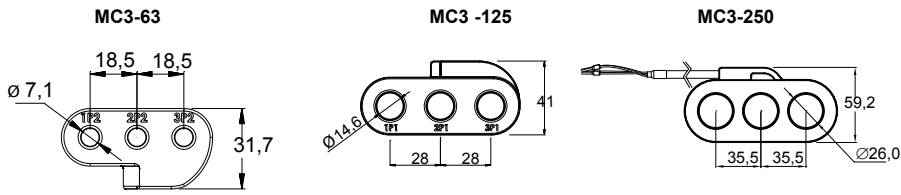

STP-24

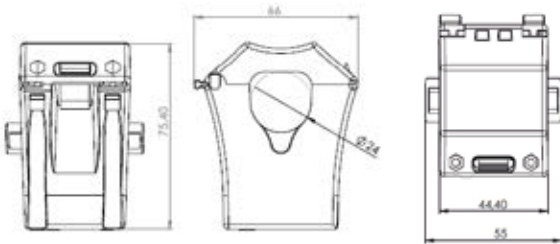

TRMCx3

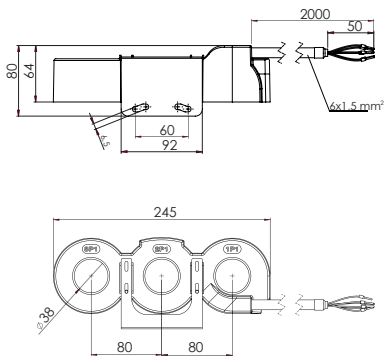

Control devices

		Page
Energy manager	EDS	45
Maximum demand control device	MDC-20	46
	MDC-4	46
Impulse and contact centralisers	LM	45
Public lighting control system	CIR-LAMP	46
Communication accessories	Cable communication converters	46
	Wireless converters and probes	47
	Modems	47



EDS, Energy manager with powerStudio and built-in web server

Type	Code	Output relay	Digital inputs	Communications	Protocol
EDS	[*] M61010.	6	8	Ethernet	Modbus Circutor
EDS -Deluxe	[*] M61020.	6	8	Ethernet	Modbus / XML
With 3G communications					
EDS-3G	[*] M61012.	6	8	Ethernet /3G	Modbus Circutor
EDS-3G_Deluxe	[C] M61022.	6	8	Ethernet /3G	Modbus / XML

Type	Code	Description
Accessories antennas		
GXS2	[*] M610A1.	Antenna 4 GHz, 2,14 dBi + cable 5 m
GC2	[*] M610A2.	Antenna 4 GHz, 2,2 dBi antibanda

EDS application example

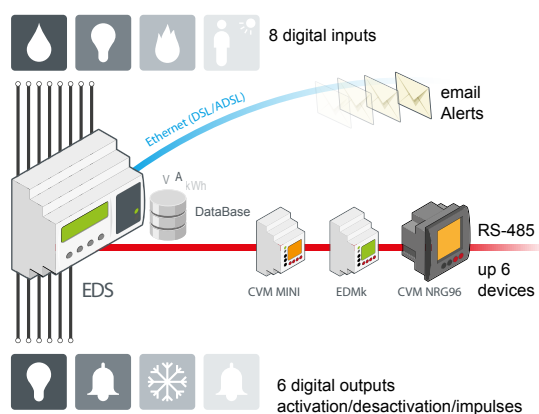

EDS-3G application example

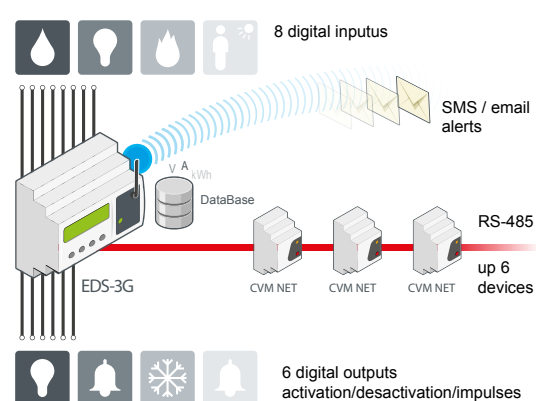

LM, Impulse and contact centralisers

Type	Code	Modules	Output relay	Digital inputs	Analogue Inp.	Communications	Protocol
LM50-TCP+	[*] M31566.	8	-	50	-	RS-485	TCP y UDP, Modbus/TCP
LM25-M	[*] M31567.	8	-	25	-	RS-485	Modbus/RTU
LM4I-4O-M	[*] M31563.	4	4	4	-	RS-485	Modbus/RTU
LM4A-2IO-M	[*] M31565.	4	2	2	4 (4...20mA)	RS-485	Modbus/RTU

(*) Digital inputs (logic 0 / 1) or energy impulses



MDC, Maximum demand control devices

agrupador		
Type	Code	Description
MDC-20, 6 local Loads, expandable, predictive control		
MDC-20	[*] M61410.	8 digital inputs for logical states or counting impulse signals (electric energy meters, water meters, gas meters, etc.). Load status feedback (inputs/outputs). Expandable via auxiliary LM range units. Historical records of over one year with a log of up to 4500 electrical variables, averaged every 15 minutes, maximum and minimum values over the period (Period can be modified. Ring buffer). RS-485 BUS for connecting up to 12 LM4 i/o
MDC-4	[*] M61430.	Maximum demand control unit, by level. Includes a built-in three-phase power analyzer and 4 relay outputs of up to 6 A for controlling non-priority loads

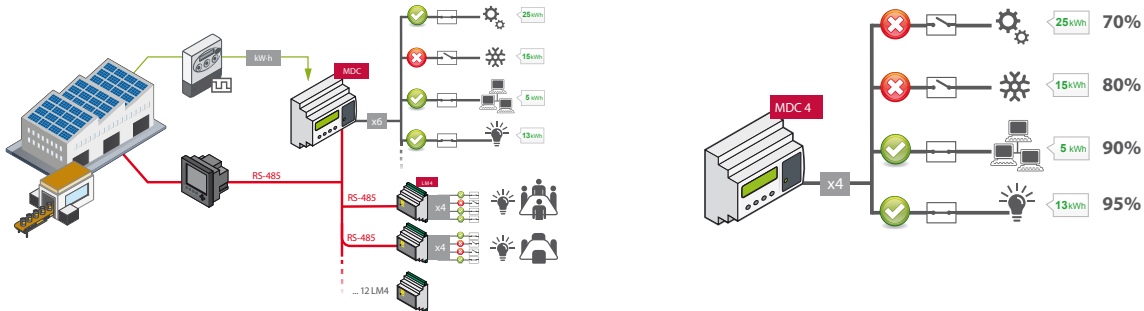
CirLAMP, Public lighting control system

Type	Code	Description
CIRLAMP manager, master device to manage the light control devices (CIRLAMP nodo)		
CIRLAMP Manager	[*] M63001.	CIRLAMP has a configuration Web site, where the user can fully configure the configuration parameters of each light point. In addition, the device has an XML server, so that it can be integrated in any global control and maintenance platform
CirLAMP 8I8O	[C] M63002.	Input/Output module
CIRLAMP Nodos		
CIRLAMP NODO DN	[C] M63021.	For managing the lights with 2-level electronic ballasts / drivers (lamp power of up to 600 W)
CIRLAMP NODO 1...10	[C] M63011.	For managing the lights with electronic ballasts / drivers with 1...10V regulation (lamp power of up to 600 W)
CIRLAMP nodo DALI	[C] M63030.	For managing the lights with electronic ballasts/drivers with DALI protocol (lamp power of up to 600 W)

B-band PLC Communications in compliance with CENELEC regulations, with a DCSK system. Detection of operating errors in the light for maintenance purposes: Blown lamp, Flashing lamp, Open capacitor, Number of operating hours of the lamp.

TH-DG, Photovoltaic monitoring

Type	Code	Description
TH-DG-RS485	[*] M61310.	Temperature and humidity probe with RS-485 communications (Modbus/RTU).. Needs a 9...24 V ac/cc power supply. PowerStudio supported

ReadWatt, Impulse collection with communication

Type	Code	Description
ReadWatt	[*] M62311.	Impulse collector with RS232/RS485 Modbus communications. Built in transistor output. PowerStudio supported
PS 100...240Vcc	[*] M62331.	ReadWatt power supply

RS/TCP/CMBUS, Communication converters

Type	Code	Description
RS2RS	[*] M62141.	RS-232/485 Intelligent converter and amplifier (RTS control) for PC
USB-RS 485	[*] M54040.	USB to RS-485 Converter
USB-RS 232	[*] M54050.	USB to RS-232 Converter
TCP1RS+	[*] M62121.	RS-485 / Ethernet modbus/TCP Converter
TCP2RS+	[*] M54033.	RS-232/485 Converter / Ethernet Modbus/TCP. Built-in web server and web set-up
CMBUS-8	[*] M540A0.	M-Bus to Modbus Converter, up to 8 Mbus slaves
CMBUS-24	[*] M540B0.	M-Bus to Modbus Converter, up to 24 Mbus slaves



AIR, Wireless converters and probes

Type	Code	Description
air GATEWAY	[*] M62001.	Router RS485 Modbus/RTU to Radio
air BRIDGE	[*] M62002.	Radio Router to RS485 Modbus/RTU
air REPEATER	[*] M62003.	Signal repeater
air THL	[*] M62004.	Wireless temperature, relative humidity and brightness analyzer
air HANDZER	[*] M62005.	Portable wireless signal coverage analyzer
air TIDCI	[1] M62006.	2 NTC sensor + 2 S0 impulse counter

Modems, Communication accessories

Type	Code	Description
M-GSM 10 BITS	[*] Q30213IB00000	GSM RS-232/485 Modem (includes antenna + cable). Parameterisation with even parity (10 bits)
M-GSM 11 BITS	[*] Q30213EN00000	GSM RS-232/485 Modem (includes antenna + cable). Parameterisation with even parity (11 bits)
SGE-3G/GPRS	[*] Q30230.	GPRS-3G Modem with Ethernet communications (includes PS + antenna + cable)
ANTENA GSM UT-35 9db	[1] Q4994E.	Antenna 9 db (for GSM modem)

Dimensions

EDS / MDC-4 / MDC-20

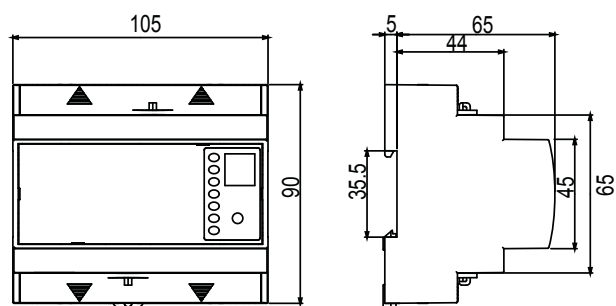

LM50-TCP

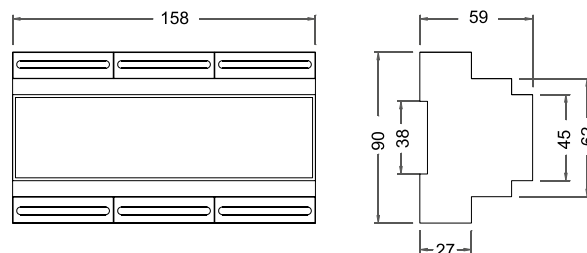

LM25-M

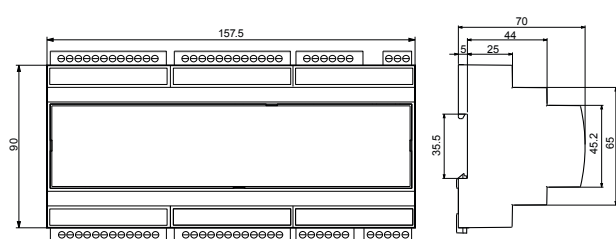

LM41/40-M / LM4A-210

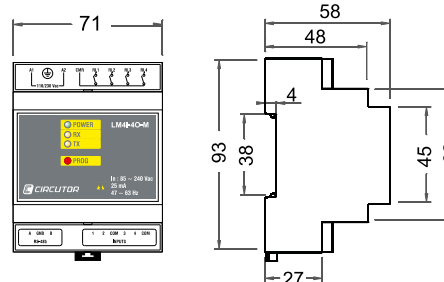

CIRLAMP Manager

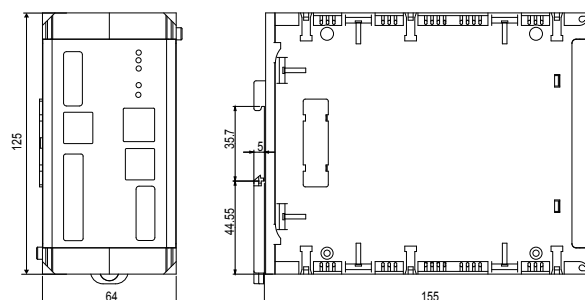

Management Software



PowerVision/CIR-ENERGY, Energy management software

Type	Code	Description
Data management software		
PowerVisionPlus	[*] M90413.	Software for reading, downloading and processing files for devices equipped with memories (depending on type). Elaboration of graphs and tables from information. Automatic downloading for QNA Power Quality Analyzers. Other related units: AR5, AR5-L, QNA, CLP, CVM-BD M, CIR-E3 and AR6 series



PowerStudio, Energy management software

Type	Code	Description
Software SCADA		
PowerStudio	[*] M90211.	Energy supervision software for buildings and industrial installations, with the possibility of viewing reports, layouts and single-line diagrams. Other functions include: <ul style="list-style-type: none"> • Remote parameterisation of the units • Real-time display of parameters • Recording and printout of logs in table or graphic format • Multi-station Web Server and integrated XML Server • Creation of access users and profiles for the application with user name and password • Great versatility and very simple use • Compatible with OPC software for PS/PSS • Custom event configuration (Alarms, Calculations, Sending Emails) • Construction of customised screens • Possibility of performing control actions on the units • Report generator and energy bill simulator module, Possibility to emulate tariffs or time periods • Parameterisation of custom calculations to obtain EnPIs • Comparison of historical data stored in the system • Management of multi-point remote systems in combination with EDS and EDS-3G data servers • Compatible with the 32 and 64-bit Windows 7 and 8 platforms
PowerStudio-Scada	[*] M90231.	Energy monitoring software for industrial buildings and installations. It allows each installation to be controlled, providing the power line status in real time and first-hand, as well as the general consumption of the installation both at low and medium voltage. Its main features are: <ul style="list-style-type: none"> • Configuring CIRCUTOR units connected to the communications network • Displaying the parameters from the measuring units installed on site in real time • Creating databases • Recording and searching the historical data stored on a computer in graphical or table format • Built-in XML server • Exporting to text files and spreadsheets • Access to information through a conventional Internet browser
PowerStudio-Deluxe	[C] M90241.	In addition to the performance features offered by the standard module, Power Studio Scada, Deluxe can: <ul style="list-style-type: none"> • Generic Modbus driver used to connect to other devices available in the market • RS485 with Modbus/RTU protocol (driver composition). • Transparent Ethernet connections with the UDP, TCP and Modbus/TCP protocols • Variables to be integrated must have a hexadecimal format. • Acquisition of data with the OPC/DA protocol (real-time data). • Connection and display of video surveillance cameras with an IP connection (no recording functions). • Connection of PSSDs in cascade. • Generic driver used to download meters with the IEC 870 protocol (standard ASDUS) • Global integration of remote PowerStudio applications in a single server • Compatible with 64-bit Windows platforms • Compatible with OPC software for PS/PSS
OPC Server PS/PSS	[1] M91111.	OPC Server for PowerStudio is an integration platform that can easily integrate the parameters received from PowerStudio (or any of its versions) in any SCADA platform available in the market with a simple approach. The format of requests that can be integrated will be DA real time data. It includes the Tunnelling function, establishing OPC connections over IP through a corporate network. In addition, it can establish decentralised or remote connections (routing). Therefore, any SCADA platform available in the market with an OPC/DA client function can immediately integrate all parameters received from the CIRCUTOR platform
SQL DATA EXPORT	[1] M91301.	SQL Data Export for PS/PSS is a software tool for the integration of data from PS/PSS to a new or existing SQL database. Main advantages of SQL Data Export: <ul style="list-style-type: none"> • Exporting historic data stored in SQL databases • Optional selection of devices or databases to be exported • Programming the download frequency • Multiple architectures

License 4.0 version 4.0

Databox, Energy management software

Type	Description
DataBox	Software with licence in the cloud (Databox cloud platform) for complete management of all parameters required for the optimum performance of Energy Audits. The Databox system combines data recording, display and operation from any location using any PC, smartphone or tablet.

SBOX, Gateway for DataBox platform





Type	Code	Description
SBOX 3G VPN	[*] M61920.	Gateway with 3G communications via VPN network (1) and SIM card fully configured to send data from the units connected to the RS-485 port or Ethernet to the Databox cloud platform in order to carry out energy audits and improvements related to electrical energy efficiency
SBOX 3G NET	[*] M61930.	Gateway with 3G communications (SIM card must be provided by the user) to send data from the units connected to the RS-485 port or Ethernet to the Databox cloud platform in order to carry out energy audits and improvements related to Electrical Energy Efficiency

Delivery time: [*] immediate
 [x] working weeks
 [c] consult



Portable power analyzers

Table: Portable power analyzers

		MYeBOX 1500	MYeBOX 150	CIR-e+	CAVA	VLOG-10
						
Connection	single-phase	•	•	–	•	•
	Three-phase	•	•	•	–	–
Parameters	Voltage	•	•	•	•	•
	Current	•	•	•	T	–
	Neutral current	•	•	–	–	–
	Leakage current	•	–	–	–	–
	Neutral-earth voltage	•	–	–	•	–
	Power	•	•	•	T	–
	Energy (active and reactive)	•	•	•	T	–
	Harmonics	•	•	•	T	–
	Flicker	•	•	•	–	–
	Quality parameter measurements	Events (overvoltages, gaps and interruptions)	•	•	•	•
EN50160 parameters		•	•	•	–	–
Transients		•	•	–	–	–
Inputs/outputs	Digital inputs	2	–	–	–	–
	Digital outputs	2	–	–	–	–
Other features	Memory	•	•	•	•	•
	Communications	WiFi 3G µUSB	WiFi µUSB	USB / SD CARD	–	USB
	Display	LCD	LCD	–	–	–
	Display of parameters	Display Smartphone & tablet (APP) Software	Display Smartphone & tablet (APP) Software	Display Software	Display Software	Software
	Display of files	Smartphone & tablet (APP) Software	Smartphone & tablet (APP) Software	Display Software	Display Software	Software
Standards	Measuring in accordance with IEC 61000-4-30	Class A (*)	Class S(*)	Class B	Class B	Class B
	Measuring in accordance with UL	• (certified)	• (certified)	–	–	–
	Page	50	50	51	52	52
	T - Depending on Type (*) See manual					

MYeBOX, Portable power analyzer with recording of quality events and transients in accordance with (IEC 61000-4-30 Ed.2) Class A

Type	Code	Clamp	Measuring Channels	Transistor output	Digital inputs	Communications
kit MYeBOX-150	[*] M84023.	-	4	-	-	WiFi
kit MYeBOX-1500	[*] M84033.	-	5	2	2	WiFi + 3G
Portable analyzer kits with current sensors						
MYeBOX150+3 FLEX-R45	[*] M8404B.	3 FLEX-R45	4	-	-	WiFi
MYeBOX1500+3 FLEX-R45	[*] M8405B.	3 FLEX-R45	5	2	2	WiFi + 3G
MYeBOX-150-4 FLEX-R45	[*] M8404C.	4 FLEX-R45	4	-	-	WiFi
MYeBOX-1500-4 FLEX-R45	[*] M8405C.	4 FLEX-R45	5	2	2	WiFi + 3G
MYeBOX-150-3 FLEX-R80	[*] M8404D.	3 FLEX-R80	4	-	-	WiFi
MYeBOX 1500+3 FLEX-R80	[*] M8405D.	3 FLEX-R80	5	2	2	WiFi + 3G
MYeBOX-150-4 FLEX-R80	[*] M8404E.	4 FLEX-R80	4	-	-	WiFi
MYeBOX-1500-4 FLEX-R80	[*] M8405E.	4 FLEX-R80	5	2	2	WiFi + 3G
MYeBOX150 + 3 CPG-100	[*] M84043.	3 CPG-100	4	-	-	WiFi
MYeBOX1500 + 3 CPG-100	[*] M84053.	3 CPG-100	5	2	2	WiFi + 3G
MYeBOX150 + 3 CPRG-500	[*] M84045.	3 CPRG-500	4	-	-	WiFi
MYeBOX1500 + 3 CPRG-500	[*] M84055.	3 CPRG-500	5	2	2	WiFi + 3G

Analysers with built-in SD memory and Cloud Includes voltage cables, alligator clips, USB cable, fastening strap, magnetic support, battery, power supply and carrying bag. Please contact us for other clamp or clamp length combinations

MYeBOX-A, Portable power analyzer with recording of quality events and transients Calibration Certificate (IEC 61000-4-30 Ed.2) Class A

Type	Code	Clamp	Measuring Channels	Transistor output	Digital inputs	Communications
kit MYeBOX-150	[*] M840230000A00	-	4	-	-	WiFi
kit MYeBOX-1500	[*] M840330000A00	-	5	2	2	WiFi + 3G
Portable analyzer kits with current sensors						
MYeBOX-150-3 FLEX-R45	[*] M8404B0000A00	3 FLEX-R45	4	-	-	WiFi
MYeBOX-1500-3 FLEX-R45	[*] M8405B0000A00	3 FLEX-R45	5	2	2	WiFi + 3G
MYeBOX-150- 4 FLEX-R45	[*] M8404C0000A00	4 FLEX-R45	4	-	-	WiFi
MYeBOX-1500- 4 FLEX-R45	[*] M8405C0000A00	4 FLEX-R45	5	2	2	WiFi + 3G
MYeBOX-150- 3 FLEX-R80	[*] M8404D0000A00	3 FLEX-R80	4	-	-	WiFi
MYeBOX-1500-3 FLEX-R80	[*] M8405D0000A00	3 FLEX-R80	5	2	2	WiFi + 3G
MYeBOX-150- 4 FLEX-R80	[*] M8404E0000A00	4 FLEX-R80	4	-	-	WiFi
MYeBOX-1500-4 FLEX-R80	[*] M8405E0000A00	4 FLEX-R80	5	2	2	WiFi + 3G
MYeBOX-150- 3 CPG-100	[*] M840430000A00	3 CPG-100	4	-	-	WiFi
MYeBOX-1500- 3 CPG-100	[*] M840530000A00	3 CPG-100	5	2	2	WiFi + 3G
MYeBOX-150- 3 CPRG-500	[*] M840450000A00	4 CPG-100	4	-	-	WiFi
MYeBOX-1500- 3 CPRG-500	[*] M840550000A00	4 CPG-100	5	2	2	WiFi + 3G

Analysers with built-in SD memory and Cloud Includes voltage cables, alligator clips, USB cable, fastening strap, magnetic support, battery, power supply and carrying bag. Please contact us for other clamp or clamp length combinations

CPG, Clamps

Type	I min - Measurement Range (A)	Nr Sensors	Code	Nr Sensors	Code	Nr Sensors	Code
CPG-5	0.05 - 0,5 ... 5 A	1	[*] M810B1.	3	[*] M810C1.	4	[*] M810D1.
CPG-100	1 - 10 ... 100 A	1	[*] M810B2.	3	[*] M810C2.	4	[*] M810D2.
CPRG-500	1 - 50 ... 500 A	1	[*] M810B3.	3	[*] M810C3.	4	[*] M810D3.
CPRG-1000	1 - 20 ... 1000 A	1	[*] M810B4.	3	[*] M810C4.	4	[*] M810D4.
CPG-2000/200	1 - 10 ... 200 A 10 - 150 ... 2000 A	1	[*] M810B5.	3	[*] M810C5.	4	[*] M810D5.

FLEX-RMG, Flexible Clamps

Type	I min - Measurement Range (A)	Sensor length	Nr Sensors	Code	Nr Sensors	Code	Nr Sensors	Code
kit 1 FLEX RMG70	1 - 10 ... 100 / 10 - 100 ... 1000	22 cm	1	[*] M81911.	3	[*] M81931.	4	[*] M81941.
kit 1 FLEX RMG120	50 - 1000 ... 10000	38 cm	1	[*] M81912.	3	[*] M81932.	4	[*] M81942.

FLEX-R, Flexible Clamps

Type	I min - Measurement Range (A)	Sensor length	Nr Sensors	Code	Nr Sensors	Code	Nr Sensors	Code
KIT 1 -FLEX-R45	1- 10 ... 100 /	45 cm	1	[*] M81611.	3	[*] M81631.	4	[*] M81641.
KIT 1-FLEX-R80	10 - 100 ... 1000	80 cm	1	[*] M81612.	3	[*] M81632.	4	[*] M81642.
KIT 1-FLEX-R120	50 - 1000 ... 10000	120 cm	1	[*] M81613.	3	[*] M81633.	4	[*] M81643.

MYeBOX Accessories

Type	Code	Description
MYeBOX BATTERY	[*] M84011.	MyEBOX battery
POWER SUPPLY MYeBOX	[*] M84012.	MYEBOX power cable
MARKER MYeBOX 9 COLOURS	[*] M84014.	Markers
MYeBOX 9 CARRYING BAG	[*] M84015.	Carrying bag
Belt MYeBOX	[*] M84016.	MyEBOX strap
Magnetic support MYeBOX	[*] M84017.	MyEBOX magnetic base



CIR-e+, Energy audit analyzer

Type	Code	Description	Device	Clamp
CIR-e+	[*] M85060.	CIR-e+ Portable energy audit analyzer without clamps	CIR-e+	-
CIR-e+ / 3 CPG-100	[*] M85070.	CIR-e+ energy audit analyser with three CPG100 sensors	CIR-e+	3 CPG-100
CIR-e+ / 3 EFLEX 54	[*] M85050.	CIR-e+ energy audit analyser with three 54 cm long E-FLEX sensors	CIR-e+	3 EFLEX 54

CPG, Clamps

Type	Code	Clamp	Measurement Range (A)	I min	Usefull diam.(mm)	Flat strip(mm)
KIT3 CPG-5	[*] M86019.	3 x CPG 5 CIR-e+	0,5 ... 5 A	0.05	20	20 x 5
KIT3 CPG-100	[*] M8601A.	3 x CPG 100 CIR-e+	10 ... 100 A	1	20	20 x 5
KIT3 CPRG-500	[*] M86016.	3 x CPRG 500 CIR-e+	50 ... 500 A	1	52	1 of 50 x 5 or 4 of 30 x 5
KIT3 CPRG-1000	[*] M86017.	3 x CPRG 1000 CIR-e+	20 ... 1000 A	1	52	1 of 50 x 5 or 4 of 30 x 5
KIT3 CPG-2000/200	[*] M86018.	3 x CPG 2000/200 CIR-e+	10 ... 200 A / 150 ... 2000 A	1 / 10	64	5 of 125 x 5 or 3 of 100 x 10

FLEX, Flexible Clamps

Type	Code	Clamp	Measurement Range (A)	I min	Sensor length
KIT3 AMS14-FLEX	[1] M86015.	3 x AMS14-FLEX	10 ... 100 A / 10 ... 200 A	1 / 2	14 cm
KIT3 CIRe3 FLEX 200..20kA 54	[1] M86010.	3 x FLEX 200..20kA 54	20 ... 200 A / 200 ... 2000 A / 2000 ... 20000 A	2 / 20 / 1000	54 cm
KIT3 CIRe3-FLEX 200..20kA 80	[1] M86013.	3 x FLEX 200..20kA 80	20 ... 200 A / 200 ... 2000 A / 2000 ... 20000 A	2 / 20 / 1000	80 cm
KIT3 CIRe3-FLEX 200..20kA 120	[1] M86014.	3 x FLEX 200..20kA 120	20 ... 200 A / 200 ... 2000 A / 2000 ... 20000 A	2 / 20 / 1000	120 cm
Kit 3 CIRE3-FLEX 100...10kA 54	[1] M8601B.	3 x FLEX 100...10kA 54	10 ... 100 A / 100 ... 1000 A / 1000 ... 10000 A	1 / 10 / 500	54 cm

Cire+ accessories

Type	Code	Description
Cables Comunicación RS-232	[2] M86030.	RS-232 Cable
Cables Tensión CIR-e+	[2] M86020.	Kit 6 cables (voltage measurement and power)
BOLSA TRANSPORTE CIR-e+	[*] M89931.	Carry bag

CAVA, Power Quality Single-Phase Analyzers

agrupador		
Type	Code	Description
CAVA 251	[C] Q20112.	Single-phase recorder of voltage, flicker and harmonics. RS-232 output
CAVA 252	[C] Q20122.	Single-phase recorder of voltage, current, flicker and harmonics. RS-232 output
CAVA 253	[C] Q20132.	Single-phase recorder of voltage, current, active power, flicker and harmonics. RS-232 output
Clamps		
CP-2000/200	[C] M81015.	Ammeter clamp 2000/200 A
CPR-1000	[C] M81014.	Ammeter clamp 1000 A
CPR-500	[C] M81013.	Ammeter clamp 500 A
CP-100	[C] M81012.	Ammeter clamp 100 A
CP-5	[C] M81011.	Ammeter clamp 5 A

VLOG, Power quality analyzer

Type	Code	Description
VLOG-10	[C] M84101.	Single-phase analyzer to collect and record outages, gaps, overvoltages and voltage load profile

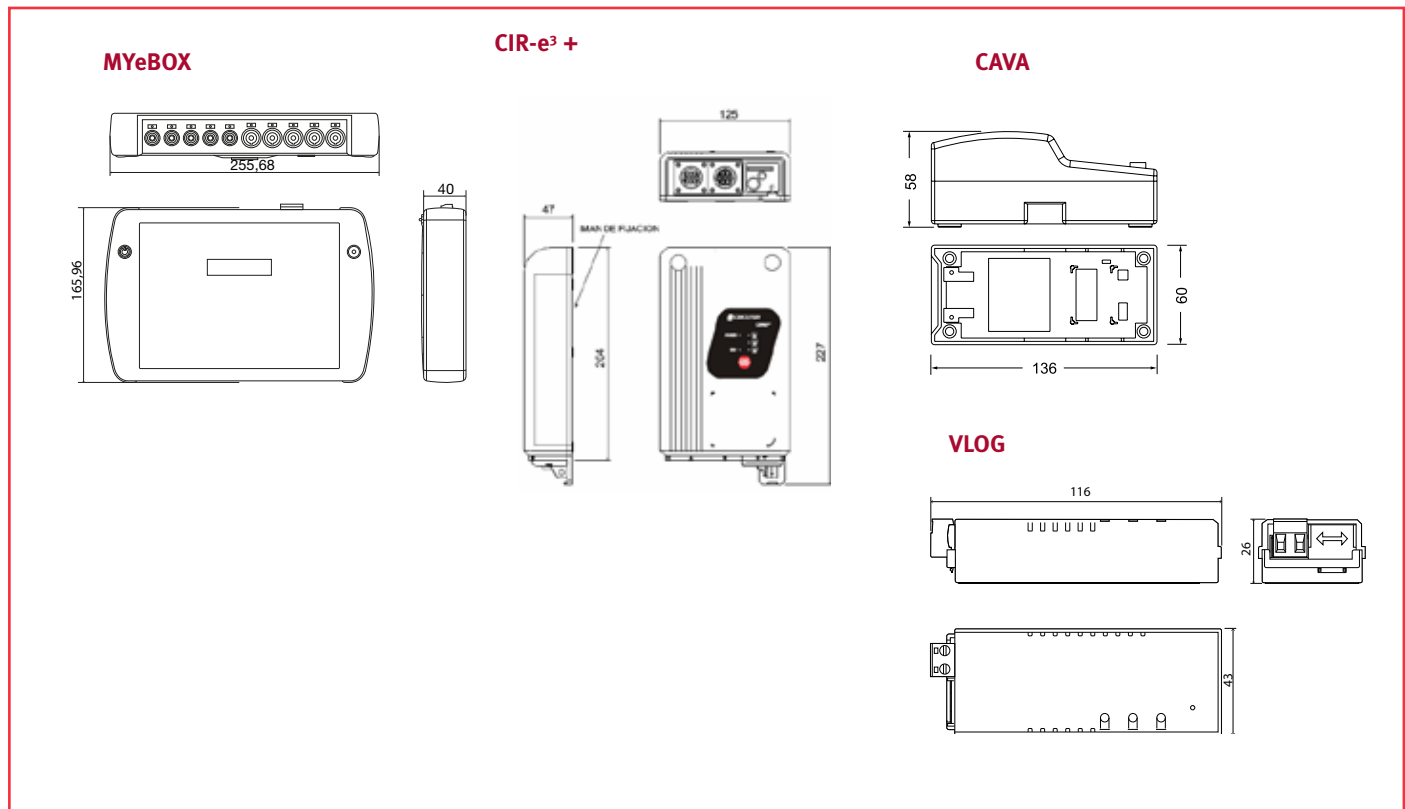

Accessories

Type	Code	Description
Bridas 5 colores AM54-FLEX	[*] M82502.	AM54-flex clamps, 5 colours tie bars
VCC-1	[*] M89909.	Crocodile clamp (1 unit)
MAV-7	[*] M8990C.	Voltage magnetic adapter 7 x 10 mm
MAV-7x3	[*] M8990D.	3 x Voltage magnetic adapter 7 x 10 mm
MAV-7x4	[*] M8990E.	4 x Voltage magnetic adapter 7 x 10 mm
MAV-7x5	[*] M8990F.	5 x Voltage magnetic adapter 7 x 10 mm

Dimensions

Digital instruments

Table: Digital instruments selection

		DM45	DC B	DHB	
					
Mounting	Pannel	-	48 x 48 72 x 72	96 x 48	
	DIN rail	2 modules			
AC measurement	Single-phase	•	•	•	
AC measurement Parameters	Voltage	•	T	T (DHB-300)	
	Current	•	T	T (DHB-300)	
	Active power(W)	-	-	T (DHB-300)	
	Frequenz (Hz)	•	T	T (DHB-300)	
	Maximum demand (A)	•	-	-	
DC measurement Parameters	Voltage	-	T	T (DHB-200)	
	Current	-	T	T (DHB-200)	
	process signal	-	T	T (DHB-400)	
Accuracy	0,1	-	-	T	
	0,50%	-	•	•	
	1%	•	-	-	
No electric parameters	Hour run meter	-	-	T (DHB-100)	
	Temperature	-	T	T (DHB-400)	
	Chronometer, impulse meter	-	-	T (DHB-100)	
	Tachometer (r/min)	-	-	T (DHB-100)	
Other options	auxiliar output relay	•	•	2 (4 Opc.)	
	Analog output	-	-	T	
	communications port	-	-	T	
	Auxliar power supply	•	•	-	
	Frontal adapter	-	•	-	
		Page	53	54	55

T - Depending type / OP - Optional

DM45, Digital instruments

DM45 series, Rail DIN, 230 V, 40...70 Hz



Type	Code	Paramètre	Measure	Output relay
DM45-V	[*] M20901.	Voltmeter	50...600 Vac	1
DM45-A	[*] M20911.	Ammeter	... / 5 Aac	1
DM45-AD	[*] M20921.	Ammeter	0,5 ... 30 Aac	1
DM45-F	[*] M20931.	Frequencymeter	10 ... 600 Hz	1
DM45-CM	[*] M20941.	Analizer(V, A, Hz, THD)	600 Vac / .../5 A /10...600 Hz	1
DM45-CMD	[*] M20951.	Analizer(V, A, Hz, THD)	600 Vac / .../5 A /10...600 Hz	1

Size: 2 modules.

DM45

Code	Internal code		
M 2 X X X X 0 0 X			
		↑	Delivery time
Auxiliary supply	Standard (230 V)	0	-
	100 ... 115 V _{ca}	1	1
	18 ... 36 V _{cc}	7	1

DC-B, Digital instruments

DC B Series, 230 Vac, 40...70 Hz, 0.5% FE

Type	Code	System	Measure	Scale	Size(mm)
Voltmeters / Process indicators					
DC48B V (150,300,600V)	[*] M20210.	AC	Direct: 600 Vac Transformer: Programmable	150, 300, 600 Vca	48x48
DC72B V (150,300,600V)	[*] M20220.	AC	Direct: 600 Vac Transformer: Programmable	150, 300, 600 Vca	72x72
DC48B V (10,50,200V)	[*] M20213.	DC	Direct: -200 / +200 Vdc (Process: 0...10 Vdc)	10, 50, 200 Vcc	48x48
DC72B V (10,50,200V)	[*] M20223.	DC	Direct: -200 / +200 Vdc (Process: 0...10 Vdc)	10, 50, 200 Vcc	72x72
DC48B V (600V)	[1] M20214.	DC	-600V / + 600 Vdc	600 Vcc	48x48
DC72B V (600V)	[*] M20224.	DC	-600 / + 600 Vdc	600 Vcc	72x72
DC48B mV (60,150,200mV)	[1] M20217.	DC	Direct: -200 mVdc / +200 mVdc Shunt: .../60 mVdc , .../150 mVdc	60, 150, 200 mVcc	48x48
DC72B mV (60,150,200mV)	[*] M20227.	DC	Direct: -200 mVdc / +200 mVdc Shunt: .../60 mVdc , .../150 mVdc	60, 150, 200 mVcc	72x72
Ammeters / Process indicators					
DC48B A (.../5A)	[*] M20211.	AC	Direct: 5 Aac Transformer: .../ 5 Aac	... / 5 Aca	48x48
DC72B A (.../5A)	[*] M20221.	AC	Direct: 5 Aac Transformer: .../ 5 Aac	... / 5 Aca	72x72
DC72B MD	[*] M2022A.	AC	Direct: 5 Aac Transformer: .../ 5 Aac 1 Relay	... / 5 Aca	72x72
DC48B A (10A)	[1] M20212.	AC	Direct: 10 Aca	10 Aca	48x48
DC72B A (10A)	[*] M20222.	AC	Direct: 10 Aac	10 Aca	72x72
DC48B A (5,20,200mA)	[1] M20215.	DC	Direct: -200 mA / + 200 mAdc (Process: 0...20 mAdc/ 4...20 mcdc)	5, 20, 200 mAcc	48x48
DC72B A (5,20,200mA)	[*] M20225.	DC	Direct: -200 mA / + 200 mcdc (Process: 0...20 mAdc/4...20 mcdc)	5, 20, 200 mAcc	72x72
DC48B A (10A)	[1] M20216.	DC	Direct: 10 Adc	10 Acc	48x48
DC72B A (10A)	[*] M20226.	DC	Direct: 10 Adc	10 Acc	72x72

All AC instruments measure TRMS values Please see the code table for other power supply values (110 Vdc power supply not available)

Accessories digital instruments

Type	Code	Description
Adap.Frontal 72x72 -> 96x96	[*] M29914.	Frontal adapter 72x72 > 96x96
Adap.Frontal 48x48 -> 72x72	[4] M29911.	Frontal adapter 48x48 > 72x72
Adap.Frontal 48x48 -> 96x96	[4] M29912.	Frontal adapter 48x48 > 96x96
Adap.Frontal 48x96 -> 96x96	[*] M29913.	Frontal adapter 48x48 > 96x96

CODIFICATION TABLE
DC

Code	Internal code		
M 2 X X X X 0 0 X X			
		↑	Delivery time
	Standard (230 V)	0	-
Power Supply auxiliar	100 ... 120 V _{ac}	1	2
	480 ... 500 V _{ac}	4	2
	9...18 V _{dc}	6	2
	18 ... 36 V _{dc}	7	2
Current input	Standard (.../5A)	0	-
	.../1 A .../1 A	1	2

 110 V_{dc} auxiliary supply not possible



DHB, Digital instruments

85 ... 253 Vac /Vdc power supply voltage

Type	Code	Paramètre	Measure	Output relay	Analog output	Communications
DHB-102	[1] M22021.	Impulses, frequency, circular speed, periods, worktime, encoder position	imp., Hz.	1	-	-
DHB-124	[1] M22022.	Impulses, frequency, circular speed, periods, worktime, encoder position	imp., Hz.	3	1	RS-485
DHB-202	[1] M22023.	Voltmeter or ammeter ± 100...500 Vdc ± 1/5 Adc	± 100...500 Vdc ± 1/5 Adc	2	-	-
DHB-224	[1] M22024.	Voltmeter or ammeter ± 100...500 Vdc ± 1/5 Adc	± 100...500 Vdc ± 1/5 Adc	4	1	RS-485
DHB-302	[1] M22025.	Single-phase analyzer	± 100/400 Vac ± 1/5 Aac	2	-	-
DHB-324	[1] M22026.	Single-phase analyzer	± 100/400 Vac ± 1/5 Aac	4	1	RS-485
DHB-402	[1] M22027.	Process / Resistance/ Temperature	Pt100/500/1000 Thermocouple J,K,N,E,R,S, ±20 mA, ±10 V, 60 mV	2	-	-
DHB-424	[1] M22028.	Process / Resistance/ Temperature	Pt100/500/1000 Thermocouple J,K,N,E,R,S, ±20 mA, ±10 V, 60 mV	4	1	RS-485



DH96, DC multimeter

DH 96 series, 230 Vac, 45...65 Hz (panel installation 96 x 48 mm)

Type	Code	Accuracy	System	Paramètre	Measure	Communications
DH96CPM	[*] M20419.	0,2 % (± 1dig)	DC	V, A, kW, kWh	Programmable.Selec. V : 100 / 300 / 800 Vdc	-
DH96CPM	[*] M2043F.	0,2 % (± 1dig)	DC	V, A, kW, kWh	Programmable.Selec. V : 100 / 300 / 800 Vdc	RS-485

CODIFICATION TABLE

DH 96

Code		Internal Code							
M	2	X	X	X	X	0	0	X	
								↑	Delivery time
								0	-
								1	2
								3	
Auxiliary supply								4	2
								7	2
								8	
								9	

DHB

Code		Internal Code							
M	2	X	X	X	X	0	0	X	
								↑	Delivery time
								0	-
Auxiliary supply								1	-
								2	1



	CVE / CV-A	CPF
	CV-D	CCOS
	CCE / CC-A / TP-420 / TC-020 / TCB / TCM	CR2
	CC-D	CT-PT100
	CW	CUP
	CY	CFE / CF

CVE/CCE/CFE, Narrow section transducers

Narrow section transducers, 230 Vac, 45...65 Hz



Type	Code	System	Measure	Output type	Analog output
AC Voltage transducer					
CVE-A	[*] M25011.	-	Selecting 110 / 300 / 400 / 500 / 690 Vac	2	4...20mA
CVE-A-AP	[3] M25021.	-	Selecting 115 / 240 / 400 Vac	1	0...20mA
AC Current transducer					
CCE-A	[*] M25111.	-	Selecting 1 / 5 / 10 Aac	2	4...20mA
CCE-A-AP	[*] M25121.	-	Selecting 1 / 5 / 10 Aac	1, 3	0...20mA
Frequency transducers					
CFE	[3] M25511.	Network voltage: 50 ... 600 Vac	Selecting 0-100 / 45-55 / 55-65 / 45-65 / 47-53 / 380-240 / 360-440 / 340-460 Hz	2	4...20mA
CFE-AP	[3] M25521.	Selecting Network voltage: 115 / 240 / 400 Vac	Selecting 0-100 / 45-55 / 55-65 / 45-65 / 47-53 / 380-240 / 360-440 / 340-460 Hz	1	0...20mA

Specified AS PER THE CODE TABLE: 1. Code/ 2. Input range / 3. Output range / 4. Auxiliary power supply / 5. Specify grid voltage in CFE-AP See the code table at the end of the section xxx-AP types external auxiliary supply not required. 4...20 mA output not possible.

INPUTS

Current AC	1 or 5, ... / 1 A or ... / 5 A
Current DC	500 μ A ... 10 A
Voltage AC	0 ... 690 V
Voltage DC	10 mV ... 500 V

OUTPUTS

Output 1	0...5 V, 0...10 V, 0...10 mA, 0...20 mA (by default)
Output 2	0,2...2 V, 2...10 V, 4...20 mA (by default)
Output 3	-10...0...10 V, -5...0...5 V, -20 mA...0...20 mA (by default)

CV, Transducer Voltage

Type	Code	Measure	Output type	Analog output
AC Voltage. Accuracy: \pm 0,2 % reading, 40...90 Hz				
CV-A-AP Out1	[1] M25041.	0 ... 400 Vac	1	0...20mA
CV-A Out1	[1] M25031.	0 ... 690 Vac	1	0...20mA
CV-A Out2	[1] M25032.	0 ... 690 Vac	2	4...20mA
CV-A-RMS Out1	[1] M25051.	0 ... 690 Vac	1	0...20mA
CV-A-RMS Out2	[1] M25052.	0 ... 690 Vac	2	4...20mA
DC Voltage. Auxiliary supply 230 V, 40...90 Hz, Accuracy: \pm 0,5 % reading				
CV-D Out1,3	[1] M25061.	10 mV ... 500 Vdc	1, 3	0...20mA
CV-D Out2	[1] M25062.	10 mV ... 500 Vdc	2	4...20mA

-AP type: Accuracy: \pm 0,5 % reading, 40...90 Hz. External auxiliary supply not required. Specify: Zero value, full scale and output type. See table at the end of This section

CC, Current transducer

Type	Code	Measure	Output type	Analog output
AC Current. Accuracy: \pm 0,2 % reading, 40...90 Hz				
CC-A Out1	[1] M25131.	... / 1 Aac or ... / 5 Aac	1	0...20mA
CC-A Out2	[*] M25132.	... / 1 Aac or ... / 5 Aac	2	4...20mA
CC-A-AP	[*] M25141.	... / 1 Aac or ... / 5 Aac	1	0...20mA
CC-A-RMS Out1	[1] M25151.	... / 1 Aac or ... / 5 Aac	1	0...20mA
CC-A-RMS Out2	[*] M25152.	... / 1 Aac or ... / 5 Aac	2	4...20mA
Courant C.C. Alimentation auxiliaire 230 V, 40...90 Hz, Précision: \pm 0,5 % lecture				
CC-D Out1	[1] M25161.	500 μ A ... 10 Adc	1, 3	0...20mA
CC-D Out2	[1] M25162.	500 μ A ... 10 Adc	2	4...20mA

-AP type: Accuracy: \pm 0,5 % reading, 40...90 Hz. External auxiliary supply not required. Specify: Zero value, full scale and output type. See table at the end of This section

**CW / CY, Power transducer**

Type	Code	System	Output type	Analog output
Active power. Auxiliary supply 230 V, 40...90 Hz, Accuracy: $\pm 0,5$ % reading				
CW-M Out1,3	[1] M25211.	Single-phase	1, 3	0...20mA
CW-M Out2	[1] M25212.	Single-phase	2	4...20mA
CW-TE Out1,3	[1] M25221.	Balanced three-phase	1, 3	0...20mA
CW-TE Out2	[1] M25222.	Balanced three-phase	2	4...20mA
CW-TA Out1,3	[1] M25231.	Unbalanced three-phase ARON (3 wires)	1, 3	0...20mA
CW-TA Out2	[1] M25232.	Unbalanced three-phase ARON (3 wires)	2	4...20mA
CW-TAN Out1,3	[1] M25241.	Unbalanced three-phase (4 wires)	1, 3	0...20mA
CW-TAN Out2	[1] M25242.	Unbalanced three-phase (4 wires)	2	4...20mA
Reactive power. Auxiliary supply 230 V, 40...90 Hz, Accuracy: $\pm 0,5$ % reading				
CY-M Out1,3	[1] M25251.	Single-phase	1, 3	0...20mA
CY-M Out2	[1] M25252.	Single-phase	2	4...20mA
CY-TE Sal.1,3	[1] M25261.	Balanced three-phase	1, 3	0...20mA
CY-TE Sal.2	[1] M25262.	Balanced three-phase	2	4...20mA
CY-TA Out1,3	[1] M25271.	Unbalanced three-phase ARON (3 wires)	1, 3	0...20mA
CY-TA Out2	[1] M25272.	Unbalanced three-phase ARON (3 wires)	2	4...20mA
CY-TAN Sal1,3	[1] M25281.	Unbalanced three-phase (4 wires)	1, 3	0...20mA
CY-TAN Out2	[1] M25282.	Unbalanced three-phase (4 wires)	2	4...20mA

Specify: zero value, full scale, output type, Un (between phases), In and fn, see table at the end of This section

**CPF / CCOS, Power Factor & Cosφ transducer**

Type	Code	System	Output type	Analog output
Cos φ. Auxiliary supply 230 V, 40...90 Hz, Accuracy: $\pm 0,5$ % reading				
CCOS-M Out1,3	[1] M25341.	Single-phase	1, 3	0...20mA
CCOS-M Out 2	[1] M25342.	Single-phase	2	4...20mA
CCOS-TE Out1,3	[1] M25351.	Balanced three-phase (3 wires)	1, 3	0...20mA
CCOS-TE Out2	[1] M25352.	Balanced three-phase (3 wires)	2	4...20mA
CCOS-TEN Sal1,3	[1] M25361.	Balanced three-phase (4 wires)	1, 3	0...20mA
CCOS-TEN Out2	[1] M25362.	Balanced three-phase (4 wires)	2	4...20mA
Power factor. Auxiliary supply 230 V, 40...90 Hz, Accuracy: $\pm 0,5$ % reading				
CPF-M Out1,3	[1] M25311.	Single-phase	1, 3	0...20mA
CPF-M Out2	[1] M25312.	Single-phase	2	4...20mA
CPF-TE Out1,3	[1] M25321.	Balanced three-phase (3 wires)	1, 3	0...20mA
CPF-TE Out2	[1] M25322.	Balanced three-phase (3 wires)	2	4...20mA
CPF-TEN Out1,3	[1] M25331.	Balanced three-phase (4 wires)	1, 3	0...20mA
CPF-TEN Out2	[1] M25332.	Balanced three-phase (4 wires)	2	4...20mA

Specify: zero value, full scale, output type, Un (between phases), In and fn, see table at the end of This section

**CF, Frequency transducers**

Type	Code	Measure	Output type	Analog output
Auxiliary supply 230 V, 40...90 Hz, Accuracy: $\pm 0,2$ % reading				
CF Out1	[3] M25531.	10 ... 660 Vac 0 ... 10 kHz.	1	0...20mA
CF Out2	[1] M25532.	10 ... 660 Vac 0 ... 10 kHz.	2	4...20mA

Specify: zero value, full scale, output type, Un (between phases), In and fn, see table at the end of This section

**Temp, Ohm, aislam, proceso, Transducers**



Type	Code	Measure	Output type	Analog output
Galvanic insulator transducer				
CC-G	[*] M25610.	500 μ A ... 10 Adc	1	0...20mA
Leakage current				
CC-WG Out2	[3] M25631.	0 ... 3 Aac	2	4...20mA
Resistance				
CR2 Out 1	[1] M25641.	1 ... 200 k Ω	1, 3	0...20mA
CR2 Out 2	[1] M25642.	1 ... 200 k Ω	2	4...20mA
Process universal				
CUP Out 2	[1] M25612.	Configurable	1,2,3	0...20mA/4...20mA
CT-PT100 Out1,3	[1] M25651.	According probe PT-100	1, 3	0...20mA
CT-PT100 Out2	[*] M25652.	According probe PT-100	2	4...20mA

Specify: zero value, full scale, output type, Un (between phases), In and fn, see table at the end of This section

TI, Current transformer with converter 4...20 mA

Type	TI-420			TP-420		TCM-420	TCB-420	
	TI-420-35	TI-420-70	TI-420-105	TP-420-23	TP-420-58	TCM-420-25	TCB-420-35	TCB-420-70
								
ø (mm)	35	70	105	-	-	25	35	70
Flat strip(mm)	-	-	-	20 x 30	50 x 80	-	-	-
width xheight xdepth (mm)	100x79x33	130x110x33	170x146x33	110x89x89	145x114x114	70x87x70	166x79x33	196x110x33
	10...28 Vdc supply, Output 4...20 mA					Output internal supply 4...20 mA (230 Vac Auxiliary supply)		
A	Code	Code	Code	Code	Code	Code	Code	Code
2.5	[1] M70811.					[2] M71041.	[3] M71011.	
5	[*] M70812.			[*] M70211.		[*] M71042.	[*] M71012.	
10	[*] M70813.			[*] M70212.		[*] M71043.	[*] M71013.	
20	[*] M70814.			[*] M70213.		[*] M71044.	[*] M71014.	
50	[*] M70815.			[*] M70214.		[*] M71045.	[*] M71015.	
100	[*] M70816.	[*] M70821.		[*] M70215.	[*] M70221.	[*] M71046.	[*] M71016.	[1] M71021.
200				[*] M70216.		[*] M71047.		
250	[*] M70817.	[*] M70822.	[1] M70831.	[*] M70217.	[*] M70222.		[*] M71017.	[*] M71022.
500		[*] M70823.	[1] M70832.	[*] M70218.	[*] M70223.			[*] M71023.
750		[*] M70824.	[1] M70833.		[*] M70224.			[*] M71024.
1000			[1] M70834.					
1500			[1] M70835.					

TC-020, Current transformers with converter 4...20 mA or 0...20 mA

Type	TC5-420	TC6-420	TC8-420	TC6-020	TC8-020
					
ø (mm)	20	28	44	28	44
Flat strip(mm)	25 x 5	40 x 10	60 x 12	40 x 10	60 x 12
width xheight xdepth (mm)	58x70x32	64x80.5x44	84.5x102x50	64x80.5x44	84.5x102x50
	Output 4...20 mA, ext. supply 7,5...36 Vdc			Output 0...20 mA	
A	Code	Code	Code	Code	Code
5	[*] M72112.				
10	[*] M72113.				
20	[*] M72114.				
50		[*] M72131.		[*] M72031.	
100		[*] M72132.		[*] M72032.	
200		[*] M72134.		[*] M72034.	
300		[*] M72136.		[*] M72036.	
500			[*] M72151.		[3] M72051.
1000			[*] M72152.		[1] M72052.
1500			[*] M72153.		[*] M72053.



CODIFICATION TABLE

Narrow section transducers

Code	Internal code	X X X X				Delivery time
M 2 X X X X 0 0		X	X	X	X	
Voltage CVE-A	Standard (300 V)	0				-
	110 V	1				2
	400 V	2				2
	500 V	3				2
	690 V	4				2
Voltage CVE-A-AP	Standard (230 V)	0				-
	110 V	1				2
	400 V	2				2
Current	Standard (5 A)	0				-
	1 A	1				2
	10 A	4				2
Frequency	Standard (45...55 Hz)	0				-
	55...65 Hz	1				2
	47...53 Hz	2				2
	45...65 Hz	3				2
	0...100 Hz	4				2
	380...420 Hz	5				2
	360...440 Hz	6				2
340...460 Hz	7				2	
CVE-A, CCE-A, CFE	Standard (4...20 mA)	0				-
	0...20 mA	1				2
	0...10 V	2				2
	2...10 V	3				2
CVE-A-AP, CCE-A-AP, CFE-AP	Standard (0...20 mA)	0				-
	0...10 V	1				2
Auxiliary supply	Standard (220...240 V)	0				-
	380...400 Vca 40/60 Hz	3				2
Net. voltage CFE-AP)	18...36 Vdc	7				2
	Standard (230 V)	0	0	0	0	2
	110 V	0	1	0	0	2
	400 V	0	2	0	0	2

For other values consult

Transducers

Code	Internal code	X X X			Delivery time
M 2 X X X X 0 0		X	X	X	
AC Voltage	Standard (300 V)	0			-
	110 V	1			1
	400 V	2			1
	500 V	3			1
	690 V	4			1
AC Current	Standard (5 A)	0			-
	1 A	1			1
	10 A	4			1
DC Voltage	Standard (10 V)	0			-
	60 mV	1			1
	1 V	2			1
	100 V	3			1
DC Current	500 V	4			1
	Standard (20 mA)	0			-
	200 mA	1			1
	1 A	2			1
	10 A	3			1
Power, power factor, cos φ (V, A)	300 V, .../5 A	N			1
	110 V, .../5 A	1			1
	400 V, .../5 A	2			1
	500 V, .../5 A	3			1
	600 V, .../5 A	4			1
	300 V, .../1 A	5			1
	110 V, .../1 A	6			1
	400 V, .../1 A	7			1
	500 V, .../1 A	8			1
600 V, .../1 A	9			1	
Leakage current, process universal	Standard (20 Ω)	0			-
	200 Ω	1			1
	2 kΩ	2			1
Resistance	20 kΩ	3			1
	Standard (-200...+200 °C)	0			-
	-200...+800 °C	1			1
Temperature	Standard (45...55 Hz)	0			-
	55...65 Hz	1			1
	47...53 Hz	2			1
	57...63 Hz	3			1
	0...100 Hz	4			1
Outputs 1, 3	Standard (20 mA)	0			-
	0...1 mA	1			1
	0...10 mA	2			1
	2 V	3			1
	5 V	4			1
	0...10 V	5			1
	-20...0...20 mA	6			1
	-10...0...10 V	7			1
-5...0...5 V	8			1	
Outputs 2	Standard (4...20 mA)	0			-
	2...10 V	2			1
Auxiliary supply	Standard (220...240 V)	0			-
	100...120 Vac	1			2
	380...400 Vca 40/60 Hz	3			2
	18...36 Vdc	7			2
	40...170 Vdc	9			2

Dimensions

DC B 72

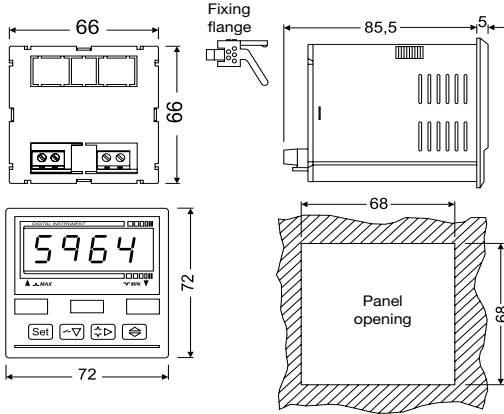

DM 45

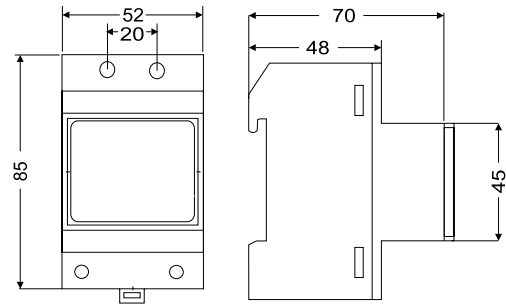

DHB

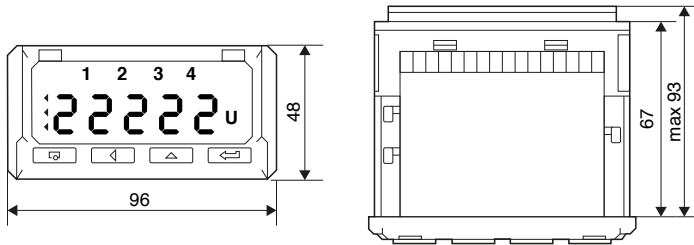

CVE / CEE / CCE / CFE

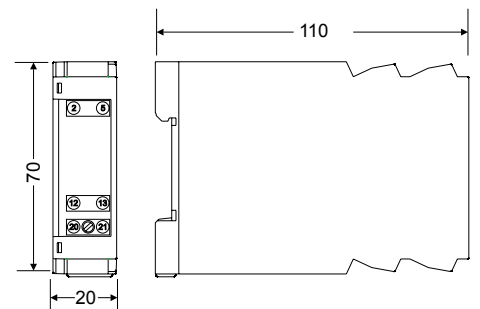

CV-A / CV-D / CC-A / CC-D / CR2 / CT-PT100 / CUP / CF

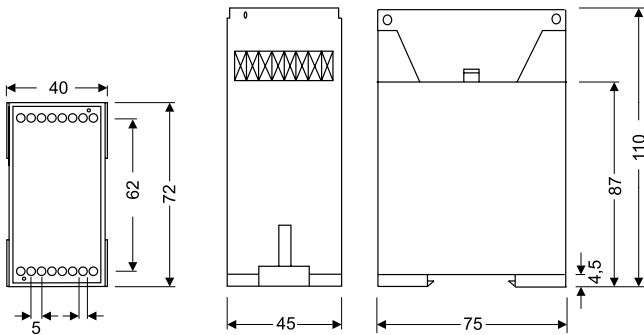

CW / CY / CPF / CCOS / CFD

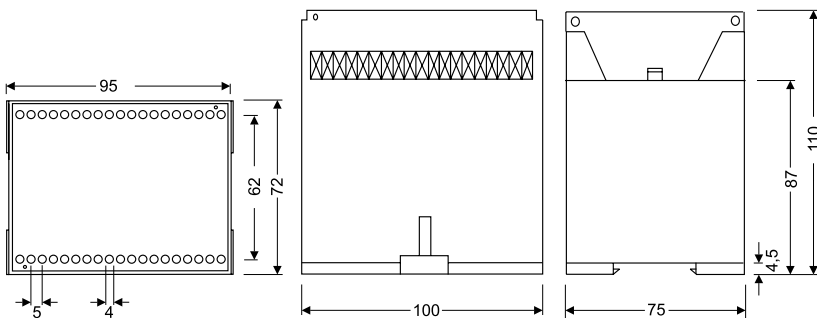



Analogue instrument selection table

	Measurement system	Assembly	Specifications	Range	Size mm	Accuracy class	Scale angle	Scale extension	Type		
Ammeters	AC 	Panel	Miliammeter	100...600 mA	48 x 48, 72 x 72, 96 x 96, 144 x 144	1,5	90°		EC		
			-	5...100 A, .../5A			240°	P2	EC		
		/5A	72 x 72, 96 x 96					EZC	
			With switch	.../5A				P1	EC FA		
			With relays	.../5A	96 x 96					CEC	
			DIN rail	-	5...60 A, .../5A		85 x 52		P2	EM 45	
Ammeters	CC 	Panel	-	5...60 A, .../60 mV	48 x 48, 72 x 72, 96 x 96, 144 x 144	1,5	90°		BC		
			With relays	... / 60 mV	96 x 96			P1	CBC		
			DIN rail	-	5...60 A, .../60 mV		85 x 52			BM 45	
			Voltmeters	AC 	Panel		-	150 ... 600 V, .../110 V	48 x 48, 72 x 72, 96 x 96, 144 x 144	1,5	90°
250 V, 500 V	72 x 72, 96 x 96	240°				P1	EZC				
Voltmeters	AC 	Panel	With relays	150 ... 600 V, .../110 V	96 x 96				EC F		
			DIN rail	-	300 V, 500 V, .../110 V	85 x 52				CEC	
Voltmeters	CC 	Panel	-	0...600 V	48 x 48, 72 x 72, 96 x 96, 144 x 144	1,5	90°		EM 45		
			With relays	... / 60 mV	96 x 96			P1	BC		
Voltmeters	CC 	Panel	With relays	... / 60 mV	96 x 96				CBC		
			DIN rail	-	15...150 V	85 x 52				P1	
Process indicators	CC 	Panel	-	0...10 V, 0/4... 20 mA	48 x 48, 72 x 72, 96 x 96, 144 x 144	1,5	90°	P1	BC		
			0...10 V, 4... 20 mA, .../60 mV		240°		P1	ZC			
			DIN rail	-	0...10 V, 0/4... 20 mA		85 x 52		90°		BM
Maximeters	-	Panel	Bimetallic			3		P1,2	MC		
			Bimetallic + HM	.../5 A				P2	EMC		
			DIN rail	Bimetallic			85 x 52			P1,2	MMC 45
Sheet	Needle	Panel	-		48 x 48, 72 x 72, 96 x 96, 144 x 144	0,5	90°		HC		
			-		96 x 96, 144 x 144		240°		HZC		
		DIN rail	-	45...65 Hz depending type	85 x 52			90°	-	HM	
Sheet	Sheets	Panel	-		72 x 72, 96 x 96, 144 x 144				HLC		
Wattmeter	Panel	Single-phase		400 V, .../5 A	96 x 96, 144 x 144	1,5	90°	P1	WMC		
		Three-phase							WTC		
Varmeter	Panel	Single-phase		400 V, .../5 A	96 x 96, 144 x 144	1,5	90°	P1	YMC		
		Three-phase							YTC		
Phase-meters	Electronic	Panel	Single-phase			1,5	90°	P1	FEMC		
			Three-phase	cos φ 0,5 - 1 - 0,5					FETC		
			Single-phase						240°		FMZ
			Three-phase		96 x 96, 144 x 144						FTZ
	Induction	Panel	Single-phase		cos φ 0 - 1 - 0					PIC	
			Three-phase		cos φ 0 - 1 - 0			90°		PIC	

Analogue instruments

EC / EM / EZC / CEC, Moving Iron Milliampmeters and Ammeter



Milliampmeters and Ammeters, 90° - P2 - Class 1,5

Type						
	EC 48	EC 72	EC 96	EC 144	EM 45	
a	48	72	96	144	85	
b	48	72	96	144	52	
c	86,2	69,2	69,2	91,8	65	
mA						
100	[*] M10111	[*] M10121	[*] M10131	[*] M10141	[*] M10151	
150	[*] M10112	[*] M10122	[*] M10132	[*] M10142	[*] M10152	
250	[*] M10114	[*] M10124	[*] M10134	[*] M10144	[*] M10154	
300	[*] M10115	[*] M10125	[*] M10135	[*] M10145	[*] M10155	
400	[*] M10116	[*] M10126	[*] M10136	[*] M10146	[*] M10156	
500	[*] M10117	[*] M10127	[*] M10137	[*] M10147	[*] M10157	
600	[*] M10118	[*] M10128	[*] M10138	[*] M10148	[*] M10158	
A						
5	[*] M10212	[*] M10222	[*] M10232	[3] M10242	[1] M10252	
10	[*] M10213	[*] M10223	[*] M10233	[3] M10243	[*] M10253	
15	[*] M10214	[*] M10224	[*] M10234	[3] M10244	[*] M10254	
20	[*] M10215	[*] M10225	[*] M10235	[3] M10245	[1] M10255	
25	[*] M10216	[*] M10226	[*] M10236	[3] M10246	[*] M10256	
30	[*] M10217	[*] M10227	[1] M10237	[3] M10247	[*] M10257	
40	[*] M10218	[*] M10228	[*] M10238	[3] M10248	[*] M10258	
50	[*] M10219	[*] M10229	[*] M10239	[3] M10249	[3] M10259	
60	[*] M1021A	[*] M1022A	[*] M1023A	[3] M1024A	[3] M1025A	
75	-	[*] M1022B	[1] M1023B	[3] M1024B	-	
100	-	[*] M1022C	[*] M1023C	[3] M1024C	-	
.../5 A (*1)	[*] M10210	[*] M10220	[*] M10230	[3] M10240	[*] M10250	

(*1) Exchangeable scales. See next page.

	Ammeters, 240°		Ammeters with phase switch		Ammeters with 2 relays	
Type	EZC 72	EZC 96	EC 72 FA	EC 96 FA	CEC 96	
Class	5		1,5		1,5	
Scale	240°, P2		90°, P1		90°, P2	
a	72	96	72	96	96	
b	72	96	72	96	96	
c	69,2	69,2	69,2	69,2	85,3	96
A						
(*2) .../5 A (*1)	[3] M10920	[3] M10930	[*] M10521	[*] M10531	[*] M14810	

(*1) Exchangeable scales. See next page.

(*2) Specify primary current of the measuring transformer

Exchangeable scales, moving iron ammeters

Type	SEC 48	SEC 72	SEC 96	SEM 45	SEC 72 FA	SEC 96 FA	SEZC 72	SEZC 96
Equipment	EC 48	EC 72	EC 96	EM 45	EC 72 FA	EC 96 FA	EZC 72	EZC 96
A								
5/5	[*] M102Z2	[*] M102Y2	[*] M102X2	-	-	-	[2] M109Y2	[*] M109X2
10/5	[*] M102Z3	[*] M102Y3	[*] M102X3	-	-	-	[*] M109Y3	[*] M109X3
15/5	[*] M102Z4	[*] M102Y4	[*] M102X4	-	-	-	[*] M109Y4	[*] M109X4
20/5	[*] M102Z5	[*] M102Y5	[*] M102X5	-	-	-	[*] M109Y5	[*] M109X5
25/5	[*] M102Z6	[*] M102Y6	[*] M102X6	-	-	-	[*] M109Y6	[*] M109X6
30/5	[*] M102Z7	[*] M102Y7	[*] M102X7	-	-	-	[*] M109Y7	[*] M109X7
40/5	[*] M102Z8	[*] M102Y8	[*] M102X8	-	-	-	[*] M109Y8	[2] M109X8
50/5	[*] M102Z9	[*] M102Y9	[*] M102X9	[*] M102V9	[*] M105Y9	[*] M105X9	[*] M109Y9	[2] M109X9
60/5	[*] M102ZA	[*] M102YA	[*] M102XA	[*] M102VA	[2] M105YA	[*] M105XA	[*] M109YA	[*] M109XA
75/5	[*] M102ZB	[*] M102YB	[*] M102XB	[*] M102VB	[*] M105YB	[*] M105XB	[*] M109YB	[*] M109XB
100/5	[*] M102ZC	[*] M102YC	[*] M102XC	[*] M102VC	[*] M105YC	[*] M105XC	[2] M109YC	[2] M109XC
125/5	[*] M102ZD	[*] M102YD	[*] M102XD	[*] M102VD	[2] M105YD	[*] M105XD	[*] M109YD	[*] M109XD
150/5	[*] M102ZE	[*] M102YE	[*] M102XE	[*] M102VE	[*] M105YE	[2] M105XE	[2] M109YE	[2] M109XE
200/5	[*] M102ZF	[*] M102YF	[*] M102XF	[*] M102VF	[*] M105YF	[*] M105XF	[2] M109YF	[2] M109XF
250/5	[*] M102ZG	[*] M102YG	[*] M102XG	[1] M102VG	[*] M105YG	[*] M105XG	[2] M109YG	[2] M109XG
300/5	[*] M102ZH	[*] M102YH	[*] M102XH	[*] M102VH	[*] M105YH	[*] M105XH	[2] M109YH	[*] M109XH
400/5	[*] M102ZJ	[*] M102YJ	[*] M102XJ	[*] M102VJ	[*] M105YJ	[*] M105XJ	[*] M109YJ	[2] M109XJ
500/5	[2] M102ZK	[*] M102YK	[*] M102XK	[*] M102VK	[*] M105YK	[*] M105XK	[*] M109YK	[*] M109XK
600/5	[*] M102ZL	[*] M102YL	[*] M102XL	[*] M102VL	[*] M105YL	[*] M105XL	[*] M109YL	[2] M109XL
750/5	[*] M102ZM	[*] M102YM	[*] M102XM	[*] M102VM	[*] M105YM	[*] M105XM	[*] M109YM	[2] M109XM
800/5	[*] M102ZN	[*] M102YN	[*] M102XN	[*] M102VN	[*] M105YN	[*] M105XN	[*] M109YN	[*] M109XN
1 000/5	[*] M102ZP	[*] M102YP	[*] M102XP	[1] M102VP	[*] M105YP	[*] M105XP	[*] M109YP	[2] M109XP
1 200/5	[*] M102ZQ	[*] M102YQ	[*] M102XQ	[1] M102VQ	[*] M105YQ	[*] M105XQ	[*] M109YQ	[*] M109XQ
1 500/5	[*] M102ZR	[*] M102YR	[*] M102XR	[1] M102VR	[*] M105YR	[*] M105XR	[2] M109YR	[*] M109XR
2 000/5	[*] M102ZS	[*] M102YS	[*] M102XS	[1] M102VS	[*] M105YS	[*] M105XS	[*] M109YS	[2] M109XS
2 500/5	[*] M102ZT	[*] M102YT	[*] M102XT	[1] M102VT	[*] M105YT	[*] M105XT	[*] M109YT	[*] M109XT
3 000/5	[*] M102ZU	[*] M102YU	[*] M102XU	[1] M102VU	[*] M105YU	[*] M105XU	[*] M109YU	[2] M109XU
4 000/5	[*] M102ZV	[*] M102YV	[*] M102XV	[1] M102VV	[*] M105YV	[*] M105XV	[*] M109YV	[2] M109XV
5 000/5	[*] M102ZW	[2] M102YW	[*] M102XW	[1] M102VW	[*] M105YW	[*] M105XW	[*] M109YW	[*] M109XW

CODIFICATION TABLE

EC, EZC

Code		Internal code		
M 1 X X X X 0 0		X	X	X
		↑	↑	↑
		Delivery time		
Adjustment	Standard 2P	0		-
	1P	1		2
	5P	6		2
Current input	Standard (.../5 A)	0		-
	... / 1 A	1		1
Scales(*)	1		1	2
	5		2	2
	10		3	2
	15		4	2
	20		5	2
	25		6	2
	30		7	2
	40		8	2
	50		9	2
	60		A	2
	75		B	2
	100		C	2
	125		D	2
	150		E	2
	200		F	2
	250		G	2
	300		H	2
	400		J	2
	500		K	2
	600		L	2
750		M	2	
800		N	2	
1000		P	2	
1200		Q	2	
1500		R	2	
2000		S	2	
2500		T	2	
3000		U	2	
4000		V	2	
5000		W	2	

EC (mA), EM (mA)

Code		Internal code		
M 1 X X X X 0 0		X		
		↑		
		Delivery time		
Adjustment	Standard 2P	0		-
	1P	1		2
	5P	6		2

SEC, SEM, EM

Code		Internal code		
M 1 X X X X 0 0		X	X	
		↑	↑	
		Delivery time		
Adjustment	Standard 2P	0		-
	1P	1		2
	5P	6		2
Current input	Standard (.../5 A)	0		-
	... / 1 A	1		1

EC FA

Code		Internal code		
M 1 X X X X 0 0		X	X	
		↑	↑	
		Delivery time		
Adjustment	Standard 1P	0		-
	5P	6		2
Current input	Standard (.../5 A)	0		-
	... / 1 A	1		1

CEC

Code		Internal code		
M 1 X X X X 0 0		X	X	
		↑	↑	
		Delivery time		
Scales	60	A		-
	75	B		-
	100	C		-
	125	D		-
	150	E		-
	200	F		-
	250	G		-
	300	H		-
	400	J		-
	500	K		-
	600	L		-
	750	M		-
	800	N		-
	1000	P		-
	1200	Q		-
1500	R		-	
2000	S		-	
2500	T		-	
3000	V		-	
Current input	Standard (.../5 A)	0		-
	... / 1 A	1		1
	/10 A	4		1



EC / EM / EZC / CEC, Moving Iron Voltmeters

	Voltmeters, 90°				Voltmeters, 90°	Voltmeters, 240°	
Type	EC 48	EC 72	EC 96	EC 144	EM 45	EZC 72	EZC 96
Class	1,5				1,5	5	
Scale	90°, P1				90°, P1	240°, P1	
a	48	72	96	144	85	72	96
b	48	72	96	144	52	72	96
c	86,2	69,2	69,2	91,8	65	69,2	69,2
V							
250	[*] M10415	[*] M10425	[*] M10435	[3] M10445	-	[3] M11125	[3] M11135
300	[*] M10416	[*] M10426	[*] M10436	[3] M10446	[*] M10456	-	-
400	[1] M10417	[1] M10427	[1] M10437	[3] M10447	-	-	-
500	[*] M10418	[*] M10428	[*] M10438	[3] M10448	[*] M10458	[3] M11128	[3] M11138
600	[1] M10419	[*] M10429	[1] M10439	[3] M10449	-	-	-
.../110 V(*)	[1] M10410	[*] M10420	[*] M10430	[3] M10440	[1] M10450	-	-

(*) Exchangeable scales, Voltmeters 90°

	Voltmeters with phases switch					Voltmeters with 2 relays	
	Three-phase 3 wire		Three-phase 4 wire		with sequence meter		
Type	EC 72 F III	EC 96 F III	EC 72 F III +N	EC 96 F III +N	EC 96 FN-S	CEC 96	
Class	1,5					1,5	
Scale	90°, P1					90°, P1	
a	72	96	72	96	96	96	
b	72	96	72	96	96	96	
c	69,2	69,2	69,2	69,2	69,2	85,3	
V							
150	-	-	-	-	-	[3] M14821	
250	[*] M10625	[3] M10635	[3] M10725	[3] M10735	-	[3] M14822	
300	[*] M10626	[*] M10636	[*] M10726	[*] M10736	-	[3] M14823	
400	[*] M10627	[3] M10637	[*] M10727	[3] M10737	-	[3] M14824	
500	[*] M10628	[*] M10638	[*] M10728	[*] M10738	[2] M11038	[3] M14825	
600	[*] M10629	[3] M10639	[2] M10729	[3] M10739	-	[3] M14826	
(1).../110 V	-	[2] M10632	-	-	-	[3] M14820	

(1) Specify primary voltage of the measuring transformers

Exchangeable scales, moving iron voltmeters, 1,2P

Type	SEC 48	SEC 72	SEC 96	SEM 45
Equipment	EC 48	EC 72	EC 96	EM 45
V				
1 000/110	[1] M104Z1	[1] M104Y1	[1] M104X1	[1] M104V1
3 300/110	[1] M104Z2	[1] M104Y2	[1] M104X2	[1] M104V2
6 600/110	[1] M104Z3	[1] M104Y3	[1] M104X3	[1] M104V3
13 200/110	[1] M104Z4	[1] M104Y4	[1] M104X4	[1] M104V4
15 000/110	[1] M104Z5	[1] M104Y5	[1] M104X5	[1] M104V5
20 000/110	[1] M104Z6	[1] M104Y6	[1] M104X6	[1] M104V6
22 000/110	[1] M104Z7	[1] M104Y7	[1] M104X7	[1] M104V7
25 000/110	[1] M104Z8	[1] M104Y8	[1] M104X8	[1] M104V8

CODIFICATION TABLE

EC Voltmeters with external transformer and EZC

Code	Internal code		
M 1 X X X X 0 0 X X X			
		↑	↑
Adjustment	Standard 1,2P	0	-
	1P	1	2
	Standard (.../110 V)	0	-
Voltage input	... / 100 V	1	1
	... / 63,5 V	2	1
	... / 57,8 V	3	1
	1000	1	2
	3300	2	2
Scales (For equipments with external transformer and all EC)	6600	3	2
	13200	4	2
	15000	5	2
	20000	6	2
	22000	7	2
	25000	8	2

EC and EC-F direct Voltmeters

Code	Internal code		
M 1 X X X X 0 0 X			
		↑	↑
Adjustment	Standard 1P	0	-
	1,2P	2	2

EC scales and EM Voltmeters and scales

Code	Internal code		
M 1 X X X X 0 0 X X			
		↑	↑
Adjustment	Standard 1,2P	0	-
	1P	1	2
	Standard (.../110 V)	0	-
Voltage inputs	... / 100 V	1	1
	... / 63,5 V	2	1
	... / 57,8 V	3	1



BC / BM / CBC, Moving coil ammeters

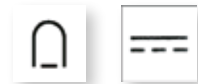

Type	Ammeters, 90°				Ammeters, 90°		ammeters with 2 relays
	BC 48	BC 72	BC 96	BC 144	BM 45	CBC 96	
Class	1,5				1,5		1,5
Scale	90°, P1				90°, P1		90°, P1
a	48	72	96	144	85	96	
b	48	72	96	144	52	96	
c	86,2	69,2	69,2	91,8	65	85,3	
5	[3] M11412	[*] M11422	[3] M11432	[3] M11442	[3] M11452	-	
10	[3] M11413	[*] M11423	[3] M11433	[3] M11443	[*] M11453	-	
25	[*] M11416	[*] M11426	[*] M11436	[3] M11446	[3] M11456	-	
50	[3] M11419	[*] M11429	[3] M11439	[3] M11449	[*] M11459	-	
60	-	[3] M1142A	[3] M1143A	[3] M1144A	-	-	
.../60 mV(*)	[*] M11410	[*] M11420	[*] M11430	[3] M11440	[3] M11450	[3] M14830	

(*) Exchangeable scales. See M.7 for external shunts

Exchangeable Scales

Type	SBC 48	SBC 72	SBC 96	SBM 45	Type	SBC 48	SBC 72	SBC 96	SBM 45
Device	BC 48	BC 72	BC 96	BM 45	Device	BC 48	BC 72	BC 96	BM 45
A / mV					A / mV				
50/60	[1] M114Z9	[*] M114Y9	[*] M114X9	[1] M114V9	300/60	[1] M114ZH	[1] M114YH	[1] M114XH	[1] M114VH
60/60	[1] M114ZA	[1] M114YA	[1] M114XA	[1] M114VA	400/60	[1] M114ZJ	[1] M114YJ	[*] M114XJ	[1] M114VJ
75/60	[1] M114ZB	[1] M114YB	[1] M114XB	[1] M114VB	600/60	[1] M114ZL	[*] M114YL	[*] M114XL	[1] M114VL
100/60	[1] M114ZC	[*] M114YC	[*] M114XC	[1] M114VC	1 000/60	[1] M114ZP	[1] M114YP	[*] M114XP	[1] M114VP
150/60	[1] M114ZE	[1] M114YE	[1] M114XE	[1] M114VE	1 500/60	[1] M114ZR	[1] M114YR	[1] M114XR	[1] M114VR
200/60	[1] M114ZF	[*] M114YF	[*] M114XF	[1] M114VF	2 500/60	[1] M114ZT	[1] M114YT	[1] M114XT	[1] M114VT
250/60	[1] M114ZG	[1] M114YG	[1] M114XG	[1] M114VG					

CODIFICATION TABLE

BC and BM ammeter				
Code	Internal code			Delivery time
M 1 X X X X 0 0	X	X	X	
Adjustment	Standard	0		-
	central zero	1		2
Shunt input range	Standard (.../60 mV)	0		-
	... / 50 mV	1		2
	... / 150 mV	3		2
	... / 300 mV	5		2
Scale	50	9		2
	60	A		2
	75	B		2
	100	C		2
	150	E		2
	200	F		2
	250	G		2
	300	H		2
	400	J		2
	500	K		2
600	L		2	
1000	P		2	
1500	R		2	
2500	T		2	

SBC, SBM45 scales				
Code	Internal code			Delivery time
M 1 X X X X 0 0	X	X	X	
Adjustment	Standard	0		-
	central zero	1		2
Shunt input range	Standard (.../60 mV)	0		-
	... / 50 mV	1		2
	... / 150 mV	3		2
	... / 300 mV	5		2

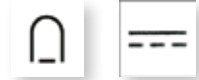
BC / BM / CBC, Moving coil voltmeters

	Voltmeters, 90°				Voltmeters, 90°	Voltmeters with relay
Type						
Type	BC 48	BC 72	BC 96	BC 144	BM 45	CBC 96
Class	1,5				1,5	1,5
Scale	90°, P1				90°, P1	90°, P1
a	48	72	96	144	85	96
b	48	72	96	144	52	96
c	86,2	69,2	69,2	91,8	65	85,3
V						
0...10 V (*1)	[*] M11813	[*] M11823	[*] M11833	[3] M11843	-	-
1	[3] M11711	[1] M11721	[1] M11731	[3] M11741	-	-
15	[*] M11714	[*] M11724	[*] M11734	[3] M11744	[3] M11754	-
30	[*] M11716	[*] M11726	[*] M11736	[3] M11746	[3] M11755	-
60	[*] M11718	[*] M11728	[*] M11738	[3] M11748	[3] M11756	-
100	[3] M11719	[*] M11729	[*] M11739	[3] M11749	[3] M11757	
150	[3] M1171A	[*] M1172A	[*] M1173A	[3] M1174A	[*] M11758	[3] M14841
250	[3] M1171B	[*] M1172B	[*] M1173B	[3] M1174B	-	[3] M14842
300	-	-	-	-	-	[3] M14843
400	[3] M1171D	[*] M1172D	[*] M1173D	[3] M1174D	-	[3] M14844
500	[3] M1171E	[*] M1172E	[1] M1173E	[3] M1174E	-	[3] M14845
600	[3] M1171F	[1] M1172F	[1] M1173F	[3] M1174F	[3] M1175F	[3] M14846

(*1) Scale NOT included

CODIFICATION TABLE

BC and BM equipment

Code	Internal code	
M 1 X X X X 0 0 X		
		↑ Delivery time
Adjustment	Standard	0 -
	Central zero	1 2

BC / BM / ZC, Process indicators



Process indicators, 90°

Type	BC 48	BC 72	BC 96	BC 144	BM 45
Class	1,5				1,5
Scale	90°, P1				90°, P1
	48 48 86,2	72 72 69,2	96 96 69,2	144 144 91,8	85 52 65
Scope					
0...10 V	[*] M11813	[*] M11823	[*] M11833	[3] M11843	[3] M11853
0...20 mA	[1] M11812	[1] M11822	[1] M11832	[3] M11842	[3] M11852
4...20 mA	[*] M11811	[*] M11821	[*] M11831	[3] M11841	[3] M11851

Scales NOT included

Exchangeable scales

Type	SIP 48	SIP 72	SIP 96	SIPM 45
Equipment	BC 48	BC 72	BC 96	BM 45
Scope				
0...10 V	[3] M118Z3	[3] M118Y3	[3] M118X3	[1] M118V3
0...20 mA	[3] M118Z2	[3] M118Y2	[3] M118X2	[1] M118V2
4...20 mA	[3] M118Z1	[3] M118Y1	[3] M118X1	[1] M118V1

Process indicators, 240°

Type			
	ZC 72	ZC 96	ZC 144
Class	1,5		
Scale	240°, P1		
	72 72 69,2	96 96 69,2	144 144 91,8
Scope			
0...10 V	[1] M12523	[1] M12533	[1] M12543
4...20 mA(*)	[1] M12521	[1] M12531	[1] M12541
.../60 mV	[1] M12520	[1] M12530	[1] M12540

(*) Scale included in the price

The 6-digit code already includes the 4...20 mA scale

CODIFICATION TABLE

BC and ZC process indicators

Code		Internal code			Delivery time
M	1	X	X	X	
				0 0 X X X	
Adjustment	Standard			0	-
	Central zero			1	2
Scale	1			1	2
	5			2	2
	10			3	2
	15			4	2
	20			5	2
	25			6	2
	30			7	2
	40			8	2
	50			9	2
	60			A	2
	75			B	2
	100			C	2
	125			D	2
	150			E	2
	200			F	2
	250			G	2
	300			H	2
	400			J	2
	500			K	2
	600			L	2
750			M	2	
800			N	2	
1000			P	2	
1200			Q	2	
1500			R	2	
2000			S	2	
2500			T	2	
3000			U	2	
4000			V	2	
5000			W	2	
Unit	-			0	2
	mA			1	2
	A			2	2
	kA			3	2
	mV			4	2
	V			8	2
	kV			9	2
	rpm			A	2
	rpm x 1000			B	2
	l (litros)			C	2
	m			G	2
	m ²			H	2
m ³			J	2	
%			K	2	

(*) Only for ZC equipments. 0 € for SIP scales



MC / MMC / EMC, maximeter ammeters

Bimetallic maximeter ammeter					Bimetallic maximeter ammeters + moving iron ammeters			
Type	MC 48	MC 72	MC 96	MC 144	MMC 45	EMC 72	EMC 96	EMC 144
Class	3					Bimetallic: 3 Moving iron:1,5		
Scale	90°, P1,2					Double Scale 90°, P1,2, moving iron P2		
a	48	72	96	144	85	72	96	144
b	48	72	96	144	52	72	96	144
c	86,2	69,2	69,2	91,8	65	69,2	69,2	91,8
A								
.../ 5 A	[1] M12211	[*] M12221	[*] M12231	[3] M12241	[*] M12651	[*] M12622	[*] M12632	[3] M12642

Scales NOT included	
Scale	120% 90°, P1,2
.../ 5 A	[3] M15521 [3] M15531

Scale included	
----------------	--

Exchangeable scales

Type	SMC 48	SMC 72	SMC 96	SMMC 45-A	SEMC 72	SEMC 96
Equipment	MC 48	MC 72	MC 96	MMC 45	EMC 72	EMC 96
A						
100/5	[1] M122ZC	[*] M122YC	[*] M122XC	[1] M126VC	[*] M126YC	[*] M126XC
200/5	[*] M122ZF	[*] M122YF	[*] M122XF	[1] M126VF	[*] M126YF	[*] M126XF
300/5	[*] M122ZH	[*] M122YH	[*] M122XH	[1] M126VH	[*] M126YH	[*] M126XH
400/5	[*] M122ZJ	[*] M122YJ	[*] M122XJ	[1] M126VJ	[*] M126YJ	[*] M126XJ
500/5	[*] M122ZK	[*] M122YK	[*] M122XK	[1] M126VK	[*] M126YK	[*] M126XK
600/5	[1] M122ZL	[3] M122YL	[*] M122XL	[1] M126VL	[3] M126YL	[*] M126XL
750/5	[1] M122ZM	[3] M122YM	[*] M122XM	[1] M126VM	[*] M126YM	[*] M126XM
800/5	[1] M122ZN	[*] M122YN	[*] M122XN	[1] M126VN	[*] M126YN	[*] M126XN
1 000/5	[1] M122ZP	[*] M122YP	[*] M122XP	[1] M126VP	[*] M126YP	[*] M126XP
1 500/5	[1] M122ZR	[*] M122YR	[*] M122XR	[1] M126VR	[*] M126YR	[*] M126XR
2 000/5	[1] M122ZS	[*] M122YS	[*] M122XS	[1] M126VS	[*] M126YS	[*] M126XS

CODIFICATION TABLE

MC and EMC maximeters and SMC and SEMC scales

Code	Internal code	Delivery time
M 1 X X X X 0 0 X X X		
Standard (15 minutes)	0	-
Adjustment		
8 minutes	1	1
30 minutes	2	2
Current input		
Standard (.../5 A)	0	-
.../ 1 A	1	1
Scale		
100	C	2
125	D	2
150	E	2
200	F	2
250	G	2
300	H	2
400	J	2
500	K	2
600	L	2
750	M	2
800	N	2
1000	P	2
1200	Q	2
1500	R	2
2000	S	2
2500	T	2
3000	U	2
4000	V	2
5000	W	2

MMC 45 Maximeter

Code	Internal code	Delivery time
M 1 X X X X 0 0 X		
Standard (15 minutes)	0	-
Adjustment		
8 minutes	1	1
30 minutes	2	2

Delivery time: [*] immediate
 [X] working weeks
 [c] consult

HC / HM / HZC / HLC, Frequency meters

	Pointer type frequency meters, 90°, 230 V				Pointer type frequency meters, 90° ^a , 230 V	Pointer type frequency meters, 240° ^a , 230 V	
	HC 48	HC 72	HC 96	HC 144	HM 45	HZC 96	HZC 144
Type							
Class	0,5				0,5	0,5	
Scale	90°				90°	240°	
a b c	48 48 86,2	72 72 69,2	96 96 69,2	144 144 91,8	85 52 65	96 96 121,2	144 144 122
45...55 Hz	[*] M12711	[*] M12721	[*] M12731	[3] M12741	[2] M12751	[1] M12831	[1] M12841

Reed type frequency meters

	HLC 72	HLC 96	HLC 144
Type			
Class	0,5		
a b c	72 72 69,2	96 96 69,2	144 144 91,8
Hz			
47...53, 13 reeds	[*] M12921	[*] M12931	[3] M12941

CODIFICATION TABLE
HC, HZC and HM frequency meters

Code	Internal code	
M 1 X X X X 0 0 X X		
	↑	↑ Delivery time
Frequency	Standard (45...55 Hz)	0 -
	57...63 Hz	1 2
	55...65 Hz	3 2
	45...65 Hz	4 2
	47...53 Hz	5 2
Voltage	Standard (230 V)	0 -
	100 ... 120 V	1 2
	380 ... 400 V	3 2
	440 V	4 2
	(*) 380 ... 440 V	6

(*) Only HC

HLC frequency meters

Code	Internal code	
M 1 X X X X 0 0 X X		
	↑	↑ Delivery time
Frequency / Num. reeds	Standard (47...53 Hz / 13 reed.)	0 -
	57...63 Hz / 13 reed.	1 2
	45...55 Hz / 11 reed.	2 2
	55...65 Hz / 11 reed.	3 2
	57...63 Hz / 7 reed.	4 2
	47...53 Hz / 7 reed.	5 2
	45...55 Hz / 21 reed.	6 2
	55...65 Hz / 21 reed.	7 2
Voltage	Standard (230 V)	0 -
	100 ... 120 V	1 2
	380 ... 400 V	3 2
	440 V	4 2

WMC / WTC / YMC / YTC, Wattmeters and varmeters



WATTMETERS, 45 ... 65 Hz

Type								
	Single-phase		Balanced three-phase		Three-phase 3 wire (ARON)		Three-phase 4 wire	
	WMC 96	WMC 144	WTC 96E	WTC 144E	WTC 96A	WTC 144A	WTC 96AN	WTC 144AN
Class	1,5							
Scale	90° P1							
	96	144	96	144	96	144	96	144
	96	144	96	144	96	144	96	144
	69,2	91,8	69,2	91,8	82,9	91,8	82,9	91,8
$U_{\text{phase-phase}}$	400 V		400 V		110 V (*)		400 V	
	[*] M13031	[4] M13041	[*] M13032	[4] M13042	[3] M13034	[3] M13044	[*] M13033	[4] M13043

Exchangeable scales for the WMC 96, WTC 96E and WTC 96AN equipment. Scales NOT included
 (*) Specify primary voltage and current of the measuring transformers, and power at full scale

Varmeters, 45 ... 65 Hz

Type								
	Single-phase		Balanced three-phase		Three-phase 3 wire (ARON)		Three-phase 4 wire	
	YMC 96	YMC 144	YTC 96E	YTC 144E	YTC 96A	YTC 144A	YTC 96AN	YTC 144AN
Class	1,5							
Scale	90 ° P1							
	96	144	96	144	96	144	96	144
	96	144	96	144	96	144	96	144
	69,2	91,8	69,2	91,8	82,9	91,8	82,9	91,8
$U_{\text{fase-fase}}$	400 V		400 V		110 V		400 V	
	[3] M13231	[3] M13241	[3] M13232	[3] M13242	[2] M13234	[3] M13244	[3] M13233	[3] M13243

Wattmeters and varmeters Exchangeable scales

Type	Single-phase			Three-phase				
		SWM 96	SYM 96		SWT 96E (*1)	SWT 96AN (*2)	SYT 96E (*1)	SYT 96AN(*2)
Equipment		WMC 96	YMC 96		WTC 96E	WTC 96AN	YTC 96E	YTC 96AN
A	Full scale	Code	Code	Full scale	Code	Code	Code	Code
50/5	20 kW	[1] M130J9	[1] M132J9	30 kW	[1] M130K9	[1] M130L9	[1] M132K9	[1] M132L9
75/5	-	-	-	50 kW	[1] M130KB	[1] M130LB	[1] M132KB	[1] M132LB
100/5	40 kW	[1] M130JC	[1] M132JC	60 kW	[1] M130KC	[1] M130LC	[1] M132KC	[1] M132LC
150/5	60 kW	[1] M130JE	[1] M132JE	90 kW	[1] M130KE	[1] M130LE	[1] M132KE	[1] M132LE
200/5	80 kW	[1] M130JF	[1] M132JF	120 kW	[1] M130KF	[1] M130LF	[1] M132KF	[1] M132LF
300/5	120 kW	[1] M130JH	[1] M132JH	180 kW	[1] M130KH	[1] M130LH	[1] M132KH	[1] M132LH
400/5	160 kW	[1] M130JJ	[1] M132JJ	240 kW	[1] M130KJ	[1] M130LJ	[1] M132KJ	[1] M132LJ
500/5	200 kW	[1] M130JK	[1] M132JK	300 kW	[1] M130KK	[1] M130LK	[1] M132KK	[1] M132LK
600/5	240 kW	[1] M130JL	[1] M132JL	360 kW	[1] M130KL	[1] M130LL	[1] M132KL	[1] M132LL
1 000/5	400 kW	[1] M130JP	[1] M132JP	600 kW	[1] M130KP	[1] M130LP	[1] M132KP	[1] M132LP
1 500/5	600 kW	[1] M130JR	[1] M132JR	900 kW	[1] M130KR	[1] M130LR	[1] M132KR	[1] M132LR
2 000/5	800 kW	[1] M130JS	[1] M132JS	1,2 MW	[1] M130KS	[1] M130LS	[1] M132KS	[1] M132LS
3 000/5	1,2 MW	[1] M130JU	[1] M132JU	1,8 MW	[1] M130KU	[1] M130LU	[1] M132KU	[1] M132LU
4 000/5	1,6 MW	[1] M130JV	[1] M132JV	2,4 MW	[1] M130KV	[1] M130LV	[1] M132KV	[1] M132LV
5 000/5	2,0 MW	[1] M130JW	[1] M132JW	3 MW	[1] M130KW	[1] M130LW	[1] M132KW	[1] M132LW

(*1) Balanced three-phase wattmeters and varmeters type WTC 93E and YTC 96E, 230 V, 400 V

(*2) Unbalanced three-phase wattmeters and varmeters type WTC 96AN and YTC 96AN, 400 V

CODIFICATION TABLE
Wattmeters and Varmeters

Code	Código interno			
M 1 X X X X 0 0 X X X				
				Delivery time
Current input	Standard ... / 5 A	0		-
	... / 1 A	1		2
Voltage	Standard (400 V _{ph-ph})	0		-
	110 V _{ph-ph} (a)	1		2
	230 V _{ph-ph}	2		2
	440 V _{ph-ph}	5		2
	460 V _{ph-ph}	6		2
	50	9		2
	75	B		2
	100	C		2
	150	E		2
	200	F		2
	300	H		2
Scale ranges	400	J		2
Primary current transformer	500	K		2
	600	L		2
	1000	P		2
	1500	R		2
	2000	S		2
	3000	U		2
	4000	V		2
	5000	W		2

(a) In ARON unbalanced three-phase Wattmeters an Varmeters (3 wires), the standard voltage is 110 V

Wattmeters and Varmeters scales

Code	Internal code			
M 1 X X X X 0 0 X X				
				Delivery time
Current input	Standard ... / 5 A	0		-
	... / 1 A	1		2
Voltages (V)	Standard (400 V)	0		-
	110 (a)	1		2
	230	2		2
	440	5		2
	460	6		2

(a) In ARON unbalanced three-phase Wattmeters an Varmeters (3 wires), the standard voltage is 110 V

FEMC / FETC / FMZ / FTC / PIC, Phasemeters

Electronic phasemeters, 90 °, 50 Hz					Electronic phasemeters, 240 °, 50 Hz			
	Single-phase		Balanced three-phase		Single-phase		Balanced three-phase	
Type	FEMC 96	FEMC 144	FETC 96	FETC 144	FMZ 96	FMZ 144	FTZ 96	FTZ 144
Class	1,5							
Scale	90° P1				240° P1			
	96	144	96	144	96	144	96	144
a	96	144	96	144	96	144	96	144
b	82,9	91,8	82,9	91,8	121,2	91,8	121,2	91,8
c								
V	cos φ 0,5-1-0,5							
100/√3	[1] M13431	[3] M13441	-	-	[4] M13531	[4] M13541	-	-
110/√3	[1] M13432	[3] M13442	-	-	[4] M13532	[4] M13542	-	-
100	[1] M13433	[3] M13443	[1] M1343C	[3] M1344C	[4] M13533	[4] M13543	[4] M1353C	[4] M1354C
110	[1] M13434	[3] M13444	[1] M1343D	[3] M1344D	[4] M13534	[4] M13544	[4] M1353D	[4] M1354D
230	[1] M13435	[3] M13445	[3] M1343E	[3] M1344E	[4] M13535	[4] M13545	[4] M1353E	[4] M1354E
400	[1] M13436	[3] M13446	[*] M1343F	[3] M1344F	[4] M13536	[4] M13546	[4] M1353F	[4] M1354F
440	[1] M13437	[3] M13447	[1] M1343G	[3] M1344G	[4] M13537	[4] M13547	[4] M1353G	[4] M1354G
500	[1] M13438	[3] M13448	[1] M1343H	[3] M1344H	[4] M13538	[4] M13548	[4] M1353H	[4] M1354H

Current range: from 0,1 to 1,2 In. To connect to .../ 5 A transformers. Electronic converter included.

Induction phasemeters 360°, 50 Hz, 4 quadrants						
	Single-phase		Balanced three-phase		Unbalanced three-phase	
Type	PIC 96 A	PIC 144 A	PIC 96 B	PIC 144 B	PIC 96 E	PIC 144 E
Class	1,5					
Scale	360°, P1					
	96	144	96	144	96	144
a	96	144	96	144	96	144
b	121,2	122	121,2	122	121,2	122
c						
V	cos φ 0-1-0					
110	[4] M13631	[4] M13641	[4] M13634	[4] M13644	[4] M13637	[4] M13647
230	[4] M13632	[4] M13642	[4] M13635	[4] M13645	[4] M13638	[4] M13648
400	[4] M13633	[4] M13643	[4] M13636	[4] M13646	[*] M13639	[4] M13649



Current range: from 0,1 to 1,2 In. To connect to .../ 5 A transformers.

CODIFICATION TABLE

Electronic phasemeters	
Code	Internal code
M 1 X X X X 0 0 X	
	↑ Delivery time
Secondary current	Standard .../ 5 A
	0 -
	.../ 1 A
	1 3

Induction phasemeters	
Code	Internal code
M 1 X X X X 0 0 X X	
	↑ Delivery time
Secondary current	Standard .../ 5 A
	0 -
	.../ 1 A
	1 3

PGR, Protection vatmeters
Protective dual bidirectional wattmeter, 230 V

				
Type	Single-phase	Balanced three-phase	Three-phase 3 wire (ARON)	Three-phase 4 wire
	PGR 96 M	PGR 96E	PGR 96A	PGR 96AN
Converter	CW-M	CW-TE	CW-TA	CW-TAN
Class	1,5			
Scale	90°, P2			
	96 96 110			
100/√3... 500 V .../ 5 A	[4] M14721	-	-	-
100...500 V .../5 A	-	[4] M14722	[4] M14724	[4] M14723

MUST SELECT THE REST OF PARAMETERS ON THE BELOW TABLE

The instrument includes the analogue converter and indicator.

Specify the primary voltage and current of the current transformers, the full scale power value and main voltage.

Included and exchangeable scales. Standardized scales.

CODIFICATION TABLE
PGR

Code		Internal code		
M 1 X X X X 0 0 X X X				
		↑	↑	↑ Delivery time
	50	9	-	-
	60	A	3	3
	75	B	3	3
	100	C	3	3
	125	D	3	3
	150	E	3	3
	200	F	3	3
	250	G	3	3
	300	H	3	3
	400	J	3	3
Scale	500	K	3	3
	600	L	3	3
	750	M	3	3
	800	N	3	3
	1000	P	3	3
	1200	Q	3	3
	1500	R	3	3
	2000	S	3	3
	2500	T	3	3
	3000	U	3	3
	4000	V	3	3
	5000	W	3	3
input current	Standard (.../ 5 A)	0	-	-
	.../ 1 A	1	3	3
Power Supply	Standard 220...240 V	0	2	2
	380 ... 400 V 40/60 Hz	3	3	3

2EC / 2HC / 2HLC / SMC / STC / UC / SynchroMAX, Synchronization and marine applications equipment

2EC, Double voltmeters

Type	2 EC 96	2 EC 144
Class	1,5	
Scale	90°	
	96 96 69,2	144 144 91,8
V		
2 x .../100	[3] M13831	[4] M13841
2 x .../110	[3] M13832	[4] M13842
2 x 220	[3] M13833	[4] M13843
2 x 380	[3] M13834	[*] M13844
2 x 440	[3] M13835	[4] M13845

Specify voltage transformers

2HC / 2HLC, Double frequencymeters

	Pointer type, 230 V		Reed type, 400 v	
Type	2 HC 96	2 HC 144		
Class	0,5		0,5	
Scale	90°		-	
	96 96 82,9	144 144 91,8	96 96 82,9	144 144 91,8
Hz			Hz	
45...55	[3] M12732	[4] M12742	47...53, 13 reeds	[*] M12932 [4] M12942

SMC / STC, Synchrosopes, 50 Hz

Type	Single-phase		Three-phase	
	SMC 96	SMC 144	STC 96	STC 144
Class	1,5		1,5	
	96 96 121,2	144 144 122	96 96 121,2	144 144 122
V				
110	[3] M14431	[4] M14441	[*] M14435	[4] M14445
230	[3] M14432	[4] M14442	[3] M14436	[4] M14446
400	[3] M14433	[4] M14443	[*] M14437	[4] M14447
500	[3] M14434	[4] M14444	[3] M14438	[4] M14448

UC / CUC, Phase sequence indicators, 50 Hz

Type	UC 72	UC 96	CUC 96
Control Relay	No		Yes
	72 72 82,9	96 96 82,9	96 96 82,9
V			
100...150	[1] M13726	[1] M13736	-
150...500	[1] M13721	[1] M13731	-
230	-	-	[3] M13754
400	-	-	[*] M13755

SynchroMAX, Synchronization equipment

Power Supply 400 V

Type		
	SynchroMAX	SynchroMAX PID
PID Control	No	Yes
	96 96 82,9	
Frequency	30 ... 70 Hz	
V Measurement		
30...150	[*] M14624	[*] M14634
110...600	[*] M14625	[4] M14635

Delivery time: [*] immediate
[x] working weeks
[c] consult

CH, Hour run meters
Hour run meters

Type	CH 48	CH 72	CH 96	CH 48
Display	5 + 2			
 a b c	48	72	96	
	48	72	96	
	86,2	69,2	69,2	
Code	[3] M14911	[3] M14921	[3] M14931	[3] M14951
EUR				

MEG-1000, Insulation resistance meter
Insulation resistance meter, 230 V (*), 50...60 Hz

Type	MEG-1000
Class	1,5
Scale	90°
Frequency	50...60 Hz
 a b c	96
	96
	132
Ω (double Scales)	0...500 kΩ 0.5...5 MΩ
Code	[*] M15051

CODIFICATION TABLE

2 EC	Internal code	
Code	M 1 X X X X 0 0 X	
		↑ Delivery time
Nominal scale value (Full scale)		
400 (640)	0	-
440 (700)	1	3
660 (1050)	2	3
1000 (1600)	3	3
1200 (1920)	4	3
2500 (4000)	5	3
3000 (4800)	6	3
3300 (5280)	7	3
4000 (6400)	8	3
5000 (8000)	9	3
5500 (8800)	A	3
6600 (10560)	B	3
7200 (11520)	C	3
9000 (14400)	D	3
10000 (16000)	E	3
11000 (17600)	F	3
12500 (20000)	G	3
15000 (24000)	H	3
20000 (32000)	J	3
22000 (35200)	K	3
24000 (38400)	L	3
25000 (40000)	M	3

2HC frequencymeters

Code	Internal code	
Code	M 1 X X X X 0 0 X X	
		↑ Delivery time
Frequency (Hz)		
Standard (45...55 Hz)	0	-
57...63	1	2
55...65	3	2
45...65	4	2
47...53	5	2
Voltage (V)		
Standard (230 V)	0	-
100 ... 120	1	3
380 ... 400	3	3
440	4	3

SMC, STC, UC

Code	Internal code	
Code	M 1 X X X X 0 0 X	
		↑ Delivery time
Frequency		
Standard (50 Hz)	0	-
60 Hz	1	3

SynchroMAX

Code	Internal code	
Code	M 1 X X X X 0 0 X	
		↑ Delivery time
Voltage supply		
Standard (400 V)	0	-
110 V	1	-
230 V	2	-
90...140 Vc.c	C	2

2HLC

Code	Internal code	
Code	M 1 X X X X 0 0 X X	
		↑ Delivery time
Frequency / No. reeds		
Standard (47...53 Hz / 13 reed.)	0	-
57...63 Hz / 13 reed.	1	2
45...55 Hz / 11 reed.	2	2
55...65 Hz / 11 reed.	3	2
Voltage		
Standard (400 V)	0	-
100 ... 120 V	1	2
440 V	4	2
380 ... 400 V	3	2
380 ... 440 V	6	2

CH

Code	Internal code	
Code	M 1 X X X X 0 0 X X	
		↑ Delivery time
Frequency		
Standard 50 Hz	0	-
60 Hz	1	2
Voltage		
Standard (230 V)	0	-
24 Vc.a.	6	2
110 Vc.a.	1	2
10...80 Vc.c.	8	2
80...200 Vc.c.	A	2



Accessories / Options for analogue instruments

GENERAL options for analogue instruments

Type	Code
IP 54 airtight seal , 48 x 48	[1] M1ZZ52
IP 54 airtight seal, 72 x 72	[1] M1ZZ53
IP 54 airtight seal, 96 x 96	[1] M1ZZ54
IP 54 airtight seal, 144 x 144	[1] M1ZZ55
Protection IP 65, 48 x 48	[1] M19941
Protection IP 65, 72 x 72	[1] M19942
Protection IP 65, 96 x 96	[1] M19943
Protection IP 65, 144 x 144	[1] M19944
Terminal covers (IP 20) 48 x 48	[3] M19921
Terminal covers (IP 20) 72x 72	[*] M19922
Terminal covers (IP 20) 96 x 96	[*] M19923

Code	Internal code		
M 1 X X X X 0 0 X X X X X			
	↑	↑	Delivery time
Tropical proof (assembly panel only)	0	1	2
Externally regulated pointer	0	2	2
Anti-reflection glass	0	3	2
Other options Makrolon glass	0	4	2
Interior lighting (6-12-48 V dc) panel only	0	5	2
Tropical proof + Anti-reflection glass	0	6	2
Tropical proof + Makrolon glass	0	7	2

Dimensions

EC / BC

EZC / ZC

Typ	Fig. EC	Fig. BC	Fig. ZC	Fig. EZC	a	b	c	d	e
48	1-3	1-3	1	-	48	44,7	61	5,2	45
72	1-3-4	2-3-4	1	1	72	67,2	43,5	5,7	68
96	1-3-4	2-3-4	1	1	96	91	43,5	5,7	92
144	2-3-4	2-3-4	1	-	144	137	64,5	7,3	138

EC-FA, EC-F, EC-FN

Type	a	b	c	d	e
72	72	67,2	43,5	5,7	68 ^{+0,8}
96	96	91	43,5	5,7	92 ^{+0,8}

EM 45 / BM 45 / MMC 45 / HM 45

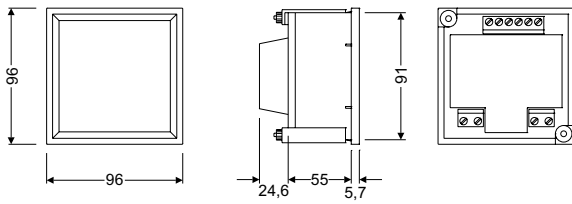
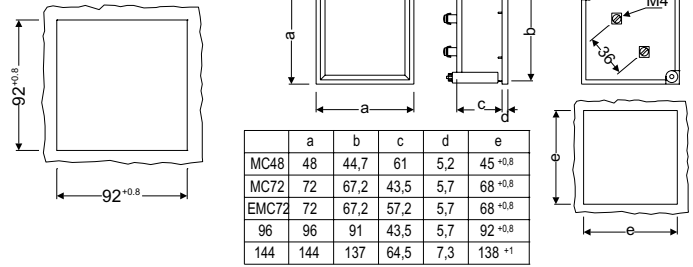
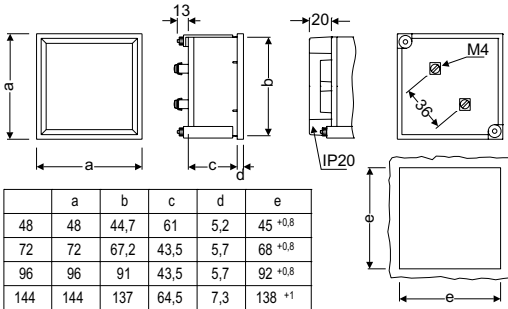
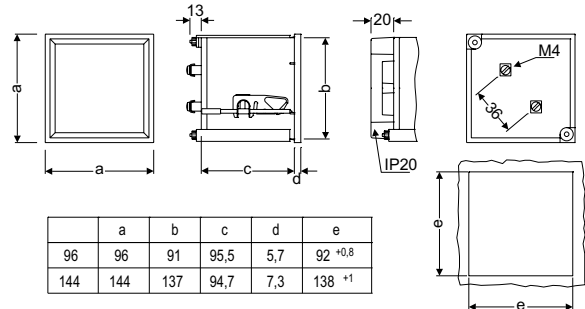
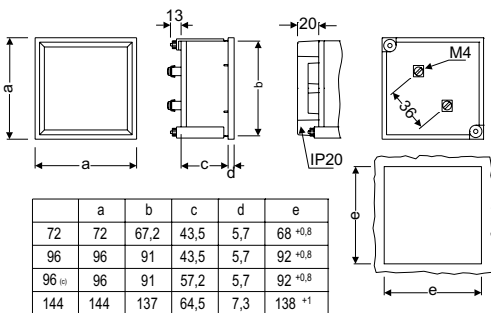
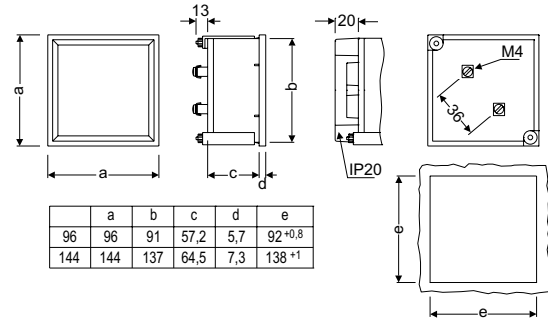
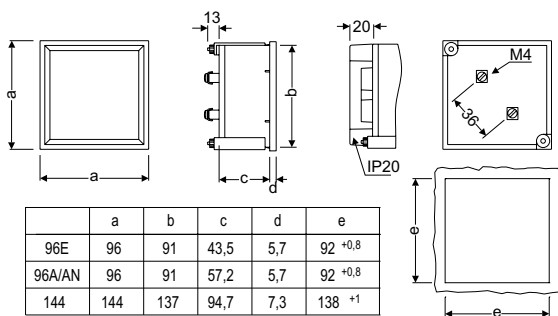
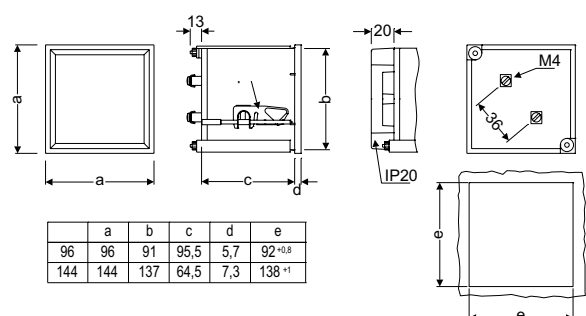
CEC / CBC / PGR

EMC / MC

HC

HZC

HLC

FEMC / FETC

WMC / YTC

FMZ / FTZ / PIC



METERING





Multifunction electrical energy meters

Table: multi-function electrical energy meters Selection	82
CIRWATT B III, Three-phase energy meters (Measuring, load profiling, multi configurable billing calendar)	83
CIRWATT B II, Single-phase energy meter	83
CIRWATT P, Prepayment energy meters	84
COMPACT DC, PRIME PLC Concentrator	84
CIRWATT B III PRIME, Three-phase energy meters with PLC system (measuring, load profiling, multi configurable billing calendar)	84
CIRWATT B II PRIME, Single-phase energy meters with PLC system (measuring, load profiling, multi configurable billing calendar)	84
CIRWATT-repeater, Repeater for amplification of the PLC signal for the PRIME system	84
PowerWat, Software for energy meters	85
LOC, Optical reader	85
ReadWatt, Impulse collection with communication	85
RS/TCP/CMBUS, Communication converters	85
Modems, Communication accessories	85
MyCLAMP, Portable clamp meter	85
kit3-TRMC210, Sets of 3 current transformers for energy meters class 0,5S	86
kit3-TRMC400, Sets of 3 current transformers for energy meters class 0,5S	86
TRMCx3, Current transformers for energy meters	86

Partial consumption energy meters

CirCAMP, Meters for managing multiple supplies	90
CIRMANAGER, Concentrator for managing the CirCAMP system	90
CirCAMP-BOX, Compact cabinets for the CirCAMP system	90
CEM, Single-phase and three-phase energy meters	91
CEM-M, Communication module	91
EDMk, Three-phase energy meters, external current transformer	91
MC3, Three-phase current transformers	91
MC1, Triple scale single-phase efficient transformers	91
CEM, Single-phase and three-phase energy meters	92
MK-DC, Direct current energy meter	92
RS/TCP/CMBUS, Communication converters	92
AIR, Wireless converters and probes	92
Modems, Communication accessories	92
PowerStudio, Energy management software	93

OUTSTANDING PRODUCTS

	CIRWATT B PRIME	COMPACT DC-S	CirCAMP	CEM-6	CEM-20 / CEM 30
					
	Three-phase energy meters	PLC PRIME Concentrator	Supply management solution	Single phase energy meter	Three-phase direct/indirect energy meters
Page	70	70	90	91	91



Multifunction electrical energy meters

Table: multi-function electrical energy meters Selection

		B502	B505	B410T	B410D	B410D RCP	B200 RCP	B100	B101	B102	P200RC	P410RC
Connection	2 wires	-	-	-	-	-	•	•	•	•	•	-
	4 wires Direct	-	-	-	•	•	-	-	-	-	-	•
	4 wires Indirect	•	•	•	-	-	-	-	-	-	-	-
	4 Quadrants	•	•	•	•	•	•	ABS	•	•	ABS	ABS
Voltage	1x230 V _{ca}	-	-	-	-	-	•	•	•	•	•	-
	3x63,5/110 V _{ca}	T	T	T	-	-	-	-	-	-	-	-
	3x127/220 V _{ca}	T	T	T	T	T	-	-	-	-	-	T
	3x230/400 V _{ca}	T	T	T	T	T	-	-	-	-	-	T
	3x127/220 V _{ca} ...3x230/400 V _{ca}	-	-	-	T	-	-	-	-	-	-	-
	3x57/100 V _{ca} ...3x230/400 V _{ca}	T	T	T	-	-	-	-	-	-	-	-
Frequency	50 Hz	T	T	T	T	T	T	T	T	T	-	-
	60 Hz	T	T	T	T	T	T	T	T	T	-	-
	50/60 Hz	-	T	T	T	-	-	-	-	-	•	•
Communications	RS-485	-	-	-	-	-	-	-	-	•	-	-
	PRIME	-	-	-	-	•	•	-	-	-	-	-
	RS-232/232	T	T	T	T	-	-	-	-	-	-	-
	RS-232/485	T	T	T	T	-	-	-	-	-	-	-
	RS-232/Ethernet	T	T	T	T	-	-	-	-	-	-	-
	RS-485/Ethernet	T	T	T	T	-	-	-	-	-	-	-
	RFID	-	-	-	-	-	-	-	-	-	•	•
Input / Output modules	Impulse output	-	-	-	-	-	-	-	T	T	-	-
	Relay output	-	-	-	-	T	T	-	-	T	-	-
	Tariff selection input	-	-	-	-	-	-	-	T	T	-	-
	Auxiliary power supply	OP	OP	OP	OP	-	-	-	-	-	-	-
	4 relay outputs	OP	OP	OP	OP	-	-	-	-	-	-	-
	4 I / 2 O relay	OP	OP	OP	OP	-	-	-	-	-	-	-
Circuit breaker	2 I / 2 O relay / 2 O	OP	OP	OP	OP	-	-	-	-	-	-	-
		-	-	-	-	•	•	-	-	-	•	•
Page		83	83	83	83	84	84	83	83	83	84	84

OP - Optional / T - According to type



CIRWATT B III, Three-phase energy meters (Measuring, load profiling, multi configurable billing calendar)

Type	Code	Class (Active/ Reactive)	Quadrants	Measurement Range (V)	Measurement Range (A)	Frequency (Hz)	Communications
CIRWATT B 502							
402-VT5A-90B10	[1] QBL10	0.2S/0.5	4	3x57/100 ... 3x230/400	.../ 5 A	50	RS-232 / RS-485
402-VT5A-A0B10	[1] QBL20	0.2S/0.5	4	3x57/100 ... 3x230/400	.../ 5 A	50	RS-232 / Ethernet
402-VT5B-90B10	[1] QBL50	0.2S/0.5	4	3x57/100 ... 3x230/400	.../ 5 A	60	RS-232 / RS-485
402-VT5B-A0B10	[1] QBL60	0.2S/0.5	4	3x57/100 ... 3x230/400	.../ 5 A	60	RS-232 / Ethernet
CIRWATT B 505							
405-VT5A-90B10	[1] QBK10	C (0,5S)/1	4	3x57/100 ... 3x230/400	.../ 5 A	50	RS-232 / RS-485
405-VT5A-A0B10	[1] QBK20	C (0,5S)/1	4	3x57/100 ... 3x230/400	.../ 5 A	50	RS-232 / Ethernet
405-VT5B-90B10	[1] QBK50	C (0,5S)/1	4	3x57/100 ... 3x230/400	.../ 5 A	60	RS-232 / RS-485
405-VT5B-A0B10	[1] QBK60	C (0,5S)/1	4	3x57/100 ... 3x230/400	.../ 5 A	60	RS-232 / Ethernet
405-VT7A-90B10	[1] QBN00	C (0,5S)/1	4	3x57/100 ... 3x230/400	.../ 1 A	50	RS-232 / RS-485
405-VT7A-A0B10	[1] QBN10	C (0,5S)/1	4	3x57/100 ... 3x230/400	.../ 1 A	50	RS-232 / Ethernet
405-VT7B-A0B10	[1] QBN30	C (0,5S)/1	4	3x57/100 ... 3x230/400	.../ 1 A	60	RS-232 / RS-485
410-VT7B-A0B10	[1] QBN40	C (0,5S)/1	4	3x57/100 ... 3x230/400	.../ 1 A	60	RS-232 / Ethernet
CIRWATT B 410T							
410-QT5A-90B10	[1] QB870	B (1) / 2	4	3x230/400	.../ 5 A	50	RS-232 / RS-485
410-QT5A-A0B10	[1] QB880	B (1) / 2	4	3x230/400	.../ 5 A	50	RS-232 / Ethernet
410-QT5A-90B10	[1] QBJ10	B (1) / 2	4	3x57/100 ... 3x230/400	.../ 5 A	50	RS-232 / RS-485
410-VT5A-A0B10	[1] QBJ20	B (1) / 2	4	3x57/100 ... 3x230/400	.../ 5 A	50	RS-232 / Ethernet
410-QT5B-90B10	[1] QB8D0	B (1) / 2	4	3x230/400	.../ 5 A	60	RS-232 / RS-485
410-QT5B-A0B10	[1] QB8E0	B (1) / 2	4	3x230/400	.../ 5 A	60	RS-232 / Ethernet
410-VT5B-90B10	[1] QBJ60	B (1) / 2	4	3x57/100 ... 3x230/400	.../ 5 A	60	RS-232 / RS-485
410-VT5B-A0B10	[1] QBJ70	B (1) / 2	4	3x57/100 ... 3x230/400	.../ 5 A	60	RS-232 / Ethernet
410-QT7A-90B10	[1] QBN0B	B (1) / 2	4	3x230/400	.../ 1 A	50	RS-232 / RS-485
410-QT7A-A0B10	[1] QBN1B	B (1) / 2	4	3x230/400	.../ 1 A	50	RS-232 / Ethernet
410-VT7A-90B10	[1] QBN0J	B (1) / 2	4	3x57/100 ... 3x230/400	.../ 1 A	50	RS-232 / RS-485
410-VT7A-A0B10	[1] QBN1J	B (1) / 2	4	3x57/100 ... 3x230/400	.../ 1 A	50	RS-232 / Ethernet
410-QT7B-90B10	[1] QBN2B	B (1) / 2	4	3x230/400	.../ 1 A	60	RS-232 / RS-485
410-QT7B-A0B10	[1] QBN3B	B (1) / 2	4	3x230/400	.../ 1 A	60	RS-232 / Ethernet
410-VT7B-90B10	[1] QBN2J	B (1) / 2	4	3x57/100 ... 3x230/400	.../ 1 A	60	RS-232 / RS-485
410-VT7B-A0B10	[1] QBN3J	B (1) / 2	4	3x57/100 ... 3x230/400	.../ 1 A	60	RS-232 / Ethernet
CIRWATT B 410D							
410-QD1A-90B00	[1] QB4B0	B (1) / 2	4	3x230/400	10 (100)	50	RS-232 / RS-485
410-QD1A-A0B00	[1] QB4C0	B (1) / 2	4	3x230/400	10 (100)	50	RS-232 / Ethernet
410-QD1B-A0B10	[1] QB4H0	B (1) / 2	4	3x230/400	10 (100)	60	RS-232 / RS-485
410-QD1B-A0B10	[1] QB4I0	B (1) / 2	4	3x230/400	10 (100)	60	RS-232 / Ethernet

Please contact us for other configurations (Inputs, outputs and other communications)

CIRWATT B II, Single-phase energy meter

Type	Code	Class (Active/ Reactive)	Qua- drants	Measu- ment Range (V)	Measu- ment Range (A)	Fre- quency (Hz)	Tariff	Impulse output	Output relay	Change tariff input	Certifi- cation	Communications
CIRWATT B100												
210-ES7A-00B20	[1] QBM00M20	B (1)	Abs.	230	5 (65)	50	1	-	-	0	MID	-
210-ES7A-00B20	[1] QBM00M21	1	Abs.	230	5 (65)	50	1	-	-	0	IEC	-
210-ES7A-00B20	[1] QBM00M23	1	Abs.	230	5 (65)	50	1	-	-	0	IEC	-
210-ES7B-00B20	[1] QBM20M20	B (1)	Abs.	230	5 (65)	60	1	-	-	0	MID	-
210-ES7B-00B20	[1] QBM20M21	1	Abs.	230	5 (65)	60	1	-	-	0	IEC	-
210-ES7B-00B20	[1] QBM20M23	1	Abs.	230	5 (65)	60	1	-	-	0	IEC	-
CIRWATT B101												
210-ES4A-01B20	[1] QBM03	B (1)	Abs.	230	5 (65)	50	3	1	-	0	IEC	-
210-ES4A-0EB20	[1] QBM07	B (1)	Abs.	230	5 (65)	50	2	-	-	1	IEC	-
CIRWATT B102												
212-ES7A-21B20	[1] QBM83	B (1) / 2	Abs.	230	5 (65)	50	3	1	-	0	IEC	RS-485 (IEC)
212-ES7A-23B20	[1] QBM85	B (1) / 2	Abs.	230	5 (65)	50	3	-	1	0	IEC	RS-485 (IEC)
212-ES7A-2EB20	[1] QBM87	B (1) / 2	Abs.	230	5 (65)	50	2	-	-	1	IEC	RS-485 (IEC)

ABS. Storage of generated and consumed energy. (*1) Laser engraved, in English / (*2) Laser engraved, in Spanish Please contact us for other configurations (inputs, outputs and other communications)

OPTIONAL
ACCESSORIES
(additional price)

Code	Model	Description
Consult	3	4 output relays 3 A, 250 Vac
Consult	5	4 impulse inputs, 2 output relays 3 A, 250 Vac
Consult	D	2 output relays 3 A 250 Vac, 2 impulse inputs, 2 impulse outputs
Consult	6	Auxiliary Power Supply 24-48Vdc
Consult	B	Earth leakage detection

Delivery time: [*] immediate
[x] working weeks
[c] consult

**CIRWATT P, Prepayment energy meters**

Type	Code	Class (Active/Reactive)	Quadrants	Measurement Range (V)	Measurement Range (A)	Frequency (Hz)	Discon. relay	Communications
212-WS4C-23P23	[C] QP102	1 / 2	4	110 ... 260	10 (60)	50 / 60	*	RFID
410-QD1C-20P22	[C] QP302	1 / 2	4	230 / 400	10 (100)	50 / 60	*	RFID

Type	Code	Description
PEM-SOFT_PLUS	[C] Q30501.	Management software + PEM-TERM
PEM-TERM	[C] Q31100.	PEM-CARD writer / reader
PEM-CARD	[C] E20001.	RFID card for universal dispenser

NEW**COMPACT DC, PRIME PLC Concentrator**

Type	Code	Digital inputs	Communications	LV supervisor	2° transformer connection	Measure VN-GND	Size (mm) width xheight xdepth
Compact DC-S 3G	[1] Q46210.	-	PRIME / 3G	*	-	-	203x120x130
Compact DC-S 4I	[1] Q46220.	4	PRIME	*	-	-	203x120x130
Compact DC-S SBT	[1] Q46230.	-	PRIME	*	-	-	165x120x130
Compact DC-S BASIC	[1] Q46240.	-	PRIME / 3G	-	-	-	165x120x130
Compact DC-S 2	[1] Q46250.	4	PRIME	*	*	-	279x120x130
Compact DC-S 3G VTN	[1] Q46211.	-	PRIME / 3G	*	-	1	241x120x130
Compact DC-S 4I VTN	[1] Q46221.	4	PRIME	*	-	1	241x120x130
Compact DC-S SBT VTN	[1] Q46231.	-	PRIME	*	-	1	203x120x130
Compact DC-S BASIC VTN	[1] Q46241.	-	PRIME / 3G	-	-	1	203x120x130
Compact DC-S 2 VTN	[1] Q46251.	4	PRIME / 3G	2	*	1	317x120x130

Isolated digital inputs, 10 kV/1 min

CIRWATT B III PRIME, Three-phase energy meters with PLC system (measuring, load profiling, multi configurable billing calendar)

Type	Code	Class (Active/Reactive)	Quadrants	Measurement Range (V)	Measurement Range (A)	Frequency (Hz)	Output relay	Discon. relay	Communications
CIRWATT B 410TP, indirect connection									
410-QT5A-B0B10	[1] QB810	B (1) / 2	4	3x230/400	... / 5 A	50	0	-	RS-232 / PRIME
CIRWATT B 410DP, direct connection									
410-QD1A-B0B10	[1] QB4N0	B (1) / 2	4	3x230/400	10 (100)	50	0	-	RS-232 / PRIME
CIRWATT B 410RCP, direct connection with internal disconnection relay									
410-QD1A-B0B16	[C] QB4P0	B (1) / 2	4	3x230/400	10 (100)	50	0	*	- / PRIME
410-QD1A-B3B16	[C] QB4P1	B (1) / 2	4	3x230/400	10 (100)	50	1	*	- / PRIME

CIRWATT B II PRIME, Single-phase energy meters with PLC system (measuring, load profiling, multi configurable billing calendar)

Type	Code	Class (Active/Reactive)	Quadrants	Measurement Range (V)	Measurement Range (A)	Frequency (Hz)	Output relay	Discon. relay	Communications
212-ES4A-B0B17	[1] QB3C0	B / 2	4	230	10 (60)	50	0	*	PRIME
212-ES4A-BFB-17	[1] QB3C3	B / 2	4	230	10 (60)	50	1	*	PRIME

Please contact us for other configurations (Inputs, outputs and other communications)

NEW**CIRWATT-repeater, Repeater for amplification of the PLC signal for the PRIME system**

Type	Code	Description
CIRWATT Repeater	[C] QM4011.	Three-phase repeater to amplify the PLC system of the PRIME system

**PowerWatt/SoftWatt, Software for energy meters**

Type	Code	Description
PowerWatt LT SQL	[*] Q30423.	Energy metering management information software

**LOC, Optical reader**

Type	Code	Description
Loc	[*] Q30301.	CIRWATT optical reader
Loc-USB	[*] Q30302.	CIRWATT optical reader with USB port

**ReadWatt, Impulse collection with communication**

Type	Code	Description
ReadWatt	[*] M62311.	Impulse collector with RS232/RS485 Modbus communications. Built in transistor output. PowerStudio supported
PS 100..240Vcc	[*] M62331.	ReadWatt power supply

**RS/TCP/CMBUS, Communication converters**

Type	Code	Description
RS2RS	[*] M62141.	RS-232/485 Intelligent converter and amplifier (RTS control) for PC
USB-RS 485	[*] M54040.	USB to RS-485 Converter
USB-RS 232	[*] M54050.	USB to RS-232 Converter
TCP1RS+	[*] M62121.	RS-485 / Ethernet modbus/TCP Converter
TCP2RS+	[*] M54033.	RS-232/485 Converter / Ethernet Modbus/TCP. Built-in web server and web set-up
CMBUS-8	[*] M540A0.	M-Bus to Modbus Converter, up to 8 Mbus slaves
CMBUS-24	[*] M540B0.	M-Bus to Modbus Converter, up to 24 Mbus slaves

Modems, Communication accessories

Type	Code	Description
M-GSM 10 BITS	[*] Q30213IB00000	GSM RS-232/485 Modem (includes antenna + cable). Parameterisation with even parity (10 bits)
M-GSM 11 BITS	[*] Q30213EN00000	GSM RS-232/485 Modem (includes antenna + cable). Parameterisation with even parity (11 bits)
SGE-3G/GPRS	[*] Q30230.	GPRS-3G Modem with Ethernet communications (includes PS + antenna + cable)
ANTENA GSM UT-35 9db	[1] Q4994E.	Antenna 9 db (for GSM modem)

**MyCLAMP, Portable clamp meter**

Type	Code	Description	Measurement Range (A)	Usefull diam.(mm)
MyCLAMP BT	[C] Q31400.	Portable current clamp for Low Voltage networks 50-60 Hz (air connection)	2...125 A	25
P-64	[C] Q39970.	Insulating pole for Low Voltage cables. 6,4 m (1,6 m refoated)	-	-

NEW

kit3-TRMC210, Sets of 3 current transformers for energy meters class 0,5S

Type	kit3-TRMC210			kit3-TRMC210-05			kit3-TRMC210-05S-2		
	width x height x depth (mm) 145x111x80								
A/V-A	Class	VA	Code	Class	VA	Code	Class	VA	Code
100/5	0.5S	10	[3] Q309010100000	0.5	10	[3] Q309610100000	0.5S	2,5	[3] Q309810100000
150/5	0.5S	10	[3] Q309020100000	0.5	10	[3] Q309620100000	0.5S	2,5	[3] Q309820100000
200/5	0.5S	10	[3] Q309030100000	0.5	10	[3] Q309630100000	0.5S	2,5	[3] Q309830100000
300/5	0.5S	10	[3] Q309040100000	0.5	10	[3] Q309640100000	0.5S	2,5	[3] Q309840100000
400/5	0.5S	10	[3] Q309050100000	0.5	10	[3] Q309650100000	0.5S	2,5	[3] Q309850100000
500/5	0.5S	10	[3] Q309060100000	0.5	10	[3] Q309660100000	0.5S	2,5	[3] Q309860100000
600/5	0.5S	10	[3] Q309070100000	0.5	10	[3] Q309670100000	0.5S	2,5	[3] Q309870100000

kit3-TRMC400, Sets of 3 current transformers for energy meters class 0,5S

Type	kit3-TRMC400			kit3-TRMC400-05			kit3-TRMC400-05-2		
	width x height x depth (mm) 99x160x68								
Flat strip(mm)	100x20 mm								
A/V-A	Class	VA	Code	Class	VA	Code	Class	VA	Code
750/5	0.5S	10	[3] Q309110100000	0.5	10	[3] Q309710100000	0.5	2,5	[3] Q309A10100000
1000/5	0.5S	10	[3] Q309120100000	0.5	10	[3] Q309720100000	0.5	2,5	[3] Q309A20100000
1500/5	0.5S	10	[3] Q309130100000	0.5	10	[3] Q309730100000	0.5	2,5	[3] Q309A30100000
2000/5	0.5S	10	[3] Q309140100000	0.5	10	[3] Q309740100000	0.5	2,5	[3] Q309A40100000
3000/5							0.5	2,5	[3] Q309A60100000



TRMCx3, Current transformers for energy meters

Type	Code	Measurement Range (A)	Class 0,5S Power (VA)	Usefull diam.(mm)	Cable (m)
Indoor					
TRMC-x3 100/5	[*] Q301T1.	100/5	2,5	38	1.5
TRMC-x3 200/5	[*] Q301T2.	200/5	2,5	38	1.5
TRMC-x3 300/5	[*] Q301T3.	300/5	2,5	38	1.5
TRMC-x3 400/5	[*] Q301T4.	400/5	2,5	38	1.5
Outdoor					
TRMC-X3 100/5 Ext	[C] Q301T1010E000	100/5	2,5	38	7
TRMC-X3 200/5 Ext	[C] Q301T2010E000	200/5	2,5	38	7
TRMC-X3 300/5-ext	[C] Q301T3010E000	400/5	2,5	38	7
TRMC-X3 400/5 Ext	[C] Q301T4010E000	300/5	2,5	38	7

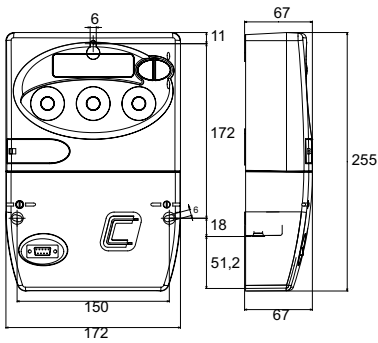

Dimensions

CIRWATT B502 /505 / 410T / 410D



CIRWATT B 101 / 102 /200 RC / 200 RCP

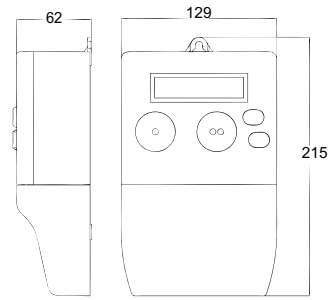
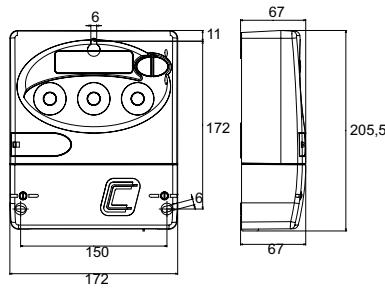

CIRWATT B 410 RCP

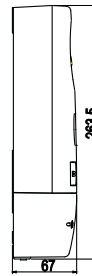
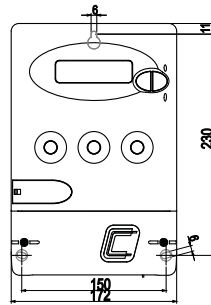
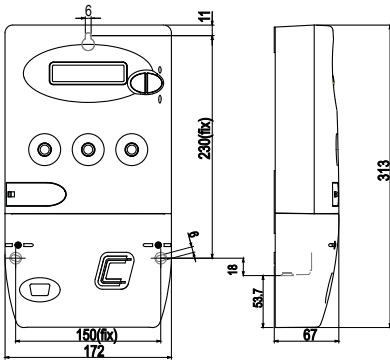

CIRWATT B100

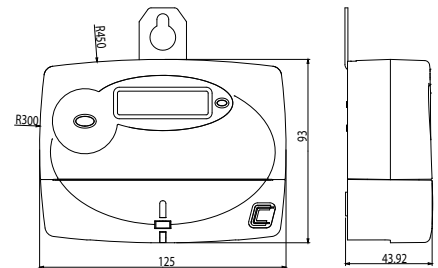

Compact DC + SBT

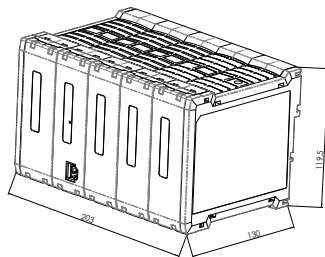
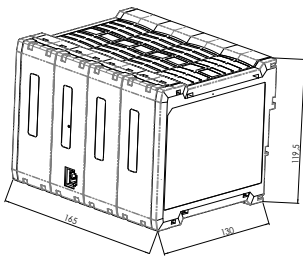

SGE 3G/GPRS

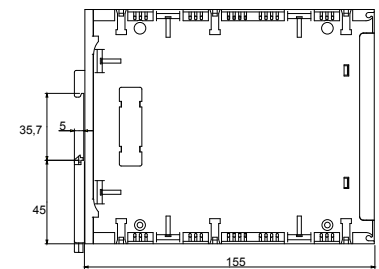
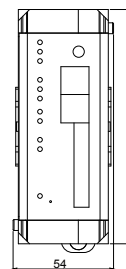

CMBT COMPACT PRIME CT6 / CT7 / 8D

CMBT COMPACT PRIME CT6A / CT7A

CMBT COMPACT PRIME CT8

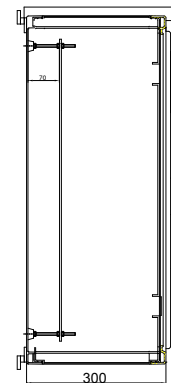
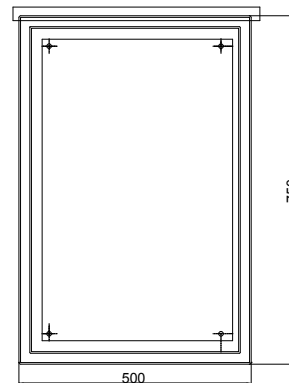
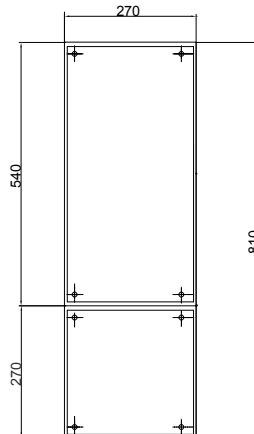
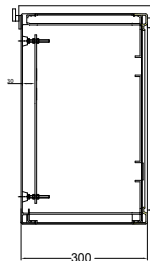
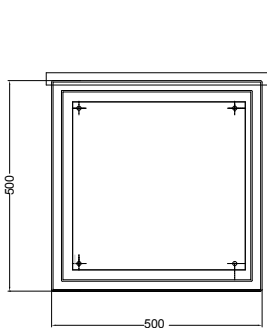

SELECTION TABLE - SINGLE-PHASE ENERGY METERS

CIRWATT [] [] [] [] - [] [] [] [] - [] [] x [] - [] []

Energy Meter Type	CIRWATT B101/102	CIRWATT B200RC	CIRWATT B200RCP		
Asymmetric connection 2-wire	•	•	•	2	
Class B (1) active / not measure reactive	•	•	-	10	Accuracy
Class B (1) active / class 2.0 reactive	• (102)	-	•	12	
1x230 V _{ac}	•	-	•	E	Voltage measure
1x127 V _{ac}	•	-	•	B	
1x120 V _{ac}	•	-	•	1	
1X110...260 V _{ac}	-	•	-	W	
Shunt 10 (60) A	-	•	•	S4	Current measure
Shunt 5 (65) A	•	-	-	S7	
50 Hz	•	-	•	A	Frequency
60 Hz	•	-	•	B	
50 / 60 Hz	-	•	-	C	
Without communications	• (101)	-	-	0	Comm.
Port R1	RS-485 (102)	RS-485 /RFID	-	2	
Port R1	-	-	DCSK A	4	
Port R1	-	-	DCSK B	5	
Port R1	-	-	PRIME	B	
Without inputs / outputs	-	-	•	0	Expansion modules
Inputs / output	Input 100 to 240 VAC	-	-	E	
Inputs / output	Optomos output	-	-	1	
Inputs / output	1 relay output 3 A 250 V, potential-free	1 relay output 3 A 250 V, neutral potential	-	3	
Inputs / output	-	-	1 relay output 3 A 250 V, potential-free	F	
Domestic / residential / small industry	•	-	•	B	Type
Prepayment	-	•	-	P	
2 Quadrants	• (OP)	-	-	0	Register mode
4 Quadrants	•	-	•	1	
Bidirectional with always positive register	• (OP)	•	-	2	
Without other features	•	-	-	0	Other features
With omnipolar circuit breaker	-	•	•	3	
Neutral current measurement and magnetic detection	• (OP)	-	-	5	
With omnipolar cutting element and voltage fraud detection	-	-	•	7	

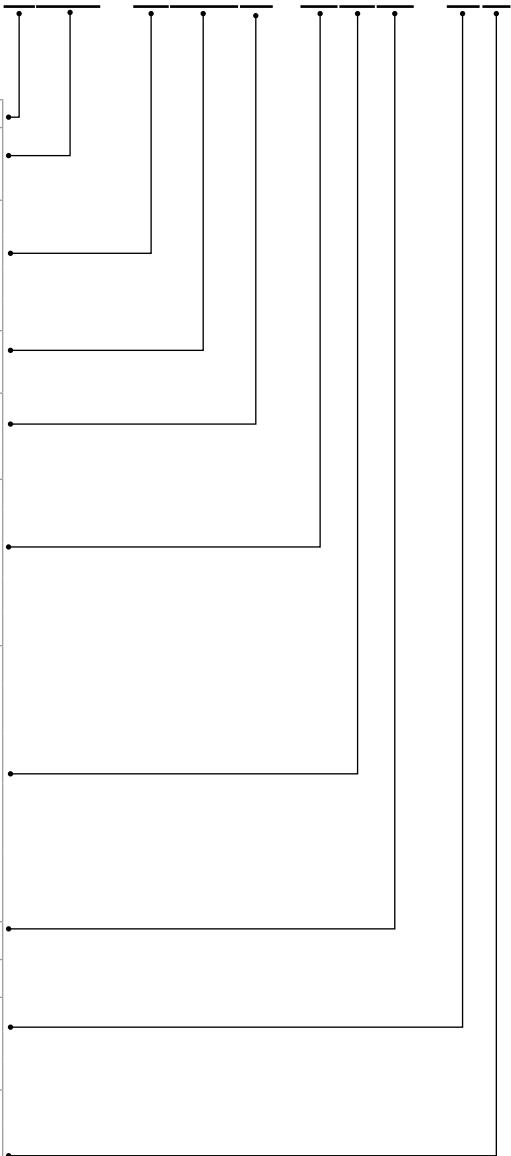











SELECTION TABLE - THREE-PHASE ENERGY METERS

TIPO DE CONTADOR	CIRWATT B410D	CIRWATT B502 / B505 / B410T / B410TP	CIRWATT B400RCP	CIRWATT B400RC		CIRWATT													
4-wire	•	•	•	•	4	Connection mode													
Class 0.2s Active	-	•	-	-	02	Accuracy													
Class 0.5 Reactive	-	•	-	-	05														
Class (C) 0.5s Active	-	•	-	-	10														
Class 1 Reactive	•	•	•	•															
Class (B) 1 Active	•	•	•	•		Voltage measure													
Class 2.0 Reactive	•	•	•	•															
3 x 57 / 100 V _{ac}	-	•	-	-	L														
3 x 63.5 / 110 V _{ac}	-	•	-	-	M														
3 x 127 / 220 V _{ac}	•	•	•	-	N														
3 x 230 / 400 V _{ac}	•	•	•	•	Q														
3 x 57/100 V _{ac} ... 3 x 230 / 400 V _{ac}	-	•	-	-	V														
Transformer 2,5 (10) A	-	•	-	-	T2	Current measure													
Transformer 5 (10) A	-	•	-	-	T5														
Transformer 1 (6) A	-	•	-	-	T7														
Transformer 1 (10) A	-	•	-	-	T8														
Direct 10 (100) A	•	•	•	-	D1														
Direct 15 (120) A	•	-	-	-	D5														
Direct 5 (100) A	•	-	-	-	D6														
50 Hz	•	•	•	-	A	Frequency													
60 Hz	•	•	•	-	B														
Automatic (50 / 60 Hz)	•	•	-	•	C														
Without communications	•	•	-	-	0	Comm.													
R1 / R2	RS485 / PLC A	RS485 / PLC A	-	RS485 / RFID	2														
R1 / R2	RS232 / PLC A	RS232 / PLC A	PLC A	-	4														
R1 / R2	RS232 / PLC B	RS232 / PLC B	PLC B	-	5														
R1 / R2	RS232 / RS232	RS232 / RS232	-	-	7														
R1 / R2	RS232 / RS485	RS232 / RS485	-	-	9														
R1 / R2	RS232 / Ether.	RS232 / Ether.	-	-	A														
R1 / R2	RS232 / PRIME	RS232 / PRIME	PRIME	-	B														
R1 / R2	RS485 / Ether.	RS485 / Ether.	-	-	C														
Without inputs / outputs	•	•	•	-	0	Expansion modules													
inputs / outputs	Relé 3A 250V libre potencial	Relé 3A 250V libre potencial	Relé 3A 250V libre potencial	-	3														
inputs / outputs	*1	*1	-	-	5														
inputs / outputs	Alim. auxiliar	Alim. auxiliar	-	-	6														
inputs / outputs	*2	*2	-	-	A														
inputs / outputs	Fuga Tierra	Fuga Tierra	-	-	B														
inputs / outputs	*3	*3	-	-	D														
Domestic / residential / small industry	•	•	•	-	B	Type													
Prepayment	-	-	-	•															
2 Quadrants	•	•	•	-	0	Quadrants													
4 Quadrants	•	•	•	-	1														
Accumulation in both ways	•	•	-	•	2														
No special features	•	•	•	-	0	Additional features													
With circuit breaker in the phase line	-	-	•	-	2														
With omnipolar circuit breaker	-	-	•	•	3														
With circuit breaker in the phase line and detection of tension fraud	-	-	•	-	6														
*1 - 2 Relay outputs, 4 optocoupled inputs																			
*2 - 4 optocoupled inputs																			
*3 - 2 Relay outputs, 2 pulse inputs, 2 optocoupled outputs																			



Partial consumption energy meters

Table: Selection of partial consumption electrical energy meters

		CEM-6	MK DC	CEM-10	CEM-20	CEM-30	EDMK	CirCAMP-4DP	CirCAMP-2IP
									
Mounting	DIN rail (modules)	1	2	2	4	4	3	11	11
DC measurement		-	•	-	-	-	-	-	-
AC measurement	Three-phase 3/4 wires	-	-	-	•	•	•	•	•
	Single-phase	•	•	•	-	-	-	•	-
	Quadrants	2	2	2, 4 or ABS	2, 4 or ABS	2, 4 or ABS	4	2	2
Parameters	Active energy (kWh)	•	•	•	•	•	•	•	•
	Reactive energy (kvarh)	•	-	•	•	•	•	-	-
	V, A, W, Hz,FP	•	•	•	•	•	-	•	•
	Tariffs	1	1	1	1	1	1 / 3 - ST	-	-
Current Input	Direct	5 (10) A	30 Acc - ST	5 (65) A	5 (65) A	-	-	5 (32) A	-
	Indirect	-	ST	-	-	/ 5 A	ST	-	/ 5 A
	MC System	-	-	-	-	-	ST	-	-
Communications	RS-485	•	-	OP	OP	OP	ST	-	-
	Ethernet	-	-	OP	OP	OP	-	-	-
	PLC (OFDM)	-	-	-	-	-	-	•	•
Inputs/outputs	Digital inputs	-	-	-	-	-	-	4	2
	Digital outputs	1	-	1	1	1	1/2	-	-
	Relay outputs	-	-	-	-	-	-	4	4
Optional	MID certification	-	-	ST	ST	ST	ST	-	-
	Auxiliary power supply	-	•	-	•	•	•	-	-
Page		92	92	91	91	91	91	90	90

DT - Depending on the type/ OP - Optional



CirCAMP, Meters for managing multiple supplies

Type	Code	Measurement Range (A)	System	Output relay	Digital inputs	Communications	Work mode
CirCAMP-4DP	[C] QM4000.	32	4 single-phase or 1 three-phase	4	4	PLC	Post-pay/prepay
CirCAMP-2IP	[C] QM4001.	.../5	2 indirect three-phase	4	2	PLC	Post-pay/prepay



CirMANAGER, Concentrator for managing the CirCAMP system

Type	Code	Energy measurement (SBT)	Measurement Range (A)	Communications	Size (mm) width xheight xdepth
CirMANAGER SBT	[C] Q47001.	kWh	.../5 A	-	165x120x130
CirMANAGER SBT 3G	[C] Q47009.	kWh	.../5 A	3G	203x120x130

Tipo	Código	Descripción
CirCAMP Repeater	[C] QM4010.	Repetidor trifásico para la amplificación de la señal PLC para sistema el CirCAMP

CirCAMP-BOX, Compact cabinets for the CirCAMP system

Type	Code	Electric supply	Water supply
CirCAMP-BOX 44	[C] QM4021.	4	4
CirCAMP-BOX 40	[C] QM4022.	4	-
CirCAMP-BOX 22	[C] QM4023.	2	2
CirCAMP-BOX 20	[C] QM4024.	2	-
CirCAMP-BOX-60	[C] QM4025.	6	-
CirCAMP-BOX-80	[C] QM4026.	8	-



CEM, Single-phase and three-phase energy meters

Type	Code	Measurement Range (V)	Input current	Frequency (Hz)	System	Power supply	Certification	Measure
CEM C10 212	[*] Q21112.	1 x 230	5 (65) A	50/60	Single-phase	-	IEC	Direct
CEM C10 212 MID	[*] Q21114.	1 x 230	5 (65) A	50/60	Single-phase	-	MID	Direct
CEM C20 312	[*] Q22312.	3x127/220... 3x 230/400	5 (65) A	50/60	Three-phase	230 Vac	IEC	Direct
CEM C20 312 MID	[*] Q22314.	3x127/220... 3x 230/400	5 (65) A	50/60	Three-phase	230 Vac	MID	Direct
CEM C30 312	[*] Q23422.	3x127/220... 3x 230/400	.../ 5 (6) A	50/60	Three-phase	230 Vac	IEC	Indirect
CEM C30 312 MID	[*] Q23424.	3x127/220... 3x 230/400	.../ 5 (6) A	50/60	Three-phase	230 Vac	MID	Indirect

CEM-M, Communication module

Type	Code	Communications	Protocol
CEM-M-RS485	[*] Q23100.	RS-485	Modbus
CEM-M-ETH	[C] Q23400.	Ethernet	Modbus-TCP



EDMk, Three-phase energy meters, external current transformer

Type	Code	Tariff	Transistor output	Communications	Módulos	Units
230 Vac supply - To other values see codification table						
EDMK-ITF-RS485-C2	[*] M31751.	1	2	RS-485	3	kWh, kvarLh, kvarCh
MID						
EDMk-MID-ITF-RS485-C	[*] M317C4.	1	1	RS-485	3	kWh, kvarLh, kvarCh
EDMK-MC-ITF-RS485-C2	[*] M31781.	1	2	RS-485	3	kWh, kvarLh, kvarCh



MC3, Three-phase current transformers

Type	Code	A (max.)	Class 0,5 Power (VA)	System	Usefull diam.(mm)
MC3 - 63 A	[*] M73121.	63	0,1	Three-phase	7,1
MC3 - 125 A	[*] M73122.	125	0,1	Three-phase	14,6
MC3 - 250 A	[*] M73123.	250	0,1	Three-phase	26



MC1, Triple scale single-phase efficient transformers

Type	Code	Measurement Range (A)	A (max.)	Class 0,5 Power (VA)	System	Usefull diam.(mm)
MC1-15-75	[*] M73112.	75	75	0,25	Single-phase	15
MC1-20-50/100/150 A	[*] M73118.	50/100/150	150	0,25	Single-phase	20
MC1-35-50/100/150 A	[*] M73116.	50/100/150	150	0,25	Single-phase	35
MC1-20-150/200/250 A	[*] M73113.	150/200/250	250	0,25	Single-phase	20
MC1-30-250/400/500 A	[*] M73114.	250/400/500	500	0,25	Single-phase	30
MC1-55-500/1000/1500 A	[*] M73115.	500/1000/1500	1500	0,25	Single-phase	55
MC1-80 1000/1500/2000 A	[*] M73117.	1000/1500/2000	2000	0,25	Single-phase	80

CODIFICATION TABLE

CEM		Q	2	X	X	X	X	0	0	X	X	X	X	X	Delivery time
Code	Internal code														
	Meas.V	Standard (1x230 V)	0												-
Current input	CEM10	1x127 V _{ac}	1												2
	CEM 10	Standard (5 (65) A)	0												-
	CEM 20	10 (60) A	1												2
Energy measure	CEM 30	Standard (5 (6) A)	0												-
		5 (10) A	1												2
Quadrants	Standard (Active+reactive)	0													-
	Active	1													2
Quadrants	Standard (ABS)	0	0												-
		2		0	1	2									2
Quadrants		4		0	2	2									2

EDMk		M	3	X	X	X	X	0	0	X	0	0	X	X	Delivery time
Code	Internal code														
	Power supply voltage	Standard (230 V _{ac})	0												-
Power supply voltage	85...265 V _{ac}									C					1
	95...300 V _{dc}														-
Others	Standard (without battery)									0	0				-
	With battery (it is used to read energy meters only in event of no mains supply)									3	0				1

NEW
CEM, Single-phase and three-phase energy meters

Type	Code	Measurement Range (V)	Input current	System	Transistor output	Communications	Measure
CEM-C6	[*] Q26112.	1 x 230	10 (100) A	Single-phase	1	RS-485	Direct

MK-DC, Direct current energy meter

Type	Code	Measurement Range (V)	Tariff	Módulos	Measure	Units	Display
MK30-DC	[3] M30300.	0...800	1	1	30 Adc	V, A, kW, kWh	LED
MK-SH-DC	[*] M30400.	0...800	1	1	.../ 60 mV (*)	V, A, kW, kWh	LED
MK-30-DC M:125Vcc	[3] M303000000D00	0...125	1	1	30 Adc	V, A, kW, kWh	LED
MK-SH-DC M:125Vcc	[3] M304000000D00	0...125	1	1	.../ 60 mV (*)	V, A, kW, kWh	LED

LM Impulse centralisers, see section Measurement/Control devices
RS/TCP/CMBUS, Communication converters

Type	Code	Description
RS2RS	[*] M62141.	RS-232/485 Intelligent converter and amplifier (RTS control) for PC
USB-RS 485	[*] M54040.	USB to RS-485 Converter
USB-RS 232	[*] M54050.	USB to RS-232 Converter
TCP1RS+	[*] M62121.	RS-485 / Ethernet modbus/TCP Converter
TCP2RS+	[*] M54033.	RS-232/485 Converter / Ethernet Modbus/TCP. Built-in web server and web set-up
CMBUS-8	[*] M540A0.	M-Bus to Modbus Converter, up to 8 Mbus slaves
CMBUS-24	[*] M540B0.	M-Bus to Modbus Converter, up to 24 Mbus slaves

AIR, Wireless converters and probes

Wi-fi converters and sensors



Type	Code	Description
air GATEWAY	[*] M62001.	Router RS485 Modbus/RTU to Radio
air BRIDGE	[*] M62002.	Radio Router to RS485 Modbus/RTU
air REPEATER	[*] M62003.	Signal repeater
air THL	[*] M62004.	Wireless temperature, relative humidity and brightness analyzer
air HANDZER	[*] M62005.	Portable wireless signal coverage analyzer
air TIDCI	[1] M62006.	2 NTC sensor + 2 S0 impulse counter

Modems, Communication accessories

Type	Code	Description
M-GSM 10 BITS	[*] Q30213IB00000	GSM RS-232/485 Modem (includes antenna + cable). Parameterisation with even parity (10 bits)
M-GSM 11 BITS	[*] Q30213EN00000	GSM RS-232/485 Modem (includes antenna + cable). Parameterisation with even parity (11 bits)
SGE-3G/GPRS	[*] Q30230.	GPRS-3G Modem with Ethernet communications (includes PS + antenna + cable)
ANTENA GSM UT-35 9db	[1] Q4994E.	Antenna 9 db (for GSM modem)



PowerStudio, Energy management software

Type	Code	Description
Software SCADA		
PowerStudio	[*] M90211.	Software with USB HASP licence. Configuration, monitoring in real time, display of graphs and tables
PowerStudio-Scada	[*] M90231.	Software with USB HASP licence. Configuration, monitoring in real time, display of graphs and tables, generation of reports, creation of SCADA screens and alarms
PowerStudio-Deluxe	[C] M90241.	Software with USB HASP licence. Software PowerStudio-Scada with Generic Modbus driver used to connect to other devices available in the market
OPC Server PS/PSS	[1] M91111.	Software with USB HASP licence. OPC Sever for PowerStudio is an integration platform that can easily integrate the parameters received from PowerStudio (or any of its versions) in any SCADA platform available in the market with a simple approach.
SQL DATA EXPORT	[1] M91301.	Software with USB HASP licence. SQL Data Export for PS/PSS is a software tool for the integration of data from PS/PSS to a new or existing SQL database.

License 4.0 version 4.0

Dimensions

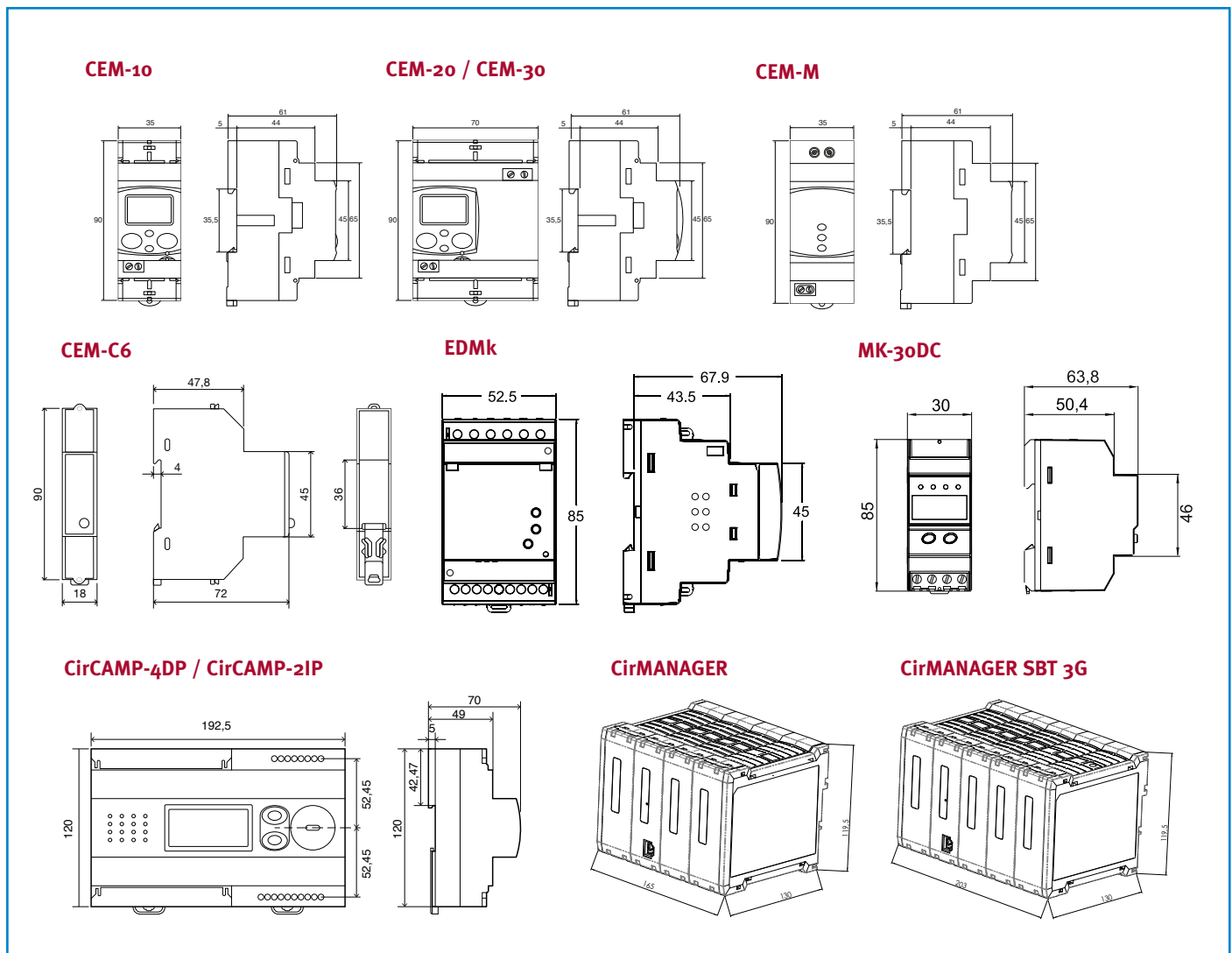





PROTECTION AND CONTROL

Industrial earth leakage protection

WGC, Earth leakage transformer	96
TP-WG, Split-core earth leakage transformers/core balanced	97
RGU-10, Earth leakage relay for Type A ultra-immunised WGC Transformer, 3 modules with display and programmable pre-alarm output	97
RGU-2, Programmable earth leakage relay, 2 modules with display and static prealarm output	97
RG1M, Earth leakage relays 1 module	97
RGE, Earth leakage relay for WGC transformer, type A, 2 modules with visual prealarm	97
CBS-4, Station with 4 programmable earth leakage relays, 4 modules with display and a configurable prealarm output	98
WRU, Type A ultra-immunised earth leakage relay with built-in transformer	98
WRN, Earth leakage relay with built-in transformer, Type A	98
WGBU, Transformer with built-in earth leakage relay, Type A	98
RGMD, Earth leakage protection assembly with miniature circuit breaker, ultra-immunised	99
WGC-TB, Earth leakage transformers for type-B earth leakage relays	99
RGU-10B, Earth leakage current monitoring relay, type-B	99
IDB-4, RCCB Type B	99
WGB-35-TB, Relay Type B built-in earth leakage current transformer	99

Self-reclosing overcurrent and Earth leakage protection

WGC, Earth leakage transformer	102
TP-WG, Split-core earth leakage transformers/core balanced	102
REC3, RCCB with self-reclosing system, type A	103
RGU-10 RAL, Reclosing protection relays and earth leakage reclosing with WGC external transformer	103
CBS4-RA, Central protection and earth leakage reclosing with WGC external transformer	103
WRU-10RAL, Protection relays and earth leakage reclosing, Type A ultra-immunised with built-in transformer	103
WRU-10k, Earth leakage relay with built-in transformer	104
MCB, Motorized circuit breakers for overcurrent and earth leakage protection with reclosing by differential relay	104
RECmax-CVM, Self-reclosing earth leakage really with power analyzer functions, transformers included	104
RECmaxLPD, Self-reclosing earth leakage relay with circuit breaker, used with an external earth leakage transformer	105
RGU-10 MT, Reclosing earth leakage relay for motorized circuit breakers	105
WRU-10MT, Earth leakage relay with built-in transformer	106
RECmaxMP, Motorized circuit breakers (up to 63 A)	106
MT-FDE, Motorized circuit breaker for currents exceeding than 63 A	106
WRGU-10-MTT, Full earth leakage and circuit breaker reclosing and protection unit, panel	107
RECmaxP, Motorized circuit breakers, up to 63 A	107
RRM, Overcurrent tripping relay with self-reclosing system	107

Relays and control elements

IMD-2R, Monitoring relay for offline insulation	109
TB, Bacon control equipment	109
RV, Voltage detector relays (AC), DIN rail	109
WI, Current detector relay (AC), DIN rail	109
CDR, Station with 8 current relays, display and RS-485 communications	109







Protection current transformer

TRP, Protection transformers encapsulated in resin	111
--	-----

Measuring and testing equipments for substations

GETEST, Indirect earth contact simulator	113
CR, Relay tester	113
OT2, Dielectric strenght tester	113
MH, Microohmmeter	113
MD, Megaohmmeters	113
TL, Earth resistance meter	113
PI-23, High voltage clamps	114

OUTSTANDING PRODUCTS

	RG1M	RGU-2	RGU-10B	RGMD	REC3/REC3C	RECmax CVM
						
	Earth leakage relays 1 module	Earth leakage relays 2 modules	Type-B earth leakage current monitoring relay	Earth leakage protection assembly with built-in circuit breaker protection	RCCB with self-reclosing system and output contact	Self-reclosing earth leakage really with power analyzer functions
Page	97	97	99	99	103	104

Industrial earth leakage protection

Table: Selection of earth leakage relays

	RG1M	WRN-22	RGE-R	WGBU	RGU-2	RGU-10	CBS-4	WRU-10	RGU-10B	IDB4	WGB-35-TB
Client requirements											
Continuity of service Prevents unwanted tripping	•	•	•	•	•	•	•	•	•	•	•
Control, telemanagement	-	-	-	-	•	•	•	•	•	-	-
Monitoring (display/PC)	-	-	-	-	•	•	•	•	•	-	-
Preventive maintenance, prealarm	-	-	•	•	•	•	•	•	•	-	-
Installation											
Use in single-phase installations	•	•	•	•	•	•	•	•	•	•	•
Three-phase, with & without neutral	•	•	•	•	•	•	•	•	•	•	•
WGC External earth leakage transformers	•	-	•	-	•	•	•	-	WGC-TB	-	-
Useful section diameter ø (mm)	DET	22	DET	35...210	DET	DET	DET	28	DET	-	35
Size in modules	1	3	2	-	2	3	3	3	3	4	-
Model features											
Earth leakage protection type (IEC 60755)	A	A	A	A	A	A	A	A	B	B	B
Use as instantaneous protection	•	•	•	•	•	•	•	•	-	•	•
Use as selective protection / monitoring	-	-	•	•	•	•	•	•	•	-	•
Fixed sensitivity and trip delay	•	•	-	-	-	-	-	-	-	•	•
Adjustable sensitivity and trip delay	-	-	•	•	•	•	•	•	•	-	-
RS-485/Modbus communications protocol	-	-	-	-	•	•	•	-	-	-	-
External input, remote control	-	-	-	-	•	•	•	•	•	-	-
Page	97	98	97	98	97	97	98	98	99	99	99

DET - Depending on the external transformer

WGC, Earth leakage transformer

Type	Code	Usefull diam.(mm)	IΔn	weight (kg)
WGC-20-SC	[*] P10181.	20	acc. relay	0,08
WGC-30-SC	[*] P10182.	30	acc. relay	0,10
WGS-20	[*] P10131.	20	acc. relay	0,08
WGS-30	[*] P10132.	30	acc. relay	0,10
WGC-25	[*] P10151.	25	acc. relay	0,08
WGC-35	[*] P10152.	35	acc. relay	0,12
WGC-55	[*] P10153.	55	acc. relay	0,16
WGC-80	[*] P10154.	80	acc. relay	0,30
WGC-110	[*] P10155.	115	acc. relay	0,42
WGC-140	[*] P10156.	140	acc. relay	0,76
WGC-180	[*] P10157.	180	acc. relay	1,48
WGC-220x105	[*] P10158.	220 x 105	acc. relay	3,74
WGC-350x150	[*] P10159.	350 x 150	acc. relay	7,80
WGC-500x200	[*] P10160.	500 x 200	acc. relay	11,30

UL certification for all WGC and WGS models, on demand

Type	Code	Description
PA-TC/WG (kit 2 uds)	[*] P19921.	DIN rail mounting accessory for WGC-25, WGC-35 and WGC-55

**TP-WG, Split-core earth leakage transformers/core balanced**

Type	Code	Usefull diam.(mm)	I Δ n	I Δ n min.(A)	weight (kg)
TP58 WGC	[C] P11121.	80 x 50	acc. relay > 0,3A	0.3	1
TP88 WGC	[C] P11131.	80 x 80	acc. relay > 0,3A	0.3	1.3
TP812 WGC	[C] P11141.	120 x 80	acc. relay > 0,3A	0.3	1.6
TP816 WGC	[C] P11151.	160 x 80	acc. relay > 0,3A	0.3	4.1

Only for RGU-2, RGU-10/10C, CBS-4/4C

**RGU-10, Earth leakage relay for Type A ultra-immunised WGC Transformer, 3 modules with display and programmable pre-alarm output.**

Type	Code	I Δ n	Módulos	Delay	Communications	Power supply
Possibility UL on demand						
RGU-10	[*] P11941.	0,03 ... 3 A	0,03 ... 30 A 3	0,02 ... 10 s, INS, SEL (*1)(*2)	-	230 Vac
RGU-10C	[*] P11944.	0,03 ... 3 A	0,03 ... 30 A 3	0,02 ... 10 s, INS, SEL (*1)(*2)	RS-485	230 Vac

(*1) The delay is cancelled in all relays with a 0.03 A sensitivity adjustment, according to IEC 60947-2, annex M (*2) INS, SEL trip curves, according to IEC 61008-1, for trigger coils with a tripping time < 0.02 s Requires a WGC earth leakage transformer To encode other parameters, such as the auxiliary power supply voltage, see the table at the end of the section

Type	Code	Description
ADP CVM-MINI/ RGU10/CBS4	[*] M5ZZF1.	Panel adapter CVM MINI / RGU-10 / CBS-4 (72 x 72)

**RGU-2, Programmable earth leakage relay, 2 modules with display and static prealarm output**

Type	Code	I Δ n	Módulos	Mounting	Delay	Power supply
RGU2	[*] P11A61.	0,03 ... 5A	2	DIN rail	0,1 ... 5 s, INS, SEL (*1)(*2)	120...230 Vac

(*1) The delay is cancelled in all relays with a 0.03 A sensitivity adjustment, according to IEC 60947-2, annex M (*2) INS, SEL trip curves, according to IEC 61008-1, for trigger coils with a tripping time < 0.02 s Requires a WGC earth leakage transformer To encode other parameters, such as the auxiliary power supply voltage, see the table at the end of the section

RG1M, Earth leakage relays 1 module

Type	Code	I Δ n	Módulos	Mounting	Delay	Power supply
RG1M - 0,03	[*] P12204.	0,03 A	1	DIN rail	0,02 S	230 Vac
RG1M - 0,3	[*] P12214.	0,3 A	1	DIN rail	0,02 S	230 Vac

(*1) The delay is cancelled in all relays with a 0.03 A sensitivity adjustment, according to IEC 60947-2, annex M (*2) INS, SEL trip curves, according to IEC 61008-1, for trigger coils with a tripping time < 0.02 s Requires a WGC earth leakage transformer To encode other parameters, such as the auxiliary power supply voltage, see the table at the end of the section

**RGE, Earth leakage relay for WGC transformer, type A, 2 modules with visual prealarm.**

Type	Code	I Δ n	Módulos	Mounting	Delay	Power supply
RGE-R1	[*] P12231.	0,03 ... 3 A	2	DIN rail	0,02 ... 1 s (*1)	230 Vac
RGE-RL	[*] P12A32.	0,03 ... 5 A	2	DIN rail	0,02 ... 5 s (*1)	230 Vac
RGE-R	[*] P122320040000	0,03 ... 5 A	2	DIN rail	0,02 ... 5 s (*1)	24...48 Vac / 24...125 Vdc

Requires a WGC earth leakage transformer To encode other parameters, such as the auxiliary power supply voltage, see the table at the end of the section



CBS-4, Station with 4 programmable earth leakage relays, 4 modules with display and a configurable prealarm output.

Type	Code	I Δ n	N° relays	Módulos	Delay	Communications	Power supply
CBS-4	[*] P12711.	0,03 ... 30 A	4	3	0,02 ... 10 s, INS, SEL	-	230 Vac
CBS-4C	[*] P12712.	0,03 ... 30 A	4	3	0,02 ... 10 s, INS, SEL	RS-485	230 Vac

The delay is cancelled in all relays with a sensitivity adjustment of 0.03 A, IEC 60947-2, annex M
 Delay: INS, SEL trip curves, according to IEC 61008-1, for trigger coils with a trip time <0.02 s
 Optional UL certification in CBS-4 at 230 Vac (not available for other power supply values).
 To encode other parameters, such as the auxiliary power supply voltage, see the table at the end of the section

Type	Code	Description
ADP CVM-MINI/ RGU10/CBS4	[*] M5ZZF1.	Panel adapter CVM MINI / RGU-10 / CBS-4 (72 x 72)

WRU, Type A ultra-immunised earth leakage relay with built-in transformer

Programmable earth leakage relay, 3 modules with display and two configurable pre-alarm outputs. 230 Vac Auxiliary power supply

Type	Code	Usefull diam.(mm)	I Δ n	Módulos	Delay	Power supply
WRU-10	[*] P14035.	28	0,03 ... 3 A / 0,03 ... 30 A	3	0,02 ... 10s, INS, SEL	230 Vac

The delay is cancelled in all relays with a 0.03 A sensitivity adjustment, according to IEC 60947-2, annex M
 INS, SEL trip curves, according to IEC 61008-10, for trigger coils with a tripping time <0.02 s
 To encode other parameters, such as the auxiliary power supply voltage, see the table at the end of the section

WRN, Earth leakage relay with built-in transformer, Type A

Type	Code	Usefull diam.(mm)	I Δ n	Delay
WRN-22-0,03	[*] P14211.	22	0,03 A	0,02 s
WRN-22-0,3	[*] P14212.	22	0,3 A	0,02 s
WRN-22-0,01	[*] P14214.	22	0,01 A	0,02 s

WGBU, Transformer with built-in earth leakage relay, Type A.

Configurable earth leakage relay with visual pre-alarm. 230 Vac Auxiliary power supply

Type	Code	Usefull diam.(mm)	I Δ n	Delay
WGBU-35	[*] P16011.	35	0,03 ... 3 A	0,02...1 s
WGBU-70	[*] P16012.	70	0,03 ... 3 A	0,02...1 s
WGBU-105	[*] P16013.	105	0,03 ... 3 A	0,02...1 s
WGBU-140	[*] P16014.	140	0,03 ... 3 A	0,02...1 s
WGBU-210	[*] P16015.	210	0,03 ... 3 A	0,02...1 s
WGBU-90-35	[*] P16021.	35	0,03 ... 3 A	0,02...1 s
WGBU-90-70	[*] P16022.	70	0,03 ... 3 A	0,02...1 s
WGBU-90-105	[*] P16023.	105	0,03 ... 3 A	0,02...1 s
WGBU-90-140	[*] P16024.	140	0,03 ... 3 A	0,02...1 s
WGBU-90-210	[*] P16025.	210	0,03 ... 3 A	0,02...1 s

The delay is cancelled in all relays with a sensitivity adjustment of 0.03 A, IEC 60947-2, annex M

CODIFICATION TABLE

RGU-10, RGE, CBS-4, WRU-10		
Code	Internal code	
P 1 X X X X 0 0 X	X X	
	↑ ↑ ↑ Delivery time	
Standard (230 V _{ac})	0	--
Power supply voltage	1	1
110 V _{ac}	1	
400 V _{ac} (Only RGE, RGU-10)	3	1
24..48 V _{dc} , 24...125 V _{dc} (Only RGE, RGU-10)	4	1
Certificate UL (Only RGU10/10C - 230 V _{ac})	0 7	2
Certificate CCC (Only RGU10 - 230 V _{ac})	0 8	2

Delivery time: [*] immediate
 [x] working weeks
 [c] consult

**RGMD, Earth leakage protection assembly with miniature circuit breaker, ultra-immunised**

Type	Code	In (A)	Poles	Sensitivity
RGMD Series, type A - 2 poles				
RGMD-2-16-30	[1] P13231.	16 A	2	30 mA
RGMD-2-25-30	[1] P13251.	25 A	2	30 mA
RGMD-2-32-30	[1] P13261.	32 A	2	30 mA
RGMD-2-40-30	[1] P13271.	40 A	2	30 mA
RGMD-2-63-30	[1] P13291.	63 A	2	30 mA
RGMD-2-16-300	[1] P13233.	16 A	2	300 mA
RGMD-2-25-300	[1] P13253.	25 A	2	300 mA
RGMD-2-32-300	[1] P13263.	32 A	2	300 mA
RGMD-2-40-300	[1] P13273.	40 A	2	300 mA
RGMD-2-63-300	[1] P13293.	63 A	2	300 mA
RGMD Series, type A - 4 poles				
RGMD-4-16-30	[1] P13431.	16 A	4	30 mA
RGMD-4-25-30	[1] P13451.	25 A	4	30 mA
RGMD-4-32-30	[1] P13461.	32 A	4	30 mA
RGMD-4-40-30	[1] P13471.	40 A	4	30 mA
RGMD-4-63-30	[1] P13491.	63 A	4	30 mA
RGMD-4-16-300	[1] P13433.	16 A	4	300 mA
RGMD-4-25-300	[1] P13453.	25 A	4	300 mA
RGMD-4-32-300	[1] P13463.	32 A	4	300 mA
RGMD-4-40-300	[1] P13473.	40 A	4	300 mA
RGMD-4-63-300	[1] P13493.	63 A	4	300 mA

It features an RG1M earth leakage relay, WGS/WGC earth leakage transformer and C curve circuit breaker, 6 kA (EN 60898) with 230 Vac trigger coil

Earth leakage relay for Type B**WGC-TB, Earth leakage transformers for type-B earth leakage relays**

Type	Code	Usefull diam.(mm)	I Δ n min.(A)	weight (kg)
WGS-20-TB	[*] P11731.	20	0.1	0,08
WGC-25-TB	[*] P11751.	25	0.1	0,09
WGC-35-TB	[*] P11752.	35	0.1	0,13
WGC-55-TB	[*] P11753.	55	0.3	0,18
WGC-80-TB	[*] P11755.	80	0.5	0,32
WGC-110 TB	[*] P11756.	110	0.5	0,44
WGC-140TB	[*] P11757.	140	0.5	0,79
WGC-180 TB	[*] P11758.	180	0.5	1,53

RGU-10B, Earth leakage current monitoring relay, type-B

Programmable earth leakage relay, 3 modules with display and configurable pre-alarm output.



Type	Code	I Δ n	Módulos	Mounting	Delay	Power supply
RGU10B	[*] P11951.	0,1 ... 3 A	3	DIN rail	0,1 ... 10 s	230 Vac

Requires an earth leakage transformer, WGC-TB type

IDB-4, RCCB Type B

Type	Code	In (A)	Poles	Sensitivity
IDB-4 4P-40A-30 mA	[*] P17221.	40 A	4	30 mA
IDB-4 4P-40A-300 mA	[*] P17222.	40 A	4	300 mA
IDB-4 4P-63A -30 mA	[*] P17231.	63 A	4	30 mA
IDB-4 4P-63A -300mA	[*] P17232.	63 A	4	300 mA

WGB-35-TB, Relay Type B built-in earth leakage current transformer

Type	Code	Delay	Sensitivity
WGB-35-TB30	[*] P16111.	INS	30 mA
WGB-35-TB300	[*] P16121.	INS	300 mA
WGB-35-TB300S	[*] P16131.	SEL	300 mA

Dimensions

RG1M

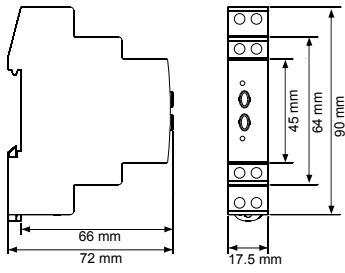

RGE

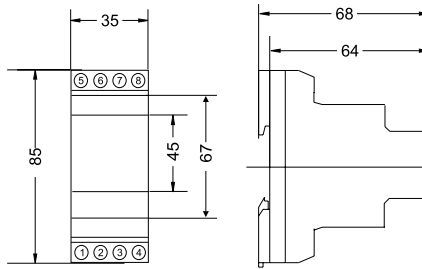

RGU-10 / CBS-4

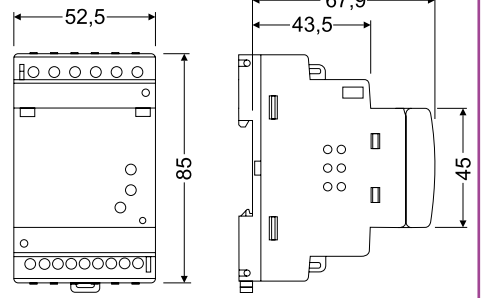

RGU2

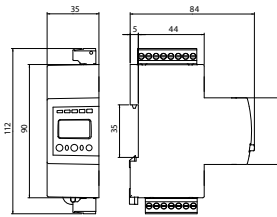

WRN-22

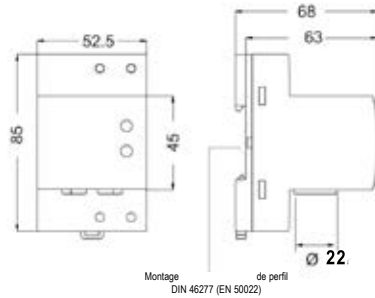

WRU-10

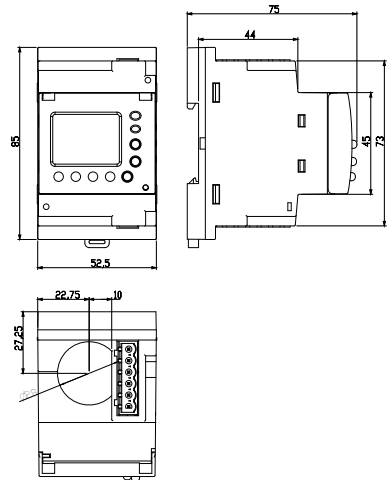

RGMD 2P / RGMD 4P

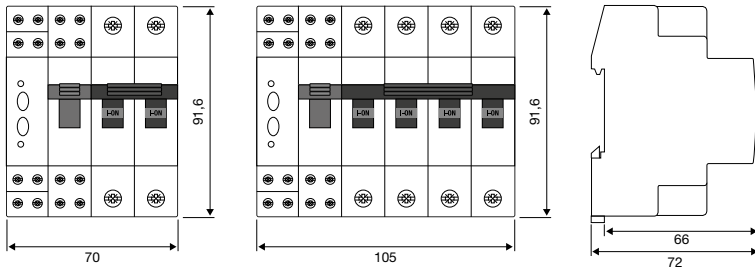

WGB-35-TB

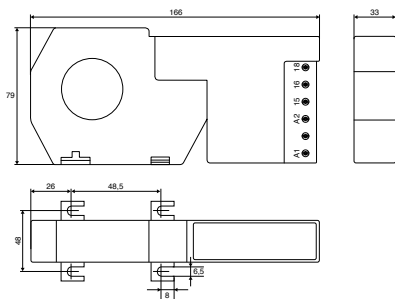

IDB-4

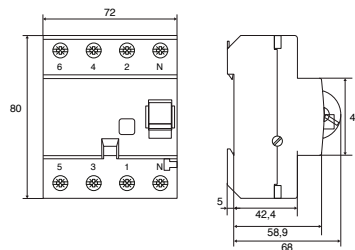

Dimensions

WGC / WGC-TB

WGC 25 / WGC 35

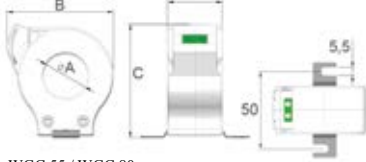

WGC 55 / WGC 80

WGC 110 / WGC 140

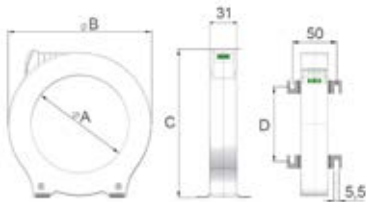

Modelo	A	B	C	D
WGC 25	25	60,5	64	
WGC 35	35	70,5	75,5	
WGC 55	55	92	98	38
WGC 80	80	124,5	130	60
WGC 110	110	163	168	84,5
WGC 140	140	201	206	110
WGC 180	180	252	256	144

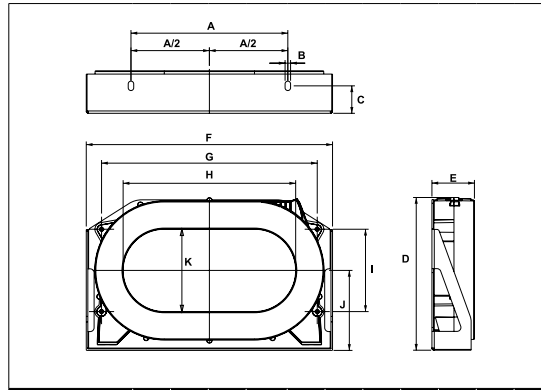

	A	B	C	D	E	F	G	H	I	J	K
WGC 220x105	200	7	35	195	54,2	314	275	220	105	102	105
WGC 350x150	340	7	30	279	50,2	479	430	350	165	143	150
WGC 500x200	460	7	40	306	64	614	550	500	180	155	200

WGS

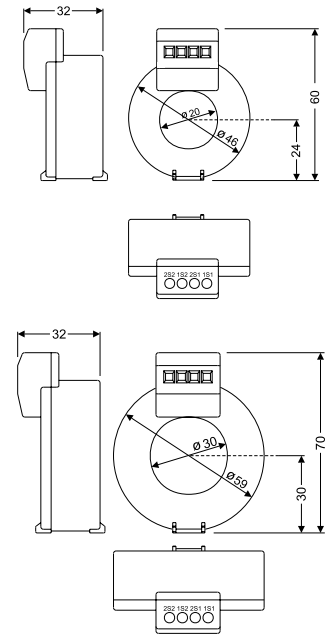

WGBU

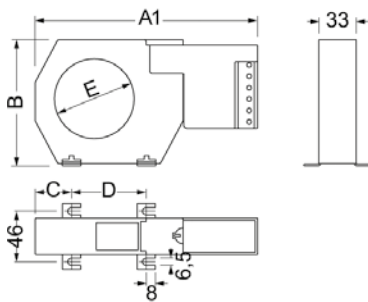

WGBU-90

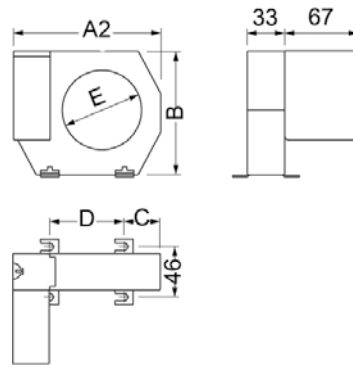

Type	A1	A2	B	C	D	E
WGBU-35 (A1) / WGBU-90-35 (A2)	166	100	79	26	48,5	35
WGBU-70 (A1) / WGBU-90-70 (A2)	196	130	110	332	66	70
WGBU-105 (A1) / WGBU-90-105 (A2)	236	170	146	38	94	105
WGBU-140 (A1) / WGBU-90-140 (A2)	286	220	196	48,5	123	140
WGBU-210 (A1) / WGBU-90-210 (A2)	365	299	284	69	161	210

TP-WGC

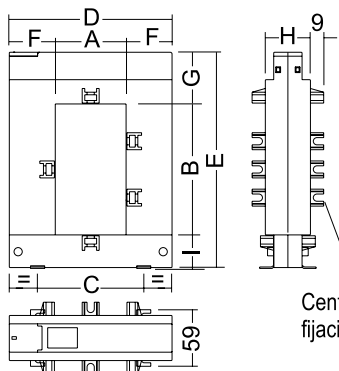

Centradores de fijación pletina

dimensiones (mm)	TP-23	TP-58	TP-88	TP-812	TP-816
a	20	50	80	80	80
b	30	80	80	120	160
c	51	78	108	108	120
d	89	114	144	144	184
e	110	145	145	185	245
f	34	32	32	32	52
g	47	32	32	32	47
h	40	32	32	32	52
i	32	32	32	32	38

Nota: Todos los tipos llevan centradores de fijación, excepto el TP-23

Self-reclosing overcurrent and Earth leakage protection

Table: Selection of self-reclosing earth leakage and circuit breaker protection units

Protection	Reclosing	Solutions	Units	Page
Earth leakage	Earth leakage	Self-reclosing RCCB	REC2 / REC3C	103
		Programmable earth leakage relay + external transformer + contactor	RGU-10 RAL + WGC	105
			CBS-4 RA + WGC	103
		Programmable earth leakage relay with built-in transformer + contactor	WRU RAL	104
Earth leakage and circuit breaker	Earth leakage	Earth leakage relay with built-in transformer + Motorized circuit breaker	WRU-10k + MCB.P	105
		Programmable earth leakage relay with circuit breaker + external transformer	RECmax-LDP + WGC 25/30/35	104
	Earth leakage and circuit breaker	Programmable earth leakage relay with circuit breaker +MEASURE + external transformer	RECmax-CVM + WGC 20/30-SC + MC1	104
		Programmable earth leakage relay + external transformer + motorized circuit breaker	RGU-10 MT + WGC + RECmax MP + MT-FDE ($I_n > 63$ A)	105
		Earth leakage relay with built-in transformer + motorized circuit breaker	WRU-10 MT + RECmax MP	106
	Compact unit, ready to be installed	WRGU-10 MTT	107	
	Circuit breaker	Circuit breaker	Self-reclosing circuit breaker	RECmax P
Programmable reclosing relay + motorized switch			RRM + MT/RECmax MP (consult)	107

WGC, Earth leakage transformer

Type	Code	Usefull diam.(mm)	IΔn	weight (kg)
WGC-20-SC	[*] P10181.	20	acc. relay	0,08
WGC-30-SC	[*] P10182.	30	acc. relay	0,10
WGS-20	[*] P10131.	20	acc. relay	0,08
WGS-30	[*] P10132.	30	acc. relay	0,10
WGC-25	[*] P10151.	25	acc. relay	0,08
WGC-35	[*] P10152.	35	acc. relay	0,12
WGC-55	[*] P10153.	55	acc. relay	0,16
WGC-80	[*] P10154.	80	acc. relay	0,30
WGC-110	[*] P10155.	115	acc. relay	0,42
WGC-140	[*] P10156.	140	acc. relay	0,76
WGC-180	[*] P10157.	180	acc. relay	1,48
WGC-220x105	[*] P10158.	220 x 105	acc. relay	3,74
WGC-350x150	[*] P10159.	350 x 150	acc. relay	7,80
WGC-500x200	[*] P10160.	500 x 200	acc. relay	11,30

UL certification for all WGC and WGS models, on demand

Type	Code	Description
PA-TC/WG	[*] P19921.	DIN rail mounting accessory for WGC-25, WGC-35 and WGC-55

TP-WG, Split-core earth leakage transformers/core balanced

Type	Code	Usefull diam.(mm)	IΔn	IΔn min.(A)	weight (kg)
TP58 WGC	[C] P11121.	80 x 50	acc. relay > 0,3A	0.3	1
TP88 WGC	[C] P11131.	80 x 80	acc. relay > 0,3A	0.3	1.3
TP812 WGC	[C] P11141.	120 x 80	acc. relay > 0,3A	0.3	1.6
TP816 WGC	[C] P11151.	160 x 80	acc. relay > 0,3A	0.3	4.1

Only for RGU-2, RGU-10/10C, CBS-4/4C

 Delivery time: [*] immediate
 [x] working weeks
 [c] consult

EARTH LEAKAGE PROTECTION AND SELF-RECLOSING

**REC3, RCCB with self-reclosing system, type A**

Type	Code	In (A)	Poles	Sensitivity	Reclosing mode
REC3-2P-40-30M	[*] P26121.	40 A	2	30 mA	Isulation
REC3-2P-63-30M	[*] P26131.	63 A	2	30 mA	Isulation
REC3-2P-40-300T	[*] P26123.	40 A	2	300 mA	Time
REC3-2P-63-300T	[*] P26133.	63 A	2	300 mA	Time
REC3-4P-40-30M	[*] P26221.	40 A	4	30 mA	Isulation
REC3-4P-63-30M	[*] P26231.	63 A	4	30 mA	Isulation
REC3-4P-40-300T	[*] P26223.	40 A	4	300 mA	Time
REC3-4P-63-300T	[*] P26233.	63 A	4	300 mA	Time

RCCB with self-reclosing system and output contact

REC3C 2P-40-30M	[*] P26811.	40 A	2	30 mA	Isulation
REC3C 2P-63-30M	[*] P26814.	63 A	2	30 mA	Isulation
REC3C 2P-40-300T	[*] P26721.	40 A	2	300 mA	Time
REC3C 2P-63-300T	[*] P26724.	63 A	2	300 mA	Time
REC3C 4P-40-30M	[*] P26812.	40 A	4	30 mA	Isulation
REC3C 4P-63-30M	[*] P26815.	63 A	4	30 mA	Isulation
REC3C 4P-40-300T	[*] P26722.	40 A	4	300 mA	Time
REC3C 4P-63-300T	[*] P26725.	63 A	4	300 mA	Time

3 reconections: 3, 20, 180 s. Complies with the EN 50557 Standard

Programmable earth leakage relays, used with an external earth leakage transformer and contactor

Complete set formed by: Earth leakage relay + Contactor + WGC transformer

RGU-10 RAL, Reclosing protection relays and earth leakage reclosing with WGC external transformer

Type A ultra-immunised earth leakage relay, programmable, 3 modules with display and locking status release by reclosing. 230 Vac auxiliary power supply.



Type	Code	IΔn	Breaking element	Delay	Communications	Nr. reclosures
RGU-10 RAL	[*] P24622.	0,03 ... 30 A	Contactor	0,02...10 s, INS, SEL	-	Programmable
RGU-10C RAL	[*] P24662.	0,03 ... 30 A	Contactor	0,02...10 s, INS, SEL	RS-485	Programmable

The delay is cancelled in all relays with a sensitivity adjustment of 0.03 A, IEC 60947-2, annex M.

(*1) INS, SEL trip curves, according to IEC 61008-1, for trigger coils with a trip time <0.02 s

Requires an earth leakage transformer, WGC type and contactor (not included)

To encode other parameters, see the table at the end of the section

CBS4-RA, Central protection and earth leakage reclosing with WGC external transformer

Station with 4 Type A ultra-immunised earth leakage relays, programmable, 4 modules with display and locking status release by reclosing. 230 Vac Auxiliary power supply



Type	Code	IΔn	Nº relays	Delay	Communications	Nr. reclosures
CBS-4 RA	[*] P24911.	0,03 ... 30 A	4	0,02 ... 10 INS, SEL	-	Programmable
CBS-4C-RA	[*] P24912.	0,03 ... 30 A	4	0,02 ... 10 INS, SEL	RS-485	Programmable

The delay is cancelled in all relays with a sensitivity adjustment of 0.03 A, IEC 60947-2, annex M

(*1) INS, SEL trip curves, according to IEC 61008-1, for trigger coils with a trip time <0.02 s

Requires an earth leakage transformer, WGC type and contactor (not included)

To encode other parameters, see the table at the end of the section

Programmable earth leakage relays with built-in transformer, used with a contactor

Complete set formed by: Earth leakage relay + Contactor

WRU-10RAL, Protection relays and earth leakage reclosing, Type A ultra-immunised with built-in transformer

Relé diferencial programable, 3 módulos, display con salida de prealarma y bloqueo por reconexiones. Alimentación auxiliar 230 Vca



Type	Code	Usefull diam.(mm)	IΔn	Delay	Nr reclosures	Time between reclosures
WRU-10-RAL	[*] P24453.	28	0,03 ... 3 A 0,03 ... 30 A	0,02...10 s, INS, SEL (*1)	Programmable	Programmable

STREET LIGHTING WITH SIGN POSTING, contactor circuit breaker

WRU-10-RAL0,3-1	[*] P24457.	28	0,3 ... 1 A	0,02 INS	Programmable	Programmable
-----------------	-------------	----	-------------	----------	--------------	--------------

The delay is cancelled in all relays with a 0.03 A sensitivity adjustment, according to IEC 60947-2, annex M (*2) INS, SEL trip curves, according to IEC 61008-1, for trigger coils with a tripping time < 0.02 s The contactor is not supplied. To encode other parameters, see the table at the end of the section

OVERCURRENT AND EARTH LEAKAGE PROTECTION, EARTH LEAKAGE SELF-RECLOSING
Programmable earth leakage relays with built-in transformer and motorized circuit breaker

Complete set formed by: Earth leakage relay K Series + MCB circuit breaker

WRU-10k, Earth leakage relay with built-in transformer

Relé diferencial tipo A ultraimmunizado, programable en 3 módulos, display para funcionar con disyuntor MCB.P. Alimentación auxiliar 230 Vca

Type	Code	Usefull diam.(mm)	IΔn	Delay	Nr reclosures	Time between reclosures
WRU-10K	[C] P23261.	28	0,03 ... 3 A	0,02 ... 1 s	30	20 s, 40 s and all others every 5 min
WRU-10K	[C] P23262.	28	0,03 A	INS	15	20 s, 40 s then every 5 min

Certified and Approved by Telefónica The delay is cancelled in all relays with a sensitivity adjustment of 0.03 A, IEC 60947-2 annex M. Requires a motorised circuit breaker, MCB.P type (not included)

MCB, Motorized circuit breakers for overcurrent and earth leakage protection with reclosing by differential relay

Type	Code	In (A)	Poles	Type	Code	In (A)	Poles
2 Poles, C Curve				4 Poles, C Curve			
MCB.P C-2p-6A	[*] P20210.	6 A	2	MCB.P C-3p+N-10A	[*] P20221.	10 A	4
MCB.P C-2p-10A	[*] P20211.	10 A	2	MCB.P C-3p+N-16A	[*] P20223.	16 A	4
MCB.P C-2p-16A	[*] P20213.	16 A	2	MCB.P C-3p+N-20A	[*] P20224.	20 A	4
MCB.P C-2p-20A	[*] P20214.	20 A	2	MCB.P C-3p+N-25A	[*] P20225.	25 A	4
MCB.P C-2p-25A	[*] P20215.	25 A	2	MCB.P C-3p+N-32A	[*] P20226.	32 A	4
MCB.P C-2p-32A	[*] P20216.	32 A	2	MCB.P C-3p+N-40A	[*] P20227.	40 A	4
MCB.P C-2p-40A	[*] P20217.	40 A	2	MCB.P C-3p+N-50A	[*] P20228.	50 A	4
MCB.P C-2p-50A	[*] P20218.	50 A	2	MCB.P C-3p+N-63A	[*] P20229.	63 A	4
MCB.P C-2p-63A	[*] P20219.	63 A	2	Contacto aux.MCB/P/T	[*] P29001.	-	-

Only for operation with WRU-10K

C curve circuit breaker with a 6 kA cut off power (EN 60898); optional D curve (up to 32 A), for an additional charge of 10%

OVERCURRENT AND EARTH LEAKAGE PROTECTION AND RECLOSING
Programmable earth leakage relays with circuit breaker and external transformer

Set composed of: Earth leakage relay with built-in circuit breaker + WGC-SC Transformer + MC Measurement transformer

RECmax-CVM, Self-reclosing earth leakage really with power analyzer functions, transformers included

Type	Code	In (A)	Poles	Type	Code	In (A)	Poles
RECmax-CVM 2P C2-10	[2] P2B111.	10	2	RECmax-CVM 2P D2-10	[2] P2B131.	10	2
RECmax-CVM 2P C2-16	[2] P2B112.	16	2	RECmax-CVM 2P D2-16	[2] P2B132.	16	2
RECmax-CVM 2P C2-20	[2] P2B113.	20	2	RECmax-CVM 2P D2-20	[2] P2B133.	20	2
RECmax-CVM 2P C2-25	[2] P2B114.	25	2	RECmax-CVM 2P D2-25	[2] P2B134.	25	2
RECmax-CVM 2P C2-32	[2] P2B115.	32	2	RECmax-CVM 2P D2-32	[2] P2B135.	32	2
RECmax-CVM 2P C2-40	[2] P2B116.	40	2	RECmax-CVM 2P D2-40	[2] P2B136.	40	2
RECmax-CVM 2P C2-50	[2] P2B117.	50	2	RECmax-CVM 2P D2-50	[2] P2B137.	50	2
RECmax-CVM 2P C2-63	[2] P2B118.	63	2	RECmax-CVM 2P D2-63	[2] P2B138.	63	2
RECmax-CVM 4P C4-10	[2] P2B121.	10	4	RECmax-CVM 4P D4-10	[2] P2B141.	10	4
RECmax-CVM 4P C4-16	[2] P2B122.	16	4	RECmax-CVM 4P D4-16	[2] P2B142.	16	4
RECmax-CVM 4P C4-20	[2] P2B123.	20	4	RECmax-CVM 4P D4-20	[2] P2B143.	20	4
RECmax-CVM 4P C4-25	[2] P2B124.	25	4	RECmax-CVM 4P D4-25	[2] P2B144.	25	4
RECmax-CVM 4P C4-32	[2] P2B125.	32	4	RECmax-CVM 4P D4-32	[2] P2B145.	32	4
RECmax-CVM 4P C4-40	[2] P2B126.	40	4	RECmax-CVM 4P D4-40	[2] P2B146.	40	4
RECmax-CVM 4P C4-50	[2] P2B127.	50	4	RECmax-CVM 4P D4-50	[2] P2B147.	50	4
RECmax-CVM 4P C4-63	[2] P2B128.	63	4	RECmax-CVM 4P D4-63	[2] P2B148.	63	4

All models feature the WGC20/30-SC earth leakage transformer and MC-3 or MC-1 measuring transformer with connected terminal

Earth leakage relay with adjustable sensitivity (0.03 A, up to 1 A), adjustable delay (with curve, INS/SEL, or by time, from 0.1 to 1 s) and programmable automatic reclosing system

 The 0.03 A sensitivity adjustment cancels the delay for a specific period of time, IEC 60947-2, annex M
 C/D curve circuit breaker with 6 kA cut off power (EN 60898). Please contact us for other specifications.

 Delivery time: [*] immediate
 [x] working weeks
 [c] consult



Set composed of: Earth leakage relay with built-in circuit breaker + WG Transformer



RECmaxLPD, Self-reclosing earth leakage relay with circuit breaker, used with an external earth leakage transformer

Type	Code	IΔn	Poles
2 Poles, C Curve			
RECmaxLPd-C2-6	[1] P2A110.	6 A	2
RECmaxLPd-C2-10	[1] P2A111.	10 A	2
RECmaxLPd-C2-16	[1] P2A112.	16 A	2
RECmaxLPd-C2-20	[1] P2A113.	20 A	2
RECmaxLPd-C2-25	[1] P2A114.	25 A	2
RECmaxLPd-C2-32	[1] P2A115.	32 A	2
RECmaxLPd-C2-40	[1] P2A116.	40 A	2
RECmaxLPd-C2-50	[1] P2A117.	50 A	2
RECmaxLPd-C2-63	[1] P2A118.	63 A	2
4 Poles, C Curve			
RECmaxLPd-C4-6	[1] P2A120.	6 A	4
RECmaxLPd-C4-10	[1] P2A121.	10 A	4
RECmaxLPd-C4-16	[1] P2A122.	16 A	4
RECmaxLPd-C4-20	[1] P2A123.	20 A	4
RECmaxLPd-C4-25	[1] P2A124.	25 A	4
RECmaxLPd-C4-32	[1] P2A125.	32 A	4
RECmaxLPd-C4-40	[1] P2A126.	40 A	4
RECmaxLPd-C4-50	[1] P2A127.	50 A	4
RECmaxLPd-C4-63	[1] P2A128.	63 A	4

Type	Code	IΔn	Poles
2 Poles, D Curve			
RECmaxLPd-D2-6	[1] P2A130.	6 A	2
RECmaxLPd-D2-10	[1] P2A131.	10 A	2
RECmaxLPd-D2-16	[1] P2A132.	16 A	2
RECmaxLPd-D2-20	[1] P2A133.	20 A	2
RECmaxLPd-D2-25	[1] P2A134.	25 A	2
RECmaxLPd-D2-32	[1] P2A135.	32 A	2
RECmaxLPd-D2-40	[1] P2A136.	40 A	2
RECmaxLPd-D2-50	[1] P2A137.	50 A	2
RECmaxLPd-D2-63	[1] P2A138.	63 A	2
4 Poles, D Curve			
RECmaxLPd-D4-6	[1] P2A140.	6 A	4
RECmaxLPd-D4-10	[1] P2A141.	10 A	4
RECmaxLPd-D4-16	[1] P2A142.	16 A	4
RECmaxLPd-D4-20	[1] P2A143.	20 A	4
RECmaxLPd-D4-25	[1] P2A144.	25 A	4
RECmaxLPd-D4-32	[1] P2A145.	32 A	4
RECmaxLPd-D4-40	[1] P2A146.	40 A	4
RECmaxLPd-D4-50	[1] P2A147.	50 A	4
RECmaxLPd-D4-63	[1] P2A148.	63 A	4

Earth leakage relay with adjustable sensitivity (0.03 to 1 A), adjustable delay (by curve, INS/SEL, or defined time span from 0.1 to 1 s) and automatic programmable reclosing.

The 0.03 A sensitivity adjustment cancels the delay for a specific period of time, IEC 60947-2, annex M WGS-20/30 and WGC-25/35 earth leakage transformers

C/D curve circuit breaker with 6 kA cut off power (EN 60898). Please contact us for other specifications.

Programmable earth leakage relay with built-in transformer + motorized circuit breaker

Complete set formed by: Earth leakage relay + WG/WGC Transformer + RECmax MP / MT-FDE



RGU-10 MT, Reclosing earth leakage relay for motorized circuit breakers

Type	Code	IΔn	Delay	Communications	Nr. reclosures	Time between reclosures
RGU-10 MT	[*] P24642.	0,03 ... 30 A	0,02...10 s, INS, SEL	-	Programmable	Programmable
RGU-10C MT	[*] P24652.	0,03 ... 30 A	0,02...10 s, INS, SEL	RS-485	Programmable	Programmable

The delay is cancelled in all relays with a sensitivity adjustment of 0.03 A, IEC 60947-2, annex M.

(*1) INS, SEL trip curves, according to IEC 61008-1, for trigger coils with a trip time <0.02 s

Requires a WGS/WGC earth leakage transformer (not included). To operate with RECmax MP (In≤63 A), with MT-FDE (In>63 A).

To encode other parameters, see the table at the end of the section

CODIFICATION TABLE

RGU-10/C RAL / RGU-10/C MT

Code	Internal code										Delivery time		
	P	2	X	X	X	X	0	0	X	0	0	X	X
Power supply voltage		Standard (230 V _{AC})											
		110 V _{AC} (WRU-10 RAL / MT)											
		24...48 V _{AC} / 24...125 V _{DC} (RGU-10/C RAL RGU-10/C MT)											
	Certificate UL (Only RGU-10C MT 230 V _{AC})										0 7 2		

Delivery time: [*] immediate
 [x] working weeks
 [c] consult

Programmable earth leakage relay with built-in transformer + motorized circuit breaker

Complete set formed by: Earth leakage relay + RECmax MP / MT

WRU-10MT, Earth leakage relay with built-in transformer

Type	Code	Usefull diam.(mm)	IΔn	Delay	Nr reclosures	Time between reclosures
WRU-10-MT	[C] P24275.	28	0,03 ... 3 A 0,03 ... 30 A	0,02...10 s, INS, SEL (*1)	Programmable	Programmable

The delay is cancelled in all relays with a sensitivity adjustment of 0.03 A, IEC 60947-2, annex M. (*1) INS, SEL trip curves, according to IEC 61008-1, for trigger coils with a trip time < 0.02 s
Requires a WGS/WGC earth leakage transformer (not included). To operate with RECmax MP (In≤63 A), with MT-FDE (In>63 A), To encode other parameters, see the table at the end of the section

RECmaxMP, Motorized circuit breakers (up to 63 A)

Type	Code	IΔn	Poles	Type	Code	IΔn	Poles
2 Poles, C Curve				2 Poles, D Curve			
RECmax MP-C2-6	[1] P27110.	6 A	2	RECmax MP-D2-6	[1] P27130.	6 A	2
RECmax MP-C2-10	[1] P27111.	10 A	2	RECmax MP-D2-10	[1] P27131.	10 A	2
RECmax MP-C2-16	[1] P27112.	16 A	2	RECmax MP-D2-16	[1] P27132.	16 A	2
RECmax MP-C2-20	[1] P27113.	20 A	2	RECmax MP-D2-20	[1] P27133.	20 A	2
RECmax MP-C2-25	[1] P27114.	25 A	2	RECmax MP-D2-25	[1] P27134.	25 A	2
RECmax MP-C2-32	[1] P27115.	32 A	2	RECmax MP-D2-32	[1] P27135.	32 A	2
RECmax MP-C2-40	[1] P27116.	40 A	2	RECmax MP-D2-40	[1] P27136.	40 A	2
RECmax MP-C2-50	[1] P27117.	50 A	2	RECmax MP-D2-50	[1] P27137.	50 A	2
RECmax MP-C2-63	[1] P27118.	63 A	2	RECmax MP-D2-63	[1] P27138.	63 A	2
4 Poles, C Curve				4 Poles, D Curve			
RECmax MP-C4-6	[1] P27120.	6 A	4	RECmax MP-D4-6	[1] P27140.	6 A	4
RECmax MP-C4-10	[1] P27121.	10 A	4	RECmax MP-D4-10	[1] P27141.	10 A	4
RECmax MP-C4-16	[1] P27122.	16 A	4	RECmax MP-D4-16	[1] P27142.	16 A	4
RECmax MP-C4-20	[1] P27123.	20 A	4	RECmax MP-D4-20	[1] P27143.	20 A	4
RECmax MP-C4-25	[1] P27124.	25 A	4	RECmax MP-D4-25	[1] P27144.	25 A	4
RECmax MP-C4-32	[1] P27125.	32 A	4	RECmax MP-D4-32	[1] P27145.	32 A	4
RECmax MP-C4-40	[1] P27126.	40 A	4	RECmax MP-D4-40	[1] P27146.	40 A	4
RECmax MP-C4-50	[1] P27127.	50 A	4	RECmax MP-D4-50	[1] P27147.	50 A	4
RECmax MP-C4-63	[1] P27128.	63 A	4	RECmax MP-D4-63	[1] P27148.	63 A	4

Please contact us for more information about impulse input options
C/D curve circuit breakers with 6 kA cut off power (EN 60898). Please contact us for other specifications.

MT-FDE, Motorized circuit breaker for currents exceeding than 63 A

Type	Code	In (A)	Poles	weight (kg)
3 poles				
MT-FDE 80AIII	[1] P20D60.	80 A	3	2.9
MT-FDE 100AIII	[1] P20D61.	100 A	3	2.9
MT-FDE 125AIII	[1] P20D62.	125 A	3	2.9
MT-FDE 160AIII	[1] P20D63.	160 A	3	2.9
MT-FEE 250AIII	[1] P20E64.	250 A	3	3.8
4 poles				
MT-FDE 80A IV	[1] P20D70.	80 A	4	3.4
MT-FDE 100A IV	[1] P20D71.	100 A	4	3.4
MT-FDE 125A IV	[1] P20D72.	125 A	4	3.4
MT-FDE 160A IV	[1] P20D73.	160 A	4	3.4
MT-FEE 250A IV	[1] P20E74.	250 A	4	4.6

**WRGU-10-MTT, Full earth leakage and circuit breaker reclosing and protection unit, panel**

2 Poles

Type	Code	IΔn	Poles
2 poles, C curve			
WRGU-10MTT-C-2-6A	[1] P21810.	6 A	2
WRGU-10MTT-C-2-10A	[1] P21811.	10 A	2
WRGU-10MTT-C-2-16A	[1] P21812.	16 A	2
WRGU-10MTT-C-2-20A	[1] P21813.	20 A	2
WRGU-10MTT-C-2-25A	[1] P21814.	25 A	2
WRGU-10MTT-C-2-32A	[1] P21815.	32 A	2
WRGU-10MTT-C-2-40A	[1] P21816.	40 A	2
WRGU-10MTT-C-2-50A	[1] P21817.	50 A	2
WRGU-10MTT-C-2-63A	[1] P21818.	63 A	2

Type	Code	IΔn	Poles
4 poles, C curve			
WRGU-10MTT-C-4-6A	[1] P21820.	6 A	4
WRGU-10MTT-C-4-10A	[1] P21821.	10 A	4
WRGU-10MTT-C-4-16A	[1] P21822.	16 A	4
WRGU-10MTT-C-4-20A	[1] P21823.	20 A	4
WRGU-10MTT-C-4-25A	[1] P21824.	25 A	4
WRGU-10MTT-C-4-32A	[1] P21825.	32 A	4
WRGU-10MTT-C-4-40A	[1] P21826.	40 A	4
WRGU-10MTT-C-4-50A	[1] P21827.	50 A	4
WRGU-10MTT-C-4-63A	[1] P21828.	63 A	4

Certified and Approved by Telefónica

Earth leakage relay with adjustable sensitivity (0.03 A, up to 1 A), adjustable delay (with curve, INS/SEL, or by time, from 0.1 to 1 s) and automatic reclosing system, 15 attempts by default (earth leakage) and 2 by the circuit breaker

OVERCURRENT SELF-RECLOSING**Self-reclosing circuit breaker****RECmaxP, Motorized circuit breakers, up to 63 A**

Type	Code	IΔn	Poles
2 Poles, C Curve			
RECmax P-C2-6	[1] P28110.	6 A	2
RECmax P-C2-10	[1] P28111.	10 A	2
RECmax P-C2-16	[1] P28112.	16 A	2
RECmax P-C2-20	[1] P28113.	20 A	2
RECmax P-C2-25	[1] P28114.	25 A	2
RECmax P-C2-32	[1] P28115.	32 A	2
RECmax P-C2-40	[1] P28116.	40 A	2
RECmax P-C2-50	[1] P28117.	50 A	2
RECmax P-C2-63	[1] P28118.	63 A	2
4 Poles, C Curve			
RECmax P-C4-6	[1] P28120.	6 A	4
RECmax P-C4-10	[1] P28121.	10 A	4
RECmax P-C4-16	[1] P28122.	16 A	4
RECmax P-C4-20	[1] P28123.	20 A	4
RECmax P-C4-25	[1] P28124.	25 A	4
RECmax P-C4-32	[1] P28125.	32 A	4
RECmax P-C4-40	[1] P28126.	40 A	4
RECmax P-C4-50	[1] P28127.	50 A	4
RECmax P-C4-63	[1] P28128.	63 A	4

Type	Code	IΔn	Poles
2 Poles, D Curve			
RECmax P-D2-6	[1] P28130.	6 A	2
RECmax P-D2-10	[1] P28131.	10 A	2
RECmax P-D2-16	[1] P28132.	16 A	2
RECmax P-D2-20	[1] P28133.	20 A	2
RECmax P-D2-25	[1] P28134.	25 A	2
RECmax P-D2-32	[1] P28135.	32 A	2
RECmax P-D2-40	[1] P28136.	40 A	2
RECmax P-D2-50	[1] P28137.	50 A	2
RECmax P-D2-63	[1] P28138.	63 A	2
4 Poles, D Curve			
RECmax P-D4-6	[1] P28140.	6 A	4
RECmax P-D4-10	[1] P28141.	10 A	4
RECmax P-D4-16	[1] P28142.	16 A	4
RECmax P-D4-20	[1] P28143.	20 A	4
RECmax P-D4-25	[1] P28144.	25 A	4
RECmax P-D4-32	[1] P28145.	32 A	4
RECmax P-D4-40	[1] P28146.	40 A	4
RECmax P-D4-50	[1] P28147.	50 A	4
RECmax P-D4-63	[1] P28148.	63 A	4

Please contact us for more information about impulse input options

C/D curve circuit breakers with 6 kA cut off power (EN 60898). Please contact us for other specifications.

Programmable reclosing relay + motorized switch

Complete set formed by: RRM + MT-E62/E64

**RRM, Overcurrent tripping relay with self-reclosing system**

Type	Code	Communications	Nr. reclosures	Time between reclosures
RRM-P	[*] P25130.	-	Adjustable: 0,1,2,4,6,8	0.5,1,2,3,4,5 min
RRM-C	[*] P25131.	RS-485	Adjustable: 0,1,2,4,6,8	0.5,1,2,3,4,5 min

To operate with motorized circuit breaker. Please contact us for more information

Dimensions

RGU-10 / CBS-4

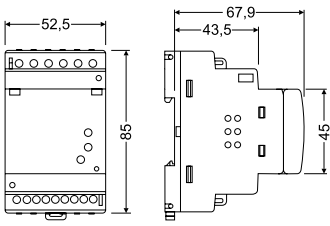

RRM

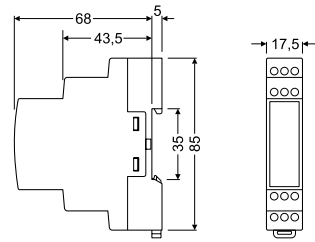

**RECmax
2 poles**

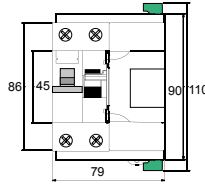

4 poles

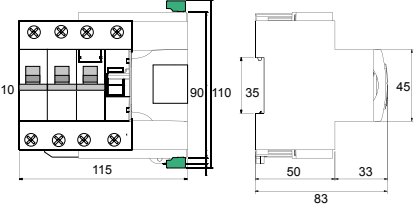

REC3 2P / REC3C 2P

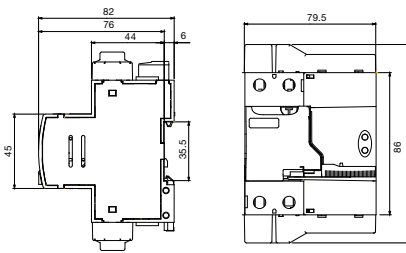

REC3 4P / REC3C 4P

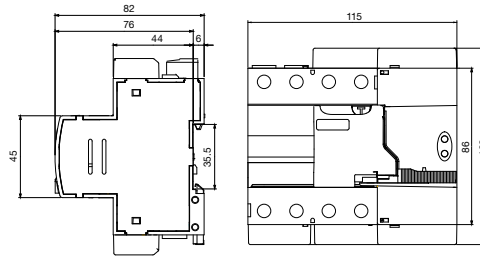

MCB.P

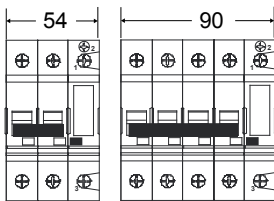

RECmax CVM

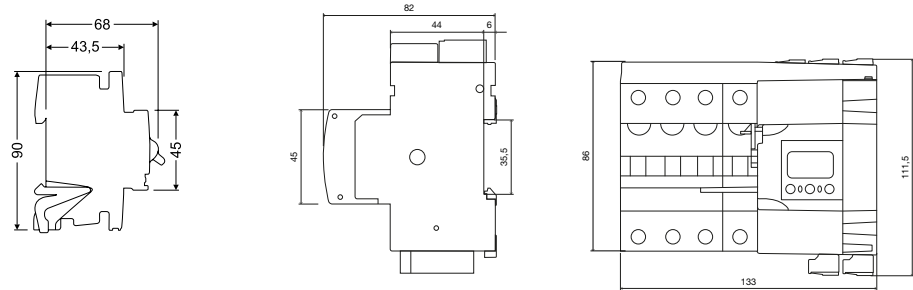

WRGU-10-MTT P2

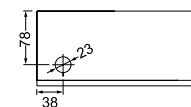
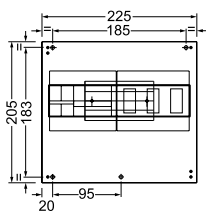
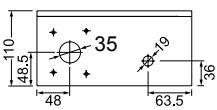

WRGU-10-MTT P4

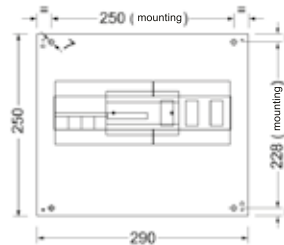
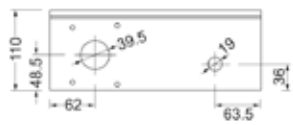

WRU-10

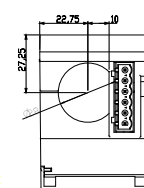
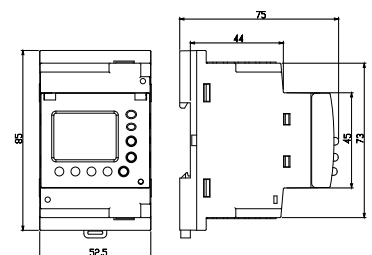

Relays and control elements



IMD-2R, Monitoring relay for offline insulation

Type	Code	Description
IMD-2R	[*] P33020.	Monitoring relay for offline insulation. It controls and monitors the insulation resistance of the receivers that are occasionally disconnected from the electrical network



TB, Bacon control equipment

Type	Code	Description
TB-3	[*] P30102.	Programmable power between 15 ... 225 W Control of one circuit (BACON). Luminosity level controlled by means of a photocell (included with the equipment). 1 alarm relay for failure of circuit or photocell



RV, Voltage detector relays (AC), DIN rail

Type	Code	System	Phase sequence
RV, Voltage detector relays (AC), DIN rail			
RV-M	[*] P30701.	Single-phase 230 V	-
RV-T	[*] P30702.	Three-phase 400/230 V	*
RV-TS	[*] P30704.	Three-phase 400/230 V	-



WI, Current detector relay (AC), DIN rail

Type	Code	Trip time (adjustable)	Margin of setting (adjustable)
WI, Current detector relay (AC), DIN rail			
WI/005-30	[*] P32011.	0,5 ... 30 s	0,5 ... 5 A
WI/010-30	[*] P32012.	0,5 ... 30 s	1 ... 10 A
WI/020-30	[*] P32013.	0,5 ... 30 s	2 ... 20 A
WI/050-30	[*] P32014.	0,5 ... 30 s	5 ... 50 A
WI/100-30	[*] P32015.	0,5 ... 30 s	10 ... 100 A
WI/TS	[*] P32010.	0,5 ... 30 s	s / transf. ... / 5 A



CDR, Station with 8 current relays, display and RS-485 communications

Type	Code	Description
CDR-8	[*] P32111.	8 current relays station, display, RS-485 communications. Measurement range 0,03 to 63 A

Measurement range 0.03 to 6.3 A with external transformer, model WGS/WG. Please contact us 0.3 to 63 A Measurement range with External transformer, model WGSP/WGP. Please contact us for more information

Dimensions

IMD-2R

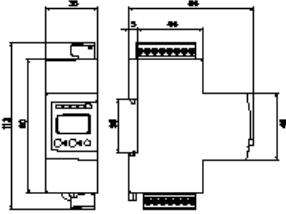

TB-3

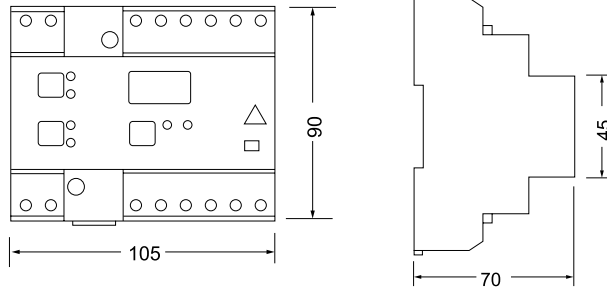

RV

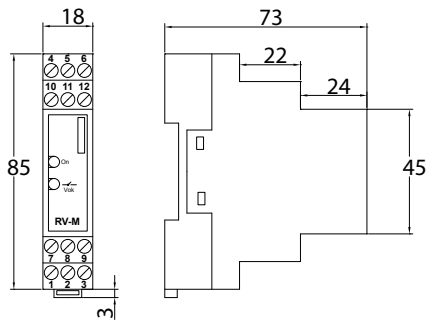

WI

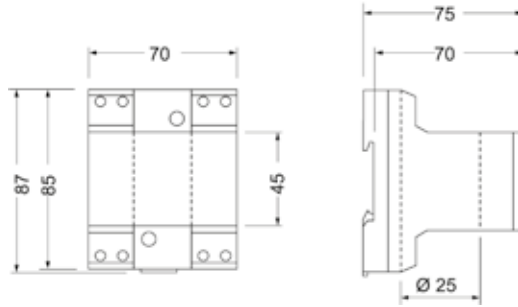

CDR-8

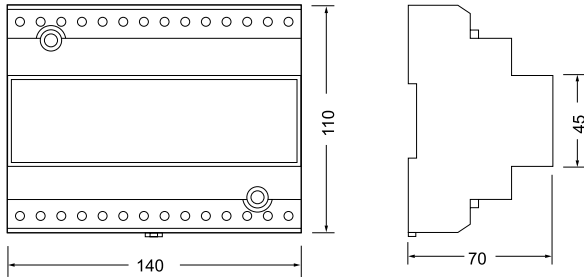

Protection current transformer

TRP model selection table, according to:
 Primary current intensity
 Maximum wiring diameter
 Assigned VA power
 Assigned accuracy/protection class

	TRP 40	TRP 60	TRP 80	TRP 100	TRP 140	TRP 180
	5P10-5P20	5P10-5P20	5P10-5P20	5P10-5P20	5P10-5P20	5P10-5P20
	Potencia (VA)			Power (VA)		
100/5	5					
150/5	5	2.5				
200/5	10	2.5				
250/5	10	5	5			
300/5	15	5	5			
400/5	20	7.5	7.5			
500/5	25	10	10			
600/5	inner	10	10	inner Ø 100 mm		
750/5	Ø 40 mm	15	15	5	inner	
800/5		15	15	5	Ø 140 mm	
1 000/5		20	20	7.5	5	
1 200/5		Cable inner	25	10	5	inner
1 250/5		Ø 60 mm	25	10	5	Ø 180 mm
1 500/5			30	10	10	5
1 600/5			30	15	10	5
1 800/5			35	15	10	5
2 000/5			inner	15	10	7.5
2 500/5			Ø 80 mm	20	10	10
3 000/5				25	15	10
4 000/5					15	15
5 000/5						15

TRP, Protection transformers encapsulated in resin

Type	TRP40-5P10	TRP40-5P20	TRP60-5P10	TRP60-5P20								
Usefull diam. (mm)	Ø 40 mm		Ø 60 mm									
Accuracy	5P10		5P20									
A	VA	Code	kg	VA	Code	kg	VA	Code	kg			
100	5	[4] P50311.	5,00	5	[4] P50211.	9,00						
150	5	[4] P50312.	5,00	5	[4] P50212.	9,00	2.5	[4] P50321.	2,60	2.5	[4] P50221.	4,20
200	10	[4] P50313.	5,00	10	[4] P50213.	9,00	2.5	[4] P50322.	2,70	2.5	[4] P50222.	4,20
250	10	[4] P50314.	5,00	10	[4] P50214.	9,00	5	[4] P50323.	2,70	5	[4] P50223.	4,30
300	15	[4] P50315.	5,10	15	[4] P50215.	9,10	5	[4] P50324.	2,70	5	[4] P50224.	4,70
400	20	[4] P50316.	5,10	20	[4] P50216.	9,20	7.5	[4] P50325.	2,80	7.5	[4] P50225.	4,90
500	25	[4] P50317.	5,20	25	[4] P50217.	9,30	10	[4] P50326.	2,80	10	[4] P50226.	5,10
600							10	[4] P50327.	2,90	10	[4] P50227.	5,20
750							15	[4] P50328.	3,00	15	[4] P50228.	5,30
1000							20	[4] P50329.	3,20	20	[4] P50229.	5,50

Type	TRP80-5P10	TRP80-5P20	TRP100-5P10	TRP100-5P20								
Usefull diam. (mm)	ø 80 mm		ø 100 mm									
Acuracy	5P10		5P20									
A	VA	Code	kg	VA	Code	kg	VA	Code	kg			
250	5	[4] P50331.	3,20	5	[4] P50231.	5,60						
300	5	[4] P50332.	3,30	5	[4] P50232.	5,70						
400	7,5	[4] P50333.	3,30	7,5	[4] P50233.	5,80						
500	10	[4] P50334.	3,40	10	[4] P50234.	5,90						
600	10	[4] P50335.	3,50	10	[4] P50235.	6,10						
750				5	[4] P50341.	3,40	5	[4] P50241.	5,60			
800	15	[4] P50336.	3,60	15	[4] P50236.	6,20						
1000	20	[4] P50337.	3,70	20	[4] P50237.	6,30	7,5	[4] P50342.	3,40	7,5	[4] P50242.	5,80
1200	25	[4] P50338.	3,80	25	[4] P50238.	6,60	10	[4] P50343.	3,40	10	[4] P50243.	5,90
1500	30	[4] P50339.	4,00	30	[4] P50239.	6,90	10	[4] P50344.	3,50	10	[4] P50244.	6,10
2000							15	[4] P50346.	3,70	15	[4] P50246.	6,40
2500							15	[4] P50347.	3,90	15	[4] P50247.	6,80
3000							20	[4] P50348.	4,30	20	[4] P50248.	7,30

Type	TRP140-5P10	TRP140-5P20	TRP180-5P10	TRP180-5P20								
Usefull diam. (mm)	ø 140 mm		ø 180 mm									
Acuracy	5P10		5P20									
A	VA	Code	kg	VA	Code	kg	VA	Code	kg			
1000	5	[4] P50351.	3,70	5	[4] P50251.	6,20						
1250	5	[4] P50352.	3,80	5	[4] P50252.	6,40						
1500	10	[4] P50353.	3,90	10	[4] P50253.	6,60	5	[4] P50361.	4,50	5	[4] P50261.	7,60
2000	10	[4] P50354.	4,20	10	[4] P50254.	7,10	7,5	[4] P50362.	4,50	7,5	[4] P50262.	7,60
2500	10	[4] P50355.	4,50	10	[4] P50255.	7,50	10	[4] P50363.	5,00	10	[4] P50263.	8,50
3000	15	[4] P50356.	4,60	15	[4] P50256.	8,00	10	[4] P50364.	5,20	10	[4] P50264.	8,90
4000	15	[4] P50357.	5,20	15	[4] P50257.	8,90	15	[4] P50365.	5,70	15	[4] P50265.	9,70
5000							15	[4] P50366.	6,20	15	[4] P50266.	10,60

TRP

Code	Internal code					
P 5 X X X X 0 0 X						
					Delivery time	+ €
Secondary current	Standard (.../ 5 A)	0	-			-
	... / 1A	1	5			+20 %



TRM, Measure current transformers encapsulated in resin, see section Measurements and control / Measuring current transformers and shunts

Measuring and testing equipments for substations



GETEST, Indirect earth contact simulator

Type	Code	Description
GETEST 5...50A	[C] P6012300A0000	Indirect earth contact simulator 5 ...50 A, GETEST, includes PDA
Trolley GETEST	[C] P6990A.	Transport trolley GETEST

Includes the CIRCUTOR laboratory certificate



CR, Relay tester

Type	Code	Description
Relay tester		
CR-50	[C] P6021100A0000	Relay tester 50 A (carrying case version)
CR-100	[C] P6021200A0000	Relay tester 100 A (carrying case version)
CR-250	[C] P6021300A0000	Relay tester 250 A

Accessories

Trafo 2500 para CR-250	[C] P69903.	Transformer 2500 A for CR-250
Cable 1,5M/2500A	[C] P69902.	Cable: Lenght 1,5 m / 2500 A
MPC-CR	[C] P69901.	Transport trolley CR250

Includes the CIRCUTOR laboratory certificate



OT2, Dielectric strenght tester

Type	Code	Description
OT2-60 D	[C] P6031200A0000	Dielectric strenght tester for insulating oil 60 kV

Includes the CIRCUTOR laboratory certificate



MH, Microohmmeter

Type	Code	Description
MH-10	[C] P6071100A0000	Microohmmeter (Thomson Bridge)
MH-10/100u	[C] P6071400A0000	Microohmmeter 10 / 100 A

Includes the CIRCUTOR laboratory certificate

MD, Megaohmmeters

Type	Code	Description
MD-5060e	[C] P6052100A0000	Digital megaohmmeter 5 kV (with memory and communications)
MD-10kVe	[C] P6052200A0000	Digital megaohmmeter 10 kV

TL, Earth resistance meter

Type	Code	Description
TL-6e	[C] P6062200A0000	4-way earth resistance meter

Code	Internal Code	
P 6 X X X X 0 0 X		
	↑	Delivery time + €
Certificate	ENAC calibration certificate	E C Consult

Delivery time: [*] immediate
 [x] working weeks
 [c] consult

PI-23, High voltage clamps

Type	Code	Description	A (max.)	Usefull diam.(mm)
PI-23 50HZ	[*] M80132.	PI-23 + case	400	25
PI-23 60HZ	[*] M801320010000	PI-23 + case	400	25



Reactors for filtering, see section **Reactive energy compensation and harmonic filtering/**

Low voltage capacitors and reactors

In-line reactors **Reactive energy compensation and harmonic filtering/Harmonic filters**

Power factor correction and harmonic filtering

Table: Selection of the reactive energy compensation unit.....	117
GUIDE OF SELECTION FOR HARMONIC OR DISTURBANCE FILTERING EQUIPMENT.....	117
Reactive energy regulators	
computer Smart III, Three-phase power factor regulators. Regulation, measurement, leakage control and communications.....	118
computer Max P&P, Power factor regulators.....	118
computer one, Power factor relay 1 step, IP 00.....	118
computer two, Power factor regulator 2 step, IP 00.....	118
DIR2, Power factor relay 1 step. din rail.....	118
Computer SMART III-Fast, Power factor regulators for static switching.....	119
computer Max-f, Power factor regulators for static switching.....	119
Low voltage power capacitors	
TCLZ, IP 54 covers for CLZ-FP.....	120
CLZ-FP-M, Single-phase tubular power capacitor.....	120
CLZ-FP23 HD, Tubular power capacitor.....	120
CLZ-FP48 HD, Tubular power capacitor.....	121
CLZ-FP24-60 HD, Three-phase tubular power capacitor, 60 Hz.....	122
CLZ-FP60-60 HD, Three-phase tubular power capacitor, 60 Hz.....	123
MC / CMC, Contactors with fast discharge resistor.....	123
RD, Fast discharging resistors.....	123
ELEB, CSB coils.....	123
IR, current limiting impedances.....	123
CSB, Power capacitors for LV.....	124
CSB-2V, Power capacitors for LV dual voltage.....	124
CFB, Power capacitors for harmonic filtering (for FR).....	125
RX / RBX, Reactors III for detuned static filters.....	126
RX / RBX-60Hz, Reactors III for detuned static filters.....	126
CFB-6B, Power capacitors for harmonics filters with static switching operation of the FRE series.....	127
RE-RBE, Reactors III for detuned static filters with FRE static switching.....	127
CV, Power capacitors for LV.....	128
CQ, Power capacitors for LV.....	128
CSB-A, Fixed capacitors with automatic protection 50 Hz.....	128
CSB-M, Power capacitors with circuit breaker protection.....	129
CSB-F, Power capacitors with fuse protection.....	129
OPTIM-FRF, Fixed capacitors with rejection reactance of $p = 7\%$	130
OPTIM-FRM, Fixed capacitors with rejection reactance of $p = 7\%$	130
CLP-C, CLZ Capacitor with circuit breaker and contactor.....	130
CLP, Power capacitor with circuit breaker.....	130
ACF, CSB capacitor with contactor and fuses.....	131
Low voltage capacitor banks	
OPTIM P&P, Automatic capacitor banks, 2.5 to 1600 kvar.....	134
OPTIM HYB, Semi-fast hybrid automatic capacitor banks with phase-by-phase compensation for unbalanced networks.....	135
OPTIM FRF, Fixed capacitors with rejection reactance of $p = 7\%$	136
OPTIM FRM, Fixed capacitors with rejection reactance of $p = 7\%$	136
OPTIM FR P&P, Automatic capacitor banks with rejection filters (contactors switching).....	136
OPTIM EMS, Automatic capacitor banks with static contactor.....	138
OPTIM EMK, Automatic capacitor banks with static contactor.....	139
OPTIM FRE, Automatic capacitor banks with rejection filters (static contactor).....	140
Harmonic filters	
AFQevo, Active multifunction filter.....	145
LR, Filter reactors for power converters (network side).....	145
SINUS, Filter for PWM.....	146
LCL, Harmonic filters for power converters.....	146
LCL-TH, Filter for elevators.....	146
FB3, Third harmonic blocking filter for 50 Hz network.....	147
FAR-Q, Hybrid absorption filters.....	147
Capacitor and MV accessories	
CHV-M, Single-phase MV power capacitors (indoor and outdoor use).....	149
CHV-T, Three-phase MV power capacitors.....	150
LVC, Three-phase contactor for MV capacitors.....	151
RMV, Choke reactors for MV capacitor banks.....	151
MV Automatic capacitor banks	

OUTSTANDING PRODUCTS

computer SMART III



Power factor regulator

OPTIM P&P



Automatic capacitor bank with Plug&Play regulator

OPTIM HYB



Hybrid automatic capacitor bank, phase-by-phase compensation

OPTIM FRES / OPTIM FRE



Automatic capacitor banks with rejection filters (static contactor)

Page

118

134

135

140

Table: Selection of the reactive energy compensation unit

Page

Multiple loads	Slow variations	without harmonics	OPTIM P&P		134		
		with harmonics	OPTIM FR P&P	Elimination of resonances	136		
			FAR-Q	Absorption of harmonics	147		
	Slightly quick variations	without harmonics	OPTIM HYB	Hybrid and phase-to-phase compensation for unbalanced networks	135		
	Quick variations	without harmonics		OPTIM EMS-C		138	
				OPTIM EMK		139	
		with harmonics	OPTIM FRE	Elimination of resonances	140		
		Fixed individual compensation	without harmonics	Fuse protection	CSB-F	Transformadors	129
				Fuse and contactor protection	ACF	Medium and high-power motors	131
	Circuit breaker protection			CSB-M	Medium-power transformers	129	
CLP				Low-power motors	130		
Circuit breaker and contactor protection	CLP-C			Low-power motors	130		
Circuit breaker protection	CSB-A			High power transformers	128		
With reactive power relay	OPTIM 1-1A			Small installations, individual loads	134		
With harmonics	Fuse protection	OPTIM FRF	Elimination of resonances	136			
	Circuit breaker protection	OPTIM FRM	Elimination of resonances	136			

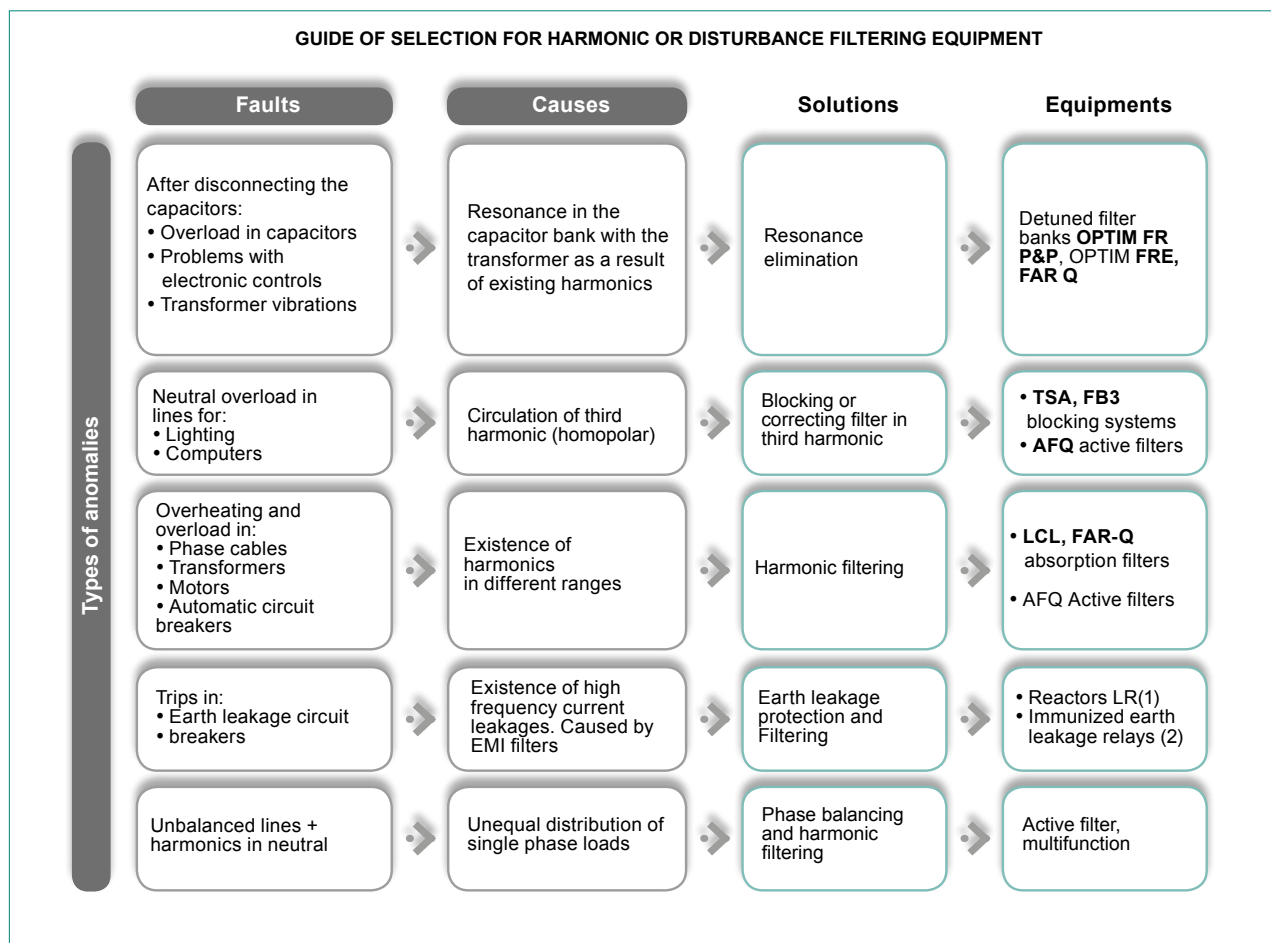

Reactive energy regulators



computer Smart III, Three-phase power factor regulators. Regulation, measurement, leakage control and communications

Type	Code	Power supply	Measurement Range (V)	I Δ n/Icap.	Nr steps	Alarm relay	Communi-cations	Size (mm) width xheight xdepth
computer Smart III 6	[*] R13851.	100...520 Vac	100...520	yes	6	1	RS-485	144x144x71
computer Smart III 12	[*] R13862.	100...520 Vac	100...520	yes	12	1	RS-485	144x144x71
computer SMARTIII 14	[*] R13864.	150...400 Vac	100...520	yes	14	1	RS-485	144x144x71



computer Max P&P, Power factor regulators

Type	Code	Power supply	Measurement Range (V)	Nr steps	Alarm relay	Size (mm) width xheight xdepth
computer Max P&P 6	[*] R10871.	400 Vac	400	6	1	144x144x62
computer Max P&P 12	[*] R10872.	400 Vac	400	12	1	144x144x62
computer Max P&P 6	[*] R108710020000	230 Vac	230	6	1	144x144x62
computer Max P&P 12	[*] R108720020000	230 Vac	230	12	1	144x144x62
computer Max P&P 6	[*] R108710040000	480 Vac	480	6	1	144x144x62
computer Max P&P 12	[*] R108720040000	480 Vac	480	12	1	144x144x62

* Associated with the last contactor relay.



computer one, Power factor relay 1 step, IP 00

Type	Code	Power supply	Measurement Range (V)	Input current	Nr steps	Alarm relay	Size (mm) width xheight xdepth
Computer One	[*] R13810.	230 Vac	400	.../250 mA	1	0	90x90x5

Requires the use of MC transformers (not included). See section M - Measuring current transformers and shunts



computer two, Power factor regulator 2 step, IP 00

Type	Code	Power supply	Measurement Range (V)	Input current	Nr steps	Alarm relay	Programa	Size (mm) width xheight xdepth
Computer two	[*] R13820.	230 Vac	400	.../250 mA	2	0	1.1	90x90x5
Computer two	[*] R13821.	230 Vac	400	.../250 mA	2	0	1.1,5	90x90x5
Computer two	[*] R13822.	230 Vac	400	.../250 mA	2	0	1.2	90x90x5
Computer two	[*] R13823.	230 Vac	400	.../250 mA	2	0	1.2,5	90x90x5

Requires the use of MC transformers (not included). See section M - Measuring current transformers and shunts



DIR2, Power factor relay 1 step, din rail

Type	Code	Power supply	Input current	Nr steps	Alarm relay	Size (mm) width xheight xdepth
DIR2	[*] R11211.	400 Vac	.../250 mA	1	0	35x85x73

Requires the use of MC transformers (not included). See section M - Measuring current transformers and shunts

FAST POWER FACTOR REGULATOR (STATIC SWITCHING)



Computer SMART III-Fast, Power factor regulators for static switching

Type	Code	Power supply	Measurement Range (V)	Switching unit	I Δ n/Icap.	Nr steps	Alarm relay	Communications	Size (mm) width x height x depth
computer SMART III F6-12Vdc	[*] R13953.	100...520 Vac	100...520	EMB-2PH	yes	6	1	RS-485	144x144x71
computer SMART III F12-12Vdc	[*] R13964.	100...520 Vac	100...520	EMB-2PH	yes	12	1	RS-485	144x144x71
Computer Smart III Fast 6	[*] R13951.	100...520 Vac	100...520	EMF / EMB	yes	6	1	RS-485	144x144x71
Computer Smart III Fast 12	[*] R13962.	100...520 Vac	100...520	EMF / EMB	yes	12	1	RS-485	144x144x71



computer Max-f, Power factor regulators for static switching

Type	Code	Power supply	Measurement Range (V)	Switching unit	Nr steps	Alarm relay	Size (mm) width x height x depth
Computer Max 6f	[*] R10851.	400 Vac	400	EMF / EMB	6	0	144x144x62
Computer Max 12f	[*] R10862.	400 Vac	400	EMF / EMB	12	0	144x144x62
computer MAX 6f_12Vdc	[*] R10853.	400 Vac	400	EMB-2PH	6	0	144x144x62
computer MAX 12f_12Vdc	[*] R10864.	400 Vac	400	EMB-2PH	12	0	144x144x62

DIMENSIONS

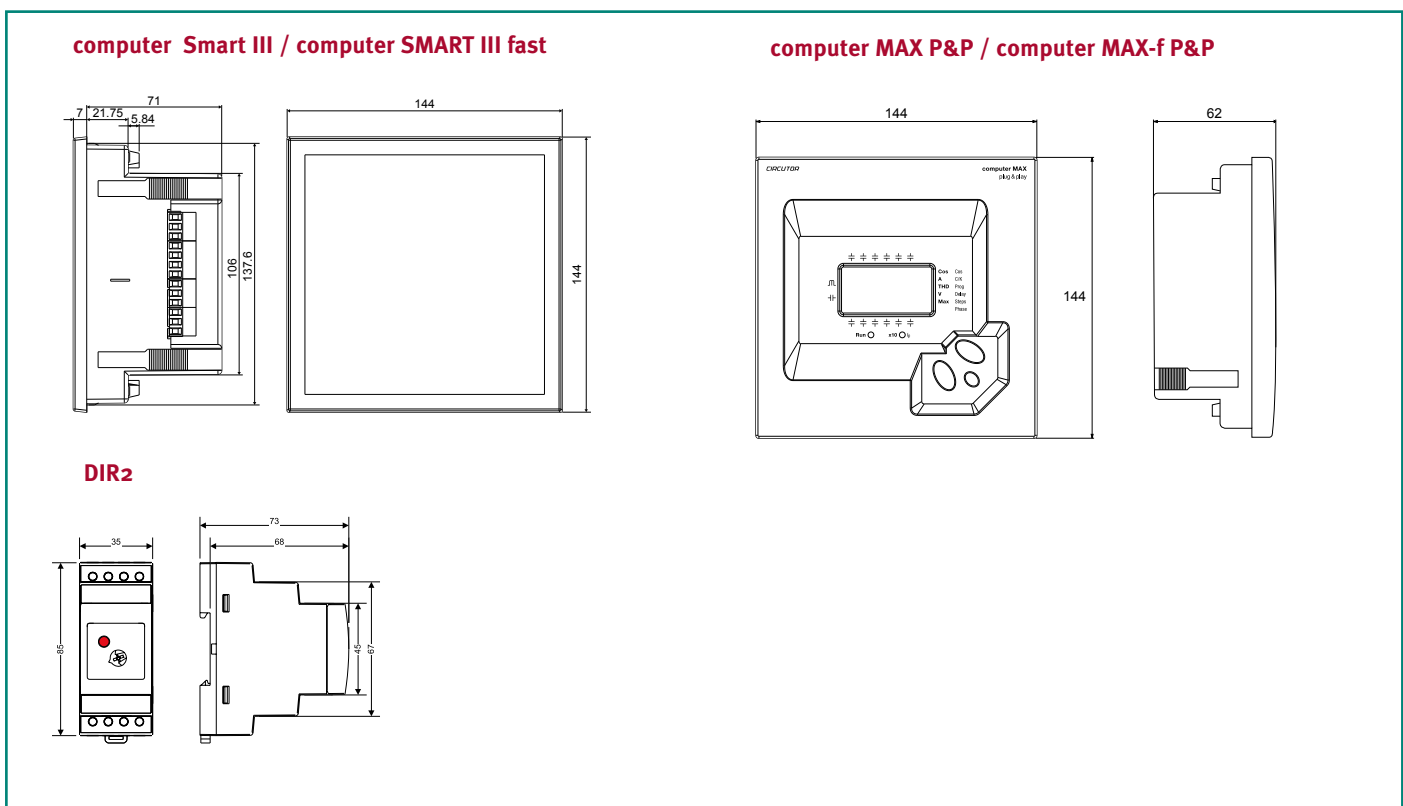

Low voltage power capacitors

TCLZ, IP 54 covers for CLZ-FP

Type	Code
TCLZ-FPT65	[*] R29915.
TCLZ-FPT50	[*] R29916.
TCLZ-FP85	[*] R29911.
TCLZ-FP116	[*] R29917.
TCLZ-FP100	[*] R29918.

CLZ-FP-M, Single-phase tubular power capacitor

230 V, con regleta de conexión

Type	Code	230 V kvar	240 V kvar	Hz	dia.x alt. (mm)	weight (kg)	Cover (opc.)
CLZ-FP-M-23/2,5	[1] R205C4.	2.5	2.7	50	85 x 245	1,00	1
CLZ-FP-M-23/5	[1] R205C8.	5	5.4	50	85 x 245	1,20	1
CLZ-FP-M-23/7,5	[1] R205CM.	7.5	8.2	50	116 x 245	1,70	2
CLZ-FP-M-23/10	[1] R205CN.	10	10.9	50	116 x 245	2,00	2



CLZ-FP23 HD, Tubular power capacitor

Type	Code	220 V kvar	230 V kvar	Hz	dia.x alt. (mm)	weight (kg)	Cover (opc.)	Terminal
CLZ-FPT-23/1,25-HD	[C] R2H511.	1.15	1.25	50	63,5 x 127	0,44	-	F
CLZ-FPT-23/2,5-HD	[C] R2H812.	2.3	2.5	50	63,5 x 175	0,90	-	F
CLZ-FP-23/5-HD	[C] R2H516.	4.6	5	50	85 x 175	1,10	1	A
CLZ-FP-23/6,25-HD	[C] R2H517.	5.7	6.25	50	85 x 245	1,20	1	A
CLZ-FP-23/7,5-HD	[C] R2H518.	6.8	7.5	50	85 x 245	1,30	1	A
CLZ-FP-23/10-HD	[C] R2H51B.	9.15	10	50	100 x 245	2,00	7	A
CLZ-FP-23/12,5-HD	[C] R2H51D.	11.4	12.5	50	100 x 245	2,30	7	A
CLZ-FP-23/15-HD	[C] R2H51E.	13.75	15	50	116 x 245	2,40	2	B



Type	Code	400 V kvar	440 V kvar	Hz	dia.x alt. (mm)	weight (kg)	Cover (opc.)	Terminal
CLZ-FPT-44/1,25-HD	[C] R2H541.	1	1.25	50	63,5 x 98	0,34	-	F
CLZ-FPT-44/2,5-HD	[*] R2H542.	2	2.5	50	63,5 x 127	0,44	-	F
CLZ-FPT-44/3-HD	[C] R2H543.	2.5	3	50	63,5 x 127	0,44	-	F
CLZ-FPT-44/3,75-HD	[C] R2H544.	3	3.75	50	63,5 x 127	0,44	-	F
CLZ-FPT-44/5-HD	[*] R2H546.	4	5	50	63,5 x 175	0,50	-	F
CLZ-FPT-44/6,25-HD	[*] R2H547.	5	6.25	50	63,5 x 175	0,70	-	F
CLZ-FPT-44/7,5-HD	[*] R2H848.	6.25	7.5	50	63,5 x 202	0,90	-	F
CLZ-FP-44/10-HD	[*] R2H54B.	8	10	50	85 x 245	1,00	1	A
CLZ-FP-44/12,5-HD	[*] R2H54D.	10	12.5	50	85 x 245	1,20	1	A
CLZ-FP-44/15-HD	[*] R2H54E.	12.5	15	50	85 x 245	1,40	1	A
CLZ-FP-44/18,2-HD	[C] R2H54G.	15	18.2	50	100 x 245	1,90	7	A
CLZ-FP-44/20-HD	[*] R2H54J.	16	20	50	100 x 245	2,00	7	A
CLZ-FP-44/25-HD	[*] R2H54L.	20	25	50	100 x 245	2,20	7	B
CLZ-FP-44/30-HD	[*] R2H54N.	25	30	50	116 x 245	2,50	2	B
CLZ-FP-44/28-HD	[] R2H54M.	23	28	50	116 x 245	2,40	2	B
CLZ-FP-44/40-HD	[C] R2H54R.	32	40	50	136 x 261	3,80	-	B
CLZ-FP-44/50-HD	[*] R2H54S.	40	50	50	136 x 355	5,90	-	C

Type	Code	440 V kvar	460 V kvar	Hz	dia.x alt. (mm)	weight (kg)	Cover (opc.)	Terminal
CLZ-FPT-46/6,25-HD	[*] R2H857.	5.7	6	50	63,5 x 127	0,70	-	F
CLZ-FP-46/12,5-HD	[*] R2H55D.	11.4	12.5	50	85 x 245	1,40	1	A
CLZ-FP-46/15-HD	[*] R2H55E.	13.7	15	50	85 x 245	1,60	1	A
CLZ-FP-46/19-HD	[*] R2H55H.	17.4	19	50	100 x 245	2,20	7	A
CLZ-FP-46/25-HD	[*] R2H55L.	22.9	25	50	116 x 245	2,50	2	B
CLZ-FP-46/30-HD	[*] R2H55N.	27.4	30	50	136 x 220	3,80	-	B

All models are of the inert gas type, except for those with a 63.5 mm diameter and 136x355 mm size. The dimensions (dxh) are shown for the tube only. Please consult the dimensions drawing at the end of this section for more information about the actual dimensions. Terminal: maximum cross-section of type A cables: 16 mm², type B: 25 mm², type C: 35 mm², F: Faston 6.3x0.8 mm and 12 A maximum current

CLZ-FP48 HD, Tubular power capacitor

Type	Code	460 V kvar	480 V kvar	Hz	dia.x alt. (mm)	weight (kg)	Cover (opc.)	Terminal
CLZ-FPT-48/2,5-HD	[] R2H862.	2.3	2.5	50	63,5 x 127	0,90	-	F
CLZ-FPT-48/5-HD	[] R2H866.	4.6	5	50	63,5 x 175	1,10	-	F
CLZ-FPT-48/7,5-HD	[] R2H868.	6.9	7.5	50	63,5 x 202	1,30	-	F
CLZ-FP-48/10-HD	[] R2H56B.	9.2	10	50	85 x 245	1,10	1	A
CLZ-FP-48/12,5-HD	[] R2H56D.	11.5	12.5	50	85 x 245	1,30	1	A
CLZ-FP-48/15-HD	[] R2H56E.	13.8	15	50	85 x 245	1,50	1	A
CLZ-FP-48/20-HD	[] R2H56J.	18.4	20	50	100 x 245	2,20	7	A
CLZ-FP-48/25-HD	[] R2H56L.	23	25	50	116 x 245	2,40	2	B
CLZ-FP-48/30-HD	[] R2H56N.	27.6	30	50	116 x 245	2,60	2	B
CLZ-FP-48/40-HD	[] R2H56R.	36.75	40	50	136 x 261	4,50	-	B

Type	Code	500 V kvar	525 V kvar	Hz	dia.x alt. (mm)	weight (kg)	Cover (opc.)	Terminal
-	[C] R2H578.	-	-	-	-	-	-	-
CLZ-FPT-52/2,5-HD	[C] R2H872.	2.3	2.5	50	63,5 x 127	0,70	-	F
CLZ-FPT-52/3-HD	[C] R2H873.	2.7	3	50	63,5 x 127	0,70	-	F
CLZ-FPT-52/4-HD	[C] R2H875.	3.6	4	50	63,5 x 175	0,70	-	F
CLZ-FPT-52/5-HD	[*] R2H876.	4.5	5	50	63,5 x 175	0,80	-	F
CLZ-FPT-52/6,25-HD	[C] R2H877.	5.7	6.25	50	63,5 x 202	0,80	-	F
CLZ-FPT-52/7,5-HD	[C] R2H878.	6.8	7.5	50	63,5 x 202	0,90	-	F
CLZ-FP-52/8-HD	[C] R2H579.	7.25	8	50	85 x 175	1,10	1	A
CLZ-FP-52/10-HD	[*] R2H57B.	9.1	10	50	85 x 245	1,20	1	A
CLZ-FP-52/12,5-HD	[*] R2H57D.	11.3	12.5	50	85 x 245	1,40	1	A
CLZ-FP-52/15-HD	[*] R2H57E.	13.6	15	50	85 x 245	1,50	1	A
CLZ-FP-52/20-HD	[*] R2H57J.	18.15	20	50	100 x 245	2,30	7	A
CLZ-FP-52/25-HD	[*] R2H57L.	22.7	25	50	116 x 245	2,50	2	B
CLZ-FP-52/30-HD	[*] R2H57N.	27.2	30	50	116 x 245	3,10	2	B
CLZ-FP-52/40-HD	[C] R2H57R.	36.3	40	50	136 x 261	3,20	-	B
CLZ-FP-52/50-HD	[C] R2H57S.	45.4	50	50	136 x 355	5,90	-	C

Type	Code	660 V kvar	690 V kvar	Hz	dia.x alt. (mm)	weight (kg)	Cover (opc.)	Terminal
CLZ-FPT-69/2,5-HD	[C] R2H892.	2.3	2.5	50	63,5 x 127	0,70	-	F
CLZ-FPT-69/5-HD	[C] R2H896.	4.6	5	50	63,5 x 175	0,80	-	F
CLZ-FP-69/7,5-HD	[C] R2H598.	6.9	7.5	50	85 x 175	1,10	1	A
CLZ-FP-69/10-HD	[C] R2H59B.	9.15	10	50	85 x 245	1,20	1	A
CLZ-FP-69/12,5-HD	[C] R2H59D.	11.4	12.5	50	85 x 245	1,40	1	A
CLZ-FP-69/15-HD	[C] R2H59E.	13.7	15	50	85 x 245	1,60	1	A
CLZ-FP-69/20-HD	[C] R2H59J.	18.3	20	50	100 x 245	2,40	7	A
CLZ-FP-69/25-HD	[C] R2H59L.	22.9	25	50	116 x 245	2,50	2	B
CLZ-FP-69/30-HD	[C] R2H59N.	27.5	30	50	136 x 220	3,80	-	B
CLZ-FP-69/40-HD	[C] R2H59R.	36.6	40	50	136 x 355	5,90	-	C
CLZ-FP-69/50-HD	[C] R2H59S.	45.75	50	50	136 x 355	5,90	-	C

All models are of the inert gas type, except for those with a 63.5 mm diameter and 136x355 mm size. The dimensions (dxh) are shown for the tube only. Please consult the dimensions drawing at the end of this section for more information about the actual dimensions. Terminal: maximum cross-section of type A cables: 16 mm², type B: 25 mm², type C: 35 mm², F: Faston 6.3x0.8 mm and 12 A maximum current

CLZ-FP24-60 HD, Three-phase tubular power capacitor, 60 Hz

Type	Code	230 V kvar	240 V kvar	Hz	dia.x alt. (mm)	weight (kg)	Cover (opc.)	Terminal
Un = 3 x 240 V / 60 Hz								
CLZ-FPT-24/2,5-60Hz-HD	[C] R2H622.	2.3	2.5	60	63,5 x 127	0,44	-	F
CLZ-FP-24/5-60Hz-HD	[C] R2H626.	4.6	5	60	85 x 175	1,00	1	A
CLZ-FP-24/6,25-60Hz-HD	[C] R2H627.	5.75	6.25	60	85 x 175	1,10	1	A
CLZ-FP-24/7,5-60Hz-HD	[C] R2H628.	6.9	7.5	60	85 x 245	1,10	1	A
CLZ-FP-24/10-60Hz-HD	[C] R2H62B.	9.2	10	60	85 x 245	1,10	1	A
CLZ-FP-24/12,5-60Hz-HD	[C] R2H62D.	11.5	12.5	60	85 x 245	1,60	1	A
CLZ-FP-24/15-60Hz-HD	[C] R2H62E.	13.8	15	60	100 x 245	2,10	7	A

Type	Code	400 V kvar	440 V kvar	Hz	dia.x alt. (mm)	weight (kg)	Cover (opc.)	Terminal
Un = 3 x 440 V / 60 Hz								
CLZ-FPT-44/1,25-60Hz-HD	[C] R2H641.	1	1.25	60	63,5 x 98	0,34	-	F
CLZ-FPT-44/2,5-60Hz-HD	[C] R2H642.	2.1	2.5	60	63,5 x 127	0,44	-	F
CLZ-FPT-44/3-60Hz-HD	[C] R2H643.	2.5	3	60	63,5 x 127	0,44	-	F
CLZ-FPT-44/3,75-60Hz-HD	[C] R2H644.	3.1	3.75	60	63,5 x 127	0,44	-	F
CLZ-FPT-44/5-60Hz-HD	[C] R2H646.	4.15	5	60	63,5 x 127	0,44	-	F
CLZ-FP-44/6,25-60Hz-HD	[C] R2H647.	5.2	6.25	60	85 x 175	0,80	1	A
CLZ-FP-44/7,5-60Hz-HD	[C] R2H648.	6.2	7.5	60	85 x 175	0,90	1	A
CLZ-FP-44/10-60Hz-HD	[C] R2H64B.	8.3	10	60	85 x 175	1,00	1	A
CLZ-FP-44/12,5-60Hz-HD	[C] R2H64D.	10.3	12.5	60	85 x 245	1,10	1	A
CLZ-FP-44/15-60Hz-HD	[C] R2H64E.	12.4	15	60	85 x 245	1,20	1	A
CLZ-FP-44/20-60Hz-HD	[C] R2H64J.	16.5	20	60	85 x 245	1,50	1	A
CLZ-FP-44/25-60Hz-HD	[C] R2H64L.	20.7	25	60	100 x 245	2,00	7	A
CLZ-FP-44/30-60Hz-HD	[C] R2H64N.	24.8	30	60	116 x 245	2,30	2	B
CLZ-FP-44/40-60Hz-HD	[C] R2H64R.	33.1	40	60	136 x 220	2,80	2	B
CLZ-FP-44/50-60Hz-HD	[C] R2H64S.	41.3	50	60	136 x 355	5,60	-	C

Type	Code	460 V kvar	480 V kvar	Hz	dia.x alt. (mm)	weight (kg)	Cover (opc.)	Terminal
Un = 3 x 480 V / 60 Hz								
CLZ-FPT-48/2,5-60Hz-HD	[C] R2H762.	2.3	2.5	60	63,5 x 127	0,80	-	F
CLZ-FPT-48/5-60Hz-HD	[C] R2H766.	4.6	5	60	63,5 x 175	0,80	-	F
CLZ-FPT-48/6,25-60Hz-HD	[C] R2H767.	5.75	6.25	60	63,5 x 175	0,90	-	F
CLZ-FPT-48/7,5-60Hz-HD	[C] R2H768.	6.9	7.5	60	63,5 x 175	0,90	-	F
CLZ-FP-48/10-60Hz-HD	[C] R2H66B.	9.2	10	60	85 x 175	1,10	1	A
CLZ-FP-48/12,5-60Hz-HD	[C] R2H66D.	11.5	12.5	60	85 x 245	1,20	1	A
CLZ-FP-48/15-60Hz-HD	[C] R2H66E.	13.8	15	60	85 x 245	1,30	1	A
CLZ-FP-48/20-60Hz-HD	[C] R2H66J.	18.4	20	60	100 x 245	1,90	7	A
CLZ-FP-48/25-60Hz-HD	[C] R2H66L.	23	25	60	100 x 245	2,20	2	B
CLZ-FP-48/30-60Hz-HD	[C] R2H66N.	27.6	30	60	116 x 245	2,40	2	B
CLZ-FP-48/40-60Hz-HD	[C] R2H66R.	36.75	40	60	136 x 220	3,80	-	B
CLZ-FP-48/50-60Hz-HD	[C] R2H66S.	46	50	60	136 x 355	5,90	-	C

Type	Code	480 V kvar	525 V kvar	Hz	dia.x alt. (mm)	weight (kg)	Cover (opc.)	Terminal
CLZ-FP-52/7,5-60Hz-HD	[C] R2H678.	-	-	-	-	-	-	-
Un = 3 x 525 V / 60 Hz								
CLZ-FPT-52/2,5-60Hz-HD	[C] R2H772.	2.1	2.5	60	63,5 x 127	0,80	-	F
CLZ-FPT-52/5-60Hz-HD	[C] R2H776.	4.2	5	60	63,5 x 175	0,90	-	F
CLZ-FPT-52/6,25-60Hz-HD	[C] R2H777.	5.2	6.25	60	63,5 x 175	1,10	-	F
CLZ-FPT-52/7,5-60Hz-HD	[C] R2H778.	6.25	7.5	60	63,5 x 202	1,30	-	F
CLZ-FP-52/8,5-60Hz-HD	[C] R2H67A.	7.1	8.5	60	85 x 175	1,00	1	A
CLZ-FP-52/10-60Hz-HD	[C] R2H67B.	8.4	10	60	85 x 175	1,10	1	A
CLZ-FP-52/11,5-60Hz-HD	[C] R2H67C.	9.6	11.5	60	85 x 245	1,20	1	A
CLZ-FP-52/12,5-60Hz-HD	[C] R2H67D.	10.5	12.5	60	85 x 245	1,20	1	A
CLZ-FP-52/15-60Hz-HD	[C] R2H67E.	12.5	15	60	85 x 245	1,40	1	A
CLZ-FP-52/17-60Hz-HD	[C] R2H67I.	14.2	17	60	85 x 245	1,50	1	A
CLZ-FP-52/20-60Hz-HD	[C] R2H67J.	16.7	20	60	100 x 245	2,00	7	A
CLZ-FP-52/22,5-60Hz-HD	[C] R2H67K.	18.8	22.5	60	100 x 245	2,20	7	A
CLZ-FP-52/25-60Hz-HD	[C] R2H67L.	20.9	25	60	100 x 245	2,40	7	A
CLZ-FP-52/30-60Hz-HD	[C] R2H67N.	25	30	60	116 x 245	2,50	2	B
CLZ-FP-52/34-60Hz-HD	[C] R2H67P.	28.4	34	60	116 x 245	2,60	2	B
CLZ-FP-52/40-60Hz-HD	[C] R2H67R.	33.4	40	60	136 x 261	3,80	-	B

CLZ-FP60-60 HD, Three-phase tubular power capacitor, 60 Hz

Type	Code	Hz	dia.x alt. (mm)	weight (kg)	Cover (opc.)	Terminal
Un = 3 x 600 V / 60 Hz						
CLZ-FP-60/2,5-60Hz-HD	[C] R2H782.	60	63,5 x 127	0,70	-	F
CLZ-FPT-60/5-60Hz-HD	[C] R2H786.	60	63,5 x 175	0,80	-	F
CLZ-FPT-60/6,25-60Hz-HD	[C] R2H787.	60	63,5 x 175	0,90	-	F
CLZ-FPT-60/7,5-60Hz-HD	[C] R2H788.	60	63,5 x 175	1,00	-	F
CLZ-FP-60/10-60Hz-HD	[C] R2H68A.	60	85 x 175	1,10	1	A
CLZ-FP-60/12,5-60Hz-HD	[C] R2H68B.	60	85 x 245	1,20	1	A
CLZ-FP-60/15-60Hz-HD	[C] R2H68E.	60	85 x 245	1,30	1	A
CLZ-FP-60/17,5-60Hz-HD	[C] R2H68I.	60	85 x 245	1,40	1	A
CLZ-FP-60/20-60Hz-HD	[C] R2H68J.	60	100 x 245	1,90	7	A
CLZ-FP-60/21-60Hz-HD	[C] R2H68K.	60	100 x 245	2,00	7	A
CLZ-FP-60/25-60Hz-HD	[C] R2H68L.	60	100 x 245	2,20	7	A
CLZ-FP-60/30-60Hz-HD	[C] R2H68N.	60	116 x 245	2,40	2	B
CLZ-FP-60/34,5-60Hz-HD	[C] R2H68P.	60	116 x 245	2,60	2	B

Type	Code	660 V kvar	690 V kvar	Hz	dia.x alt. (mm)	weight (kg)	Cover (opc.)	Terminal
Un = 3 x 690 V / 60 Hz								
CLZ-FPT-69/2,5-60Hz-HD	[C] R2H792.	2.3	2.5	60	63,5 x 127	0,90	-	F
CLZ-FPT-69/5-60Hz-HD	[C] R2H796.	4.6	5	60	63,5 x 175	1,00	-	F
CLZ-FPT-69/7,5-60Hz-HD	[C] R2H798.	6.9	7.5	60	63,5 x 202	1,10	-	F
CLZ-FP-69/10-60Hz-HD	[C] R2H69B.	9.15	10	60	85 x 245	1,10	1	A
CLZ-FP-69/12,5-60Hz-HD	[C] R2H69D.	11.4	12.5	60	85 x 245	1,20	1	A
CLZ-FP-69/15-60Hz-HD	[C] R2H69E.	13.7	15	60	85 x 245	1,40	1	A
CLZ-FP-69/20-60Hz-HD	[C] R2H69J.	18.3	20	60	100 x 245	2,00	7	A
CLZ-FP-69/25-60Hz-HD	[C] R2H69L.	22.9	25	60	116 x 245	2,30	2	B
CLZ-FP-69/30-60Hz-HD	[C] R2H69N.	27.5	30	60	116 x 245	2,50	2	B
CLZ-FP-69/40-60Hz-HD	[C] R2H69R.	36.6	40	60	136 x 220	3,80	-	B
CLZ-FP-69/50-60Hz-HD	[C] R2H69S.	45.75	50	60	136 x 355	5,90	-	C

CMC, Contactors with fast discharge resistor

Type	Code	220 V kvar	240 V kvar	480 V kvar	660 V kvar	690 V kvar	kvar 200-240V	kvar 400-440-480 V	kvar 500-550V	kvar 660-690 V	Hz	Coil voltage (Vac)
CMC 7.5 B	[C] R281A5.	5	5	7.5	11	11	5	7.5	9	11	50/60	230
CMC 12 B	[C] R281A6.	6.7	6.7	12.5	18	18	6.7	12.5	15	18	50/60	230
CMC 20 B	[C] R281A4.	11	11	20	30	30	11	20	24	30	50/60	230
CMC 32 B	[C] R281A8.	14	14	25	35	35	14	25	30	35	50/60	230
CMC 40 B	[C] R281A1.	20	20	30	40	40	20	30	35	40	50/60	230
CMC 75 B	[C] R281A9.	29	29	50	70	70	29	50	60	70	50/60	230
CMC 85 B	[C] R281A3.	32	32	60	80	80	32	60	70	80	50/60	230
CMC 150 B	[C] R281AD.	45	45	80	115	115	45	80	100	115	50/60	230

RD,,Fast discharging resistors

Type	Code	Impedance (Ω)	Dissipated power (w)
RD-25 2X1500	[1] R3Z210.	2 x 1500	10
RD-60 2X1000	[*] R3Z220.	2 x 1000	10
RD-100 2X1000	[*] R3Z230.	2 x 1000	15

IR, current limiting impedances

Type	Code	Cable section (mm2)
IR-6	[*] R3Z310.	6
IR-10	[*] R3Z320.	10
IR-25	[*] R3Z330.	25
IR-35	[*] R3Z340.	35
IR-50	[*] R3Z350.	50

ELEB, CSB coils

Type	Code	Use voltage (V)	μF
ELEB10100PCA	[1] R213A8.	230	100
ELEB10150PCA	[1] R213AE.	230	150
ELEB14055PCA	[1] R2139D.	400/440/690(*)	55
ELEB14069PCA	[1] R2139H.	400/440/690(*)	69
ELEB14082PCA	[1] R2139R.	400/440/690(*)	82
Type	Code	Use voltage (V)	μF
ELEB18027PCA	[1] R2137T.	460	27.4
ELEB18035PCA	[1] R2137A.	460	35
ELEB18050PCA	[1] R2137P.	460	50
ELEB20019PCA	[1] R2138D.	480/525/550	19.2
ELEB20038PCA	[1] R2138G.	480/525/550	38.4

CSB, Power capacitors for LV

Type	Code	kvar 50 Hz	kvar 60 Hz	Size (mm) width xhei- ght xdepth	weight (kg)
230 Vac					
CSB-23/10	[*] R2321C.	10	12.5	359x330x120	3,30
CSB-23/12,5	[2] R2321D.	12.5	15	360x330x120	3,30
CSB-23/15	[*] R2321E.	15	17.5	360x330x120	3,30
CSB-23/20	[*] R2321F.	20	25	360x330x120	4,20
CSB-23/25	[2] R2321G.	25	30	360x330x120	5,00
CSB-23/30	[2] R2321H.	30	35	360x330x120	5,00
CSB-23/40	[*] R2321J.	40	50	360x520x120	7,30
CSB-23/50	[*] R2321K.	50	60	360x520x120	8,20
400 Vac					
CSB-40/15	[*] R2323E.	15	17.5	360x330x120	3,30
CSB-40/20	[*] R2323F.	20	25	360x330x120	3,30
CSB-40/25	[*] R2323G.	25	30	360x330x120	3,30
CSB-40/30	[*] R2323H.	30	35	360x330x120	4,20
CSB-40/40	[*] R2323J.	40	50	360x330x120	5,00
CSB-40/50	[*] R2323K.	50	60	360x330x120	5,00
CSB-40/60	[*] R2323L.	60	70	360x520x120	6,60
CSB-40/80	[*] R2323Q.	80	95	360x520x120	8,20
CSB-40/100	[*] R2323R.	100	120	360x520x120	9,00
440 Vac					
CSB-44/15	[*] R2324E.	15	17.5	360x330x120	2,60
CSB-44/20	[*] R2324F.	20	25	360x330x120	3,30
CSB-44/25	[2] R2324G.	25	30	360x330x120	3,30
CSB-44/30	[*] R2324H.	30	35	360x330x120	3,50
CSB-44/40	[*] R2324J.	40	50	360x330x120	4,20
CSB-44/50	[*] R2324K.	50	60	360x330x120	5,00
CSB-44/60	[*] R2324L.	60	70	360x330x120	5,00
CSB-44/80	[*] R2324Q.	80	95	360x520x120	7,30
CSB-44/100	[*] R2324R.	100	120	360x520x120	8,20
460 Vac					
CSB-46/15	[2] R2325E.	15	17.5	360x330x120	3,30
CSB-46/20	[*] R2325F.	20	25	360x330x120	3,30
CSB-46/25	[2] R2325G.	25	30	360x330x120	4,20
CSB-46/30	[*] R2325H.	30	35	360x330x120	4,20
CSB-46/40	[*] R2325J.	40	50	360x330x120	5,00
CSB-46/50	[*] R2325K.	50	60	360x520x120	6,60
CSB-46/60	[*] R2325L.	60	70	360x520x120	7,30
CSB-46/80	[*] R2325Q.	80	95	360x520x120	9,00
CSB-46/100	[*] R2325R.	100	120	360x610x120	10,90

CSB-2V, Power capacitors for LV dual voltage

Type	Code	kvar 50 Hz	kvar 60 Hz	Size (mm) width xhei- ght xdepth	weight (kg)
230 / 400 Vac					
CSB-2340/5	[2] R23288.	5	6	360x330x120	3,30
CSB-2340/7,5	[2] R2328A.	7.5	9	360x330x120	3,90
CSB-2340/10	[2] R2328C.	10	12.5	360x330x120	3,90
CSB-2340/12,5	[2] R2328D.	12.5	15	360x330x120	3,90
CSB-2340/15	[2] R2328E.	15	17.5	360x330x120	4,60
CSB-2340/20	[2] R2328F.	20	25	360x330x120	4,60
CSB-2340/25	[2] R2328G.	25	30	360x330x120	4,60
CSB-2340/30	[2] R2328H.	30	35	360x330x120	6,20
CSB-2340/40	[2] R2328J.	40	50	360x520x120	8,30

Type	Code	kvar 50 Hz	kvar 60 Hz	Size (mm) width xhei- ght xdepth	weight (kg)
480 Vac					
CSB-48/10	[C] R277AC.	8	10	360x330x120	2,80
CSB-48/15	[C] R277AE.	12.5	15	360x330x120	3,50
CSB-48/20	[C] R277AF.	16.7	20	360x330x120	3,50
CSB-48/25	[C] R277AG.	20.8	25	360x330x120	4,20
CSB-48/30	[C] R277AH.	25	30	360x330x120	4,20
CSB-48/40	[C] R277AJ.	33.3	40	360x330x120	5,00
CSB-48/50	[C] R277AK.	41.7	50	360x520x120	6,80
CSB-48/60	[C] R277AL.	50	60	360x520x120	7,50
525 Vac					
CSB-52/10	[C] R2326C.	10	12.5	360x330x120	2,60
CSB-52/15	[C] R2326E.	15	17.5	360x330x120	3,30
CSB-52/20	[C] R2326F.	20	25	360x330x120	3,30
CSB-52/25	[C] R2326G.	25	30	360x330x120	4,20
CSB-52/30	[C] R2326H.	30	35	360x330x120	4,20
CSB-52/40	[C] R2326J.	40	50	360x330x120	5,00
CSB-52/50	[C] R2326K.	50	60	360x520x120	6,60
CSB-52/60	[C] R2326L.	60	70	360x520x120	7,30
CSB-52/70	[C] R2326M.	70	85	360x520x120	8,20
690 Vac					
CSB-69/10	[3] R232BC.	10	12.5	360x330x120	2,60
CSB-69/15	[3] R232BE.	15	17.5	360x330x120	3,30
CSB-69/20	[3] R232BF.	20	25	360x330x120	3,30
CSB-69/25	[3] R232BG.	25	30	360x330x120	3,30
CSB-69/30	[3] R232BH.	30	35	360x330x120	4,20
CSB-69/40	[3] R232BJ.	40	50	360x330x120	5,00
CSB-69/50	[3] R232BK.	50	60	360x330x120	5,00
CSB-69/60	[3] R232BL.	60	70	360x520x120	6,60
CSB-69/80	[3] R232BQ.	80	95	360x520x120	8,20
CSB-69/100	[3] R232BR.	100	0	360x520x120	9,00
1100 Vac for LV networks					
CSB-110/10	[1] R2327C.	10	12	360x330x120	3,50
CSB-110/20	[1] R2327F.	20	24	360x330x120	5,00
CSB-110/30	[1] R2327H.	30	36	360x330x120	5,00
CSB-110/40	[1] R2327J.	40	48	360x520x120	7,50
CSB-110/50	[1] R2327K.	50	60	360x520x120	9,00
CSB-110/60	[1] R2327L.	60	72	360x520x120	9,00
CSB-110/70	[1] R2327M.	70	84	360x610x120	10,90

Dual voltage capacitors are used for fixed compensation purposes in motors



CFB, Power capacitors for harmonic filtering (for FR)

Type	Code	230 V kvar		For reactor	Size (mm) width xheight xdepth	weight (kg)
CFB 260						
CFB-26/6,3	[1] R2412A.	5		RX-5-230	360x330x120	2,60
CFB-26/12,5	[1] R2412D.	10		RX-10-230	360x330x120	3,30
CFB-26/18	[1] R2412E.	15		RBX-15-230	360x330x120	3,30
CFB-26/25	[1] R2412G.	20		RBX-20-230	360x330x120	4,20
CFB-26/30	[1] R2412H.	25		RBX-25-230	360x330x120	5,00
CFB-26/37	[1] R2412J.	30		RBX-30-230	360x330x120	5,00
CFB-26/48	[1] R2412K.	40		RBX-40-230	360x520x120	7,30
CFB-26/60	[1] R2412L.	50		RBX-50-230	360x520x120	8,20

Type	Code	400 V kvar	440 V kvar	For reactor	Size (mm) width xheight xdepth	weight (kg)
CFB 460						
CFB-46/6	[1] R2415A.	5	6.25	RX-6,25-460	360x330x120	3,30
CFB-46/12,5	[1] R2415D.	10	12.5	RX-10-400 / 12,5-460	360x330x120	3,90
CFB-46/15	[1] R2415E.	12.5	15	RX-12,5-400 / 15-460	360x330x120	3,90
CFB-46/19	[1] R2415F.	15	18.5	RX-15-400 / 19-460	360x330x120	3,90
CFB-46/25	[1] R2415G.	20	25	RBX-20-400 / 25-460	360x330x120	4,60
CFB-46/30	[1] R2415H.	25	30	RBX-25-400 / 30-460	360x330x120	4,60
CFB-46/37	[1] R2415J.	30	40	RBX-30-400 / 37-460	360x330x120	6,20
CFB-46/50	[*] R2415K.	40	50	RBX-40-400 / 50-460	360x520x120	7,00
CFB-46/62	[*] R2415L.	50	60	RBX-50-400 / 62-460	360x520x120	9,20
CFB-46/74	[*] R2415P.	60	75	RBX-60-400 / 74-460	360x520x120	9,90
CFB-46/100	[*] R2415R.	80	100	RBX-80-400 / 100-460	360x610x120	11,30

Type	Code	690 V kvar		For reactor	Size (mm) width xheight xdepth	weight (kg)
CFB 790						
CFB-79/6	[C] R241DA.	5		RE-5-400 / 6-460	360x330x120	2,60
CFB-79/12,5	[C] R241DD.	10		RE-10-400 / 12,5-460	360x330x120	2,60
CFB-79/19	[C] R241DF.	15		RE-15-400 / 19-460	360x330x120	3,30
CFB-79/25	[C] R241DG.	20		RE-20-400 / 25-460	360x330x120	3,30
CFB-79/30	[C] R241DH.	25		RE-25-400 / 30-460	360x330x120	4,20
CFB-79/37	[C] R241DI.	30		RE-30-400 / 37-460	360x330x120	4,20
CFB-79/50	[C] R241DK.	40		RE-40-400 / 50-460	360x520x120	5,00
CFB-79/62	[C] R241DL.	50		RBE-50-400 / 62-460	360x520x120	6,60
CFB-79/74	[C] R241DP.	60		RBE-60-400 / 74-460	360x520x120	7,30
CFB-79/100	[C] R241DR.	80		RBE-80-400 / 100-460	360x610x120	9,00

Supplement selection table to adapt CSB / CFB capacitor height to a capacitor bank equipped with CS / CF capacitors

CS / CF Capacitor TO REPLACE		CSB / CFB NEW capacitor			
Total capacitor height (box + terminals) (mm)	Height box capacitor (mm)	Total height of capacitor (box+terminals) (mm)	Capacitor box height (mm)		
390	330	330	270	SP-60	[*] R2ZZZ1
610	550	520	460	SP-90	[*] R2ZZZ2
760	700	610	550	SP-150	[*] R2ZZZ3

Delivery time: [*] immediate
[x] working weeks
[c] consult

RX / RBX, Reactors III for detuned static filters

Type	Code	400 V kvar	440 V kvar	Hz	For capacitor	In (A)	L(mH)	Losses	Size (mm) width xheight xdepth	weight (kg)
400 Vac, 50 Hz, f resonance = 189 Hz / p= 7%										
RX-5-400	[*] P72110.	5	-	50	CLZ-FP-46/6,25 - CFB-46/6	7,6	7.66	25	155x165x92	5,00
RX-6,25-400	[*] P72112.	6.25	-	50	CLZ-FP-52/10 - CFB-46/7,75	10	6.12	36	180x190x100	8,00
RX-10-400	[*] P72115.	10	-	50	CLZ-FP-46/12,5 - CFB-46/12,5	15,5	3.83	50	180x190x100	7,50
RX-12,5-400	[*] P72117.	12.5	-	50	CLZ-FP-46/15 - CFB-46/15	19	3.06	53	180x192x110	8,00
RX-15-400	[*] P72120.	15	-	50	CLZ-FP-46/19 - CFB-46/19	23	2.55	57	180x190x110	8,50
RBX-20-400	[*] P72125.	20	-	50	CLZ-FP-46/25 - CFB-46/25	30	1.92	69	235x165x125	14,00
RBX-25-400	[*] P72130.	25	-	50	CLZ-FP-46/30 - CFB-46/30	37	1.53	106	235x165x125	14,00
RBX-30-400	[*] P72135.	30	-	50	2 x CLZ-FP-46/19 - CFB-46/37	45	1.27	102	255x200x125	19,00
RBX-40-400	[*] P72140.	40	-	50	2 x CLZ-FP-46/25 - CFB-46/50	60	0.95	137	255x200x125	20,00
RBX-50-400	[*] P72145.	50	-	50	2 x CLZ-FP-46/30 - CFB-46/62	75	0.76	153	255x220x145	25,00
RBX-60-400	[*] P72150.	60	-	50	3 x CLZ-FP-46/25 - CFB-46/74	90	0.63	168	280x240x145	28,00
RBX-80-400	[*] P72155.	80	-	50	4 x CLZ-FP-46/25 - CFB-46/100	120	0.47	246	305x235x155	31,00
400 Vac, 50 Hz, f resonance = 134 Hz / p= 14%										
RX-5-400-14%	[C] P71021.	5	-	50	CLZ-FP-52/7,5-HD - CFB-52/7,5	-	16.31	-	-	-
RX-10-400-14%	[C] P71022.	10	-	50	CLZ-FP-52/15-HD - CFB-52/15	-	8.15	-	-	-
RX-12,5-400-14%	[C] P71023.	12.5	-	50	CLZ-FP-52/20-HD - CFB-52/19	-	6.52	-	-	-
RX-15-400-14%	[C] P71024.	15	-	50	CLZ-FP-52/25-HD - CFB-52/23	-	5.43	-	-	-
RX-20-400-14%	[C] P71025.	20	-	50	CLZ-FP-52/30-HD - CFB-52/30	-	4.07	-	-	-
RBX-25-400-14%	[C] P72330.	25	-	50	CLZ-FP-52/12,5-HD + CLZ-FP-52/30-HD - CFB-52/38	-	3.26	-	-	-
RBX-30-400-14%	[C] P72335.	30	-	50	CLZ-FP-52/25-HD + CLZ-FP-52/20-HD - CFB-52/46	-	2.71	-	-	-
RBX-40-400-14%	[C] P72340.	40	-	50	2 x CLZ-FP-52/30-HD - CFB-52/60,5	-	2.03	-	-	-
RBX-50-400-14%	[C] P72345.	50	-	50	3 x CLZ-FP-52/25-HD - CFB-52/76	-	1.63	-	-	-
RBX-60-400-14%	[C] P72350.	60	-	50	3 x CLZ-FP-52/30-HD - CFB-52/91	-	1.35	-	-	-
400 Vac, 50 Hz, f resonance = 210 Hz / p= 5,67%										
RX-5-400-5,67%	[C] P72210.	-	5	50	CLZ-FP-46/6,25-HD - CFB-46/6	-	6.11	-	-	-
RX-6,25-400-5,67%	[C] P72212.	-	6.25	50	CLZ-FP-52/10-HD - CFB-46/7,75	-	4.88	-	-	-
RX-10-400-5,67%	[C] P72215.	-	10	50	CLZ-FP-46/12,5-HD - CFB-46/12,5	-	3.05	-	-	-
RX-12,5-400-5,67%	[C] P72217.	-	12.5	50	CLZ-FP-46/15-HD - CFB-46/15	-	2.44	-	-	-
RX-15-400-5,67%	[C] P72220.	-	15	50	CLZ-FP-46/19-HD - CFB-46/19	-	2.04	-	-	-
RBX-20-400-5,67%	[C] P72225.	-	20	50	CLZ-FP-46/25-HD - CFB-46/25	-	1.53	-	-	-
RBX-25-400-5,67%	[C] P72230.	-	25	50	CLZ-FP-46/30-HD - CFB-46/30	-	1.22	-	-	-
RBX-30-400-5,67%	[C] P72235.	-	30	50	2 x CLZ-FP-46/19-HD - CFB-46/37	-	1.02	-	-	-
RBX-40-400-5,67%	[C] P72240.	-	40	50	2 x CLZ-FP-46/25-HD - CFB-46/50	-	0.76	-	-	-
RBX-50-400-5,67%	[C] P72245.	-	50	50	2 x CLZ-FP-46/30-HD - CFB-46/62	-	0.61	-	-	-
RBX-60-400-5,67%	[C] P72250.	-	60	50	3 x CLZ-FP-46/25-HD - CFB-46/74	-	0.51	-	-	-
RBX-80-400-5,67%	[C] P72255.	-	80	50	4 x CLZ-FP-46/25-HD - CFB-46/100	-	0.38	-	-	-

RX / RBX-60Hz, Reactors III for detuned static filters

Type	Code	480 V kvar	Hz	For capacitor	L(mH)
480 Vac, 60 Hz, f resonance = 227 Hz / p= 7%					
RX-7,5-480-60 Hz-7%	[C] P721130017000	7.5	60	CLZ-FP-52/8,5-60Hz-HD -	6.12
RX-10-480-60Hz-7%	[C] P721150017000	10	60	CLZ-FP-52/11,5-60Hz-HD -	4.58
RX-12,5-480-60 Hz-7%	[C] P721170017000	12.5	60	CLZ-FP-52/15-60Hz-HD -	3.66
RX-15-480-60 Hz-7%	[C] P721200017000	15	60	CLZ-FP-52/17-60Hz-HD -	3.06
RBX-20-480-60Hz-7%	[C] P721250017000	20	60	CLZ-FP-52/22,5-60Hz-HD -	2.29
RBX-25-480-60 Hz-7%	[C] P721300017000	25	60	CLZ-FP-52/30-60Hz-HD -	1.83
RBX-30-480-60 Hz-7%	[C] P721350017000	30	60	CLZ-FP-52/34-60Hz-HD -	1.53
RBX-40-480-60Hz-7%	[C] P721400017000	40	60	2 x CLZ-FP-52/22,5-60Hz-HD -	1.15
RBX-50-480-60 Hz-7%	[C] P721450017000	50	60	2 x CLZ-FP-52/30 -60Hz-HD -	0.92
RBX-60-480-60 Hz-7%	[C] P721500017000	60	60	2 x CLZ-FP-52/34-60Hz-HD -	0.76
RBX-80-480-60Hz-7%	[C] P721550017000	80	60	3 x CLZ-FP-52/30-60Hz-HD -	0.58
480 Vac, 60 Hz, f resonance = 160 Hz / p= 14%					
RX-12,5-480-60Hz-14%	[C] P710230017000	12.5	60	CLZ-FP-60/17,5-60Hz-HD -	7.81
RX-15-480-60Hz-14%	[C] P710240017000	15	60	CLZ-FP-60/21-60Hz-HD -	6.52
RX-25-480-60Hz-14%	[C] P723300017000	25	60	CLZ-FP-60/34,5-60Hz-HD -	3.91
RBX-30-480-60Hz-14%	[C] P723500017000	30	60	2 x CLZ-FP-60/21-60Hz-HD -	3.26
RBX-50-480-60Hz-14%	[C] P724200017000	50	60	2 x CLZ-FP-60/34,5-60Hz-HD -	1.95

 Delivery time: [*] immediate
 [x] working weeks
 [c] consult



CFB-6B, Power capacitors for harmonics filters with static switching operation of the FRE series

Type	Code	400 V kvar	440 V kvar	For reactor	Size (mm) width xheight xdepth	weight (kg)
CFB-46/6-6B	[C] R2425A.	5	6.25	RE-5-400 / 6-460	360x330x120	3,30
CFB-46/12,5-6B	[C] R2425D.	10	12.5	RE-10-400 / 12,5-460	360x330x120	3,90
CFB-46/19-6B	[C] R2425F.	15	18.5	RE-15-400 / 19-460	360x330x120	3,90
CFB-46/25-6B	[C] R2425G.	20	25	RE-20-400 / 25-460	360x330x120	4,60
CFB-46/30-6B	[C] R2425H.	25	30	RE-25-400 / 30-460	360x330x120	4,60
CFB-46/37-6B	[C] R2425J.	30	40	RE-30-400 / 37-460	360x330x120	6,20
CFB-46/50-6B	[C] R2425K.	40	50	RE-40-400 / 50-460	360x520x120	7,00
CFB-46/62-6B	[C] R2425L.	50	60	RBE-50-400 / 62-460	360x520x120	9,20
CFB-46/74-6B	[C] R2425P.	60	75	RBE-60-400 / 74-460	360x520x120	9,90
CFB-46/100-6B	[C] R2425R.	80	100	RBE-80-400 / 100-460	360x610x120	11,30

NOTE: The capacitor has been sized for 460/260 V and a power that is 25% higher than that indicated in all columns to compensate for the overvoltage effect of the reactor.

Type	Code	230 V kvar	For reactor	Size (mm) width xheight xdepth	weight (kg)
CFB-26/6,3-6B	[C] R2422A.	5	RE-5-230	360x330x120	3,20
CFB-26/12,5-6B	[C] R2422D.	10	RE-10-230	360x330x120	3,90
CFB-26/18-6B	[C] R2422E.	15	RE-15-230	360x330x120	4,60
CFB-26/25-6B	[C] R2422G.	20	RBE-20-230	360x330x120	6,20
CFB-26/30-6B	[C] R2422H.	25	RBE-22-230	360x330x120	7,00
CFB-26/37-6B	[C] R2422J.	30	RBE-30-230	360x330x120	6,20
CFB-26/48-6B	[C] R2422K.	40	RBE-40-230	360x520x120	8,30

RE-RBE, Reactors III for detuned static filters with FRE static switching

For capacitors with 6 terminals



Type	Code	400 V kvar	Hz	For capacitor	In (A)	L(mH)	Losses	Size (mm) width xheight xdepth	weight (kg)
RE-5-400	[4] P70210.	5	50	CFB 46 / 6-6B	5 A	23.67	25	92x165x155	6,00
RE-10-400	[4] P70215.	10	50	CFB 46 / 12,5-6B	9 A	11.27	50	102x190x180	8,00
RE-15-400	[4] P70220.	15	50	CFB 46 / 19-6B	13 A	7.5	57	112x190x180	9,50
RE-20-400	[4] P70225.	20	50	CFB 46 / 25-6B	17 A	5.68	76	122x190x180	11,50
RE-25-400	[4] P70230.	25	50	CFB 46 / 30-6B	21 A	4.68	90	122x250x240	17,00
RE-30-400	[4] P70235.	30	50	CFB 46 / 37-6B	26 A	3.84	120	132x250x240	20,50
RE-40-400	[4] P70240.	40	50	CFB 46 / 50-6B	35 A	2.84	145	147x250x240	25,50
RBE-50-400	[4] P70245.	50	50	CFB 46 / 62-6B	42 A	2.29	185	154x233x310	29,00
RBE-60-400	[4] P70250.	60	50	CFB 46 / 74-6B	51 A	1.89	205	154x234x338	30,00
RBE-80-400	[4] P70255.	80	50	CFB 46 / 100-6B	68 A	1.42	235	154x254x338	41,00

CODIFICATION TABLE

RX, RBX, RE, RBE

Code	Internal code					
P	7	X	X	X	X	0 0 X X X
						↑ ↑ ↑
						Delivery time
Frequency	Standard (50 Hz)				0	-
	60 Hz				1	C
Voltage	Standard (400 V _{c.a.})				0	-
	230 V _{c.a.}				1	C
	Other voltages				C	C
factor P %	Standard (7 %)				0	-
	6 %				1	C
	12,5 %				2	C
	14 %				3	C

Delivery time: [*] immediate
[x] working weeks
[c] consult

CV, Power capacitors for LV

Type	Code	kvar 50 Hz	kvar 60 Hz	Size (mm) width x height x depth	weight (kg)
230 Vac					
CV-23/2,5	[*] R20114.	2.5	3	204x435x75	3,00
CV-23/3,75	[*] R20116.	3.75	4.5	204x435x75	3,50
CV-23/5	[*] R20118.	5	6	204x435x75	3,50
CV-23/7,5	[*] R2011A.	7.5	9	204x435x75	4,00
CV-23/10	[*] R2011C.	10	12.5	204x435x75	4,00
CV-23/12,5	[*] R2011D.	12.5	15	204x435x75	4,50
CV-23/15	[*] R2011E.	15	17.5	204x435x75	4,50
400 Vac					
CV-40/2,5	[*] R20134.	2.5	3	204x435x75	2,50
CV-40/5	[*] R20138.	5	4.5	204x435x75	2,50
CV-40/7,5	[*] R2013A.	7.5	9	204x435x75	3,00
CV-40/10	[*] R2013C.	10	12.5	204x435x75	3,00
CV-40/12,5	[*] R2013D.	12.5	15	204x435x75	3,50
CV-40/15	[*] R2013E.	15	17.5	204x435x75	4,50
CV-40/20	[*] R2013F.	20	25	204x435x75	4,50
CV-40/25	[*] R2013G.	25	30	204x435x75	6,50

Type	Code	kvar 50 Hz	kvar 60 Hz	Size (mm) width x height x depth	weight (kg)
440 Vac					
CV-44/2,5	[*] R20144.	2.5	3	204x435x75	2,00
CV-44/5	[*] R20148.	5	4.5	204x435x75	2,00
CV-44/7,5	[*] R2014A.	7.5	9	204x435x75	2,50
CV-44/10	[*] R2014C.	10	12.5	204x435x75	2,50
CV-44/12,5	[*] R2014D.	12.5	15	204x435x75	3,00
CV-44/15	[*] R2014E.	15	17.5	204x435x75	4,00
CV-44/20	[*] R2014F.	20	25	204x435x75	4,00
CV-44/25	[*] R2014G.	25	30	204x435x75	6,00
CV-44/30	[*] R2014J.	30	35	204x435x75	6,50
460 Vac					
CV-46/2,5	[1] R20154.	2.5	3	204x435x75	1,00
CV-46/5	[1] R20158.	5	6	204x435x75	1,00
CV-46/7,5	[1] R2015A.	7.5	9	204x435x75	1,50
CV-46/10	[1] R2015C.	10	12.5	204x435x75	1,50
CV-46/12,5	[1] R2015D.	12.5	15	204x435x75	2,00
CV-46/15	[*] R2015E.	15	17.5	204x435x75	3,00

CQ, Power capacitors for LV

Type	Code	kvar 50 Hz	kvar 60 Hz	Size (mm) width x height x depth	weight (kg)
230 Vac					
CQ-23/10	[*] R2031C.	10	12.5	360x520x75	4,90
CQ-23/12,5	[*] R2031D.	12.5	15	360x520x75	4,90
CQ-23/15	[*] R2031E.	15	17.5	360x520x75	4,90
CQ-23/20	[*] R2031F.	20	25	360x520x75	6,40
CQ-23/25	[*] R2031G.	25	30	360x520x75	7,90
CQ-23/30	[*] R2031H.	30	35	360x520x75	7,90
400 Vac					
CQ-40/10	[*] R2033C.	10	12.5	360x520x75	4,00
CQ-40/12,5	[*] R2033D.	12.5	15	360x520x75	4,50
CQ-40/15	[*] R2033E.	15	17.5	360x520x75	5,00
CQ-40/20	[*] R2033F.	20	25	360x520x75	6,00
CQ-40/25	[*] R2033G.	25	30	360x520x75	6,00
CQ-40/30	[*] R2033H.	30	35	360x520x75	6,00
CQ-40/40	[*] R2033J.	40	50	360x520x75	7,00
CQ-40/50	[*] R2033K.	50	60	360x520x75	9,00

Type	Code	kvar 50 Hz	kvar 60 Hz	Size (mm) width x height x depth	weight (kg)
440 Vac					
CQ-44/15	[*] R2034E.	15	17.5	360x520x75	4,10
CQ-44/20	[*] R2034F.	20	25	360x520x75	4,90
CQ-44/25	[*] R2034G.	25	30	360x520x75	4,90
CQ-44/30	[*] R2034H.	30	35	360x520x75	4,90
CQ-44/40	[*] R2034J.	40	50	360x520x75	6,00
CQ-44/50	[*] R2034K.	50	60	360x520x75	7,90
460 Vac					
CQ-46/10	[C] R2035C.	10	12.5	360x520x75	4,10
CQ-46/12,5	[C] R2035D.	12.5	15	360x520x75	4,10
CQ-46/15	[C] R2035E.	15	17.5	360x520x75	4,10
CQ-46/20	[C] R2035F.	20	25	360x520x75	4,90
CQ-46/25	[C] R2035G.	25	30	360x520x75	4,90
CQ-46/30	[C] R2035H.	30	35	360x520x75	4,90
CQ-46/40	[C] R2035J.	40	50	360x520x75	7,90
CQ-46/50	[C] R2035K.	50	60	360x520x75	7,90
CQ-46/60	[C] R2035L.	60	0	360x520x75	8,10

CSB-A, Fixed capacitors with automatic protection 50 Hz

Type	Code	400 V kvar	440 V kvar	Cut off power	Aut.Switch (A)	Cable section (mm ²)	Size (mm) width x height x depth	weight (kg)
CSB-A- 25 - 440	[2] R2473H.	21	25	50 kA	63	16	360x814x196	15,00
CSB-A- 37,5 - 440	[2] R2473G.	31	37.5	50 kA	80	25	360x814x196	11,00
CSB-A- 50 - 440	[2] R2473J.	42	50	50 kA	100	25	360x814x196	16,00
CSB-A- 60 - 440	[2] R2473K.	50	60	50 kA	125	35	360x814x196	20,00
CSB-A- 75 - 440	[2] R2473L.	62	75	50 kA	160	50	360x100x196	21,00
CSB-A- 100 - 440	[2] R2473M.	83	100	50 kA	200	70	360x100x196	26,00
CSB-A- 120 - 440	[2] R2473N.	100	120	50 kA	250	95	360x100x196	28,00



CSB-M, Power capacitors with circuit breaker protection

CSB-M 230 Vac / 50 Hz. - 440 Vac / 50 Hz.

Type	Code	230 V kvar	Cut off power	Aut.Switch (A)	Cable section (mm ²)	Size (mm) width xheight xdepth	weight (kg)	
230 Vac, 50 Hz								
CSB-M - 5 - 230	[1] R23718.	5	6 kA	20	6	140x381x280	9,00	
CSB-M - 7,5 - 230	[1] R2371A.	7.5	6 kA	32	6	140x381x280	9,20	
CSB-M - 10 - 230	[1] R2371C.	10	6 kA	40	10	140x381x280	9,50	
CSB-M - 12,5 - 230	[1] R2371D.	12.5	6 kA	50	10	140x381x280	9,50	
CSB-M - 15 - 230	[1] R2371E.	15	6 kA	63	16	140x381x280	11,30	
CSB-M - 20 - 230	[1] R2371F.	20	10 kA	80	25	140x381x280	11,80	
CSB-M - 25 - 230	[1] R2371G.	25	10 kA	100	35	140x381x280	10,80	
CSB-M - 30 - 230	[1] R2371H.	30	10 kA	125	50	140x381x280	10,80	
Type	Code	400 V kvar	440 V kvar	Cut off power (A)	Aut.Switch (A)	Cable section (mm ²)	Size (mm) width xheight xdepth	weight (kg)
440 Vac, 50 Hz								
CSB-M- 5 - 440	[1] R23948.	4	5	6 kA	10	6	140x381x280	8,00
CSB-M- 7,5 - 440	[1] R2394A.	6	7.5	6 kA	16	6	140x381x280	8,00
CSB-M- 10 - 440	[1] R2394C.	8	10	6 kA	20	6	140x381x280	8,00
CSB-M- 12,5 - 440	[*] R2394D.	10	12.5	6 kA	25	6	140x381x280	8,50
CSB-M- 15 - 440	[1] R2394E.	12.5	15	6 kA	32	6	140x381x280	8,50
CSB-M- 20 - 440	[*] R2394F.	17	20	6 kA	40	10	140x381x280	9,50
CSB-M- 25 - 440	[*] R2394G.	21	25	6 kA	50	10	140x381x280	9,50
CSB-M- 30 - 440	[*] R2394H.	25	30	6 kA	63	16	140x381x280	11,00
CSB-M- 37,5 - 440	[*] R2394J.	31	37.5	10 kA	80	25	140x381x280	12,50
CSB-M- 50 - 440	[*] R2394K.	42	50	10 kA	100	35	140x381x280	15,00
CSB-M- 60 - 440	[*] R2394L.	50	60	10 kA	125	50	140x571x280	16,00
CSB-M- 75 - 440	[*] R2394M.	66	75	10 kA	160	50	140x571x280	18,00



CSB-F, Power capacitors with fuse protection

CSB-F 230 Vac / 50 Hz. - 440 Vac / 50 Hz.

Type	Code	230 V kvar	Cut off power	Fuses (A)	Cable section (mm ²)	Size (mm) width xheight xdepth	weight (kg)	
230 V, 50 Hz								
CSB-F - 5 - 230	[1] R23618.	5	50 kA	20	6	140x381x280	9,00	
CSB-F - 7,5 - 230	[1] R2361A.	7.5	50 kA	35	6	140x381x280	9,20	
CSB-F - 10 - 230	[1] R2361C.	10	50 kA	50	10	140x381x280	9,50	
CSB-F - 12,5 - 230	[1] R2361D.	12.5	50 kA	63	10	140x381x280	9,50	
CSB-F - 15 - 230	[1] R2361E.	15	50 kA	80	16	140x381x280	11,30	
CSB-F - 20 - 230	[1] R2361F.	20	50 kA	100	25	140x381x280	11,80	
CSB-F - 25 - 230	[1] R2361G.	25	50 kA	125	35	140x381x280	10,80	
CSB-F - 30 - 230	[1] R2361H.	30	50 kA	160	50	140x381x280	10,80	
CSB-F - 40 - 230	[1] R2361J.	40	50 kA	160	70	140x571x280	14,50	
Type	Code	400 V kvar	440 V kvar	Cut off power	Fuses (A)	Cable section (mm ²)	Size (mm) width xheight xdepth	weight (kg)
440 V, 50 Hz								
CSB-F- 5 - 440	[1] R23958.	4	5	50 kA	16	6	140x381x280	8,00
CSB-F- 7,5 - 440	[1] R2395A.	6	7.5	50 kA	20	6	140x381x280	8,00
CSB-F- 10 - 440	[1] R2395C.	8	10	50 kA	25	6	140x381x280	8,00
CSB-F- 12,5 - 440	[1] R2395D.	10	12.5	50 kA	35	6	140x381x280	8,50
CSB-F- 15 - 440	[1] R2395E.	12.5	15	50 kA	50	6	140x381x280	8,50
CSB-F- 20 - 440	[1] R2395F.	17	20	50 kA	50	10	140x381x280	9,50
CSB-F- 25 - 440	[1] R2395G.	21	25	50 kA	50	10	140x381x280	9,50
CSB-F- 30 - 440	[1] R2395H.	25	30	120 kA	80	16	140x381x280	11,00
CSB-F- 37,5 - 440	[1] R2395J.	31	37.5	120 kA	100	25	140x381x280	12,50
CSB-F- 50 - 440	[1] R2395K.	42	50	120 kA	125	35	140x381x280	15,00
CSB-F- 60 - 440	[1] R2395L.	50	60	120 kA	160	50	140x571x280	16,00
CSB-F- 75 - 440	[1] R2395P.	63	75	120 kA	160	70	140x571x280	18,00
CSB-F- 100 - 440	[1] R2395Q.	80	100	120 kA	160	70	140x571x280	18,50

OPTIM-FRF, Fixed capacitors with rejection reactance of p = 7%

Protección por fusibles APR, 440 V, 50 Hz

Type	Code	400 V kvar	440 V kvar	Cable section (mm ²)	Size (mm) width xheight xdepth	weight (kg)
OPTIM FRF, fuse protection APR, 440 V, 50 Hz						
OPTIM FRF-25-440	[2] R5X350.	21	25	10	650x1060x420	78,00
OPTIM FRF-37,5-440	[2] R5X370.	31	37.5	16	650x1060x420	82,00
OPTIM FRF-50-440	[2] R5X380.	42	50	25	650x1060x420	85,00
OPTIM FRF-60-440	[2] R5X390.	50	60	35	650x1060x420	90,00
OPTIM FRF-75-440	[2] R5X3A0.	62	75	50	650x1060x420	96,00
OPTIM FRF-100-440	[2] R5X3B0.	83	100	70	650x1060x420	110,00

OPTIM-FRM, Fixed capacitors with rejection reactance of p = 7%

Protección por automático tripolar, 440 V, 50 Hz

Type	Code	400 V kvar	440 V kvar	Cable section (mm ²)	Size (mm) width xheight xdepth	weight (kg)
OPTIM FRM, automatic tricolor protection, 440 V, 50 Hz						
OPTIM FRM-25-440	[2] R5Y350.	21	25	10	650x1060x420	78,00
OPTIM FRM-37,5-440	[2] R5Y370.	31	37.5	16	650x1060x420	82,00
OPTIM FRM-50-440	[2] R5Y380.	42	50	25	650x1060x420	85,00
OPTIM FRM-60-440	[2] R5Y390.	50	60	35	650x1060x420	90,00
OPTIM FRM-75-440	[2] R5Y3A0.	62	75	50	650x1060x420	96,00
OPTIM FRM-100-440	[2] R5Y3B0.	83	100	70	650x1060x420	110,00

CLP-C, CLZ Capacitor with circuit breaker and contactor

Type	Code	440 V kvar	Cut off power	IP	Size (mm) width xheight xdepth	weight (kg)
440 Vac / 50Hz						
CLP-C-44/2,5	[C] R22574.	2.5	6 kA	20	215x490x147	3,28
CLP-C-44/3	[C] R22575.	3	6 kA	20	215x490x147	3,94
CLP-C-44/5	[C] R22578.	5	6 kA	20	215x490x147	6,57
CLP-C-44/6,25	[C] R22579.	6.25	6 kA	20	215x490x147	8,21
CLP-C-44/7,5	[C] R2257A.	7.5	6 kA	20	215x490x147	9,85
CLP-C-44/10	[C] R2257C.	10	6 kA	20	215x490x147	13,00
CLP-C-44/12,5	[C] R2257D.	12.5	6 kA	20	215x490x147	16,00
CLP-C-44/15	[C] R2257E.	15	6 kA	20	215x490x147	20,00
CLP-C-44/20	[C] R2257F.	20	6 kA	20	215x490x147	26,00
CLP-C-44/25	[C] R2257G.	25	6 kA	20	215x490x147	33,00

CLP, Power capacitor with circuit breaker

Type	Code	440 V kvar	Cut off power	IP	Size (mm) width xheight xdepth	weight (kg)
440 Vac / 50Hz						
CLP-44/2,5	[2] R21574.	2.5	6 kA	20	80x350x85	3,28
CLP-44/3	[2] R21575.	3	6 kA	20	80x350x85	3,94
CLP-44/5	[2] R21578.	5	6 kA	20	80x350x85	6,57
CLP-44/6,25	[2] R21579.	6.25	6 kA	20	80x350x85	8,21
CLP-44/7,5	[2] R2157A.	7.5	6 kA	20	80x350x85	9,85



ACF, CSB capacitor with contactor and fuses

Type	Code	230 V kvar	Cut off power	Fuses (A)	Cable section (mm ²)	IP	Size (mm) width xheight xdepth	weight (kg)
230 V / 50 Hz								
ACF-20-230	[1] R3S141.	20	120 kA	125	25	50	360x814x196	17,00
ACF-25-230	[1] R3S151.	25	120 kA	125	35	63	360x1004x196	21,00
ACF-30-230	[1] R3S161.	30	120 kA	160	50	75	360x1004x196	22,00
ACF-40-230	[1] R3S181.	40	120 kA	160	70	100	360x1004x196	27,00

Type	Code	400 V kvar	440 V kvar	Cut off power	Fuses (A)	Cable section (mm ²)	IP	Size (mm) width xheight xdepth	weight (kg)
440 V / 50 Hz									
ACF-12,5-440	[1] R3S421.	10	12.5	120 kA	35	6	16	360x814x196	12,00
ACF-15-440	[1] R3S431.	12.5	15	120 kA	35	10	20	360x814x196	13,00
ACF-20-440	[1] R3S441.	17	20	120 kA	50	10	26	360x814x196	14,00
ACF-25-440	[1] R3S451.	21	25	120 kA	63	10	33	360x814x196	15,00
ACF-30-440	[1] R3S461.	25	30	120 kA	80	16	39	360x814x196	16,00
ACF-37,5-440	[1] R3S481.	31	37.5	120 kA	80	25	49	360x814x196	17,00
ACF-50-440	[1] R3S491.	42	50	120 kA	125	35	66	360x814x196	21,00
ACF-60-440	[1] R3S4A1.	50	60	120 kA	160	50	79	360x1004x196	22,00
ACF-75-440	[1] R3S4B1.	63	75	120 kA	160	70	99	360x1004x196	24,00
ACF-100-440	[1] R3S4D1.	80	100	120 kA	160	70	131	360x1004x196	29,00

Switch and cable cross-section for installations with Un= 400 V. The installation company must ensure compliance with the low voltage directive at all times, in accordance with the particularities of each installation and type of cable

Supplement selection table to adapt CSB / CFB capacitor height to a capacitor bank equipped with CS / CF capacitors

CS / CF Capacitor TO REPLACE		CSB / CFB NEW capacitor			
Total capacitor height (box + terminals) (mm)	Height box capacitor (mm)	Total heigh of capacitor (box+terminals) (mm)	Capacitor box height (mm)		
390	330	330	270	SP-60	[*] R2ZZZ1
610	550	520	460	SP-90	[*] R2ZZZ2
760	700	610	550	SP-150	[*] R2ZZZ3

Dimensions

CSB / CFB

CLZ-FP

mm	d Ø	h	B	A Ø
85x175	85	175	31	90
85x245	85	245	31	90
100x245	100	245	31	105
116x245	116	245	35	121
136x220	136	220	35	141
136x261	136	261	35	141
136x355	136	355	46	141

CLZ-FPT

mm	d Ø	h	B	A Ø
63,5x98	63,5	98	13	68,5
63,5x127	63,5	127	13	68,5
63,5x175	63,5	175	13	68,5
63,5x202	63,5	202	13	68,5

Dimensions

CSB-F / CSB-M

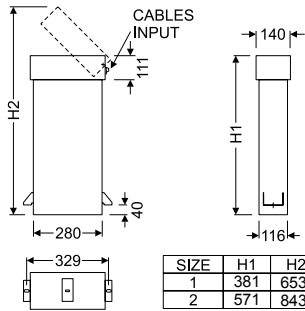

CSB-A

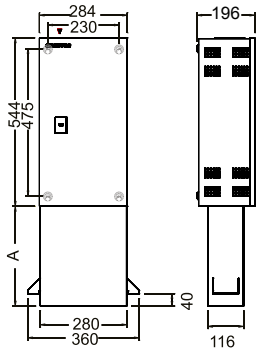

ACF

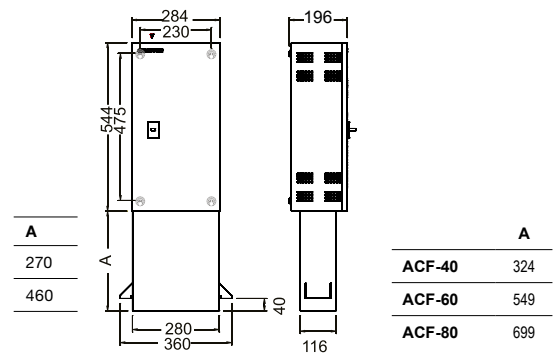

CV

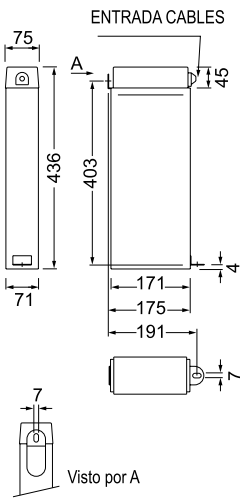

CQ

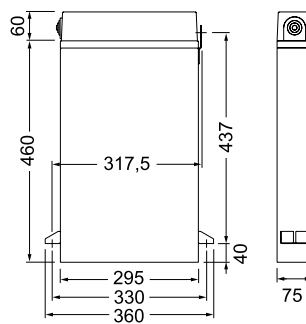

OPTIM FRF / OPTIM FRM

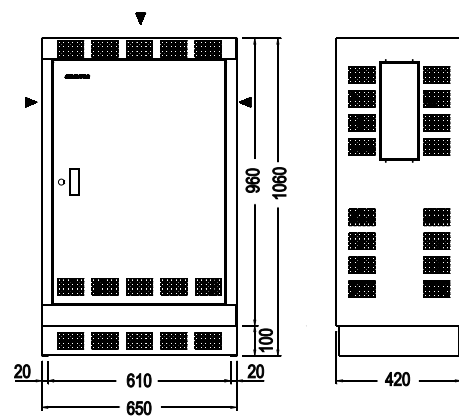

RX / RE

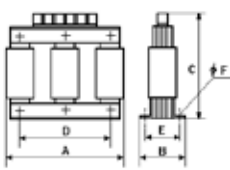

RBX / RBE

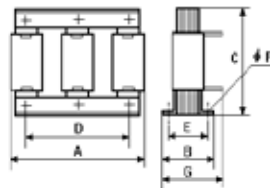

Type	A mm	B mm	C mm	D* mm	E* mm	F mm	G mm	kg
RX-5-400	155	90	165	75	70	7	--	5
RX-6,24-400	180	100	190	90	75	7	--	7
RX-10-400	180	100	190	90	75	7	--	7,5
RX-12,5-400	180	110	190	90	85	7	--	8
RX-15-400	180	110	190	90	85	7	--	8,5
RBX-20-400	235	125	165	150	95	9	145	14
RBX-25-400	235	125	165	150	95	9	145	14
RBX-30-400	255	125	200	160	95	9	150	19
RBX-40-400	255	125	200	160	95	9	150	20
RBX-50-400	255	145	220	160	115	9	175	25
RBX-60-400	280	145	240	180	115	9	175	28
RBX-80-400	305	155	235	180	121	11	190	31

Type	A mm	B mm	C mm	D* mm	E* mm	F mm	G mm	kg
RE-05-400	155	92	165	75	70	7	-	6
RE-10-400	180	102	190	90	75	7	-	8
RE-15-400	180	112	190	90	85	7	-	9,5
RE-20-400	180	122	190	90	95	7	-	11,5
RE-25-400	240	122	250	130	90	9	-	17
RE-30-400	240	132	250	130	100	9	-	20,5
RE-40-400	240	147	250	130	115	9	-	25,5
RBE-50-400	310	154	233	160	120	9	185	29
RBE-60-400	338	154	234	180	120	9	185	30
RBE-80-400	338	154	254	180	120	11	190	41

* Distance between fixings

Low voltage capacitor banks

Table: Selection of the reactive energy compensation unit

				Page
Multiple loads	Slow variations	without harmonics	OPTIM 2 / OPTIM P&P	134
		with harmonics	OPTIM FR P&P	136
			FAR-Q	147
	Semi-quick variations		OPTIM HYB	compensación fase a fase redes desequilibradas 135
Quick variations		without harmonics	OPTIM EMS-C / OPTIM EMK	139
		with harmonics	OPTIM FRE	Elimination of resonances 140

Table: Selection of the OPTIM





	OPTIM 1	OPTIM 2	OPTIM 3 P&P / 5 P&P	OPTIM 9 P&P / 8 P&P	OPTIM 8L / 14L / 16L
					
Rated voltage	440 V	440 V	440 V	440 V	440 V
Service voltage	400 V	400 V	400 V	400 V	400 V
Power range at rated voltage	2,5 ... 30 kvar	7,5 ... 30 kvar	OPTIM 3: 12,5 ... 62,5 kvar OPTIM 5: 55 ... 150 kvar	OPTIM 9: 165 ... 270 kvar OPTIM 8: 300 ... 480 kvar	OPTIM 8L: 450 a 800 kvar OPTIM 14L: 900 a 1400 kvar OPTIM 16L: 1500 a 1600 kvar
Contactor switching	•	•	•	•	•
No. Steps (maximum)	1	2	3 / 5	9 / 8	8 / 14 / 16
Enclosure	Thermoplastic IP 21	•	–	–	–
	Metallic IP 21	–	–	•	•
Installation (indoor)	•	•	•	•	•
Assembly	Wall-mounted	•	•	–	–
	Floor-mounted	–	–	o	o
Regulator	•	–	–	–	–
	–	•	–	–	–
	–	–	•	•	•
	–	–	Optional	Optional	Optional
Capacitor	Cylindrical CLZ	•	•	•	•
Built-in protection	General circuit breaker	•	•	–	–
	APR NH-00 Fuses	–	–	–	•

Table: Recommended capacitor bank power ratings - 7.5 to 105 kvar

kvar	Recommended capacitor bank	Electrical steps (kvar)
De 7,5 kvar a 17,5 kvar	OPTIM 3-P&P-17,5-440	7 x 2,5
De 17,5 kvar a 31,25 kvar	OPTIM 3-P&P-31,25-440	5 x 6,25
De 31,25 kvar a 43,75 kvar	OPTIM 3-P&P-43,75-440	7 x 6,25
De 43,75 kvar a 55 kvar	OPTIM 5-P&P-55-440	11 x 5
De 55 kvar a 70 kvar	OPTIM 5-P&P-70-440	7 x 10
De 75 kvar a 105 kvar	OPTIM 5-P&P-105-440	15 + 3 x 30



OPTIM P&P, Automatic capacitor banks, 2.5 to 1600 kvar

Type	Code	400 V kvar	440 V kvar	Composition	Aut. Switch (A)	Man. Switch (A)	Cable section (mm ²)	Size (mm) width xheight xdepth	weight (kg)
OPTIM 1, automatic capacitor bank with reactive relay. Requires one measuring transformer - MC series 250 mA (see Measuring current Transformers)									
OPTIM 1-2,5-440	[*] R3Q631EN00000	2	2.5	1 x 2,5	-	Included	6	215x500x166	4,00
OPTIM 1-5-440	[*] R3Q641EN00000	4	5	1 x 5	-	Included	6	215x500x166	4,50
OPTIM 1-6,25-440	[*] R3Q651EN00000	5	6.25	1 x 6,25	-	Included	6	215x500x166	5,00
OPTIM 1-10-440	[*] R3Q671EN00000	8	10	1 x 10	-	Included	6	215x500x166	5,00
OPTIM 1-12,5-440	[*] R3Q681EN00000	10	12.5	1 x 12,5	-	Included	6	215x500x166	5,00
OPTIM 1-15-440	[*] R3Q691EN00000	12.5	15	1 x 15	-	Included	6	215x500x166	5,00
OPTIM 1A-18,2-440	[*] R3Q6E1EN00000	15	18.2	1 x 18,2	-	Included	6	270x500x166	6,00
OPTIM 1A-25-440	[*] R3Q6F1EN00000	20	25	1 x 25	-	Included	10	270x500x166	7,00
OPTIM 1A-30-440	[*] R3Q6D1EN00000	25	30	1 x 30	-	Included	10	270x500x166	7,00
OPTIM 2, automatic capacitor banks with regulator without display. Requires one measuring transformer - MC series 250 mA (see Measuring current Transformers)									
OPTIM 2-7,5-440	[*] R3Q761EN00000	6.25	7.5	2,5 + 5	-	Included	6	362x500x166	7,00
OPTIM 2-10,5-440	[1] R3Q771EN00000	8.5	10.5	3 + 7,5	-	Included	6	362x500x166	7,00
OPTIM 2-12,5-440	[*] R3Q781EN00000	10	12.5	5 + 7,5	-	Included	6	362x500x166	7,00
OPTIM 2-17,5-440	[1] R3Q7E1EN00000	14	17.5	5 + 12,5	-	Included	6	362x500x166	7,00
OPTIM 2-20-440	[1] R3Q7F1EN00000	16.5	20	7,5 + 12,5	-	Included	6	362x500x166	7,00
OPTIM 2-22,5-440	[*] R3Q7G1EN00000	18.5	22.5	7,5 + 15	-	Included	6	362x500x166	7,00
OPTIM 2-25-440	[1] R3Q7H1EN00000	21	25	10 + 15	-	Included	10	362x500x166	8,00
OPTIM 2-30-440	[1] R3Q7J1EN00000	25	30	15 + 15	-	Included	10	362x500x166	8,00
OPTIM 3 P&P, automatic capacitor banks with computer Max P&P regulator									
OPTIM 3 P&P-12,5-440	[*] R3L110.	10	12.5	2,5+5+5	-	Included	6	400x600x260	22,00
OPTIM 3 P&P-17,5-440	[*] R3L120.	14	17.5	2,5+5+10	-	Included	6	400x600x260	23,00
OPTIM 3 P&P-25-440	[*] R3L130.	20	25	5+10+10	-	Included	10	400x600x260	23,00
OPTIM 3 P&P-31,25-440	[*] R3L140.	26	31.25	6,25+12,5+12,5	-	Included	10	400x600x260	23,00
OPTIM 3 P&P-37,5-440	[*] R3L150.	31.25	37.5	7,5+15+15	-	Included	16	400x600x260	24,00
OPTIM 3 P&P-43,75-440	[*] R3L160.	36	43.75	6,25+12,5+25	-	Included	25	400x600x260	25,00
OPTIM 3 P&P-52,5-440	[1] R3L170.	43	52.5	7,5+15+30	-	Included	25	400x600x260	27,00
OPTIM 3 P&P-62,5-440	[1] R3L180.	51	62.5	12,5+25+25	-	Included	35	400x600x260	29,00
OPTIM 5 P&P, automatic capacitor banks with computer Max P&P regulator									
OPTIM 5 P&P-55-440	[*] R3L210.	45	55	5+10+20+20	125	200	35	600x740x260	37,00
OPTIM 5 P&P-70-440	[*] R3L220.	58	70	10+3x20	125	200	50	600x740x260	38,00
OPTIM 5 P&P-90-440	[1] R3L230.	74	90	15+15+30+30	200	200	70	600x740x260	40,00
OPTIM 5 P&P-105-440	[*] R3L240.	87	105	15+30+30+30	200	200	70	600x740x260	41,00
OPTIM 5 P&P-135-440	[1] R3L250.	112	135	15+30+30+30+30	250	250	95	600x740x260	45,00
OPTIM 5 P&P-150-440	[1] R3L260.	124	150	30+30+30+30+30	250	250	120	600x740x260	46,00
OPTIM 9 P&P, automatic capacitor banks with computer Max P&P regulator. Built-in power supply autotransformer									
OPTIM 9 P&P-165-440	[*] R3L310.	136	165	15+5x30	400	400	120	700x1350x440	81,00
OPTIM 9 P&P-195-440	[1] R3L320.	161	195	15+6x30	400	400	150	700x1350x440	86,00
OPTIM 9 P&P-225-440	[*] R3L330.	186	225	15+7x30	400	400	185	700x1350x440	92,00
OPTIM 9 P&P-255-440	[1] R3L340.	211	255	15+8x30	630	630	240	700x1350x440	98,00
OPTIM 9 P&P-270-440	[1] R3L350.	223	270	9x30	630	630	240	700x1350x440	100,00
OPTIM 8 P&P, automatic capacitor banks with computer Max P&P regulator. Built-in power supply autotransformer									
OPTIM 8 P&P-300-440	[1] R3L410.	248	300	2x30+4x60	630	630	2x150	1000x1750x440	135,00
OPTIM 8 P&P-330-440	[1] R3L420.	273	330	30+5x60	630	630	2x150	1000x1750x440	140,00
OPTIM 8 P&P-390-440	[1] R3L430.	322	390	30+6x60	800	800	2x185	1000x1750x440	150,00
OPTIM 8 P&P-450-440	[1] R3L440.	372	450	30+7x60	800	800	2x240	1000x1750x440	160,00
OPTIM 8 P&P-480-440	[1] R3L450.	396	480	8x60	1000	1000	2x240	1000x1750x440	163,00
OPTIM 8L P&P, automatic capacitor banks with computer Max P&P regulator. Built-in power supply autotransformer									
OPTIM 8L P&P-550-440	[1] R35L10.	454	550	50+5x100	1000	1000	2x240	1200x1900x650	220,00
OPTIM 8L P&P-650-440	[1] R35L20.	537	650	50+6x100	1250	1600	3x150	1200x1900x650	255,00
OPTIM 8L P&P-750-440	[1] R35L30.	620	750	50+7x100	1600	1600	3x185	1200x1900x650	280,00
OPTIM 8L P&P-800-440	[1] R35L40.	661	800	8x100	1600	1600	3x185	1200x1900x650	290,00
OPTIM 14L P&P, automatic capacitor banks with computer Max P&P regulator. Built-in power supply autotransformer									
OPTIM 14L P&P-900-440	[2] R36L10.	743	900	2x50+8x100	1250+400	1600+400	3x150/185	2100x1900x650	435,00
OPTIM 14L P&P-950-440	[2] R36L20.	785	950	50+9x100	1600+400	1600+400	3x185/185	2100x1900x650	445,00
OPTIM 14L P&P-1050-440	[2] R36L30.	867	1050	50+10x100	1600+630	1600+630	3x185/240	2100x1900x650	470,00
OPTIM 14L P&P-1150-440	[2] R36L40.	950	1150	50+11x100	1600+1000	1600+1000	3x185/2x150	2100x1900x650	495,00
OPTIM 14L P&P-1200-440	[2] R36L50.	991	1200	12x100	1600+800	1600+800	3x185/2x185	2100x1900x650	505,00
OPTIM 14L P&P-1300-440	[2] R36L60.	1074	1300	100+6x200	1250+1250	1600+1600	3x185/2x240	2100x1900x650	535,00
OPTIM 14L P&P-1400-440	[2] R36L70.	1156	1400	100+100+6x200	1600+1250	1600+1600	3x185/3x120	2100x1900x650	560,00
OPTIM 16L P&P-1500-440	[2] R37L30.	1239	1500	100+7x200	1600+1600	1600+1600	3x185/3x150	2400x1900x650	570,00
OPTIM 16L P&P-1600-440	[2] R37L40.	1322	1600	100+100+7x200	1600+1600	1600+1600	3x185/3x185	2400x1900x650	580,00

Switch and cable cross-section for installations with Un= 400 V. The installation company must ensure compliance with the low voltage directive at all times, in accordance with the characteristics of each installation and type of cable.

Delivery time: [*] immediate
[x] working weeks
[c] consult

OPTIM HYB, Semi-fast hybrid automatic capacitor banks with phase-by-phase compensation for unbalanced networks

OPTIM HYB



Rated voltage	3 x 440 V + 1 x 254 V
Power range at rated voltage (50 Hz)	90...540 kvar
switching	Contactor + thyristor
No. Steps (maximum)	6 + 9
Enclosure	Metallic IP 21
Installation	Indoor
Assembly	floor-mounted
Regulator	computer HYB
Capacitor	Cylindrique CLZ
Built-in protection	Circuit breaker for step

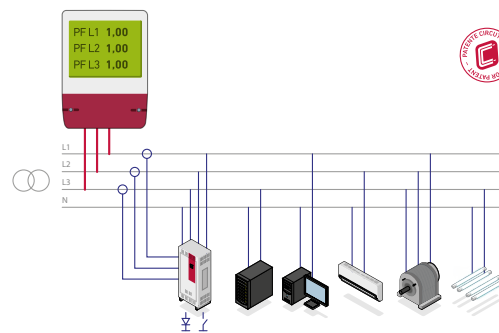

OPTIM HYB, Semi-fast hybrid automatic capacitor banks with phase-by-phase compensation for unbalanced networks



Type	Code	400 V kvar	440 V kvar	Composition 230V/50Hz (Single-phase)	Composition 400V/50Hz (Three-phase)	Man. Switch (A)	Cable section (mm2)	Size (mm) width xheight xdepth	weight (kg)
OPTIM HYB1-90-440	[C] R4E103.	75	90	(3 x 2 x 5) +	(3 x 15)	Included	1 x 95	685x970x340	67,00
OPTIM HYB1-110-440	[C] R4E104.	90	110	(3 x 2 x 5) +	(4 x 15)	Included	1 x 95	685x970x340	71,00
OPTIM HYB2-160-440	[C] R4E105.	135	165	(3 x 3 x 5) +	(3 x 30)	Included	1 x 120	800x1840x640	146,00
OPTIM HYB2-200-440	[C] R4E106.	165	200	(3 x 3 x 5) +	(4 x 30)	Included	1 x 185	800x1840x640	152,00
OPTIM HYB2-270-440	[C] R4E108.	225	270	(3 x 3 x 5) +	(6 x 30)	Included	1 x 240	800x1840x640	163,00
OPTIM HYB2-325-440	[C] R4E113.	270	325	(3 x 3 x 10) +	(3 x 60)	Included	2 x 150	800x1840x640	229,00
OPTIM HYB3-400-440	[C] R4E114.	330	400	(3 x 3 x 10) +	(4 x 60)	Included	2 x 240	1000x1840x640	304,00
OPTIM HYB3-470-440	[C] R4E115.	390	470	(3 x 3 x 10) +	(5 x 60)	Included	2 x 240	1000x1840x640	325,00
OPTIM HYB3-540-440	[C] R4E116.	450	540	(3 x 3 x 10) +	(6 x 60)	Included	2 x 240	1000x1840x640	336,00

Table: selection capacitor banks with rejection filters

	OPTIM FRM /OPTIM FRF	OPTIM FRS P&P	OPTIM FR P&P
Rated voltage	440 V	440 V	440 V
Service voltage	400 V	400 V	400 V
Power range at rated voltage (50 Hz)	25... 100 kvar	31,25 ... 120 kvar	OPTIM FR4 P&P: 150 a 400 kvar OPTIM FR6 P&P: 400 a 600 kvar OPTIM FR8 P&P: 600 a 800 kvar OPTIM FR10 P&P: 800 a 1000 kvar OPTIM FR12 P&P: 1050 a 1200 kvar
Contactor switching	-	•	•
No. Steps (maximum)	1	4	4 / 6 / 8 / 10 / 12
Enclosure	Metallic IP 21	•	•
Installation (indoor)	•	•	•
Assembly (floor-mounted)	•	•	•
Regulator	Computer Max P&P	•	•
	Computer Smart III	Optional	Optional
Capacitor	Cylindrical CLZ	•	•
Reactors tuned to 189 Hz (ask if you require other tuning values)	•	•	•
Built-in protection	General circuit breaker	Depending on type	•
	APR NH-00 Fuses	Depending on type	-
Autotransformer for aux. supply	-	•	•

OPTIM FRF, Fixed capacitors with rejection reactance of p = 7%

Type	Code	400 V kvar	440 V kvar	Cable section (mm ²)	Size (mm) width xheight xdepth	weight (kg)
OPTIM FRF, fuse protection APR, 440 V, 50 Hz						
OPTIM FRF-25-440	[2] R5X350.	21	25	10	650x1060x420	78,00
OPTIM FRF-37,5-440	[2] R5X370.	31	37.5	16	650x1060x420	82,00
OPTIM FRF-50-440	[2] R5X380.	42	50	25	650x1060x420	85,00
OPTIM FRF-60-440	[2] R5X390.	50	60	35	650x1060x420	90,00
OPTIM FRF-75-440	[2] R5X3A0.	62	75	50	650x1060x420	96,00
OPTIM FRF-100-440	[2] R5X3B0.	83	100	70	650x1060x420	110,00

OPTIM FRM, Fixed capacitors with rejection reactance of p = 7%

Mounted on a metal cabinet. Floor mounted

Type	Code	400 V kvar	440 V kvar	Cable section (mm ²)	Size (mm) width xheight xdepth	weight (kg)
OPTIM FRM, automatic tricolor protection, 440 V, 50 Hz						
OPTIM FRM-25-440	[2] R5Y350.	21	25	10	650x1060x420	78,00
OPTIM FRM-37,5-440	[2] R5Y370.	31	37.5	16	650x1060x420	82,00
OPTIM FRM-50-440	[2] R5Y380.	42	50	25	650x1060x420	85,00
OPTIM FRM-60-440	[2] R5Y390.	50	60	35	650x1060x420	90,00
OPTIM FRM-75-440	[2] R5Y3A0.	62	75	50	650x1060x420	96,00
OPTIM FRM-100-440	[2] R5Y3B0.	83	100	70	650x1060x420	110,00

See CFB capacitor and RX /RBX reactor components in the Low Voltage Capacitor and Reactor Section

OPTIM FR P&P, Automatic capacitor banks with rejection filters (contactors switching)

Type	Code	400 V kvar	440 V kvar	Composition	Aut.Switch (A)	Man. Switch (A)	Cable section (mm ²)	Size (mm) width xheight xdepth	weight (kg)
OPTIM FRS P&P									
OPTIM FRS-P&P-31,25-440	[2] R54R64.	26	31.25	6,25 + 2 x 12,5	-	-	10	800x1200x500	102,00
OPTIM FRS-P&P-43,75-440	[2] R54R74.	36	43.75	6,25 + 12,5 + 25	-	-	25	800x1200x500	108,00
OPTIM FRS-P&P-62,5-440	[2] R54R81.	52	62.5	12,5 + 2 x 25	-	-	35	800x1200x500	115,00
OPTIM FRS-P&P-90-440	[2] R54R88.	74	90	2 x 15 + 2 x 30	-	-	70	800x1200x500	133,00
OPTIM FRS-P&P-105-440	[2] R54R92.	87	105	15 + 3 x 30	-	-	70	800x1200x500	138,00
OPTIM FRS-P&P-120-440	[2] R54R95.	99	120	4 x 30	-	-	95	800x1200x500	143,00
OPTIM FR4 P&P									
OPTIM FR4-P&P-150-440	[2] R54S24.	125	150	30 + 2 x 60	400	400	95	900x1900x650	220,00
OPTIM FR4-P&P-175-440	[2] R54S25.	145	175	25 + 50 + 100	400	400	120	900x1900x650	225,00
OPTIM FR4-P&P-200-440	[2] R54S28.	165	200	50 + 50 + 100	400	400	150	900x1900x650	235,00
OPTIM FR4-P&P-250-440	[2] R54S29.	207	250	50 + 2 x 100	630	630	185	900x1900x650	250,00
OPTIM FR4-P&P-300-440	[2] R54S30.	248	300	50 + 50 + 2 x 100	630	630	240	900x1900x650	290,00
OPTIM FR4-P&P-350-440	[2] R54S32.	289	350	50 + 3 x 100	630	630	2x150	900x1900x650	310,00
OPTIM FR4-P&P-400-440	[2] R54S34.	331	400	4 x 100	800	800	2x150	900x1900x650	335,00
OPTIM FR6 P&P									
OPTIM FR6-P&P-400-440	[2] R54T25.	331	400	50 + 50 + 3 x 100	800	800	2x185	1200x1900x650	370,00
OPTIM FR6-P&P-450-440	[2] R54T30.	372	450	50 + 4 x 100	800	800	2x185	1200x1900x650	400,00
OPTIM FR6-P&P-500-440	[2] R54T35.	413	500	5 x 100	1000	1000	2x240	1200x1900x650	440,00
OPTIM FR6-P&P-550-440	[2] R54T40.	455	550	50 + 5 x 100	1000	1000	2x240	1200x1900x650	465,00
OPTIM FR6-P&P-600-440	[2] R54T45.	496	600	6 x 100	1250	1600	2x240	1200x1900x650	490,00
OPTIM FR8 P&P									
OPTIM FR8-P&P-600-440	[2] R54U36.	496	600	50 + 50 + 5 x 100	1250	1600	2x240	1500x1900x650	525,00
OPTIM FR8-P&P-650-440	[2] R54U38.	537	650	50 + 6 x 100	1250	1600	3x150	1500x1900x650	540,00
OPTIM FR8-P&P-700-440	[2] R54U40.	579	700	7 x 100	1250	1600	3x150	1500x1900x650	555,00
OPTIM FR8-P&P-750-440	[2] R54U42.	620	750	50 + 7 x 100	1600	1600	3x185	1500x1900x650	580,00
OPTIM FR8-P&P-800-440	[2] R54U44.	661	800	8 x 100	1600	1600	3x185	1500x1900x650	605,00
OPTIM FR10 P&P									
OPTIM FR10-P&P-800-440	[2] R54V25.	661	800	8 x 100	1250+400	1600+400	2x240/ 240	2100x1900x650	695,00
OPTIM FR10-P&P-850-440	[2] R54V30.	702	850	50 + 8 x 100	1000+630	1000+630	2x240/ 240	2100x1900x650	735,00
OPTIM FR10-P&P-900-440	[2] R54V35.	744	900	9 x 100	1250+630	1600+630	2x240/ 240	2100x1900x650	775,00
OPTIM FR10-P&P-950-440	[2] R54V40.	785	950	50 + 9 x 100	1000+800	1000+800	2x240/ 2x185	2100x1900x650	800,00
OPTIM FR10-P&P-1000-440	[2] R54V45.	826	1000	10 x 100	1250+800	1600+800	2x240/ 2x185	2100x1900x650	825,00
OPTIM FR12-P&P-1050-440	[2] R54W50.	868	1050	50 + 10 x 100	1250+800	1600+800	2x240/ 2x240	2400x1900x650	890,00
OPTIM FR12-P&P-1100-440	[2] R54W55.	909	1100	11 x 100	1250+1000	1600+1000	2x240/ 2x240	2400x1900x650	930,00
OPTIM FR12-P&P-1150-440	[2] R54W60.	950	1150	50 + 11 x 100	2x1250	2x1600	2x240/ 2x240	2400x1900x650	955,00
OPTIM FR12-P&P-1200-440	[2] R54W65.	992	1200	12 x 100	2x1250	2x1600	2x240/ 2x240	2400x1900x650	980,00

Switch and cable cross-section for installations with Un= 400 V. The installation company must ensure compliance with the low voltage directive at all times, in accordance with the particularities of each installation and type of cable.

 Delivery time: [*] immediate
 [x] working weeks
 [c] consult

CODIFICATION TABLE

Code		Internal code									
R	3	X	X	X	X	0	0	X	X	X	
								↑	↑	↑	Delivery time
Options	Standard (*)							0			-
	Autotransformer for aux. supply							1			-
	Fan							2			-
	Policarbonate							3			-
	Autotransf. + Fan							4			-
	Autotransf. + Policarbonate							5			-
	Policarbonate + Fan							6			-
	Autotransf. +Policarbonate + Fan							7			-
Regulator	Standard							0			-
	computer SMART III 6								S		-
	computer SMART III 12								T		-
	computer PLUS 8T - CDI(*)								E		-
	computer PLUS 14T - CDI(*)								F		-
Switch	without switch								0		-
	Manual switch 200 A								3		-
	Manual switch 250A								4		-
	Manual switch 400 A								5		-
	Manual switch 630 A								6		-
	Manual switch 800 A								7		-
	Manual switch 1000 A								8		-
	Manual switch 1600 A								9		-
	Automatic switch 63 A								A		-
	Automatic switch 125 A								B		-
	Automatic switch 160 A / 200 A								C		-
	Automatic switch 250A								D		-
	Automatic switch 400 A								E		-
	Automatic switch 630 A								F		-
	Automatic switch 800 A								G		-
	Automatic switch 1000 A								H		-
	Automatic switch 1250 A								I		-
	Automatic switch 1600 A								J		-
	Automatic switch 63 A + Earth leakage								K		-
	Automatic switch 125 A + Earth leakage								L		-
	Automatic switch 160 A + Earth leakage								M		-
	Automatic switch 250 A + Earth leakage								N		-
	Automatic switch 400 A + Earth leakage								O		-
	Automatic switch 630 A + Earth leakage								P		-
Automatic switch 800 A + Earth leakage								Q		-	
Automatic switch 1000 A + Earth leakage								R		-	
Automatic switch 1250 A + Earth leakage								S		-	
Automatic switch 1600 A + Earth leakage								T		-	

(*) With communications, earth leakage current and capacitor current

computer MAX Plug&Play

Series

Choose the regulator that is most suited to your needs

Performance, accuracy and technology at the best price

- Simple and intuitive installation and programming
- Test functions
- High-accuracy regulation
- Basic electrical parameter measurement
- Built-in alarms



computer *smart* III

Optional

**All-in-one three-phase regulator and analyzer
A new concept in compensation**

- Measures and compensates over three phases,
- Carries out the functions of a powerful power analyzer.
- Easy to use
- Serial communications
- built-in leakage control system
- Plug & Play
- AUTO-ON-OFF function
- Safety and maintenance

Table: Selection of automatic capacitor banks with a static contactor

	OPTIM EMS-C	OPTIM EMK
		
Rated voltage	440 V	440 V
Power range at rated voltage (50 Hz)	18,75...120 kvar	OPTIM EMK4: 175...400 kvar OPTIM EMK6: 400...600 kvar OPTIM EMK8: 600...800 kvar OPTIM EMK10: 850...1000 kvar OPTIM EMK12: 1050...1200 kvar
Thyristor operation	•	•
No. Steps (maximum)	8	4 / 6 / 8 / 10/ 12
Enclosure	Metallic IP 21	•
Installation (indoor)	•	•
Assembly	Wall-mounted Floor-mounted	- •
Regulator	computer Max Fast computer Smart III Fast	• Optional
Capacitor	Cilindric CLZ	•
Built-in protection	General circuit breaker APR NH-00 Fuse	- •

OPTIM EMS, Automatic capacitor banks with static contactor

Type	Code	400 V kvar	440 V kvar	Composition	Man.Switch (A)	Cable section (mm ²)	Size (mm) width xheight xdepth	weight (kg)
OPTIM EMS-C-18,75-440	[C] R4A300.	15.5	18.75	(6,25 + 12,5)	Included	1 x 6	545x710x220	29,00
OPTIM EMS-C-31,25-440	[C] R4A304.	26	31.25	(6,25 + 2 x 12,5)	Included	1 x 16	545x710x220	33,00
OPTIM EMS-C-43,75-440	[C] R4A309.	36	43.75	(6,25 + 12,5 + 25)	Included	1 x 25	545x710x220	34,00
OPTIM EMS-C-68,75-440	[C] R4A318.	57	68.75	(6,25 + 12,5 + 2 x 25)	Included	1 x 50	545x710x220	38,00
OPTIM EMS-C-82,50-440	[C] R4A321.	68	82.5	(7,5 + 15 + 2 x 30)	Included	1 x 70	545x710x220	39,00
OPTIM EMS-C-105-440	[C] R4A330.	87	105	(15 + 3 x 30)	Included	1 x 70	545x710x220	40,00
OPTIM EMS-C-120-440	[C] R4A336.	99	120	(4 x 30)	Included	1 x 95	545x710x220	41,00

Switch and cable cross-section recommended for installations with Un= 400 V. Installers must confirm that this meets everything established in the Low Voltage Directive according to the special characteristics of each installation and cable type, completely relieving CIRCUTOR S.A. of all breaches of the pertinent regulations as a result of an incorrect choice of the type and cross-section of the cabling.



NEW

OPTIM EMK, Automatic capacitor banks with static contactor

Type	Code	400 V kvar	440 V kvar	Composition	Aut.Switch (A)	Man. Switch (A)	Cable section (mm ²)	Size (mm) width x height x depth	weight (kg)
OPTIM EMK4-175-440	[2] R46420.	175	147	25 + 50 + 100	400	400	400	900x1900x650	170,00
OPTIM EMK4-250-440	[2] R46422.	250	207	50 + 2x100	630	630	630	900x1900x650	183,00
OPTIM EMK4-300-440	[2] R46424.	300	248	50 + 50 + 2x100	630	630	630	900x1900x650	208,00
OPTIM EMK4-350-440	[2] R46425.	350	289	50 + 3x100	630	630	630	900x1900x650	217,00
OPTIM EMK4-400-440	[2] R46426.	400	331	4x100	800	800	800	900x1900x650	231,00
OPTIM EMK6-400-440	[2] R46431.	400	331	50 + 50 + 3x100	800	800	800	1200x1900x650	262,00
OPTIM EMK6-450-440	[2] R46435.	450	372	50 + 4x100	800	800	800	1200x1900x650	281,00
OPTIM EMK6-550-440	[2] R46437.	550	455	50 + 5x100	1000	1000	1000	1200x1900x650	320,00
OPTIM EMK6-600-440	[2] R46438.	600	496	6x100	1250	1600	1250	1200x1900x650	334,00
OPTIM EMK8-600-440	[2] R46442.	600	496	50 + 50 + 5x100	1250	1600	1250	1500x1900x650	365,00
OPTIM EMK8-650-440	[2] R46444.	650	537	50 + 6x100	1250	1600	1250	1500x1900x650	384,00
OPTIM EMK8-750-440	[2] R46450.	750	620	50 + 7x100	1600	1600	1600	1500x1900x650	359,00
OPTIM EMK8-800-440	[2] R46455.	800	661	8x100	1600	1600	1600	1500x1900x650	373,00
OPTIM EMK10-850-440	[2] R46505.	850	702	50 + 8x100	1250+250	1600+250	1250/250	2100x1900x650	512,00
OPTIM EMK10-950-440	[2] R46604.	950	785	50 + 9x100	1250+400	1600+400	1250/400	2100x1900x650	551,00
OPTIM EMK10-1000-440	[2] R46605.	1000	826	10x100	1600+400	1600+400	1600/400	2100x1900x650	565,00
OPTIM EMK12-1050-440	[2] R46606.	1050	868	50 + 10x100	1250+800	1600+800	1250/800	2400x1900x650	615,00
OPTIM EMK12-1150-440	[2] R46608.	1150	950	50 + 11x100	2x1250	2x1600	2x1250	2400x1900x650	654,00
OPTIM EMK12-1200-440	[2] R46609.	1200	992	12x100	2x1250	2x1600	2x1250	2400x1900x650	668,00

Switch and cable cross-section for installations with Un= 400 V. The installation company must ensure compliance with the low voltage directive at all times, in accordance with the particularities of each installation and type of cable.

Table: Selection of Static automatic capacitor banks with rejection filters

	OPTIM FRES	OPTIM FRE
		
Rated voltage	440 V	440 V
Service voltage	400 V	400 V
Power range at rated voltage (50 Hz)	31,25 a 120 kvar	OPTIM FRE4: 150 ... 400 kvar OPTIM FRE6: 400 ... 600 kvar OPTIM FRE8: 600 ... 800 kvar OPTIM FRE10: 800 ... 1000 kvar OPTIM FRE12: 1050 ... 1200 kvar
Thyristor operation	•	•
No. Steps (maximum)	4	4 / 6 / 8 / 10 / 12
Enclosure	Metallic IP 21	•
Installation (indoor)	•	•
Assembly (floor-mounted)	•	•
Regulator	Computer Max F-12DC	•
	Computer Smart Fast III-12DC	Optional
Capacitor	Cilindrico CLZ	•
Reactors tuned to 189 Hz (please ask about other tuning values)	•	•
Built-in protection	General circuit breaker	–
	APR NH-00 Fuses	•

OPTIM FRE, Automatic capacitor banks with rejection filters (static contactor)

Optional installation of a mains switch, f resonance =189 Hz

Type	Code	400 V kvar	440 V kvar	Composition	Aut.Switch (A)	Man. Switch (A)	Cable section (mm ²)	Size (mm) width xheight xdepth	weight (kg)
FRES									
OPTIM FRES-31,25-440	[2] R64R64.	26	31.25	6,25 + 2 x 12,5	-	Included	10	800x1200x500	102,00
OPTIM FRES-43,75-440	[2] R64R74.	36	43.75	6,25 + 12,5 + 25	-	Included	25	800x1200x500	108,00
OPTIM FRES-62,5-440	[2] R64R81.	52	62.5	12,5 + 2 x 25	-	Included	35	800x1200x500	115,00
OPTIM FRES-90-440	[2] R64R88.	74	90	2 x 15 + 2 x 30	-	Included	70	800x1200x500	133,00
OPTIM FRES-105-440	[2] R64R92.	87	105	15 + 3 x 30	-	Included	70	800x1200x500	138,00
OPTIM FRES-120-440	[2] R64R95.	99	120	4 x 30	-	Included	95	800x1200x500	143,00
FRE4									
OPTIM FRE4-150-440	[2] R64E24.	125	150	30 + 2 x 60	400	400	95	900x1900x650	220,00
OPTIM FRE4-175-440	[2] R64E25.	145	175	25 + 50 + 100	400	400	120	900x1900x650	225,00
OPTIM FRE4-200-440	[2] R64E28.	165	200	50 + 50 + 100	400	400	150	900x1900x650	235,00
OPTIM FRE4-250-440	[2] R64E29.	207	250	50 + 2 x 100	630	630	185	900x1900x650	250,00
OPTIM FRE4-300-440	[2] R64E30.	248	300	50 + 50 + 2 x 100	630	630	240	900x1900x650	290,00
OPTIM FRE4-350-440	[2] R64E32.	289	350	50 + 3 x 100	630	630	240	900x1900x650	310,00
OPTIM FRE4-400-440	[2] R64E34.	331	400	4 x 100	800	800	240	900x1900x650	335,00
FRE6									
OPTIM FRE6-400-440	[2] R64J25.	331	400	50 + 50 + 3 x 100	800	800	2x185	1200x1900x650	370,00
OPTIM FRE6-450-440	[2] R64J30.	372	450	50 + 4 x 100	800	800	2x185	1200x1900x650	400,00
OPTIM FRE6-500-440	[2] R64J35.	413	500	5 x 100	1000	1000	2x240	1200x1900x650	440,00
OPTIM FRE6-550-440	[2] R64J40.	455	550	50 + 5 x 100	1000	1000	2x240	1200x1900x650	465,00
OPTIM FRE6-600-440	[2] R64J45.	496	600	6 x 100	1250	1600	2x240	1200x1900x650	490,00
FRE8									
OPTIM FRE8-600-440	[2] R64K36.	496	600	50 + 50 + 5 x 100	1250	1600	2x240	1500x1900x650	525,00
OPTIM FRE8-650-440	[2] R64K38.	537	650	50 + 6 x 100	1600	1600	3x150	1500x1900x650	540,00
OPTIM FRE8-700-440	[2] R64K40.	579	700	7 x 100	1600	1600	3x150	1500x1900x650	555,00
OPTIM FRE8-750-440	[2] R64K42.	620	750	50 + 7 x 100	1600	1600	3x185	1500x1900x650	580,00
OPTIM FRE8-800-440	[2] R64K44.	661	800	8 x 100	1600	1600	3x185	1500x1900x650	605,00
FRE10									
OPTIM FRE10-800-440	[2] R64C25.	661	800	8 x 100	1250+400	1600+400	2x240 / 240	2100x1900x650	695,00
OPTIM FRE10-850-440	[2] R64C30.	702	850	50 + 8 x 100	1000+630	1000+630	2x240 / 240	2100x1900x650	735,00
OPTIM FRE10-900-440	[2] R64C35.	744	900	9 x 100	1250+630	1600+630	2x240 / 240	2100x1900x650	775,00
OPTIM FRE10-950-440	[2] R64C40.	785	950	50 + 9 x 100	1000+800	1000+800	2x240 / 2x185	2100x1900x650	800,00
OPTIM FRE10-1000-440	[2] R64C45.	826	1000	10 x 100	1250+800	1600+800	2x240 / 2x185	2100x1900x650	825,00
OPTIM FRE12-1050-440	[2] R64L50.	868	1050	50 + 10 x 100	1250+800	1600+800	2x240 / 2x240	2400x1900x650	890,00
OPTIM FRE12-1100-440	[2] R64L55.	909	1100	11 x 100	1250+1000	1600+1000	2x240 / 2x240	2400x1900x650	930,00
OPTIM FRE12-1150-440	[2] R64L60.	950	1150	50 + 11 x 100	2x1250	2x1600	2x240 / 2x240	2400x1900x650	955,00
OPTIM FRE12-1200-440	[2] R64L65.	992	1200	12 x 100	2x1250	2x1600	2x240 / 2x240	2400x1900x650	980,00

Switch and cable cross-section for installations with Un= 400 V. The installation company must ensure compliance with the low voltage directive at all times, in accordance with the particularities of each installation and type of cable.



<p>Choose the regulator that is most suited to your needs</p>	<p>computer MAX-F (Series) for EMK computer MAX-F 12 VDC (Series) for OPTIM EMS-C & OPTIM FRES / FRE</p>	<p>computer SMART FAST III 12 VDC (Optional) for OPTIM FRES / FRE</p>
	<p>Performance, accuracy and technology at the best price</p> <ul style="list-style-type: none"> > Simple and intuitive installation and programming > Test functions > High-accuracy regulation > Basic electrical parameter measurement > Built-in alarms 	<p>Regulation, measurement and protection within your reach</p> <ul style="list-style-type: none"> > Built-in power analyzer > Plug & Play > Serial communications > AUTO-ON-OFF function > Open programming > Built-in leakage control > Safety and maintenance

CODIFICATION TABLE

OPTIM EMK, OPTIM FRE

Code		Internal Code								
R	X	X	X	X	0	0	X	X	X	
										Delivery time
Options										-
										-
										-
										-
Choose the most suitable regulator for your needs										-
										-
										-
										-
Switch										-
										-
										-
										-
										-
										-
										-
										-
										-
										-
										-
										-
										-
										-
										-
										-
										-
										-

⁽¹⁾ Only in EMK series. With communications, earth leakage current and capacitor current Accessories not available for EMS-C series

Dimensions

OPTIM 1

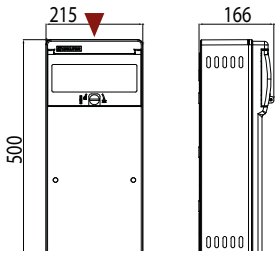

OPTIM 1A

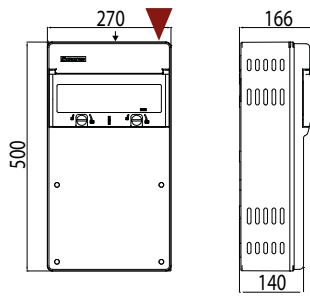

OPTIM 2

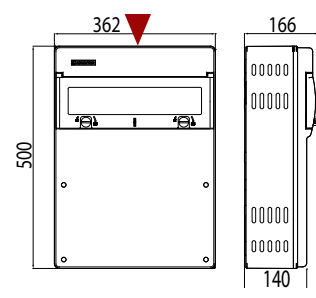

OPTIM 3 P&P

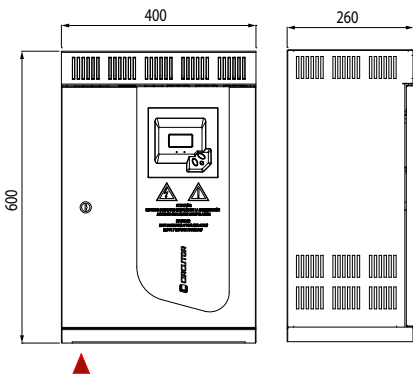

OPTIM 5 P&P

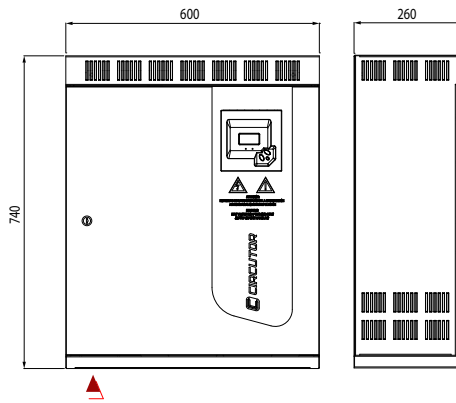

OPTIM 9 P&P

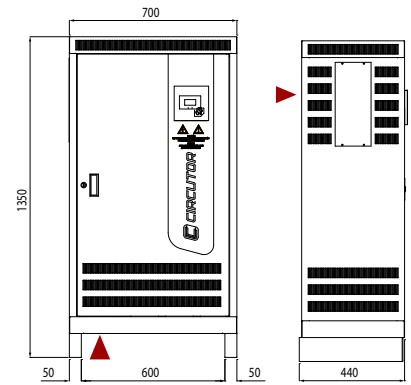

OPTIM 8

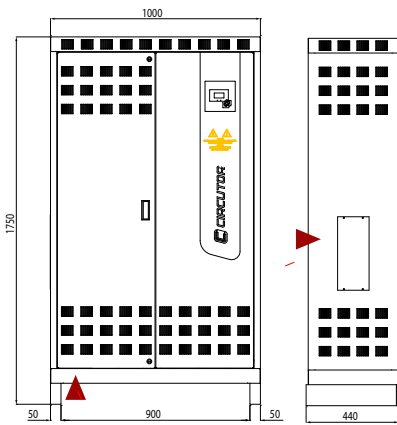

OPTIM 8L

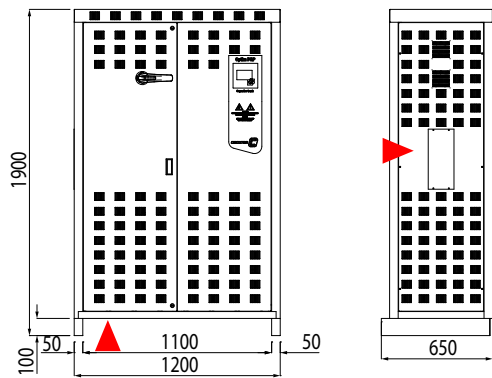

OPTIM 14L

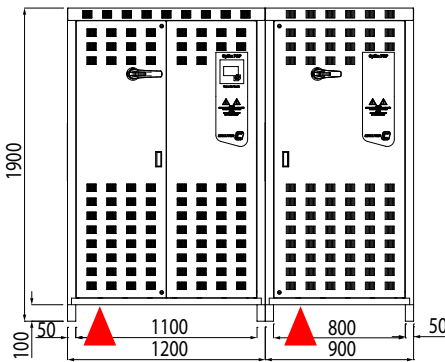

OPTIM 16L

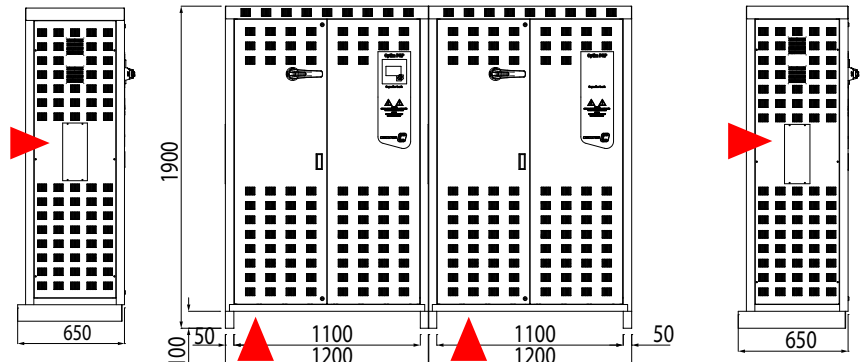

▲ Entrada cable

Dimensions

OPTIM FRS

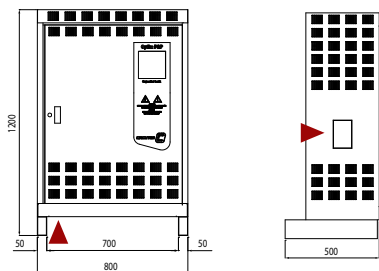

OPTIM EMK₄ / OPTIM FR₄ / OPTIM FRE₄

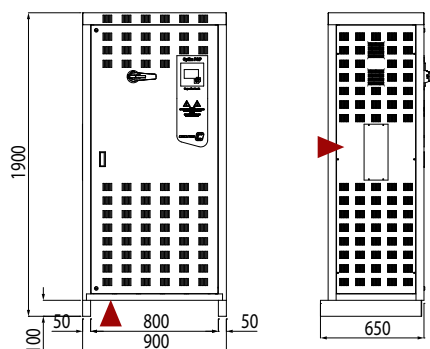

OPTIM EMK₆ / OPTIM FR₆ / OPTIM FRE₆

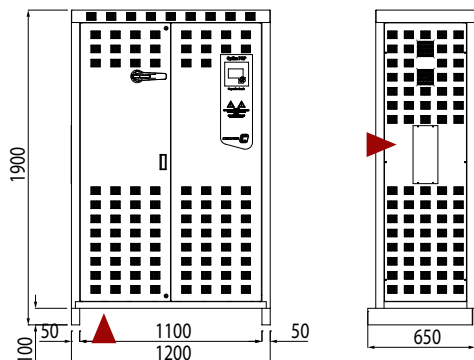

OPTIM EMK₈ / OPTIM FR₈ / OPTIM FRE₈

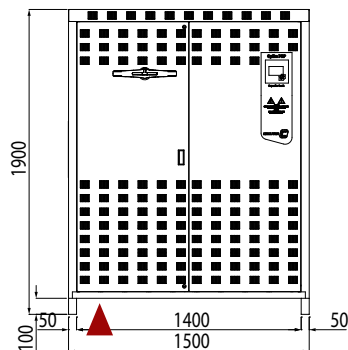

FRF / FRM

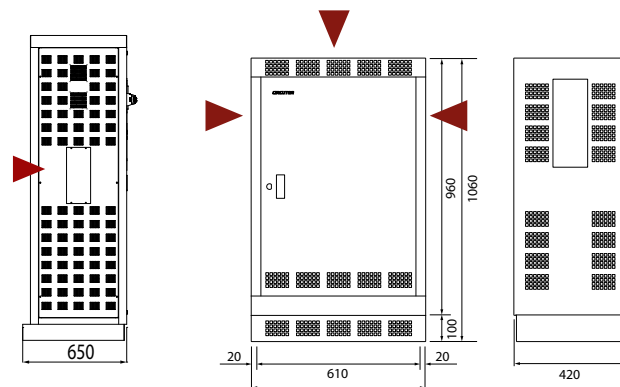

▲ Entrada cable

OPTIM EMK₁₀ / OPTIM FR₁₀ / OPTIM FRE₁₀

OPTIM FR10 = OPTIM FR4 + OPTIM FR6. / Ancho: OPTIM FR4+ OPTIM FR6+100 mm

OPTIM EMK₁₂ / OPTIM FR₁₂ / OPTIM FRE₁₂

OPTIM FR12 = 2 x OPTIM FR6. / Ancho= 2 x OPTIM FR6+100 mm

EMB / EMF

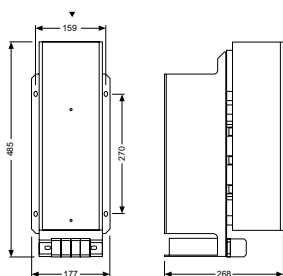

EMB-2PH

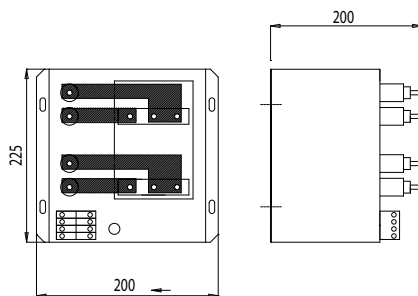

Dimensions

Optim EMS-C

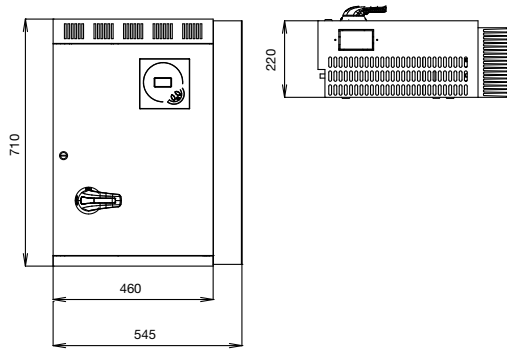

OPTIM HYB 1

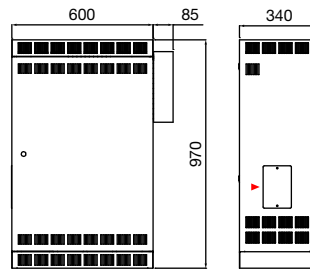

OPTIM HYB 2

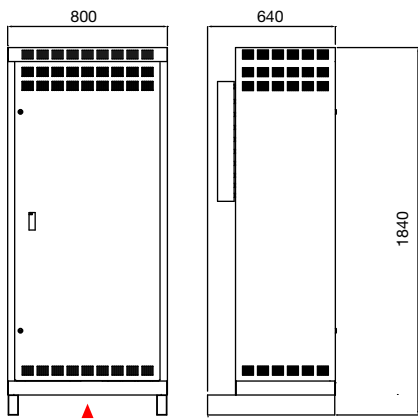

OPTIM HYB 3

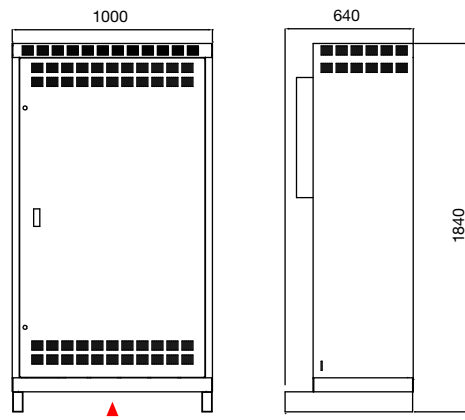

Entrada cable

▲ Entrada cable



Harmonic filters

NEW

AFQevo, Active multifunction filter

50/60 Hz - Harmonic filtering, phase balancing and power factor correction



Type	Code	System	Phase current	Peak current	Max. neutral current	EMI filter	Size (mm) width xheight xdepth	weight (kg)
Wall-mounted cabinet								
AFQe-3WS-030M-480	[C] R7LM7B.	3 wires, 480 V	30	60	0	-	435x600x257	31,00
AFQe-3WF-030M-480	[C] R7LM73.	3 wires, 480 V	30	60	0	1	435x710x257	32,00
AFQe-4WS-030M-400	[C] R7QM0B.	4 wires, 400 V	30	60	90	-	435x600x257	31,00
AFQe-4WF-030M-400	[C] R7QM03.	4 wires, 400 V	30	60	90	1	435x708x257	32,00
Floor-mounted cabinet								
AFQe-3WF-100C-480	[C] R7LF75.	3 wires, 480 V	100	200	0	1	600x1836x822	206,00
AFQe-3WF-200C-480	[C] R7LF77.	3 wires, 480 V	200	400	0	1	600x1836x822	276,00
AFQe-4WF-100A-400	[C] R7QF05.	4 wires, 400 V	100	200	300	1	600x1836x822	206,00
AFQe-4WF-200A-400	[C] R7QF07.	4 wires, 400 V	200	400	600	1	600x1836x822	276,00
Rack module								
AFQe - 3WS - 100R - 480	[C] R7LR7D.	3 wires, 480 V	100	200	0	-	260x480x500	70,00
AFQe - 4WS - 100R - 400	[C] R7QR0D.	4 wires, 400 V	100	200	300	-	260x480x500	70,00

Please contact our technical department for networks with high THD(V) levels



LR, Filter reactors for power converters (network side)

Type	Code	In (A)	Motor P. (kW)	Motor P. (CV)	L(mH)	Losses	Size (mm) width xheight xdepth	weight (kg)
LR 04-003	[2] P70301.	2,5	0.75	1	14.8	6	120x125x60	1,80
LR 04-004	[2] P70302.	4	1.5	2	7.9	8	120x125x60	1,80
LR 04-006	[2] P70303.	5,5	2.2	3	5.9	10	120x125x60	2,00
LR 04-008	[2] P70304.	7,5	3	4	4.3	12	120x125x60	2,00
LR 04-010	[2] P70305.	10	4	5	3.2	15	120x125x70	2,30
LR 04-013	[2] P70306.	13	5.5	7	2.5	18	120x125x70	2,30
LR 04-017	[2] P70307.	17	7.5	10	1.85	25	150x150x75	3,50
LR 04-022	[2] P70308.	22	11	15	1.47	30	150x152x90	4,60
LR 04-033	[2] P70309.	32	15	20	0.98	45	150x152x90	5,00
LR 04-050	[2] P7030B.	47	22	30	0.67	64	180x197x110	9,00
LR 04-066	[2] P7030D.	64	30	41	0.49	88	180x197x120	11,00
LRB 04-080	[2] P7030E.	76	37	50	0.4	110	180x160x135	13,00
LRB 04-115	[2] P7030G.	110	55	75	0.28	145	237x195x131	21,00
LRB 04-185	[C] P7030J.	180	90	122	0.17	230	242x256x154	32,00
LRB 04-200	[C] P7030K.	200	110	150	0.15	245	245x256x154	36,00
LRB 04-300	[C] P7030M.	300	160	220	0.1	355	280x300x164	48,00

LR, LRB

Code	Internal code	Delivery time
P 7 X X X X 0 0 X X X		
Code	Standard (4 %)	0
Voltage drop	3 %	1
	2 %	2
Frequency	Estandard (50 Hz)	0
	60 Hz	1
System	Standard (three-phase)	0
	Single-phase	1

Delivery time: [*] immediate
 [x] working weeks
 [c] consult

SINUS, Filter for PWM

Sinus filter without enclosure (IP00), 400 V

Type	Code	In (A)	Switching Frequency (kHz)	Size (mm) width xheight xdepth
SINUS-10A-400-IP00	[4] R7S002.	10	10	191x180x120
SINUS-25-40-00	[4] R7S004.	25	10	244x301x248
SINUS-80-40-00	[4] R7S006.	80	10	290x422x360
SINUS-155-40-00	[4] R7S008.	155	10	390x503x360
SINUS-270-40-00	[4] R7S00A.	270	2	415x557x360

LCL, Harmonic filters for power converters

Type	Code	Q (kvar)	Load current	Frequency (Hz)	Size (mm) width xheight xdepth
400 V					
LC L35-9A-400	[4] R73105.	1,76	9	50	365x570x217
LC L35-12A-400	[4] R73106.	2,51	12	50	365x570x217
LC L35-16A-400	[4] R73107.	3,27	16	50	365x570x217
LC L35-22A-400	[4] R73108.	4,42	22	50	460x930x230
LC L35-32A-400	[4] R73109.	6,63	32	50	460x930x230
LC L35-40A-400	[4] R73110.	8,29	40	50	460x930x230
LC L35-47A-400	[4] R73111.	9,14	47	50	650x1060x420
LC L35-54A-400	[4] R73112.	10,8	54	50	650x1060x420
LC L35-64A-400	[4] R73113.	13,26	64	50	650x1060x420
LC L35-76A-400	[4] R73114.	14,92	76	50	650x1060x420
LC L35-90A-400	[4] R73115.	18,24	90	50	800x1900x650
LC L35-110A-400	[4] R73116.	23,21	110	50	800x1900x650
LC L35-150A-400	[4] R73117.	29,84	150	50	800x1900x650
LC L35-180A-400	[4] R73118.	36,48	180	50	800x1900x650
LC L35-220A-400	[4] R73119.	46,42	220	50	800x1900x650
LC L35-260A-400	[4] R73120.	53,06	260	50	800x1900x650
LC L35-320A-400	[4] R73121.	66,32	320	50	1100x1900x650
LC L35-400A-400	[4] R73122.	79,58	400	50	1100x1900x650
460 - 480 V					
LC L36-9A-480	[4] R732050070000	2,73	9	60	365x570x217
LC L36-16A-480	[4] R732070070000	4,55	16	60	365x570x217
LC L36-22A-480	[4] R732080070000	6,21	22	60	460x930x230
LC L36-32A-480	[4] R732090070000	7,59	32	60	460x930x230
LC L36-40A-480	[4] R732100070000	11,38	40	60	460x930x230
LC L36-47A-480	[4] R732110070000	15,18	47	60	650x1060x420
LC L36-54A-480	[4] R732120070000	15,18	54	60	650x1060x420
LC L36-64A-480	[4] R732130070000	18,97	64	60	650x1060x420
LC L36-76A-480	[4] R732140070000	22,77	76	60	650x1060x420
LC L36-90A-480	[4] R732150070000	26,56	90	60	800x1900x650
LC L36-110A-480	[4] R732160070000	30,36	110	60	800x1900x650
LC L36-150A-480	[4] R732170070000	45,53	150	60	800x1900x650
LC L36-180A-480	[4] R732180070000	53,12	180	60	800x1900x650
LC L36-220A-480	[4] R732190070000	60,71	220	60	800x1900x650
LC L36-260A-480	[4] R732200070000	68,3	260	60	800x1900x650
LC L36-320A-480	[4] R732210070000	91,07	320	60	1100x1900x650
LC L36-400A-480	[4] R732220070000	121,42	400	60	1100x1900x650

Please contact us for other current, frequency and/or voltage values Optional: Overcompensation kit

LCL-TH, Filter for elevators

Type	Code	Q (kvar)	Load current	Frequency (Hz)	Size (mm) width xheight xdepth
400 - 415 V					
LCL-TH 35-7A-400	[4] R7K104.	1,76	7	50	365x570x217
LCL-TH 35-9A-400	[4] R7K105.	1,51	9	50	365x570x217
LCL-TH 35-12A-400	[4] R7K106.	2,51	12	50	365x570x217
LCL-TH 35-16A-400	[4] R7K107.	3,27	16	50	532x930x235
LCL-TH 35-22A-400	[4] R7K108.	4,42	22	50	532x930x235

 Delivery time: [*] immediate
 [x] working weeks
 [c] consult



FB3, Third harmonic blocking filter for 50 Hz network

Type	Code	System	Max.neutral current	Frequency (Hz)	Size (mm) width xheight xdepth	weight (kg)
Single-phase						
FB3-5-06	[*] R78101.	Single-phase	6	50	204x310x233	8,00
Without box (IP 00)						
FB3T-5-06-00	[4] R78131.	Three-phase	6	50	300x200x200	-
FB3T-5-10-00	[4] R78132.	Three-phase	10	50	300x200x200	-
FB3T-5-16-00	[4] R78133.	Three-phase	16	50	300x200x200	-
FB3T-5-25-00	[4] R78134.	Three-phase	25	50	370x280x300	-
FB3T-5-32-00	[4] R78135.	Three-phase	32	50	370x280x300	-
FB3T-5-50-00	[4] R78136.	Three-phase	50	50	370x280x300	-
FB3T-5-63-00	[4] R78137.	Three-phase	63	50	370x420x370	-
FB3T-5-100-00	[4] R78138.	Three-phase	100	50	370x420x370	-
With box (IP 21)						
FB3T-5-6-21	[C] R78121.	Three-phase	6	50	300x200x200	-
FB3T-5-10-21	[C] R78122.	Three-phase	10	50	300x200x200	-
FB3T-5-16-21	[C] R78123.	Three-phase	16	50	300x200x200	-
FB3T-5-25-21	[C] R78124.	Three-phase	25	50	300x200x200	-
FB3T-5-32-21	[C] R78125.	Three-phase	32	50	370x280x300	-
FB3T-5-50-21	[C] R78126.	Three-phase	50	50	370x280x300	-
FB3T-5-63-21	[C] R78127.	Three-phase	63	50	370x420x370	-
FB3T-5-100-21	[C] R78128.	Three-phase	100	50	370x420x370	-



FAR-Q, Hybrid absorption filters

Type	Code	Q (kvar)	Composition	In (A)	Size (mm) width xheight xdepth	weight (kg)
FAR5-Q6 400 V / 50 Hz						
FAR5-Q6-112,5-400	[C] R7C101.	112,5	3 x 37,5	176	1100x1900x650	436,00
FAR5-Q6-187,5-400	[C] R7C103.	187,5	5 x 37,5	293	1100x1900x650	460,00
FAR5-Q6-262,5-400	[C] R7C105.	262,5	37,5 + (3 x 75)	410	1100x1900x650	460,00
FAR5-Q6-337,5-400	[C] R7C107.	337,5	37,5 + (4 x 75)	527	1100x1900x650	523,00
FAR5-Q6-375-400	[C] R7C108.	375	5 x 75	586	1100x1900x650	550,00
FAR5-Q8 400 V / 50 Hz						
FAR5-Q8-412,5-400	[C] R7C109.	412,5	37,5 + (5 x 75)	644	1500x1900x650	687,00
FAR5-Q8-525-400	[C] R7C112.	525	7 x 75	820	1500x1900x650	740,00
FAR5-Q12 400 V / 50 Hz						
FAR5-Q12-562,5-400	[C] R7C113.	562,5	37,5 + (7 x 75)	878	2200x1900x650	950,00
FAR5-Q12-637,5-400	[C] R7C115.	637,5	37,5 + (8 x 75)	996	2200x1900x650	1.009,00
FAR5-Q12-712,5-400	[C] R7C117.	712,5	37,5 + (9 x 75)	1113	2200x1900x650	1.073,00
FAR5-Q12-750-400	[C] R7C118.	750	10 x 75	1171	2200x1900x650	1.100,00

Maximum current in the installation

FB3

FB3T

TYPE	A	B	C
FB3T-16	300	200	200
FB3T-50	370	280	300
FB3T-100	370	480	370

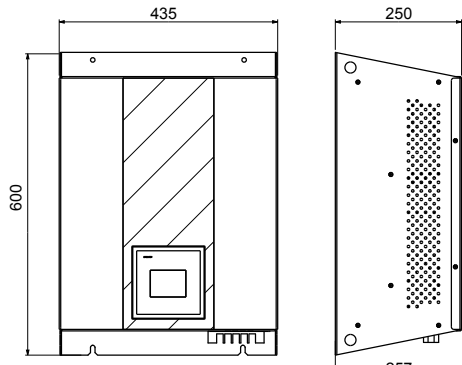
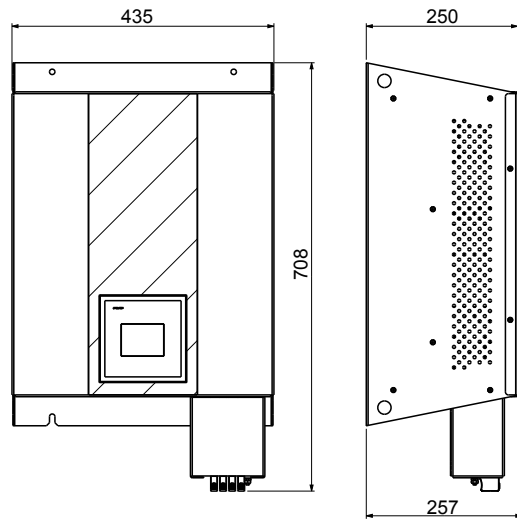
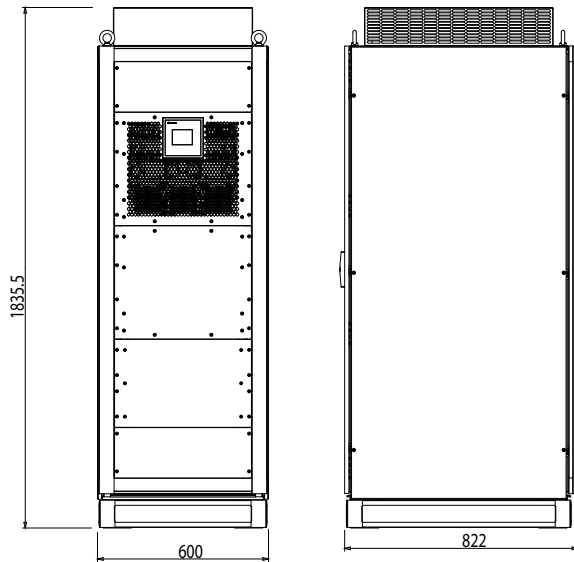
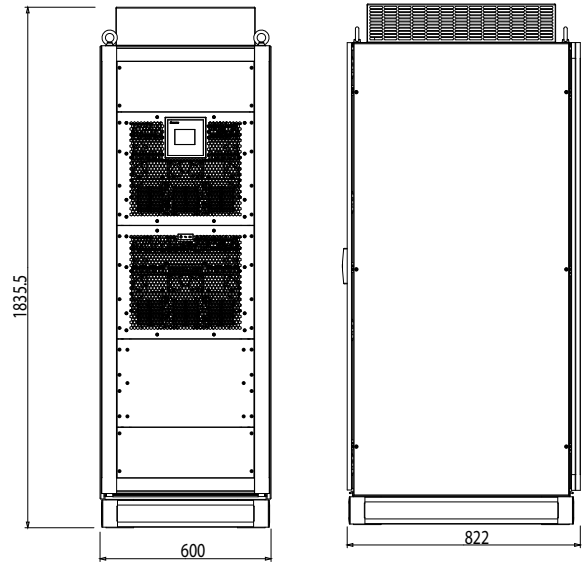
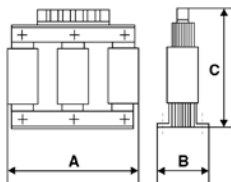
Dimensions
AFQe-4WS

AFQe-4WF

AFQe-100

AFQe-200

LR / LRB

Tipo	A mm	B mm	C mm	kg
LR 04-003	120	60	125	1,8
LR 04-004	120	60	125	1,8
LR 04-006	120	60	125	2
LR 04-008	120	60	125	2
LR 04-010	120	70	125	2,3
LR 04-013	120	70	125	2,3
LR 04-017	150	75	150	3,5
LR 04-022	150	90	152	4,6
LR 04-033	150	90	152	5
LR 04-041	180	100	193	7,5
LR 04-050	180	110	197	9
LR 04-058	180	110	197	9,5
LR 04-066	180	120	197	11

Tipo	A mm	B mm	C mm	kg
LRB 04-080	180	135	160	13
LRB 04-095	237	120	195	18
LRB 04-115	237	131	195	21
LRB 04-150	237	131	215	26
LRB 04-185	242	154	256	32
LRB 04-200	245	154	256	36
LRB 04-250	285	154	300	44
LRB 04-300	280	164	300	48

Capacitor and MV accessories



The prices for medium-voltage capacitors are valid for orders for a minimum of 4 units of each type.

Price supplement for orders with 3 or fewer units (by type): +10%

The prices that appear in the price list correspond to capacitors with indoor/outdoor installation, with internal fuses (according to type) and frequency of 50 Hz.



CHV-M, Single-phase MV power capacitors (indoor and outdoor use)

Type	Code	Q (kvar)	Frequency (Hz)	Size (mm) width xheight xdepth	weight (kg)
BIL 20/60 kV (50 Hz) - 3,81 kV					
CHV-M 50/3,81	[C] R8A0500003810	50	50	350x487x160	18,20
CHV-M 75/3,81	[C] R8A0750003810	75	50	350x487x160	18,50
CHV-M 100/3,81	[C] R8A1000003810	100	50	350x537x160	21,90
CHV-M 150/3,81	[C] R8A1500003810	150	50	350x637x160	29,10
CHV-M 167/3,81	[C] R8A1670003810	167	50	350x637x160	29,30
CHV-M 200/3,81	[C] R8A2000003810	200	50	350x697x160	33,50
CHV-M 250/3,81	[C] R8A2500003810	250	50	350x867x160	44,80
CHV-M 300/3,81	[C] R8A3000003810	300	50	350x867x160	45,80
CHV-M 333/3,81	[C] R8A3330003810	333	50	350x957x160	52,30
CHV-M 400/3,81	[C] R8A4000003810	400	50	350x927x175	55,30
CHV-M 500/3,81	[C] R8A5000003810	500	50	350x1097x175	68,30
CHV-M 600/3,81	[C] R8A6000003810	600	50	350x1247x175	80,20
BIL 28/75 kV (50 Hz) - 6,35 kV					
CHV-M 50/6,35	[C] R8B0500006350	50	50	350x487x160	17,90
CHV-M 75/6,35	[C] R8B0750006350	75	50	350x537x160	21,80
CHV-M 100/6,35	[C] R8B1000006350	100	50	350x537x160	21,80
CHV-M 150/6,35	[C] R8B1500006350	150	50	350x637x160	28,60
CHV-M 167/6,35	[C] R8B1670006350	167	50	350x637x160	29,10
CHV-M 200/6,35	[C] R8B2000006350	200	50	350x697x160	33,20
CHV-M 250/6,35	[C] R8B2500006350	250	50	350x757x160	37,80
CHV-M 300/6,35	[C] R8B3000006350	300	50	350x867x160	45,30
CHV-M 333/6,35	[C] R8B3330006350	333	50	350x857x175	49,40
CHV-M 400/6,35	[C] R8B4000006350	400	50	350x927x175	54,50
CHV-M 500/6,35	[C] R8B5000006350	500	50	350x1067x175	65,60
CHV-M 600/6,35	[C] R8B6000006350	600	50	350x1247x175	79,20
CHV-M 750/6,35	[C] R8B7500006350	750	50	350x1217x200	90,40
BIL 38/95 kV (50 Hz) - 9,53 kV					
CHV-M 50/9,53	[C] R8C0500009530	50	50	350x530x160	19,50
CHV-M 75/9,53	[C] R8C0750009530	75	50	350x530x160	20,20
CHV-M 100/9,53	[C] R8C1000009530	100	50	350x580x160	23,60
CHV-M 150/9,53	[C] R8C1500009530	150	50	350x680x160	31,00
CHV-M 167/9,53	[C] R8C1670009530	167	50	350x740x160	34,90
CHV-M 200/9,53	[C] R8C2000009530	200	50	350x740x160	35,40
CHV-M 250/9,53	[C] R8C2500009530	250	50	350x910x160	46,90
CHV-M 300/9,53	[C] R8C3000009530	300	50	350x910x160	48,00
CHV-M 333/9,53	[C] R8C3330009530	333	50	350x1000x160	54,70
CHV-M 400/9,53	[C] R8C4000009530	400	50	350x1000x175	59,70
CHV-M 500/9,53	[C] R8C5000009530	500	50	350x1140x175	71,00
CHV-M 600/9,53	[C] R8C6000009530	600	50	350x1290x175	83,10
CHV-M 750/9,53	[C] R8C7500009530	750	50	350x1257x200	90,40
BIL 50/125 kV (50 Hz) - 12,7 kV					
CHV-M 50/12,7	[C] R8D0500012700	50	50	350x615x160	19,70
CHV-M 75/12,7	[C] R8D0750012700	75	50	350x665x160	23,40
CHV-M 100/12,7	[C] R8D1000012700	100	50	350x715x160	26,80
CHV-M 150/12,7	[C] R8D1500012700	150	50	350x765x160	31,20
CHV-M 167/12,7	[C] R8D1670012700	167	50	350x825x160	35,10
CHV-M 200/12,7	[C] R8D2000012700	200	50	350x885x160	39,20
CHV-M 250/12,7	[C] R8D2500012700	250	50	350x995x160	47,00
CHV-M 300/12,7	[C] R8D3000012700	300	50	350x995x160	48,10
CHV-M 333/12,7	[C] R8D3330012700	333	50	350x1055x175	56,90
CHV-M 400/12,7	[C] R8D4000012700	400	50	350x1085x175	59,60
CHV-M 500/12,7	[C] R8D5000012700	500	50	350x1225x175	70,90
CHV-M 600/12,7	[C] R8D6000012700	600	50	350x1375x175	83,00
CHV-M 750/12,7	[C] R8D7500012700	750	50	350x1405x200	98,80



The prices for medium-voltage capacitors are valid for orders for a minimum of 4 units of each type.

Price supplement for orders with 3 or fewer units (by type): **+10%**

The prices that appear in the price list correspond to capacitors with indoor/outdoor installation, with internal fuses (according to type) and frequency of 50 Hz.

Type	Code	Q (kvar)	Frequency (Hz)	Size (mm) width xheight xdepth	weight (kg)
BIL 70/170 kV (50 Hz) - 19,05 kV					
CHV-M 50/19,05	[C] R8E0500019050	50	50	350x644x160	23,30
CHV-M 75/19,05	[C] R8E0750019050	75	50	350x644x160	23,60
CHV-M 100/19,05	[C] R8E1000019050	100	50	350x694x160	27,00
CHV-M 150/19,05	[C] R8E1500019050	150	50	350x804x160	35,00
CHV-M 167/19,05	[C] R8E1670019050	167	50	350x804x160	35,30
CHV-M 200/19,05	[C] R8E2000019050	200	50	350x864x160	39,40
CHV-M 250/19,05	[C] R8E2500019050	250	50	350x964x175	50,80
CHV-M 300/19,05	[C] R8E3000019050	300	50	350x1034x175	56,50
CHV-M 333/19,05	[C] R8E3330019050	333	50	350x1034x175	57,10
CHV-M 400/19,05	[C] R8E4000019050	400	50	350x1134x175	64,40
CHV-M 500/19,05	[C] R8E5000019050	500	50	350x1244x175	73,70
CHV-M 600/19,05	[C] R8E6000019050	600	50	350x1264x200	84,10
CHV-M 750/19,05	[C] R8E7500019050	750	50	350x1454x200	104,20

CHV-T, Three-phase MV power capacitors

Type	Code	Q (kvar)	Frequency (Hz)	Size (mm) width xheight xdepth	weight (kg)
BIL 20/60 kV (50 Hz) - 3,3 kV					
CHV-T 50/3,3	[C] R8K0500003300	50	50	350x422x160	18,80
CHV-T 75/3,3	[C] R8K0750003300	75	50	350x472x160	22,40
CHV-T 100/3,3	[C] R8K1000003300	100	50	350x472x160	22,80
CHV-T 150/3,3	[C] R8K1500003300	150	50	350x572x160	30,00
CHV-T 200/3,3	[C] R8K2000003300	200	50	350x632x160	34,40
CHV-T 250/3,3	[C] R8K2500003300	250	50	350x802x160	45,70
CHV-T 300/3,3	[C] R8K3000003300	300	50	350x802x160	46,70
CHV-T 333/3,3	[C] R8K3330003300	333	50	350x862x175	55,60
CHV-T 400/3,3	[C] R8K4000003300	400	50	350x892x175	58,30
CHV-T 500/3,3	[C] R8K5000003300	500	50	350x1032x175	69,40
CHV-T 600/3,3	[C] R8K6000003300	600	50	350x1182x175	81,20
CHV-T 750/3,3	[C] R8K7500003300	750	50	350x1252x200	97,30
BIL 20/60 kV (50 Hz) - 6,6 kV					
CHV-T 50/6,6	[C] R8K0500006600	50	50	350x422x160	19,20
CHV-T 75/6,6	[C] R8K0750006600	75	50	350x472x160	22,60
CHV-T 100/6,6	[C] R8K1000006600	100	50	350x472x160	23,00
CHV-T 150/6,6	[C] R8K1500006600	150	50	350x572x160	30,20
CHV-T 200/6,6	[C] R8K2000006600	200	50	350x692x160	38,30
CHV-T 250/6,6	[C] R8K2500006600	250	50	350x802x160	45,90
CHV-T 300/6,6	[C] R8K3000006600	300	50	350x802x160	46,90
CHV-T 333/6,6	[C] R8K3330006600	333	50	350x862x175	55,90
CHV-T 400/6,6	[C] R8K4000006600	400	50	350x892x175	58,60
CHV-T 500/6,6	[C] R8K5000006600	500	50	350x1032x175	69,70
CHV-T 600/6,6	[C] R8K6000006600	600	50	350x1182x175	81,20
CHV-T 750/6,6	[C] R8K7500006600	750	50	350x1252x200	97,60
BIL 28/75 kV (50 Hz) - 11 kV					
CHV-T 50/11	[C] R8L0500011000	50	50	350x422x160	19,30
CHV-T 75/11	[C] R8L0750011000	75	50	350x472x160	22,70
CHV-T 100/11	[C] R8L1000011000	100	50	350x472x160	23,00
CHV-T 150/11	[C] R8L1500011000	150	50	350x572x160	30,10
CHV-T 200/11	[C] R8L2000011000	200	50	350x632x160	34,40
CHV-T 250/11	[C] R8L2500011000	250	50	350x802x160	45,70
CHV-T 300/11	[C] R8L3000011000	300	50	350x802x160	46,50
CHV-T 333/11	[C] R8L3330011000	333	50	350x892x175	53,00
CHV-T 400/11	[C] R8L4000011000	400	50	350x862x175	56,10
CHV-T 500/11	[C] R8L5000011000	500	50	350x1002x175	67,00
CHV-T 600/11	[C] R8L6000011000	600	50	350x1182x175	80,70
CHV-T 750/11	[C] R8L7500011000	750	50	350x1192x200	92,10

LVC, Three-phase contactor for MV capacitors

400 A - 6.6 kV AC



Type	Code	Max. voltage	Max. Current (A)	auxiliary voltage
VC-6Z44ED 6,6kV 220V	[*] R80921.	6,6 kVca	3 x 400	220 Vac
VC-6Z44ED 6,6kV 110V	[*] R809210010000	6,6 kVca	3 x 400	110 Vdc

RMV, Choke reactors for MV capacitor banks



Type	Code	In (A)	L(mH)	Size (mm) width xheight xdepth	weight (kg)
RMV-260					
RMV-260-50-350	[2] R80628.	50	350	370x290x110	13,00
RMV-260-60-250	[2] R80637.	60	250	370x290x110	14,00
RMV-260-100-100	[*] R80664.	100	100	370x290x110	16,00
RMV-260-125-50	[2] R80672.	125	50	370x290x110	14,00
RMV-260-175-30	[2] R80691.	175	30	370x290x110	14,00
RMV-330					
RMV-330-60-450	[2] R80739.	60	450	470x355x110	20,00
RMV-330-75-350	[2] R80748.	75	350	470x355x110	21,00
RMV-330-90-250	[2] R80757.	90	250	470x355x110	26,00
RMV-330-125-100	[2] R80774.	125	100	470x355x110	22,00
RMV-330-200-50	[2] R807A2.	200	50	470x355x110	22,00
RMV-330-250-30	[2] R807B1.	250	30	470x355x110	23,00

Dimensions

CHV-M

CHV-T

RMV

Tipo	A Ø mm	B Ø mm	C mm	D mm	E mm	F mm	Insertos
RMV-260	260	130	370	160	370	290	M12
RMV-330	330	150	470	190	355	210	M12/M16

MV Automatic capacitor banks

CIRKAP. Easy to choose complete products

Selection of capacitor banks

CIRKAP capacitor banks are divided in two main groups: Capacitor banks in a **CM** frame and capacitor banks in open **BM** frames.

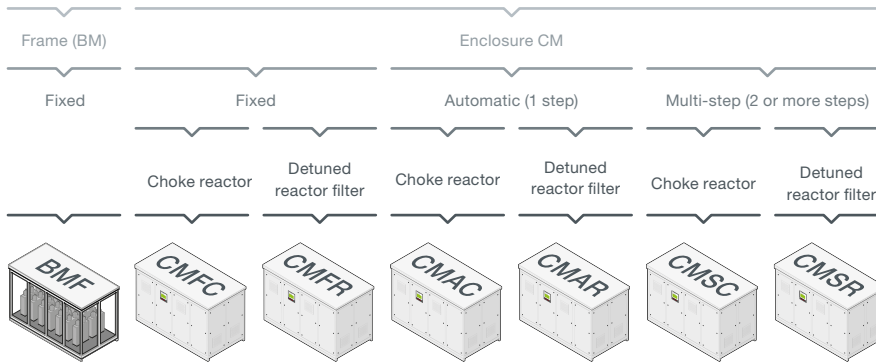

References for CIRKAP BM

Code											
B	M	X	X	X	X	X	X	X	X	X	X
		↑	↑	↑	↑	↑	↑	↑	↑	↑	↑
Fixed (step 1)	F										
Without choke reactor	-										
With choke reactor	C										
Number of steps (1)			n°								
Rated voltage (3 figures) 3.3 kV											033
Rated voltage (3 figures) 4.2 kV											042
Rated voltage (3 figures) 5.5 kV											055
Rated voltage (3 figures) 6.0 kV											060
Rated voltage (3 figures) 6.3 kV											063
Rated voltage (3 figures) 6.6 kV											066
Rated voltage (3 figures) 11 kV											110
Rated voltage (3 figures) 13.2 kV											132
Rated voltage (3 figures) 15 kV											150
Rated voltage (3 figures) 16.5 kV											165
Rated voltage (3 figures) 22 kV											220
Rated voltage (3 figures) 33 kV											330
Nominal capacitor bank power in kvar (5 figures)											n°

References for CIRKAP CM

Code											
C	M	X	X	X	X	X	X	X	X	X	X
		↑	↑	↑	↑	↑	↑	↑	↑	↑	↑
Fixed (step 1)	F										
Automatic (1 step)	A										
Multistep	S										
Without choke reactor	-										
With choke reactor	C										
With detuned filter	R										
Number of steps (1...9)				n°							
Rated voltage (3 figures) 3.3 kV											033
Rated voltage (3 figures) 4.2 kV											042
Rated voltage (3 figures) 5.5 kV											055
Rated voltage (3 figures) 6.0 kV											060
Rated voltage (3 figures) 6.3 kV											063
Rated voltage (3 figures) 6.6 kV											066
Rated voltage (3 figures) 11 kV											110
Rated voltage (3 figures) 13.2 kV											132
Rated voltage (3 figures) 15 kV											150
Rated voltage (3 figures) 16.5 kV											165
Rated voltage (3 figures) 22 kV											220
Rated voltage (3 figures) 33 kV											330
Nominal capacitor bank power in kvar (5 figures)											n°

Application examples



Water treatment installation

Automatic multi-step capacitor bank with detuned filter, model **CMSR**, 2250 kvar at 6,6 kV, 50 Hz, 5x650 kvar composition, tuned to 189 Hz (p:7%), outdoor installation and IP44 protection degree. Details of the step with fuse protection, vacuum contactor, filtering reactor and three-phase capacitor.



Paper industry

Automatic multi-step capacitor bank with detuned filter, model **CMSR**, 6750 kvar at 22 kV, 50 Hz, 750+4x1500 kvar composition, tuned to 189 Hz (p:7%), outdoor installation and IP54 protection degree. Voltage presence indicator, ON/OFF step, manual or automatic step selection, reactive energy regulator with three-phase measurement and overcurrent, short-circuit and step offset protection relays.



Road infrastructures

Automatic multi-step capacitor banks with detuned filter, model **CMAR**, 100 kvar at 3.3 kV, 50 Hz, 1x100 kvar composition, indoor installation and IP23 protection degree, tuned to 189 Hz. Details of the structure adapted to the space available in the tunnel and corporate colour requested by the client.

Additional components of MV capacitor banks



Pressure switch

Disconnects the step/capacitor bank with the pressure generated after a serious fault inside a capacitor, in order to prevent greater damage. It enables the power circuit to be disconnected and signals the fault when the pressure reaches the maximum value.



Voltage presence indicator

A unit that lights up permanently when the power circuit is powered to provide greater safety during operations carried out on the unit.



Smoke detector

Smoke detectors are devices that warn about the possibility of internal combustion in the capacitor bank and that send a signal to activate an alarm (in the unit or at the discretion of the user), disconnecting the of the battery if necessary.



Electric circuit with opening delay for doors

For units that are ordered with doors in the power modules, Circutor offers the possibility of including a solenoid electrical interlock system in order to prevent access to the capacitor bank's interior if the necessary time has not elapsed.



SVacuum off-load and/or earthing switch

The cut-off and/or earthing switch enables the unit to be visually disconnected and isolated at the capacitor bank input.



Ventilation

In the case of capacitor banks installed in environmental conditions where natural convection cooling is insufficient, an auxiliary thermostat-controlled forced air system is essential for evacuating the internal heat of the capacitor bank.



Anti-condensation heating resistors

These are used to avoid condensation due to temperature gradients during the day, under saline environmental conditions, high relative humidity and low temperatures. Heating resistors controlled by thermostat and/or hygrometer.

Step dimensions

Power	7,2 kV	12 kV	24 kV	36 kV
≤250 kvar	A	A	B	C
21-500 kvar	A	A	B	C
501-750 kvar	A	B	B	C
751-1000 kvar	A, B	B	B	C
1001-1500 kvar	B	B	C	C
1501-2000 kvar	B	B	C	C
201-2500 kvar	B	B	C	C
2501-3000 kvar	B	C	C	C
3001-4000 kvar	C	C	C	C
4001-5000 kvar	C	C	C	
5001-6000 kvar	C	C	C	
6001-7000 kvar	C	C	C	

Dimensions are approximate and may differ depending on the specifications for each team.

INDOOR

OUTDOOR

A

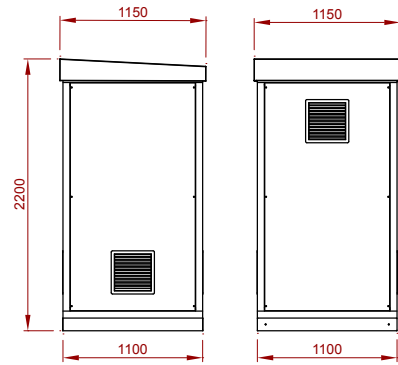
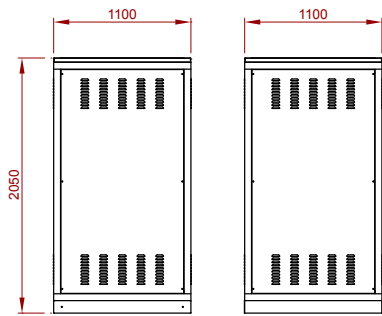

B

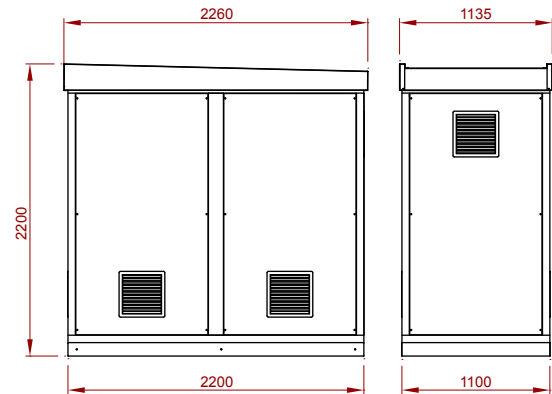
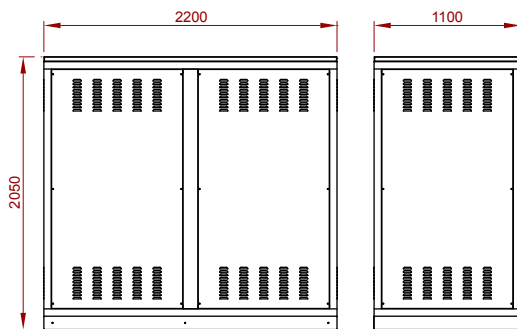

C

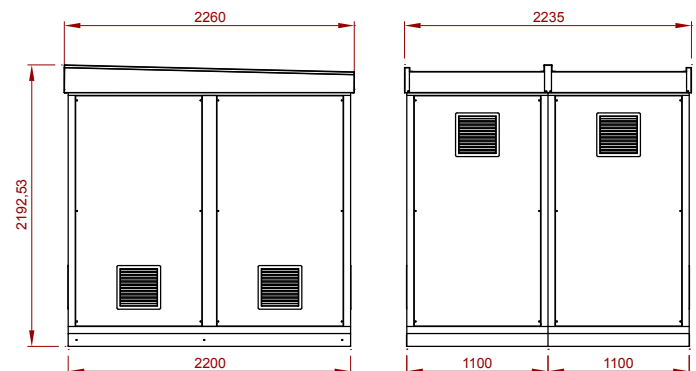
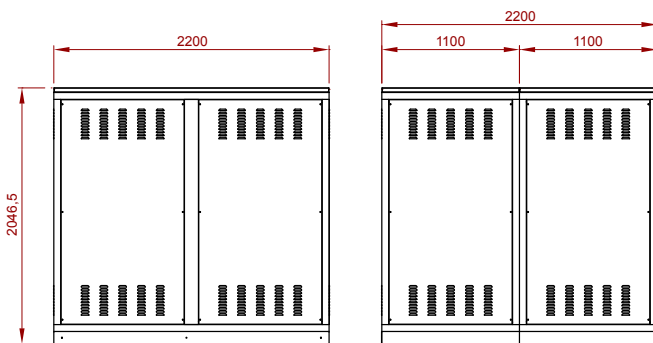



Smart electric vehicle charging

Smart electric vehicle charging

Charging modes	155
Connector type	155





Outdoor charging station

URBAN, Outdoor slow charging posts - mode 1, 2 and 3	156
RAPTION 22, Compact fast charging stations, mode 3 and 4	156
RAPTION 50, Compact fast charging stations, mode 3 and 4	156



Car park boxes indoor

eHome, Car park boxes, mode 3	157
RVE-WB, Car park boxes.....	157
WB-eBasic, Car park boxes, mode 3.....	157
CirBEON, Sensor for dynamic control of charging power.....	158
COFRET, Protection box for single-phase charging points.....	158
PD, Pedestal for RVE-WB and eHome.....	158
CONNEX, Other accessories.....	158
RVE-CARD, Prepayment system.....	158



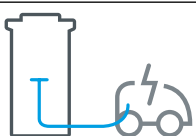

PRODUCTOS DESTACADOS

	URBAN	RAPTION 22 / 50	RVE-WB	eHome	CirBEON
					
	Outdoor post	Fast charging Station	Smart car park box	Domestic car park box	Sensor for dynamic control
page	156	156	157	157	158

Charging modes

MODE 1	MODE 2	MODE 3	MODE 4
			
Direct vehicle-to-grid connection. > Non-dedicated socket. > Single cable. > Overheating risk. > Suitable for small and 2-wheel EV	Direct vehicle-to-grid connection. > Non-dedicated socket. > Cable with communication device and monitoring of charging. > Suitable for small EV up to 2.8 kW	Direct vehicle-to-grid connection. > Dedicated socket with monitoring of charging. > Dedicated cable. > Charging 3.7...22 kW	Indirect vehicle-to-grid connection through an external charger. > External direct current socket with monitoring of charging. > Dedicated cable. > Quick charging 22...50 kW

Connector type

CA	Type 1		CC	JEVS G105 / CHAdeMO	
	Type 2			CCS Combo 2	



Outdoor charging station



NEW

URBAN, Outdoor slow charging posts - mode 1, 2 and 3

Type	Code	No. Sockets	Output type	Connector type	Network type	Communications
URBAN 10						
URBAN M11	[C] V10610.	1	230 V - 32 A - 7,4 kW	Type 2 socket	Single-phase	-
URBAN T11	[C] V10611.	1	400 V - 32 A - 22 kW	Type 2 socket	Three-phase	-
URBAN M12	[C] V10612.	2	230 V - 32 A - 7,4 kW	Type 2 socket	Single-phase	-
URBAN T12	[C] V10613.	2	400 V - 32 A - 22 kW	Type 2 socket	Three-phase	-
URBAN T14-MIX	[C] V10617.	4 (2)	400 V - 32 A - 22 kW; 230 V - 16 A - 3,6 kW	Type 2 socket Schuko	Three-phase	-
URBAN 20						
URBAN M21	[C] V10620.	1	230 V - 32 A - 7,4 kW	Type 2 socket	Single-phase	Ethernet
URBAN T21	[C] V10621.	1	400 V - 32 A - 22 kW	Type 2 socket	Three-phase	Ethernet
URBAN M22	[C] V10622.	2	230 V - 32 A - 7,4 kW	Type 2 socket	Single-phase	Ethernet
URBAN T22	[C] V10623.	2	400 V - 32 A - 22 kW	Type 2 socket	Three-phase	Ethernet
URBAN M22-C1	[C] V10625.	2	230 V - 32 A - 7,4 kW	Cable Type 1	Single-phase	Ethernet
URBAN T22-C2	[C] V10626.	2	400 V - 32 A - 22 kW	Type 2 cable	Three-phase	Ethernet
URBAN T24-MIX	[C] V10627.	4 (2)	400 V - 32 A - 22 kW; 230 V - 16 A - 3,6 kW	Type 2 socket; Schuko	Three-phase	Ethernet

Type A circuit breaker and earth leakage protection, independent on each connection, LED indicator of the state of charge. Aluminium and ABS plastic casing (IP 54 / IK 10). Dimensions: 446 x 1544 x 234 mm For 3G communications, see the code table



NEW

RAPTION 22, Compact fast charging stations, mode 3 and 4

Type	Code	No. Sockets	Output type	Connector type	Network type	Communications
RAPTION 22 CCS	[8] V17010.	1	50-550 Vcc - 56 A - 22 kW	CCS Combo 2	Three-phase	Ethernet + 3G
RAPTION 22 CHA	[8] V17015.	1	50-550 Vcc - 56 A - 22 kW	JEVS G105 - CHAdeMO	Three-phase	Ethernet + 3G
RAPTION 22 DUO	[8] V17020.	2	50-550 Vcc - 56 A - 22 kW	JEVS G105 - CHAdeMO CCS Combo2	Three-phase	Ethernet + 3G
RAPTION 22 TRIO	[8] V17030.	3	50-550 Vcc - 56 A - 22 kW 400 Vca - 32 A - 22 kW	CCS Combo 2; JEVS G105 - CHAdeMO Type 2 socket	Three-phase	Ethernet + 3G

Built-in energy measurement system, RFID reader, vandal-proof 8" TFT touchscreen, Ethernet and 3G and data storage connection, OCPP & XML, communication protocol, C-curve circuit breaker protection, resettable Type A 30 mA earth leakage protection, galvanised steel and stainless steel enclosure - IP54 - IK10, dimensions: 900 x 1710 x 310 mm



NEW

RAPTION 50, Compact fast charging stations, mode 3 and 4

Type	Code	No. Sockets	Output type	Connector type	Communications
RAPTION 50 CCS	[8] V17110.	1	50-500 Vcc - 125 A - 50 kW	CCS Combo 2	Ethernet + 3G
RAPTION 50 CHA	[8] V17115.	1	50-500 Vcc - 125 A - 50 kW	JEVS G105 - CHAdeMO	Ethernet + 3G
RAPTION 50 DUO	[8] V17120.	2	50-500 Vcc - 125 A - 50 kW	CCS Combo 2 JEVS G105 - CHAdeMO	Ethernet + 3G
RAPTION 50 TRIO	[8] V17130.	3	50-500 Vcc - 125 A - 50 kW 400 Vca - 32 A - 22 kW	CCS Combo 2 JEVS G105 - CHAdeMO; Type 2 socket	Ethernet + 3G
RAPTION 50 TRIO 63	[8] V17131.	3	50-500 Vcc - 125 A - 50 kW 400 Vca - 63 A - 43 kW	CCS Combo 2 JEVS G105 - CHAdeMO Type 2 cable	Ethernet + 3G

Built-in energy measurement system, RFID reader, vandal-proof 8" TFT touchscreen, Ethernet and 3G and data storage connection, OCPP & XML, communication protocol, C-curve circuit breaker protection, resettable Type A 30 mA earth leakage protection, galvanised steel and stainless steel enclosure - IP54 - IK10, dimensions: 940 x 1710 x 520 mm

CODIFICATION TABLE

URBAN20						
Code	Internal code					
V	1	X	X	X	0	X
					0	0
						↑ Delivery time
Additional communications	-				0	-
	+ 3G				1	1

Delivery time: [*] immediate
[x] working weeks
[c] consult



Car park boxes indoor



eHome, Car park boxes, mode 3

Type	Code	No. Sockets	Output type	Connector type	Key	Earth leakage protection	circuit breaker protection	MID meter	Charge mode
eHome T2C16	[3] V25020.	1	230 V - 16 A - 3,6 kW	Type 2 cable	-	-	-	-	3
eHome T2C32	[3] V25030.	1	230 V - 32 A - 7,4 kW	Type 2 cable	-	-	-	-	3
eHome T1C16	[3] V25000.	1	230 V - 16 A - 3,6 kW	Type 1 cable	-	-	-	-	3
eHome T1C32	[3] V25010.	1	230 V - 32 A - 7,4 kW	Type 1 cable	-	-	-	-	3
eHome T2C32-A	[3] V25031.	1	230 V - 32 A - 7,4 kW	Type 2 cable	1	Type A	-	-	3
eHome T2C32-A MID	[3] V25032.	1	230 V - 32 A - 7,4 kW	Type 2 cable	1	Type A	-	MID	3
eHome T2C32-B	[3] V25033.	1	230 V - 32 A - 7,4 kW	Type 2 cable	1	Type B	-	-	3
eHome T2C32-AM	[3] V25034.	1	230 V - 32 A - 7,4 kW	Type 2 cable	1	Type A	40A	-	3
eHome T1C32-A	[3] V25011.	1	230 V - 32 A - 7,4 kW	Type 1 cable	1	Type A	-	-	3
eHome T1C32-A MID	[3] V25012.	1	230 V - 32 A - 7,4 kW	Type 1 cable	1	Type A	-	MID	3
eHome T1C32-B	[3] V25013.	1	230 V - 32 A - 7,4 kW	Type 1 cable	1	Type B	-	-	3
eHome T1C32-AM	[3] V25014.	1	230 V - 32 A - 7,4 kW	Type 1 cable	1	Type A	40A	-	3

Please check the CirBEON unit in the accessories section for the dynamic power control functions. Cable support included



RVE-WB, Car park boxes

Type	Code	No. Sockets	Output type	Connector type	Charge mode	Keyboard	Communications
RVE-WBM-SMART	[3] V23015.	1	230 V - 32 A - 7,4 kW	Type 2 socket	3	-	Ethernet
RVE-WBM-SMART-TRI	[3] V23025.	1	400 V - 32 A - 22 kW	Type 2 socket	3	-	Ethernet
RVE-WBMC-SMART	[3] V23032.	1	230 V - 32 A - 7,4 kW	Type 2 cable	3	-	Ethernet
RVE-WBMC-SMART-TRI	[3] V23035.	1	400 V - 32 A - 22 kW	Type 2 cable	3	-	Ethernet
RVE-WB2M-SMART	[3] V23500.	2	230 V - 32 A - 7,4 kW	Type 2 socket	3	-	Ethernet
RVE-WB2M-SMART-TRI	[3] V23530.	2	400 V - 32 A - 22 kW	Type 2 socket	3	-	Ethernet
RVE-WBM-TOUCH-TRI	[3] V23045.	1	400 V - 32 A - 22 kW	Type 2 cable	3	*	Ethernet
RVE-WBMC-TOUCH-TRI	[3] V23050.	1	400 V - 32 A - 22 kW	Type 2 cable	3	*	Ethernet
RVE-WBC-SMART	[3] V23115.	1	230 V - 16 A - 3,6 kW	Type 1 cable	3	-	Ethernet
RVE-WBC-SMART-32	[3] V23116.	1	230 V - 32 A - 7,4 kW	Type 1 cable	3	-	Ethernet
RVE-WBCS-SMART	[3] V23121.	2	230 V - 32 A - 7,4 kW 230 V - 16 A - 3,6 kW	Type 1 cable Schuko	1, 2, 3	-	Ethernet
RVE-WBC-TOUCH	[3] V23125.	1	230 V - 16 A - 3,6 kW	Type 1 cable	3	*	Ethernet
RVE-WBC-TOUCH-32	[3] V23126.	1	230 V - 32 A - 7,4 kW	Type 1 cable	3	*	Ethernet
RVE-WBS-SMART	[3] V23215.	1	230 V - 16 A - 3,6 kW	Schuko	1, 2	-	Ethernet
RVE-WB-MIX-SMART	[3] V23315.	2	230 V - 32 A - 7,4 kW; 230 V - 16 A - 3,6 kW	Type 2 socket Shuko	1, 2, 3	-	Ethernet
RVE-WB-MIX-SMART-TRI	[3] V23325.	2	400 V - 32 A - 22 kW; 230 V - 16 A - 3,6 kW	Type 2 socket Shuko	1, 2, 3	-	Ethernet

Built-in energy measurement system, RFID reader, two-line LCD display, internal measurement, LED indicator of the state of charge, OCPP & XML communication protocol. (*1) Support for 4 m cable and direct type 2 connector, car side, according to IEC 61196-2 (*2) Support for 5 m cable and direct type 1 SAE J-1772 connector, car side, according to IEC 61196-2 Please check the encoding table for 3G communications



WB-eBasic, Car park boxes

Type	Code	No. Sockets	Output type	Connector type	Key	Earth leakage protection	Charge mode
WB-eBasic T2C32	[3] V26030.	1	400 V - 32 A - 22 kW	Type 2 cable	-	-	3
WB-eBasic T2S32	[3] V26040.	1	400 V - 32 A - 22 kW	Type 2 socket	-	-	3
WB-eBasic T2S32 A	[3] V26041.	1	230 V - 32 A - 7,4 kW	Type 2 socket	1	Type A	3
WB-eBasic MIX	[3] V26050.	2	400 V - 32 A - 22 kW; 230 V - 32 A - 3,6 kW	Type 2 socket Schuko	-	-	1, 2, 3

Self-extinguishing ABS plastic box, IP 54-IK 10. Dimensions: 320x225x130 mm. Compatible with the CirBEON power manager. (*1) Cable support included Type 2 casings can be powered and have a single or three-phase output. If they are powered with a single-phase power supply, they will have a single-phase output. Similarly, if they are powered with a three-phase power supply, they will have a three phase output

CODIFICATION TABLE

RVE-WB							
V	2	X	X	X	X	0	0
							X
Code						Internal code	Delivery time
Additional communications						-	0
+ 3G							1

Delivery time: [*] immediate
[x] working weeks
[c] consult

**NEW****CirBEON, Sensor for dynamic control of charging power**

Type	Code	Contracted power (kW)
CirBEON-20	[*] V42002.	4.6
CirBEON-25	[*] V42003.	5.75
CirBEON-30	[*] V42004.	6.9
CirBEON-35	[*] V42005.	8.05
CirBEON-40	[*] V42006.	9.2
CirBEON-50	[*] V42008.	11.5
CirBEON-63	[*] V42009.	14.49

Compatible with units of the eHome and WB-eBasic series Maximum distance to the charging unit of 200 m. Polyester encapsulation, IP 20. Dimensions: 30x15 mm

COFRET, Protection box for charging points

Type	Code	Earth leakage protection	MID meter	Surge Protection (SPD)	circuit breaker protection	Size (mm) width x height x depth	weight (kg)
2 poles							
COFRET-VE6-2P-20A	[3] V41231.	30 mA, Type A	-	-	20 A	170x200x115	1,00
COFRET-VE6-2P-20AS	[3] V41232.	30 mA, Type A	-	1	20 A	170x200x115	1,00
COFRET-VE8-2P-20A MID	[3] V41233.	30 mA, Type A	MID	-	20 A	215x200x115	1,00
COFRET-VE6-2P-40A	[3] V41261.	30 mA, Type A	-	-	40 A	170x200x115	1,00
COFRET-VE6-2P-40AS	[3] V41262.	30 mA, Type A	-	1	40 A	170x200x115	1,00
COFRET-VE8-2P-40A MID	[3] V41263.	30 mA, Type A	MID	-	40 A	215x200x115	1,00
4 poles							
COFRET-VE12-4P-40A	[3] V41461.	30 mA, Type A	-	-	40 A	270x250x160	-
COFRET-VE12-4P-40AS	[3] V41462.	30 mA, Type A	-	1	40 A	270x250x160	-
COFRET-VE12-4P-40A MID	[3] V41463.	30 mA, Type A	MID	-	40 A	270x250x160	-

Electrical protection elements, in compliance with the ITC-BT-52 Standard, C-curve circuit breaker protection, Class A 30 mA earth leakage protection, polycarbonate and polystyrene enclosure, IP 65 - IK10

**PD, Pedestal for RVE-WB and eHome**

Type	Code	Description	Device
PD-WB1	[3] V40321.	Aluminium pedestal 5754, dimensions 1500 x 344 x 273 mm	1 x WBM
PD-WBC1	[3] V40323.	Aluminium pedestal 5754, dimensions 1500 x 344 x 273 mm	1 x (WBC / WBMC)
PD-WB2	[3] V40322.	Aluminium pedestal 5754, dimensions 1500 x 542 x 288 mm	2 x WBM
PD10-WM	[3] V40310.	Aluminium pedestal 5754, dimensions 1500 x 344 x 273 mm	1 x eHOME
PD10-FM1	[3] V40311.	Aluminium pedestal 5754, dimensions 1500 x 344 x 273 mm	1 x eHOME
PD10-FM2	[3] V40312.	Aluminium pedestal 5754, dimensions 1500 x 542 x 288 mm	2 x eHOME

CONNEX, Other accessories

Type	Code	Description
CONNEX T1-T2	[*] V40125.	Type 1 to Type 2 adaptor charging cable, Full compatibility with Mode 3 IEC 61851-1, Connector Type 1- SAE J1772 on the side of the vehicle, Connector Type 2 on the side of the charger, maximum permissible current of 32 A, length of 5 m
CONNEX T2-T2	[*] V40126.	Type 2 charging cable, Full compatibility with Mode 3 IEC 61851-1, Connector Type 2 on the side of the charger, maximum permissible current of 32 A, length of 5 m

RVE-CARD, Prepayment system

Type	Code	Description
RVE-CARD	[3] V30012.	Proximity card.

Delivery time: [*] immediate
[x] working weeks
[c] consult



Dimensions

URBAN

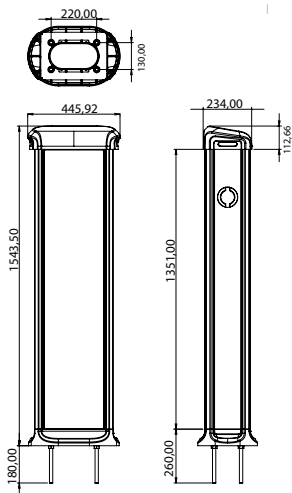

eHome

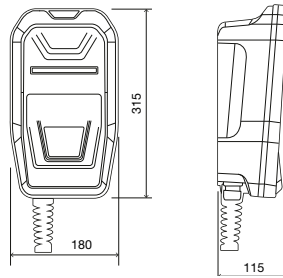

RVE-WB / WB-eBasic

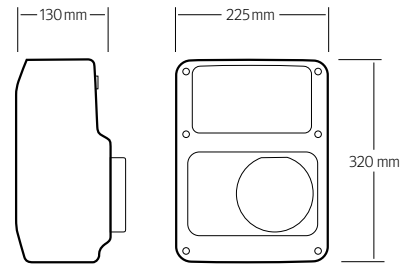

RAPTION 22

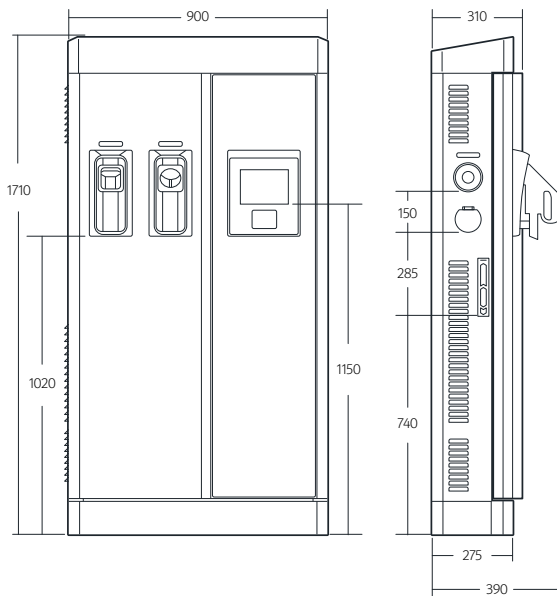

RAPTION 50

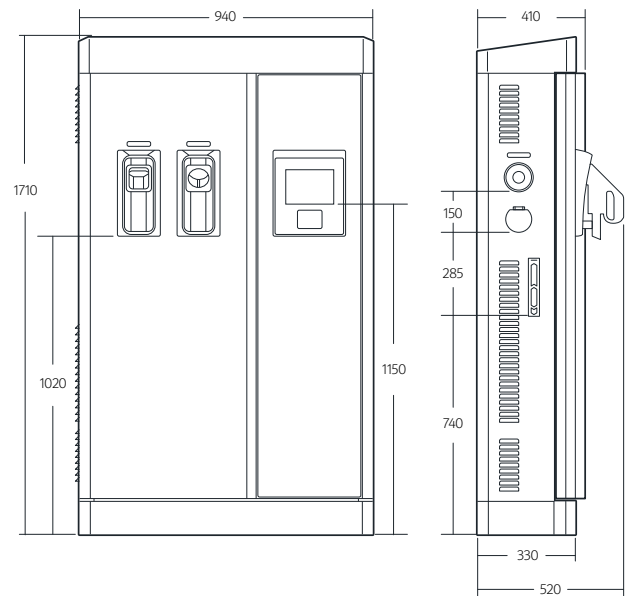

COFRET-2P

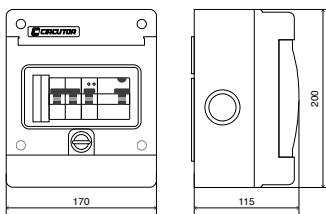

COFRET-4P

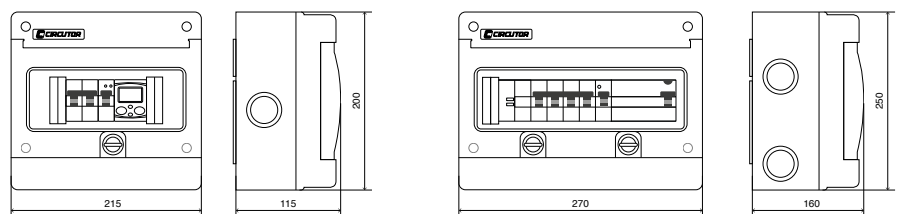

Dimensions

RVE2-P

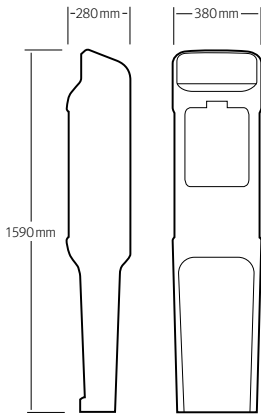

URBAN

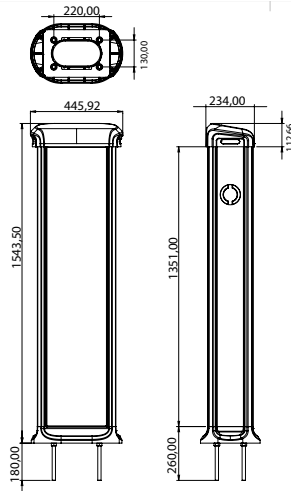

RVE-QPC

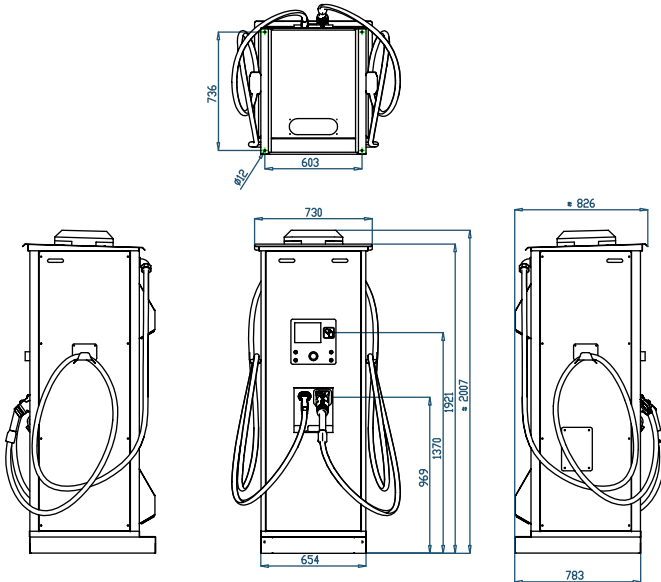

RAPTION

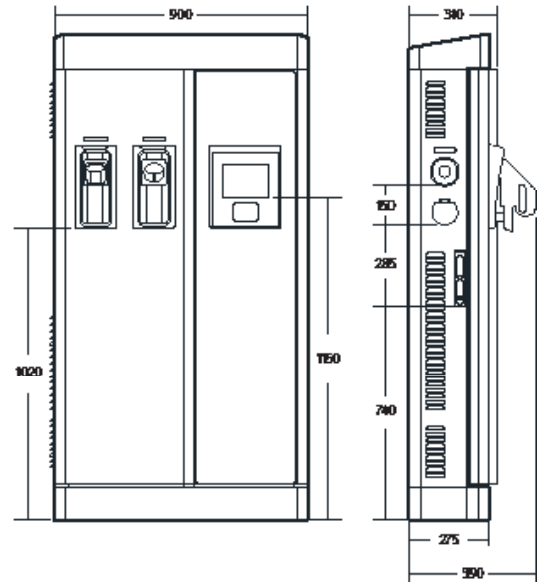

eHome

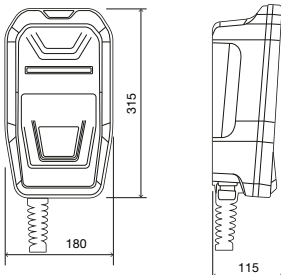

RVE-WB

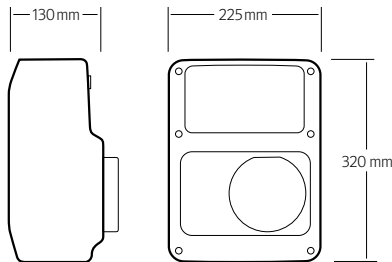



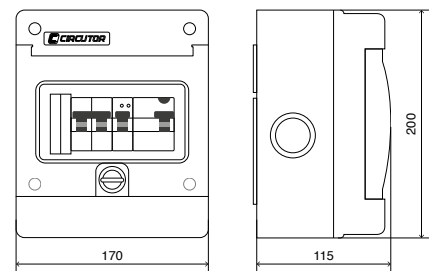

COFRET



Renewable energies

Kits for instantaneous self-consumption	
CDP, Dynamic Power Controller	162
Kits FV, On-grid Kits for instantaneous self-consumption in installations	162
Units for photovoltaic applications	
TRH, String monitoring supervision devices	163
PV-Monitor, Photovoltaic monitoring datalogger	163
Solar canopy	
PV, Solar canopy kits	164
PVS, Single-post solar canopy kits	164
Isolated network kits	
FV-ISLAND, Kits for electrification.....	165

OUTSTANDING PRODUCTS

	Kits-FV	PV	TRH16	PV-MONITOR
				
	On-grid Kits for instantaneous self-consumption in installations	Solar canopy kits	String monitoring supervision devices	Photovoltaic monitoring datalogger
página	146	148	147	147

Kits for instantaneous self-consumption



CDP, Dynamic Power Controller

Type	Code	Description
CDP-0	[C] E51001.	Dynamic power controller, zero injection
CDP-DUO	[C] E51002.	Dynamic power controller with dual configuration
CDP-G	[C] E52001.	Dynamic power controller with demand management

Requires MC (.../250 mA) series current transformers



NEW

Kits FV, On-grid Kits for instantaneous self-consumption in installations

Type	Code	PV power (Wp)	Grid type	Nr inverters	Inverters power (kW)	TOTAL power (kW)
KIT FV 1.5-S	[2] E5K011.	1,4	Single-phase 230V	1	15,0	15,0
KIT FV 1.5-S-PRO	[2] E5K012.	1,9	Single-phase 230V	1	15,0	15,0
KIT FV 2,5-S	[2] E5K021.	3,0	Single-phase 230V	1	25,0	25,0
KIT FV 2.5-S-PRO	[2] E5K022.	3,2	Single-phase 230V	1	25,0	25,0
KIT FV 3-S-T	[2] E5K123.	3,2	Three-phase 3x230/400V	1	3,0	3,0
KIT FV 4.5-M	[2] E5K130.	4,1	Three-phase 3x230/400V	3	15,0	45,0
KIT FV 5-S	[2] E5K031.	5,4	Single-phase 230V	1	5,0	5,0
KIT FV 5-S-PRO	[2] E5K032.	5,9	Single-phase 230V	1	5,0	5,0
KIT FV 5-S-T	[2] E5K131.	5,4	Three-phase 3x230/400V	1	5,0	5,0
KIT FV 5-S-PRO-T	[2] E5K132.	5,9	Three-phase 3x230/400V	1	5,0	5,0
KIT FV 6-M	[2] E5K134.	7,3	Three-phase 3x230/400V	3	2,0	6,0
KIT FV 6-S	[2] E5K033.	7,0	Three-phase 3x230/400V	1	6,0	6,0
KIT FV 6-S-PRO	[2] E5K034.	7,6	Three-phase 3x230/400V	1	6,0	6,0
KIT FV 7.5-M	[2] E5K133.	8,1	Three-phase 3x230/400V	3	25,0	75,0
KIT FV 9-M	[2] E5K037.	9,7	Three-phase 3x230/400V	3	3,0	9,0
KIT FV 9-S	[2] E5K038.	9,2	Three-phase 3x230/400V	1	8,0	8,0
KIT FV 9-S-PRO	[2] E5K039.	9,7	Three-phase 3x230/400V	1	8,0	8,0
KIT FV 11-S	[2] E5K043.	11,3	Three-phase 3x230/400V	1	10,0	10,0
KIT FV 11-S-PRO	[2] E5K044.	11,9	Three-phase 3x230/400V	1	10,0	10,0
KIT FV 15-M	[2] E5K051.	16,2	Three-phase 3x230/400V	3	5,0	15,0
KIT FV 15-M-PRO	[2] E5K052.	17,8	Three-phase 3x230/400V	3	5,0	15,0
KIT FV 15-S	[2] E5K054.	16,2	Three-phase 3x230/400V	1	15,0	15,0
KIT FV 20-S	[2] E5K061.	22,7	Three-phase 3x230/400V	1	20,0	20,0
KIT FV 20-S-PRO	[2] E5K062.	23,8	Three-phase 3x230/400V	1	20,0	20,0
KIT FV 25-M	[2] E5K071.	25,9	Three-phase 3x230/400V	2	125,0	25,0
KIT FV 25-M-PRO	[2] E5K072.	29,2	Three-phase 3x230/400V	2	125,0	25,0
KIT FV 30-M	[2] E5K081.	34,0	Three-phase 3x230/400V	2	15,0	30,0
KIT FV 30-M-PRO	[2] E5K082.	35,6	Three-phase 3x230/400V	2	15,0	30,0
KIT FV 40-M-PRO	[2] E5K200.	47,5	Three-phase 3x230/400V	2	20,0	40,0
KIT FV 60-M-PRO	[2] E5K210.	71,3	Three-phase 3x230/400V	3	20,0	60,0
KIT FV 80-M-PRO	[2] E5K220.	95,0	Three-phase 3x230/400V	4	20,0	80,0
KIT FV 100-M-PRO	[2] E5K230.	118,8	Three-phase 3x230/400V	5	20,0	100,0

FV KITS (tariff) are supplied with the following:

270 Wp Modules
Secondary support structure
Inverter(s)

In addition, FV KITS can be supplied with two electric panel models, which include the DC protection elements (StringBox) and AC protection elements at the inverter output (CombinerBox):

CDP Protection and control panels

StringBox

CombinerBox CDP (includes CDP-DUO and CVM-Mini analyser)

CDP Protection and control and PV-Monitor-M monitoring panels

StringBox TR (includes TRH16 and M/TR current measuring modules)

CombinerBox PV (includes CDP-DUO, CVM-Mini analyser and PV-Monitor-M)

Environmental sensors (radiation and temperature panels/ambient)

The support structure types must be specified before the order for the FV KIT is accepted.

The use of MC Current transformers must be specified if the FV KIT is supplied with electric protection panels.



Kits FV		E	5	X	X	X	X	0	0	X	X	X	X	X
Code														
Current transformers	MC3-63A													
	MC3-125A													
	MC3-250A													
	MC1-20-150/200/250													
	MC1-30-250/400/500													
	MC1-55-500/1000/1500													
	MC1-80-1000/1500/2000													
	Ninguno*													
Protection	Cutting power 15 kA													
	Cutting power 55 kA													
Electrical Panels. Protection and control complement CDP-0	CDP CB S-1-1-1-16-30 (compatible with Kits FV 1.5-S / 1.5-S-PRO / 2.5-S / 2.5-S-PRO)												1	0
	CDP CB S-1-1-1-16-300 (compatible with Kits FV 1.5-S / 1.5-S-PRO / 2.5-S / 2.5-S-PRO)												2	0
	CDP CB S-2-1-1-25-30 (compatible with Kits FV 5-S / 5-S-PRO)												3	0
	CDP CB S-2-1-1-25-300 (compatible with Kits FV 5-S / 5-S-PRO)												4	0
	CDP CB T-2-2-1-25-300 (compatible with Kits FV 3-S-T / FV 5-S-T / 5-S-PRO-T / 6-S / 6-S-PRO)												5	0
	CDP CB T-0-0-1-25-300 + 1 CDP SB 2-1-1 (compatible with Kits FV 9-S / 9-S-PRO / 11-S / 11-S-PRO)												6	0
	CDP CB T-0-0-1-25-300 + 1 CDP SB 4-2-2 (compatible with Kits FV 15-S)												7	0
	CDP CB T-0-0-2-25-300 + 2 CDP SB 4-2-2 (compatible with Kits CDP 25-M / 25-M-PRO)												8	0
	CDP CB C-0-0-3-25-300 + 3 CDP SB 2-1-1 (compatible with Kits CDP 15-M / 15-M-PRO)												9	0
	CDP CB C-1-3-3-16-300 (compatible with kit CDP 4.5-M / 6-M / 7.5-M / 9-M)												A	0
	CDP CB T-0-0-2-40-300 + 2 CDP SB 4-2-2 (compatible with kits CDP 40-M-PRO)												B	0
	CDP CB T-0-0-3-40-300 + 3 CDP SB 4-2-2 (compatible with kits CDP 60-M-PRO)												C	0
	CDP CB T-0-0-4-40-300 + 4 CDP SB 4-2-2 (compatible with kits CDP 80-M-PRO)												D	0
	CDP CB T-0-0-5-40-300 + 5 CDP SB 4-2-2 (compatible with kits CDP 100-M-PRO)												E	0
	CDP CB T-0-0-1-40-300 + 1 CDP SB 4-2-2 (compatible with kits CDP 20-S / CDP 20-S-PRO)												I	0
Electrical Panels. Protection & Control complement CDP-0 and PV-MONITOR for monitoring	CDP PV T-0-0-1-40-300 + 1 CDP SB 4-2-2-TRH16 + environmental sensors (compatible with Kits CDP 30-M / 30-M-PRO)												0	1
	CDP PV T-0-0-2-25-300 + 1 CDP SB 8-4-4-TRH16 + environmental sensors (compatible with Kits CDP 15-S / 20-S / 20-S-PRO)												0	2
	CDP PV T-0-0-2-40-300 + 1 CDP SB 8-4-4-TRH16 + environmental sensors (compatible with kits CDP 40-M-PRO)												0	3
	CDP PV T-0-0-3-40-300 + 1 CDP SB 12-3-3-TRH16 + environmental sensors (compatible with kits CDP 60-M-PRO)												0	4
	CDP PV T-0-0-4-40-300 + 1 CDP SB 16-4-4-TRH16 + environmental sensors (compatible with kits CDP 80-M-PRO)												0	5

In case the measurement of installation consumption requires the use of split-core transformers .../5 A (due to the presence of busbars .../5 A), or larger cross-section diameters) must be accounted for separately from the KIT together with 1 power analyser type **CVM-MINI-ITF-RS485-C2**.

Units for photovoltaic applications

TRH, String monitoring supervision devices

230 Vac / 24 Vdc Power supply voltage

agrupador

NEW

Type	Code	Description
TRH16-RS485	[*] E80005.	16 configurable channels, 25/100/200 A 1500 Vdc voltage measurement Three voltage-free digital inputs 1 Pt100 / Pt1000 probe input 1 Input 0...20 mA
Measuring module		
M/TR-25 Acc X 2	[*] E80010.	Measuring module for 2 current circuits. Maximum current: 25 Adc
M/TR-25 Acc X 4	[*] E80011.	Measuring module for 4 current circuits. Maximum current: 25 Adc
M/TR-100 Acc	[*] E80012.	Measuring module for 1 current circuit. Maximum current: 100 Adc
M/TR - 200 Acc	[*] E80013.	Measuring module for 1 current circuit. Maximum current: 200 Adc

NOTE: Complete unit: 25 A TR8-RS485-25 (E80000) + (1 or 2) M/TR-25x4 (E80011) 100 A TR8-RS485-100/200(E80001) + (1 ... 8) M/TR-100 (E80012) 200 A TR8-RS485-100/200 (E80001) + (1 ... 8) M/TR-200 (E80013)

PV-Monitor, Photovoltaic monitoring datalogger

Type	Code	Description
PV-Monitor	[2] E8100*.	Datalogger for photovoltaic installations
PV-Monitor-M	[2] E8110*.	Datalogger for photovoltaic installations with meteorological monitoring system

* 1=Spanish / 2= French / 3=English Examples: E81001=Spanish / E81102= French

Type	Code	Description
MET-485	[*] EX0095.	Temperature sensor for photovoltaic panels
RT-N150	[1] EX0056.	CIRCUTOR Router

Delivery time: [*] immediate
[x] working weeks
[c] consult

Solar canopy



NEW

PV, Solar canopy kits

Type	Code	PV power (Wp)	Nr inverters	Spaces	No. of Blinding concrete plates	Size (mm) width xheight xdepth
PV2, Single solar canopy						
PV2 C2PS	[C] E6P202.	4,1	1 x 3,7 kW	2	2	5000x3500x4800
PV2 C3PS	[C] E6P203.	6,5	1 x 5 kW	3	2	8000x3500x4800
PV2 C4PS	[C] E6P204.	8,1	1 x 7 kW	4	3	10000x3500x4800
PV2 C6PS	[C] E6P206.	12,2	1 x 10 kW	6	3	15000x3500x4800
PV2 C8PS	[C] E6P208.	16,2	1 x 15 kW	8	4	20000x3500x4800
PV2 C10PS	[C] E6P210.	20,3	1 x 20 kW	10	5	25000x3500x4800
PV2 C12PS	[C] E6P212.	24,3	1 x 20 kW	12	5	30000x3500x4800
PV2 C16PS	[C] E6P216.	32,4	2 x 15 kW	16	7	40000x3500x4800
PV2 C18PS	[C] E6P218.	36,5	3 x 12,5 kW	18	7	45000x3500x4800
PV2 C20PS	[C] E6P220.	40,5	2 x 15 kW	20	8	50000x3500x4800
PV2 C22PS	[C] E6P222.	44,6	3 x 15 kW	22	9	55000x3500x4800
PV2 C24PS	[C] E6P224.	48,6	3 x 15 kW	24	9	60000x3500x4800
PV2 C26PS	[C] E6P226.	52,7	3 x 17,5 kW	26	10	65000x3500x4800
PV2 C28PS	[C] E6P228.	56,7	3 x 20 kW	28	11	70000x3500x4800
PV2 C30PS	[C] E6P230.	60,8	3 x 20 kW	30	11	75000x3500x4800
PV2 C32PS	[C] E6P232.	64,8	3 x 20 kW	32	12	80000x3500x4800
PV2 C34PS	[C] E6P234.	68,9	3 x 20 kW	34	13	85000x3500x4800
PV2 C36PS	[C] E6P236.	72,9	3 x 20 kW	36	13	90000x3500x4800
PV2 C38PS	[C] E6P238.	77,0	3 x 20 kW	38	14	95000x3500x4800
PV2 C40PS	[C] E6P240.	81,0	4 x 20 kW	40	15	100000x3500x4800
PV2 C42PS	[C] E6P242.	85,1	4 x 20 kW	42	15	105000x3500x4800
PV4, Double solar canopy						
PV4 C4PD	[C] E6P404.	8,1	1 x 7 kW	4	2	5000x3600x9700
PV4 C6PD	[C] E6P406.	13,0	1 x 10 kW	6	2	8000x3600x9700
PV4 C8PD	[C] E6P408.	16,2	1 x 15 kW	8	3	10000x3600x9700
PV4 C12PD	[C] E6P412.	24,3	1 x 20 kW	12	4	15000x3600x9700
PV4 C16PD	[C] E6P416.	32,4	2 x 15 kW	16	4	20000x3600x9700
PV4 C20PD	[C] E6P420.	40,5	2 x 20 kW	20	5	25000x3600x9700
PV4 C24PD	[C] E6P424.	48,6	3 x 15 kW	24	5	30000x3600x9700
PV4 C28PD	[C] E6P428.	56,7	3 x 20 kW	28	6	35000x3600x9700
PV4 C32PD	[C] E6P432.	64,8	3 x 20 kW	32	7	40000x3600x9700
PV4 C36PD	[C] E6P436.	72,9	3 x 20 kW	36	7	45000x3600x9700
PV4 C40PD	[C] E6P440.	81,0	4 x 20 kW	40	8	50000x3600x9700
PV4 C44PD	[C] E6P444.	89,1	4 x 20 kW	44	9	55000x3600x9700

PV KITS (tariff) are supplied with the following material: • 270 Wp Modules • Canopy structure • Inverter(s) In addition, PV KITS can be supplied with two electric panel modules, which include the DC protection elements (StringBox) and AC protection elements at the inverter output (CombinerBox); • CDP Protection and control panels - StringBox - CombinerBox CDP (includes CDP-DUO and CVM-MINI analyser) • CDP Protection and control and PV-Monitor-M monitoring panels - StringBox TR (includes TRH16 and M/ TR current measuring modules) - CombinerBox PV (includes CDP-DUO, CVM-Mini analyser and PV-Monitor-M) - Environmental sensors (radiation and temperature panels/ ambient) The canopy is supplied by default in all PV KITS. As an option, 2 WallBox electric vehicle charging units can be supplied; these will be integrated on the canopy's legs, one on the start foot and the other on the end foot. Compatible CIRCUTOR WallBox units: - WB-eBasic Range - RVE-WB Range (single connection) In addition, the price includes the templates and RAL colour paint selected by the customer. The use of MC Current transformers must be specified if the FV KIT is supplied with electric protection panels.

FREIGHT NOT INCLUDED

MC CURRENT TRANSFORMERS NOT INCLUDED

NEW

PVS, Single-post solar canopy kits

Type	Code	PV power (Wp)	Grid type	Nr inverters	Spaces	No. of Blinding concrete plates	Size (mm) width xheight xdepth
PVS M2M	[C] E6P102.	4,1	Single-phase	1 x 3,6 kW	2	1	5040x3488x4784
PVS M2T	[C] E6P120.	4,1	Three-phase	1 x 3,7 kW	2	1	5040x3488x4784

Available options: • Colour of the canopy structure, marked with the company logo • Other options and configurations available on special order FREIGHT NOT INCLUDED MC CURRENT TRANSFORMERS NOT INCLUDED

Delivery time: [*] immediate
[x] working weeks
[c] consult



Kits PV													
E	5	P	X	X	X	0	0	0	X	X		X	X
Code													
Current transformers	MC3-63A								0				
	MC3-125A								1				
	MC3-250A								2				
	MC1-20-150/200/250								3				
	MC1-30-250/400/500								4				
	MC1-55-500/1000/1500								5				
	MC1-80-1000/1500/2000								6				
Protection													
Cutting power for AC protections CombinerBox up to 15 kA								0					
Cutting power for AC protections CombinerBox up to 55 kA								1					
Electrical Panels. Protection and control complement CDP-0													
CDP CB T-0-0-1-10-300 + 1 CDP SB 2-1-1 (compatible with Kits C2PS)								1	0				
CDP CB T-0-0-1-16-300 + 1 CDP SB 2-1-1 (compatible with Kits C3PS)								2	0				
CDP CB T-0-0-1-16-300 + 1 CDP SB 2-2-2 (compatible with Kits C4PS y C4PD)								3	0				
CDP CB T-0-0-1-25-300 + 1 CDP SB 4-2-2 (compatible with Kits C6PS, C8PS, C6PD y C8PD)								4	0				
CDP CB T-0-0-1-40-300 + 1 CDP SB 6-2-2 (compatible with Kits C10PS, C12PS y C12PD)								5	0				
CDP CB T-0-0-2-25-300 + 1 CDP SB 6-2-2 (compatible with Kits C16PS y C16PD)								6	0				
CDP CB T-0-0-2-25-300 + 2 CDP SB 6-2-2 (compatible with Kits C20PS)								7	0				
CDP CB T-0-0-3-25-300 + 3 CDP SB 4-2-2 (compatible with Kits C18PS, C22PS, C24PS, C24PD)								8	0				
CDP CB T-0-0-2-40-300 + 1 CDP SB 4-2-2 + 1 CDP SB 6-2-2 (compatible with Kits C20PD)								9	0				
CDP CB T-0-0-3-40-300 + 2 CDP SB 4-2-2 + 1 CDP SB 6-2-2 (compatible with Kits C26PS)								A	0				
CDP CB T-0-0-3-40-300 + 3 CDP SB 4-2-2 (compatible with Kits C28PS, C30PS, C32PS, C28PD y C32PD)								B	0				
CDP CB T-0-0-3-40-300 + 3 CDP SB 6-2-2 (compatible with Kits C34PS, C36PS, C38PS, C36PD)								C	0				
CDP CB T-0-0-4-40-300 + 4 CDP SB 6-2-2 (compatible with Kits C40PS, C42PS, C40PD y C44PD)								D	0				
Electrical Panels. Protection & Control complement CDP-0 and pv-monitor for monitoring													
CDP PV T-0-0-1-16-300 + 1 CDP SB 2-1-1-TRH16 + environmental sensors (compatible with Kits C4PS y C4PD)								0	3				
CDP PV T-0-0-1-25-300 + 1 CDP SB 2-1-1-TRH16 + environmental sensors (compatible with Kits C6PS, C8PS, C6PD y C8PD)								0	4				
CDP PV T-0-0-1-40-300 + 1 CDP SB 2-2-2-TRH16 + environmental sensors (compatible with Kits C10PS, C12PS y C12PD)								0	5				
CDP PV T-0-0-2-25-300 + 1 CDP SB 4-2-2-TRH16 + environmental sensors (compatible with Kits C16PS y C16PD)								0	6				
CDP PV T-0-0-2-25-300 + 1 CDP SB 6-2-2-TRH16 + environmental sensors (compatible with Kits C16PS y C16PD)								0	7				
CDP PV T-0-0-3-25-300 + 1 CDP SB 15-3-3-TRH16 + environmental sensors (compatible with Kits C22PS, C28PS)								0	8				
CDP PV T-0-0-3-40-300 + 1 CDP SB 15-3-3-TRH16 + environmental sensors (compatible with Kits C26PS, C30PS, C34PS, C36PS, C38PS y C36PD)								0	9				
CDP PV T-0-0-3-25-300 + 1 CDP SB 12-4-4-TRH16 + environmental sensors (compatible with Kits C24PS, C24PD)								0	A				
CDP PV T-0-0-2-40-300 + 1 CDP SB 15-3-3-TRH16 + environmental sensors (compatible with Kits C20PD)								0	B				
CDP PV T-0-0-3-40-300 + 1 CDP SB 12-3-3-TRH16 + environmental sensors (compatible with Kits C32PS, C28PD, C32PD)								0	C				
CDP PV T-0-0-4-40-300 + 1 CDP SB 16-4-4-TRH16 + environmental sensors (compatible with Kits C40PS, C42PS, C40PD y C44PD)								0	D				

In case the measurement of installation consumption requires the use of split-core transformers .../5 A (due to the presence of busbars .../5 A) or larger cross-section diameters) must be accounted for separately from the KIT together with 1 power analyser type **CVM-MINI-ITF-RS485-C2**.

Isolated network kits

NEW

FV-ISLAND, Kits for electrification



Type	Code	PV power (Wp)	Grid type	Inverters power (kW)	Daily consumption (Wh/day)	Battery (V/Ah)
FV-ISLAND S-3000	[C] E4K394.	1,560,0	1 x 230 V	3,0	3640	24 / 575
FV-ISLAND S-3500	[C] E4K4C5.	2,340,0	1 x 230 V	35,0	4680	48 / 360
FV-ISLAND S-5000	[C] E4K5D6.	3,120,0	1 x 230 V	5,0	6240	48 / 575
FV-ISLAND S-7000	[C] E4K6E7.	4,680,0	1 x 230 V	7,0	9360	48 / 850
FV-ISLAND S-10000	[C] E4K7F8.	6,240,0	1 x 230 V	10,0	12480	48 / 1130
FV-ISLAND T-10500	[C] E4K8G8.	7,800,0	3 x 230 / 400 V	105,0	14144	48 / 1695
FV-ISLAND T-21000	[C] E4K9H9.	14,040,0	3 x 230 / 400 V	21,0	28288	48 / 2600

The FV-ISLAND kits consist of: - Modules - Structure - Load regulator - Investor - Batteries (lead OPzV acid) -DC and AC Protection Boards Please contact us to receive further information about other configurations.

Dimensions

TRH16

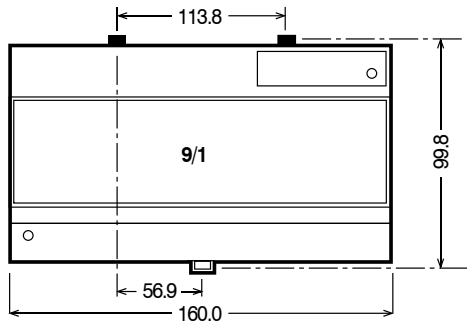

CDP / PV-MONITOR

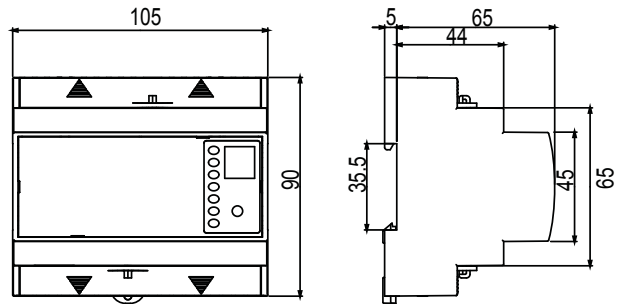

PV

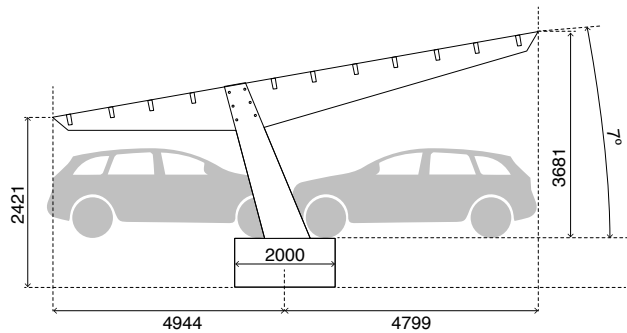
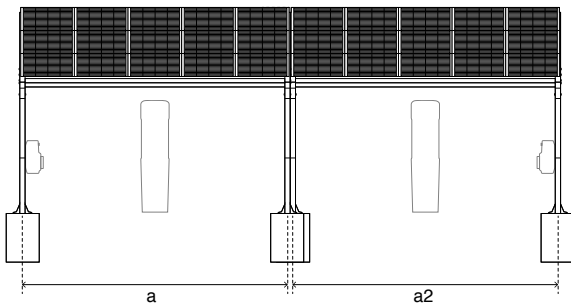
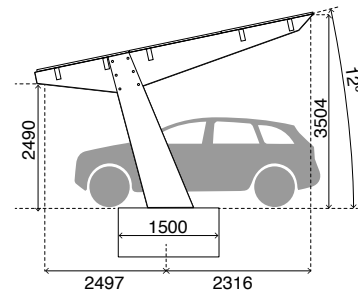
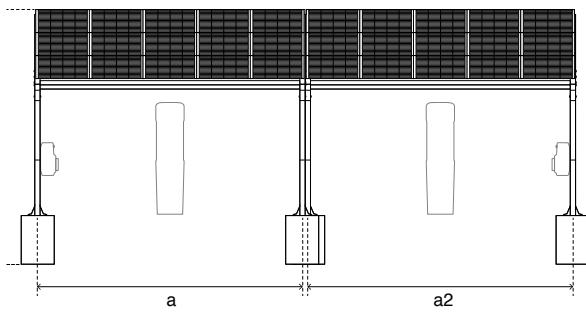
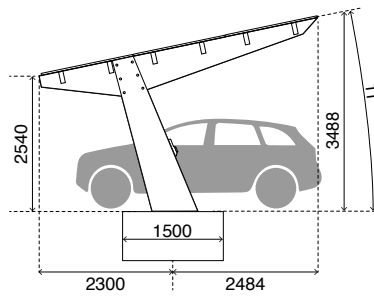
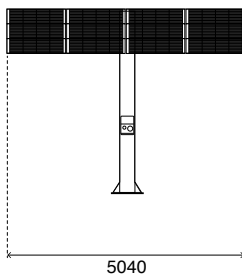

INDEX BY TYPE

GENERAL INDEX by Type alphabetical order

TYPE	DESIGNATION	PAGE
2EC	Double voltmeters	77
2HC / 2HLC	Double frequencymeters	77
ACF	CSB capacitor with contactor and fuses	131
AFQevo	Active multifunction filter	145
AIR	Wireless converters and probes	47
BC / BM	Moving coil ammeters	67
BC / BM	Moving coil voltmeters	68
BC / BM / CBC	Moving coil ammeters	67
BC / BM / CBC	Moving coil voltmeters	68
BC / BM / ZC	Process indicators	69
CAVA	Power Quality Single-Phase Analyzers	52
CBC	Moving coil ammeters	67
CBC	Moving coil voltmeters	68
CBS-4	Station with 4 programmable earth leakage relays, 4 modules with display and a configurable prealarm output.	98
CBS4-RA	Central protection and earth leakage reclosing with WGC external transformer	103
CC	Current transducer	56
CCE	Current transducers, Narrow section	56
CCOS	Cos ϕ transducer	57
CDP	Dynamic Power Controler	162
CDR	Station with 8 current relays, display and RS-485 communications	109
CEC	Moving Iron Milliammeters and Ammeter	62
CEC	Moving Iron Voltmeters	65
CEM	Single-phase and three-phase energy meters	91
CEM	Single-phase and three-phase energy meters	92
CEM-6	Single-phase energy meter with basic analyser parameters	26
CEM-M	Communication module	91
CF	Frequency transducers	57
CFB	Power capacitors for harmonic filtering (for FR)	125
CFB-6B	Power capacitors for harmonics filters with static switching operation of the FRE series	127
CFE	Frecuency transducers, Narrow section	56
CH	Hour run meters	78
CHV-M	Single-phase MV power capacitors (indoor and outdoor use)	149
CHV-T	Three-phase MV power capacitors	150
CIR-e+	Energy audit analyzer	51
CirBEON	Sensor for dynamic control of charging power	158
CirCAMP	Meters for managing multiple supplies	90
CirCAMP-BOX	Compact cabinets for the CirCAMP system	90
CirLAMP	Public lighting control system	46
CIRMANAGER	Concentrator for managing the CirCAMP system	90
CIRWATT B II	Single-phase energy meter	83
CIRWATT B II PRIME	Single-phase energy meters with PLC system (measuring, load profiling, multi configurable billing calendar)	84
CIRWATT B III	Three-phase energy meters (Measuring, load profiling, multi configurable billing calendar)	83
CIRWATT B III PRIME	Three-phase energy meters with PLC system (measuring, load profiling, multi configurable billing calendar)	84
CIRWATT P	Prepayment energy meters	84
CIRWATT-repeater	Repeater for amplification of the PLC signal for the PRIME system	84
CLP	Power capacitor with circuit breaker	130
CLP-C	CLZ Capacitor with circuit breaker and contactor	130
CLZ-FP-M	Single-phase tubular power capacitor	120
CLZ-FP23 HD	Tubular power capacitor	120
CLZ-FP24-60 HD	Three-phase tubular power capacitor, 60 Hz	122

GENERAL INDEX by Type alphabetical order

TYPE	DESIGNATION	PAGE
CLZ-FP48 HD	Tubular power capacitor	121
CLZ-FP60-60 HD	Three-phase tubular power capacitor, 60 Hz	123
CMBUS	Communication converters	30
CMC	Contactors with fast discharge resistor	123
CMC	Contactors with fast discharge resistor	123
COFRET	Protection box for single-phase charging points	158
COMPACT DC	PRIME PLC Concentrator	84
computer Max P&P	Power factor regulators	118
computer Max-f	Power factor regulators for static switching	119
computer one	Power factor relay 1 step, IP 00	118
computer Smart III	Three-phase power factor regulators. Regulation, measurement, leakage control and communications	118
Computer SMART III-Fast	Power factor regulators for static switching	119
computer two	Power factor regulator 2 step, IP 00	118
CONNEC	Other accessories	158
CPF	Power Factor transducer	57
CPF / CCOS	Power Factor & Cos ϕ transducer	57
CPG	Clamps	50
CPG	Clamps	51
CQ	Power capacitors for LV	128
CR	Relay tester	113
CSB	Power capacitors for LV	124
CSB-2V	Power capacitors for LV dual voltage	124
CSB-A	Fixed capacitors with automatic protection 50 Hz	128
CSB-F	Power capacitors with fuse protection	129
CSB-M	Power capacitors with circuit breaker protection	129
CUC	Phase sequence indicators	77
CV	Transducer Voltage	56
CV	Power capacitors for LV	128
CVE	Voltage transducers, Narrow section	56
CVE/CCE/CFE	Narrow section transducers	56
CVM-A	Power quality analyzers, colour display, panel mounted	24
CVM-A	Power quality analyzers, colour display, panel mounted	29
CVM-B	Power analyzer, colour display, panel mounted	24
CVM-C10	Power analyzer, panel mounted 96 x96	25
CVM-MINI	Power analyzer, three-phase DIN rail	26
CVM-NET	Power analyzer, three-phase DIN rail	26
CVM-NET4	Power analyzer, 4 analyzers in a single unit, DIN rail	26
CVM-C5	Power analyzer, panel mounted 96x96	25
CW	Active Power transducer	57
CY	Reactive power transducer	57
Databox	Plataforma cloud	48
DC-B	Digital instruments	54
DH96	DC multimeter	55
DHB	Digital instruments	55
DIR2	Power factor relay 1 step. din rail	118
DM45	Digital instruments	53
EC / EM / EZC	Moving Iron Miliammeters and Ammeter	62
EC / EM / EZC	Moving Iron Voltmeters	65
EC / EM / EZC / CEC	Moving Iron Miliammeters and Ammeter	62
EC / EM / EZC / CEC	Moving Iron Voltmeters	65
EDMk	Three-phase energy meters, external current transformer	91

GENERAL INDEX by Type alphabetical order

TYPE	DESIGNATION	PAGE
EDS	Energy manager with powerStudio and built-in web server	45
eHome	Car park boxes, mode 3	157
ELEB	CSB coils	123
EMC	maximeter ammeters	71
FAR-Q	Hybrid absorption filters	147
FB3	Third harmonic blocking filter for 50 Hz network	147
FEMC / FETC	Phasemeters	75
FEMC / FETC / FMZ / FTC / PIC	Phasemeters	75
FLEX	Flexible Clamps	51
FLEX-MAG	Flexible sensors for CVM-C10-FLEX	25
FLEX-RMG	Clamps	50
FMZ / FTC	Phasemeters	75
FV-ISLAND	Kits for electrification	165
GETEST	Indirect earth contact simulator	113
HC / HM / HZC / HLC	Frequencymeters	72
IDB-4	RCCB Type B	99
IMD-2R	Monitoring relay for offline insulation	109
IR	urrent limiting impedances	123
kit3-TRMC210	Sets of 3 current transformers for energy meters	39
kit3-TRMC400	Sets of 3 current transformers for energy meters	39
Kits FV	On-grid Kits for instantaneous self-consumption in installations	162
LCL	Harmonic filters for power converters	146
LCL-TH	Filter for elevators	146
LM	Impulse and contact centralisers	45
LOC	Optical reader	85
LR	Filter reactors for power converters (network side)	145
LVC	Three-phase contactor for MV capacitors	151
M-CVM-AB	Expansion modules for CVM-A and CVM-B	24
MC / MMC / EMC	maximeter ammeters	71
MC1	Triple scale single-phase efficient transformers	37
MC3	Three-phase current transformers	37
MCB	Motorized circuit breakers for overcurrent and earth leakage protection with reclosing by differential relay	104
MD	Megaohmmeters	113
MDC	Maximum demand control devices	46
MEG-1000	Insulation resistance meter	78
MH	Microohmmeter	113
MK-DC	Direct current energy meter	92
Modems	Communication accessories	47
MT-FDE	Motorized circuit breaker for currents exceeding than 63 A	106
MyCLAMP	Portable clamp meter	85
MYeBOX	Portable power analyzer with recording of quality events and transients in accordance with (IEC 61000-4-30 Ed.2) Class A	50
MYeBOX-A	Portable power analyzer with recording of quality events and transients Calibration Certificate (IEC 61000-4-30 Ed.2) Class A	50
OPTIM EMK	Automatic capacitor banks with static contactor	139
OPTIM EMS	Automatic capacitor banks with static contactor	138

GENERAL INDEX by Type alphabetical order

TYPE	DESIGNATION	PAGE
OPTIM FR P&P	Automatic capacitor banks with rejection filters (contactors switching)	136
OPTIM FRE	Automatic capacitor banks with rejection filters (static contactor)	140
OPTIM FRF	Fixed capacitors with rejection reactance of $p = 7\%$	136
OPTIM FRM	Fixed capacitors with rejection reactance of $p = 7\%$	136
OPTIM HYB	Semi-fast hybrid automatic capacitor banks with phase-by-phase compensation for unbalanced networks	135
OPTIM P&P	Automatic capacitor banks, 2.5 to 1600 kvar	134
OT2	Dielectric strenght tester	113
PD	Pedestal for RVE-WB and eHome	158
PGR	Protection vatmeters	76
PI-23	Pinzas amperimétricas alta tensión	114
PIC	Phasemeters	75
Pinzas FLEX-R	Clamps	51
PowerStudio	Energy management software	93
PowerVision/CIR-ENERGY	Energy management software	48
PowerWat	Software for energy meters	85
PV	Solar canopy kits	164
PV-Monitor	Photovoltaic monitoring datalogger	163
PVS	Single-post solar canopy kits	164
QNA500	Advanced power quality analyzers (according Standard EN-50160 and IEC-61000-4-30)	29
RAPTION 22	Compact fast charging stations, mode 3 and 4	156
RAPTION 50	Compact fast charging stations, mode 3 and 4	156
RBX	Reactors III for detuned static filters	126
RD	Fast discharging resistors	123
RE-RBE	Reactors III for detuned static filters with FRE static switching	127
ReadWatt	Impulse collection with communication	46
REC3	RCCB with self-reclosing system, type A	103
RECmax-CVM	Self-reclosing earth leakage really with power analyzer functions, transformers included	104
RECmaxLPD	Self-reclosing earth leakage relay with circuit breaker, used with an external earth leakage transformer	105
RECmaxMP	Motorized circuit breakers (up to 63 A)	106
RECmaxP	Motorized circuit breakers, up to 63 A	107
RG1M	Earth leakage relays 1 module	97
RGE	Earth leakage relay for WGC transformer, type A, 2 modules with visual prealarm.	97
RGMD	Earth leakage protection assembly with miniature circuit breaker, ultra-immunised	99
RGU-10	Earth leakage relay for Type A ultra-immunised WGC Transformer, 3 modules with display and programmable pre-alarm output.	97
RGU-10 MT	Reclosing earth leakage relay for motorized circuit breakers	105
RGU-10 RAL	Reclosing protection relays and earth leakage reclosing with WGC external transformer	103
RGU-10B	Earth leakage current monitoring relay, type-B	99
RGU-2	Programmable earth leakage relay, 2 modules with display and static prealarm output	97
RMV	Choke reactors for MV capacitor banks	151
RRM	Overcurrent tripping relay with self-reclosing system	107
RS	Communication converters	30
RS/TCP/CMBUS	Communication converters	46
RV	Voltage detector relays (AC), DIN rail	109
RVE-CARD	Prepayment system	158
RVE-WB	Car park boxes	157
RX / RBX	Reactors III for detuned static filters	126
SBOX	Gateway for DataBox platform	48
SC3	Split three-phase current transformers	37

GENERAL INDEX by Type alphabetical order

TYPE	DESIGNATION	PAGE
SH	Shunts	41
SINUS	Filter for PWM	146
SMC / STC	Synchrosopes, 50 Hz	77
STP	Current transformers, split core	37
SynchroMAX	Synchronization equipment	77
TA	Current transformers, winding primary	38
TA 210	Current transformers, winding primary	38
TB	Bacon control equipment	109
TC	Current transformers narrow section	33
TC-020	Current transformers with converter 4...20 mA or 0...20 mA	58
TCH	Current transformers narrow section and high accuracy	35
TCLZ	IP 54 covers for CLZ-FP	120
TCP	Communication converters	30
TE	Transformador elevador	42
Temp	Ohm, aislam, proceso, Transducers	57
TH-DG	Photovoltaic monitoring	46
TI	Current transformer with converter 4...20 mA	58
TL	Earth resistance meter	113
TM45	Current transformers, winding primary, DIN rail	37
TP	Current transformers, split core	36
TP-WG	Split-core earth leakage transformers/core balanced	97
TRH	String monitoring supervision devices	163
TRM	Measuring transformers encapsulated in resin	40
TRMCx3	Current transformers for energy meters	86
TRP	Protection transformers encapsulated in resin	111
TSR	Transformador sumador	42
UC	Phase sequence indicators	77
URBAN	Outdoor slow charging posts - mode 1, 2 and 3	156
VLOG	Power quality analyzer	52
VT	Transformador de medida de tensión	42
WB-eBasic	Car park boxes, mode 3	157
WGB-35-TB	Relay Type B built-in earth leakage current transformer	99
WGBU	Transformer with built-in earth leakage relay, Type A.	98
WGC	Earth leakage transformer	96
WGC-TB	Earth leakage transformers for type-B earth leakage relays	99
WI	Current detector relay (AC), DIN rail	109
Wibeee	Consumption analyzers	27
Wibeee Max	Consumption analyzers	27
WMC / WTC	Wattmeters	73
WMC / WTC / YMC / YTC	Wattmeters and varmeters	73
WRGU-10-MTT	Full earth leakage and circuit breaker reclosing and protection unit, panel	107
WRN	Earth leakage relay with built-in transformer, Type A	98
WRU	Type A ultra-immunised earth leakage relay with built-in transformer	98
WRU-10k	Earth leakage relay with built-in transformer	104
WRU-10MT	Earth leakage relay with built-in transformer	106
WRU-10RAL	Protection relays and earth leakage reclosing, Type A ultra-immunised with built-in transformer	103
YMC / YTC	Varmeters	73

INDEX BY DESIGNATION

GENERAL INDEX by Designation alphabetical order

DESIGNATION	TYPE	PAGE
Active multifunction filter	AFQevo	145
Active Power transducer	CW	57
Advanced power quality analyzers (according Standard EN-50160 and IEC-61000-4-30)	QNA500	29
Automatic capacitor banks with rejection filters (contactors switching)	OPTIM FR P&P	136
Automatic capacitor banks with rejection filters (static contactor)	OPTIM FRE	140
Automatic capacitor banks with static contactor	OPTIM EMK	139
Automatic capacitor banks with static contactor	OPTIM EMS	138
Automatic capacitor banks, 2.5 to 1600 kvar	OPTIM P&P	134
Bacon control equipment	TB	109
Car park boxes	RVE-WB	157
Car park boxes, mode 3	eHome	157
Car park boxes, mode 3	WB-eBasic	157
Central protection and earth leakage reclosing with WGC external transformer	CBS4-RA	103
Choke reactors for MV capacitor banks	RMV	151
Clamps	CPG	50
Clamps	FLEX-RMG	50
Clamps	Pinzas FLEX-R	51
CLZ Capacitor with circuit breaker and contactor	CLP-C	130
Communication accessories	Modems	47
Communication converters	CMBUS	30
Communication converters	RS	30
Communication converters	TCP	30
Compact cabinets for the CirCAMP system	CirCAMP-BOX	90
Compact fast charging stations, mode 3 and 4	RAPTION 22	156
Compact fast charging stations, mode 3 and 4	RAPTION 50	156
Comunication module	CEM-M	91
Concentrator for managing the CirCAMP system	CIRMANAGER	90
Consumption analyzers	Wibeee	27
Consumption analyzers	Wibeee Max	27
Contactors with fast discharge resistor	CMC	123
Contactors with fast discharge resistor	CMC	123
Cos ϕ transducer	CCOS	57
CSB capacitor with contactor and fuses	ACF	131
CSB coils	ELEB	123
Current detector relay (AC), DIN rail	WI	109
Current limiting impedances	IR	123
Current transducer	CC	56
Current transducers, Narrow section	CCE	56
Current transformer with converter 4...20 mA	TI	58
Current transformers for energy meters	TRMCx3	86
Current transformers narrow section	TC	33
Current transformers narrow section and high accuracy	TCH	35
Current transformers with converter 4...20 mA or 0...20 mA	TC-020	58
Current transformers, split core	STP	37
Current transformers, split core	TP	36
Current transformers, winding primary	TA	38
Current transformers, winding primary	TA 210	38
Current transformers, winding primary, DIN rail	TM45	37
DC multimeter	DH96	55
Dielectric strenght tester	OT2	113
Digital instruments	DC-B	54

GENERAL INDEX by Designation alphabetical order

DESIGNATION	TYPE	PAGE
Digital instruments	DHB	55
Digital instruments	DM45	53
Direct current energy meter	MK-DC	92
Double frequencymeters	2HC / 2HLC	77
Double frequencymeters	2HC / 2HLC	77
Double voltmeters	2EC	77
Dynamic Power Controler	CDP	162
Earth leakage current monitoring relay, type-B	RGU-10B	99
Earth leakage protection assembly with miniature circuit breaker, ultra-immunised	RGMD	99
Earth leakage relay for Type A ultra-immunised WGC Transformer, 3 modules with display and programmable pre-alarm output.	RGU-10	97
Earth leakage relay for WGC transformer, type A, 2 modules with visual prealarm.	RGE	97
Earth leakage relay with built-in transformer	WRU-10k	104
Earth leakage relay with built-in transformer	WRU-10MT	106
Earth leakage relay with built-in transformer, Type A	WRN	98
Earth leakage relays 1 module	RG1M	97
Earth leakage transformer	WGC	96
Earth leakage transformers for type-B earth leakage relays	WGC-TB	99
Earth resistance meter	TL	113
Energy audit analyzer	CIR-e+	51
Energy management software	PowerStudio	93
Energy management software	PowerVision/CIR-ENERGY	48
Energy manager with powerStudio and built-in web server	EDS	45
Expansion modules for CVM-A and CVM-B	M-CVM-AB	24
Fast discharging resistors	RD	123
Filter for elevators	LCL-TH	146
Filter for PWM	SINUS	146
Filter reactors for power converters (network side)	LR	145
Fixed capacitors with automatic protection 50 Hz	CSB-A	128
Fixed capacitors with rejection reactance of $p = 7\%$	OPTIM FRF	136
Fixed capacitors with rejection reactance of $p = 7\%$	OPTIM FRM	136
Flexible Clamps	FLEX	51
Flexible sensors for CVM-C10-FLEX	FLEX-MAG	25
Frecuency transducers, Narrow section	CFE	56
Frequency transducers	CF	57
Frequencymeters	HC / HM / HZC / HLC	72
Frequencymeters	HC / HM / HZC / HLC	72
Full earth leakage and circuit breaker reclosing and protection unit, panel	WRGU-10-MTT	107
Gateway for DataBox platform	SBOX	48
Harmonic filters for power converters	LCL	146
Hour run meters	CH	78
Hybrid absorption filters	FAR-Q	147
Impulse and contact centralisers	LM	45
Impulse collection with communication	ReadWatt	46
Impulse collection with communication	ReadWatt	85
Indirect earth contact simulator	GETEST	113
Insulation resistance meter	MEG-1000	78
IP 54 covers for CLZ-FP	TCLZ	120

GENERAL INDEX by Designation alphabetical order

DESIGNATION	TYPE	PAGE
Kits for electrification	FV-ISLAND	165
maximeter ammeters	EMC	71
maximeter ammeters	MC / MMC / EMC	71
Maximum demand control devices	MDC	46
Measuring transformers encapsulated in resin	TRM	40
Megaohmmeters	MD	113
Meters for managing multiple supplies	CirCAMP	90
Microohmmeter	MH	113
Monitoring relay for offline insulation	IMD-2R	109
Motorized circuit breaker for currents exceeding than 63 A	MT-FDE	106
Motorized circuit breakers (up to 63 A)	RECmaxMP	106
Motorized circuit breakers for overcurrent and earth leakage protection with reclosing by differential relay	MCB	104
Motorized circuit breakers, up to 63 A	RECmaxP	107
Moving coil ammeters	BC / BM	67
Moving coil ammeters	BC / BM / CBC	67
Moving coil ammeters	CBC	67
Moving coil voltmeters	BC / BM	68
Moving coil voltmeters	BC / BM / CBC	68
Moving coil voltmeters	CBC	68
Moving Iron Miliammeters and Ammeter	CEC	62
Moving Iron Miliammeters and Ammeter	EC / EM / EZC	62
Moving Iron Miliammeters and Ammeter	EC / EM / EZC / CEC	62
Moving Iron Voltmeters	CEC	65
Moving Iron Voltmeters	EC / EM / EZC	65
Moving Iron Voltmeters	EC / EM / EZC / CEC	65
Narrow section transducers	CVE/CCE/CFE	56
Ohm, aislam, proceso, Transducers	Temp	57
On-grid Kits for instantaneous self-consumption in installations	Kits FV	162
Optical reader	LOC	85
Other accessories	CONNEX	158
Outdoor slow charging posts - mode 1, 2 and 3	URBAN	156
Overcurrent tripping relay with self-reclosing system	RRM	107
Pedestal for RVE-WB and eHome	PD	158
Phase sequence indicators	CUC	77
Phase sequence indicators	UC	77
Phasemeters	FEMC / FETC	75
Phasemeters	FEMC / FETC / FMZ / FTC / PIC	75
Phasemeters	FMZ / FTC	75
Phasemeters	PIC	75
Photovoltaic monitoring	TH-DG	46
Photovoltaic monitoring datalogger	PV-Monitor	163
Pinzas amperimétricas alta tensión	PI-23	114
Plataforma cloud	Databox	48
Portable clamp meter	MyCLAMP	85
Portable power analyzer with recording of quality events and transients Calibration Certificate (IEC 61000-4-30 Ed.2) Class A	MYeBOX-A	50
Portable power analyzer with recording of quality events and transients in accordance with (IEC 61000-4-30 Ed.2) Class A	MYeBOX	50
Power analyzer, three-phase DIN rail	CVM-NET	26
Power analyzer, 4 analyzers in a single unit, DIN rail	CVM-NET4	26
Power analyzer, colour display, panel mounted	CVM-B	24
Power analyzer, panel mounted 96 x96	CVM-C10	25
Power analyzer, panel mounted 96x96	CVM-C5	25

GENERAL INDEX by Designation alphabetical order

DESIGNATION	TYPE	PAGE
Power analyzer, three-phase DIN rail	CVM-MINI	26
Power capacitor with circuit breaker	CLP	130
Power capacitors for harmonic filtering (for FR)	CFB	125
Power capacitors for harmonics filters with static switching operation of the FRE series	CFB-6B	127
Power capacitors for LV	CQ	128
Power capacitors for LV	CSB	124
Power capacitors for LV	CV	128
Power capacitors for LV dual voltage	CSB-2V	124
Power capacitors with circuit breaker protection	CSB-M	129
Power capacitors with fuse protection	CSB-F	129
Power Factor & Cos ϕ transducer	CPF / CCOS	57
Power factor regulator 2 step, IP 00	computer two	118
Power factor regulators	computer Max P&P	118
Power factor regulators for static switching	computer Max-f	119
Power factor regulators for static switching	Computer SMART III-Fast	119
Power factor relay 1 step, IP 00	computer one	118
Power factor relay 1 step. din rail	DIR2	118
Power Factor transducer	CPF	57
Power quality analyzer	VLOG	52
Power quality analyzers, colour display, panel mounted	CVM-A	24
Power quality analyzers, colour display, panel mounted	CVM-A	29
Power Quality Single-Phase Analyzers	CAVA	52
Power transducer	CW / CY	57
Prepayment energy meters	CIRWATT P	84
Prepayment system	RVE-CARD	158
PRIME PLC Concentrator	COMPACT DC	84
Process indicators	BC / BM / ZC	69
Programmable earth leakage relay, 2 modules with display and static prealarm output	RGU-2	97
Protection box for single-phase charging points	COFRET	158
Protection relays and earth leakage reclosing, Type A ultra-immunised with built-in transformer	WRU-10RAL	103
Protection transformers encapsulated in resin	TRP	111
Protection vatmeters	PGR	76
Public lighting control system	CirLAMP	46
RCCB Type B	IDB-4	99
RCCB with self-reclosing system, type A	REC3	103
Reactive power transducer	CY	57
Reactors III for detuned static filters	RBX	126
Reactors III for detuned static filters	RX	126
Reactors III for detuned static filters	RX / RBX	126
Reactors III for detuned static filters with FRE static switching	RE-RBE	127
Reclosing earth leakage relay for motorized circuit breakers	RGU-10 MT	105
Reclosing protection relays and earth leakage reclosing with WGC external transformer	RGU-10 RAL	103
Relay tester	CR	113
Relay Type B built-in earth leakage current transformer	WGB-35-TB	99
Repeater for amplification of the PLC signal for the PRIME system	CIRWATT-repeater	84
Self-reclosing earth leakage really with power analyzer functions, transformers included	RECmax-CVM	104
Self-reclosing earth leakage relay with circuit breaker, used with an external earth leakage transformer	RECmaxLPD	105
Semi-fast hybrid automatic capacitor banks with phase-by-phase compensation for unbalanced networks	OPTIM HYB	135
Sensor for dynamic control of charging power	CirBEON	158
Sets of 3 current transformers for energy meters	kit3-TRMC210	39
Sets of 3 current transformers for energy meters	kit3-TRMC400	39
Shunts	SH	41

GENERAL INDEX by Designation alphabetical order

DESIGNATION	TYPE	PAGE
Single-phase and three-phase energy meters	CEM	91
Single-phase and three-phase energy meters	CEM	92
Single-phase energy meter	CIRWATT B II	83
Single-phase energy meter with basic analyser parameters	CEM-6	26
Single-phase energy meters with PLC system (measuring, load profiling, multi configurable billing calendar)	CIRWATT B II PRIME	84
Single-phase MV power capacitors (indoor and outdoor use)	CHV-M	149
Single-phase tubular power capacitor	CLZ-FP-M	120
Single-post solar canopy kits	PVS	164
Software for energy meters	PowerWat	85
Solar canopy kits	PV	164
Split three-phase current transformers	SC3	30
Split three-phase current transformers	SC3	37
Split-core earth leakage transformers/core balanced	TP-WG	97
Station with 4 programmable earth leakage relays, 4 modules with display and a configurable prealarm output.	CBS-4	98
Station with 8 current relays, display and RS-485 communications	CDR	109
String monitoring supervision devices	TRH	163
Synchronization equipment	SynchroMAX	77
Synchrosopes, 50 Hz	SMC / STC	77
Third harmonic blocking filter for 50 Hz network	FB3	147
Three-phase contactor for MV capacitors	LVC	151
Three-phase current transformers	MC3	37
Three-phase energy meters (Measuring, load profiling, multi configurable billing calendar)	CIRWATT B III	83
Three-phase energy meters with PLC system (measuring, load profiling, multi configurable billing calendar)	CIRWATT B III PRIME	84
Three-phase energy meters, external current transformer	EDMk	91
Three-phase MV power capacitors	CHV-T	150
Three-phase power factor regulators. Regulation, measurement, leakage control and communications	computer Smart III	118
Three-phase tubular power capacitor, 60 Hz	CLZ-FP24-60 HD	122
Three-phase tubular power capacitor, 60 Hz	CLZ-FP60-60 HD	123
Transducer Voltage	CV	56
Transformador de medida de tensión	VT	42
Transformador elevador	TE	42
Transformador sumador	TSR	42
Transformer with built-in earth leakage relay, Type A.	WGBU	98
Triple scale single-phase efficient transformers	MC1	37
Tubular power capacitor	CLZ-FP23 HD	120
Tubular power capacitor	CLZ-FP48 HD	121
Type A ultra-immunised earth leakage relay with built-in transformer	WRU	98
Varmeters	YMC / YTC	73
Voltage detector relays (AC), DIN rail	RV	109
Voltage transducers, Narrow section	CVE	56
Wattmeters	WMC / WTC	73
Wattmeters and varmeters	WMC / WTC / YMC / YTC	73
Wireless converters and probes	AIR	47

INDEX BY CODE

Code	Page	Code	Page	Code	Page	Code	Page	Code	Page
[C] E20001.	84	[C] E6P240.	164	[*] M10217	62	[1] M102VP	63	[*] M102YV	63
[C] E4K394.	165	[C] E6P242.	164	[*] M10218	62	[1] M102VQ	63	[2] M102YW	63
[C] E4K4C5.	165	[C] E6P404.	164	[*] M10219	62	[1] M102VR	63	[*] M102Z2	63
[C] E4K5D6.	165	[C] E6P406.	164	[*] M1021A	62	[1] M102VS	63	[*] M102Z3	63
[C] E4K6E7.	165	[C] E6P408.	164	[*] M10220	62	[1] M102VT	63	[*] M102Z4	63
[C] E4K7F8.	165	[C] E6P412.	164	[*] M10222	62	[1] M102VU	63	[*] M102Z5	63
[C] E4K8G8.	165	[C] E6P416.	164	[*] M10223	62	[1] M102VV	63	[*] M102Z6	63
[C] E4K9H9.	165	[C] E6P420.	164	[*] M10224	62	[1] M102VW	63	[*] M102Z7	63
[C] E51001.	162	[C] E6P424.	164	[*] M10225	62	[*] M102X2	63	[*] M102Z8	63
[C] E51002.	162	[C] E6P428.	164	[*] M10226	62	[*] M102X3	63	[*] M102Z9	63
[C] E52001.	162	[C] E6P432.	164	[*] M10227	62	[*] M102X4	63	[*] M102ZA	63
[2] E5K011.	162	[C] E6P436.	164	[*] M10228	62	[*] M102X5	63	[*] M102ZB	63
[2] E5K012.	162	[C] E6P440.	164	[*] M10229	62	[*] M102X6	63	[*] M102ZC	63
[2] E5K021.	162	[C] E6P444.	164	[*] M1022A	62	[*] M102X7	63	[*] M102ZD	63
[2] E5K022.	162	[*] E80005.	163	[*] M1022B	62	[*] M102X8	63	[*] M102ZE	63
[2] E5K031.	162	[*] E80010.	163	[*] M1022C	62	[*] M102X9	63	[*] M102ZF	63
[2] E5K032.	162	[*] E80011.	163	[*] M10230	62	[*] M102XA	63	[*] M102ZG	63
[2] E5K033.	162	[*] E80012.	163	[*] M10232	62	[*] M102XB	63	[*] M102ZH	63
[2] E5K034.	162	[*] E80013.	163	[*] M10233	62	[*] M102XC	63	[*] M102ZJ	63
[2] E5K037.	162	[2] E8100*.	163	[*] M10234	62	[*] M102XD	63	[2] M102ZK	63
[2] E5K038.	162	[2] E8110*.	163	[*] M10235	62	[*] M102XE	63	[*] M102ZL	63
[2] E5K039.	162	[1] EX0056.	163	[*] M10236	62	[*] M102XF	63	[*] M102ZM	63
[2] E5K043.	162	[*] EX0095.	163	[1] M10237	62	[*] M102XG	63	[*] M102ZN	63
[2] E5K044.	162	[1] M10111	62	[*] M10238	62	[*] M102XH	63	[*] M102ZP	63
[2] E5K051.	162	[1] M10112	62	[*] M10239	62	[*] M102XJ	63	[*] M102ZQ	63
[2] E5K052.	162	[1] M10114	62	[*] M1023A	62	[*] M102XK	63	[*] M102ZR	63
[2] E5K054.	162	[1] M10115	62	[1] M1023B	62	[*] M102XL	63	[*] M102ZS	63
[2] E5K061.	162	[1] M10116	62	[*] M1023C	62	[*] M102XM	63	[*] M102ZT	63
[2] E5K062.	162	[1] M10117	62	[3] M10240	62	[*] M102XN	63	[*] M102ZU	63
[2] E5K071.	162	[1] M10118	62	[3] M10242	62	[*] M102XP	63	[*] M102ZV	63
[2] E5K072.	162	[1] M10121	62	[3] M10243	62	[*] M102XQ	63	[*] M102ZW	63
[2] E5K081.	162	[1] M10122	62	[3] M10244	62	[*] M102XR	63	[1] M10410	65
[2] E5K082.	162	[1] M10124	62	[3] M10245	62	[*] M102XS	63	[*] M10415	65
[2] E5K123.	162	[1] M10125	62	[3] M10246	62	[*] M102XT	63	[*] M10416	65
[2] E5K130.	162	[1] M10126	62	[3] M10247	62	[*] M102XU	63	[1] M10417	65
[2] E5K131.	162	[1] M10127	62	[3] M10248	62	[*] M102XV	63	[*] M10418	65
[2] E5K132.	162	[1] M10128	62	[3] M10249	62	[*] M102XW	63	[1] M10419	65
[2] E5K133.	162	[1] M10131	62	[3] M1024A	62	[*] M102Y2	63	[*] M10420	65
[2] E5K134.	162	[1] M10132	62	[3] M1024B	62	[*] M102Y3	63	[*] M10425	65
[2] E5K200.	162	[1] M10134	62	[3] M1024C	62	[*] M102Y4	63	[*] M10426	65
[2] E5K210.	162	[1] M10135	62	[*] M10250	62	[*] M102Y5	63	[1] M10427	65
[2] E5K220.	162	[1] M10136	62	[1] M10252	62	[*] M102Y6	63	[*] M10428	65
[2] E5K230.	162	[1] M10137	62	[*] M10253	62	[*] M102Y7	63	[*] M10429	65
[C] E6P102.	164	[1] M10138	62	[*] M10254	62	[*] M102Y8	63	[*] M10430	65
[C] E6P120.	164	[1] M10141	62	[1] M10255	62	[*] M102Y9	63	[*] M10435	65
[C] E6P202.	164	[1] M10142	62	[*] M10256	62	[*] M102YA	63	[*] M10436	65
[C] E6P203.	164	[1] M10144	62	[*] M10257	62	[*] M102YB	63	[1] M10437	65
[C] E6P204.	164	[1] M10145	62	[*] M10258	62	[*] M102YC	63	[*] M10438	65
[C] E6P206.	164	[1] M10146	62	[3] M10259	62	[*] M102YD	63	[1] M10439	65
[C] E6P208.	164	[1] M10147	62	[3] M1025A	62	[*] M102YE	63	[3] M10440	65
[C] E6P210.	164	[1] M10148	62	[*] M102V9	63	[*] M102YF	63	[3] M10445	65
[C] E6P212.	164	[1] M10151	62	[*] M102VA	63	[*] M102YG	63	[3] M10446	65
[C] E6P216.	164	[1] M10152	62	[*] M102VB	63	[*] M102YH	63	[3] M10447	65
[C] E6P218.	164	[1] M10154	62	[*] M102VC	63	[*] M102YJ	63	[3] M10448	65
[C] E6P220.	164	[1] M10155	62	[*] M102VD	63	[*] M102YK	63	[3] M10449	65
[C] E6P222.	164	[1] M10156	62	[*] M102VE	63	[*] M102YL	63	[1] M10450	65
[C] E6P224.	164	[1] M10157	62	[*] M102VF	63	[*] M102YM	63	[*] M10456	65
[C] E6P226.	164	[1] M10158	62	[1] M102VG	63	[*] M102YN	63	[*] M10458	65
[C] E6P228.	164	[*] M10210	62	[*] M102VH	63	[*] M102YP	63	[1] M104V1	66
[C] E6P230.	164	[*] M10212	62	[*] M102VJ	63	[*] M102YQ	63	[1] M104V2	66
[C] E6P232.	164	[*] M10213	62	[*] M102VK	63	[*] M102YR	63	[1] M104V3	66
[C] E6P234.	164	[*] M10214	62	[*] M102VL	63	[*] M102YS	63	[1] M104V4	66
[C] E6P236.	164	[*] M10215	62	[*] M102VM	63	[*] M102YT	63	[1] M104V5	66
[C] E6P238.	164	[*] M10216	62	[*] M102VN	63	[*] M102YU	63	[1] M104V6	66

Code	Page	Code	Page	Code	Page	Code	Page	
[1] M104V7	66 [*] M105YP	63	[*] M109Y6	63	[3] M11440	67	[1] M114ZC	67
[1] M104V8	66 [*] M105YQ	63	[*] M109Y7	63	[3] M11440	67	[1] M114ZE	67
[1] M104X1	66 [*] M105YR	63	[*] M109Y8	63	[3] M11442	67	[1] M114ZF	67
[1] M104X2	66 [*] M105YS	63	[*] M109Y9	63	[3] M11442	67	[1] M114ZG	67
[1] M104X3	66 [*] M105YT	63	[*] M109YA	63	[3] M11443	67	[1] M114ZH	67
[1] M104X4	66 [*] M105YU	63	[*] M109YB	63	[3] M11443	67	[1] M114ZJ	67
[1] M104X5	66 [*] M105YV	63	[2] M109YC	63	[3] M11446	67	[1] M114ZL	67
[1] M104X6	66 [*] M105YW	63	[*] M109YD	63	[3] M11446	67	[1] M114ZP	67
[1] M104X7	66 [*] M10625	65	[2] M109YE	63	[3] M11449	67	[1] M114ZR	67
[1] M104X8	66 [*] M10626	65	[2] M109YF	63	[3] M11449	67	[1] M114ZT	67
[1] M104Y1	66 [*] M10627	65	[2] M109YG	63	[3] M1144A	67	[3] M11711	68
[1] M104Y2	66 [*] M10628	65	[2] M109YH	63	[3] M1144A	67	[*] M11714	68
[1] M104Y3	66 [*] M10629	65	[*] M109YJ	63	[3] M11450	67	[*] M11716	68
[1] M104Y4	66 [2] M10632	65	[*] M109YK	63	[2] M11450	67	[*] M11718	68
[1] M104Y5	66 [3] M10635	65	[*] M109YL	63	[3] M11452	67	[3] M11719	68
[1] M104Y6	66 [*] M10636	65	[*] M109YM	63	[2] M11452	67	[3] M1171A	68
[1] M104Y7	66 [3] M10637	65	[*] M109YN	63	[*] M11453	67	[3] M1171B	68
[1] M104Y8	66 [*] M10638	65	[*] M109YP	63	[2] M11453	67	[3] M1171D	68
[1] M104Z1	66 [3] M10639	65	[*] M109YQ	63	[3] M11456	67	[3] M1171E	68
[1] M104Z2	66 [3] M10725	65	[2] M109YR	63	[2] M11456	67	[3] M1171F	68
[1] M104Z3	66 [*] M10726	65	[*] M109YS	63	[*] M11459	67	[1] M11721	68
[1] M104Z4	66 [*] M10727	65	[*] M109YT	63	[2] M11459	67	[*] M11724	68
[1] M104Z5	66 [*] M10728	65	[*] M109YU	63	[1] M114V9	67	[*] M11726	68
[1] M104Z6	66 [2] M10729	65	[*] M109YV	63	[1] M114VA	67	[*] M11728	68
[1] M104Z7	66 [3] M10735	65	[*] M109YW	63	[1] M114VB	67	[*] M11729	68
[1] M104Z8	66 [*] M10736	65	[2] M11038	65	[1] M114VC	67	[*] M1172A	68
[*] M10521	62 [3] M10737	65	[3] M11125	65	[1] M114VE	67	[*] M1172B	68
[*] M10531	62 [*] M10738	65	[3] M11128	65	[1] M114VF	67	[*] M1172D	68
[*] M105X9	63 [3] M10739	65	[3] M11135	65	[1] M114VG	67	[*] M1172E	68
[*] M105XA	63 [3] M10920	62	[3] M11138	65	[1] M114VH	67	[1] M1172F	68
[*] M105XB	63 [3] M10930	62	[*] M11410	67	[1] M114VJ	67	[1] M11731	68
[*] M105XC	63 [*] M109X2	63	[1] M11410	67	[1] M114VL	67	[*] M11734	68
[*] M105XD	63 [*] M109X3	63	[3] M11412	67	[1] M114VP	67	[*] M11736	68
[2] M105XE	63 [*] M109X4	63	[2] M11412	67	[1] M114VR	67	[*] M11738	68
[*] M105XF	63 [*] M109X5	63	[3] M11413	67	[1] M114VT	67	[*] M11739	68
[*] M105XG	63 [*] M109X6	63	[2] M11413	67	[*] M114X9	67	[*] M1173A	68
[*] M105XH	63 [*] M109X7	63	[*] M11416	67	[1] M114XA	67	[*] M1173B	68
[*] M105XJ	63 [2] M109X8	63	[2] M11416	67	[1] M114XB	67	[*] M1173D	68
[*] M105XK	63 [2] M109X9	63	[3] M11419	67	[*] M114XC	67	[1] M1173E	68
[*] M105XL	63 [*] M109XA	63	[2] M11419	67	[1] M114XE	67	[1] M1173F	68
[*] M105XM	63 [*] M109XB	63	[*] M11420	67	[*] M114XF	67	[3] M11741	68
[*] M105XN	63 [2] M109XC	63	[*] M11420	67	[1] M114XG	67	[3] M11744	68
[*] M105XP	63 [*] M109XD	63	[*] M11422	67	[1] M114XH	67	[3] M11746	68
[*] M105XQ	63 [2] M109XE	63	[2] M11422	67	[*] M114XJ	67	[3] M11748	68
[*] M105XR	63 [2] M109XF	63	[*] M11423	67	[*] M114XL	67	[3] M11749	68
[*] M105XS	63 [2] M109XG	63	[*] M11423	67	[*] M114XP	67	[3] M1174A	68
[*] M105XT	63 [*] M109XH	63	[*] M11426	67	[1] M114XR	67	[3] M1174B	68
[*] M105XU	63 [2] M109XJ	63	[2] M11426	67	[1] M114XT	67	[3] M1174D	68
[*] M105XV	63 [*] M109XK	63	[*] M11429	67	[*] M114Y9	67	[3] M1174E	68
[*] M105XW	63 [2] M109XL	63	[2] M11429	67	[1] M114YA	67	[3] M1174F	68
[*] M105Y9	63 [2] M109XM	63	[3] M1142A	67	[1] M114YB	67	[3] M11754	68
[2] M105YA	63 [*] M109XN	63	[2] M1142A	67	[*] M114YC	67	[3] M11755	68
[*] M105YB	63 [2] M109XP	63	[*] M11430	67	[1] M114YE	67	[3] M11756	68
[*] M105YC	63 [*] M109XQ	63	[*] M11430	67	[*] M114YF	67	[3] M11757	68
[2] M105YD	63 [*] M109XR	63	[3] M11432	67	[1] M114YG	67	[*] M11758	68
[*] M105YE	63 [2] M109XS	63	[2] M11432	67	[1] M114YH	67	[3] M1175F	68
[*] M105YF	63 [*] M109XT	63	[3] M11433	67	[1] M114YJ	67	[*] M11811	69
[*] M105YG	63 [2] M109XU	63	[2] M11433	67	[*] M114YL	67	[1] M11812	69
[*] M105YH	63 [2] M109XV	63	[*] M11436	67	[1] M114YP	67	[*] M11813	68
[*] M105YJ	63 [*] M109XW	63	[2] M11436	67	[1] M114YR	67	[*] M11813	69
[*] M105YK	63 [2] M109Y2	63	[3] M11439	67	[1] M114YT	67	[*] M11821	69
[*] M105YL	63 [*] M109Y3	63	[2] M11439	67	[1] M114Z9	67	[1] M11822	69
[*] M105YM	63 [*] M109Y4	63	[3] M1143A	67	[1] M114ZA	67	[*] M11823	68
[*] M105YN	63 [*] M109Y5	63	[2] M1143A	67	[1] M114ZB	67	[*] M11823	69

INDEX by CODE

Code	Page	Code	Page	Code	Page	Code	Page	Code	Page
[*] M11831	69	[1] M12531	69	[1] M130J9	74	[1] M132JV	74	[4] M13535	75
[1] M11832	69	[1] M12533	69	[1] M130JC	74	[1] M132JW	74	[4] M13536	75
[*] M11833	68	[1] M12540	69	[1] M130JE	74	[1] M132K9	74	[4] M13537	75
[*] M11833	69	[1] M12541	69	[1] M130JF	74	[1] M132KB	74	[4] M13538	75
[3] M11841	69	[1] M12543	69	[1] M130JH	74	[1] M132KC	74	[4] M1353C	75
[3] M11842	69	[*] M12622	71	[1] M130JJ	74	[1] M132KE	74	[4] M1353D	75
[3] M11843	68	[*] M12632	71	[1] M130JK	74	[1] M132KF	74	[4] M1353E	75
[3] M11843	69	[3] M12642	71	[1] M130JL	74	[1] M132KH	74	[4] M1353F	75
[3] M11851	69	[*] M12651	71	[1] M130JP	74	[1] M132KJ	74	[4] M1353G	75
[3] M11852	69	[1] M126VC	71	[1] M130JR	74	[1] M132KK	74	[4] M1353H	75
[3] M11853	69	[1] M126VF	71	[1] M130JS	74	[1] M132KL	74	[4] M13541	75
[1] M118V1	69	[1] M126VH	71	[1] M130JU	74	[1] M132KP	74	[4] M13542	75
[1] M118V2	69	[1] M126VJ	71	[1] M130JV	74	[1] M132KR	74	[4] M13543	75
[1] M118V3	69	[1] M126VK	71	[1] M130JW	74	[1] M132KS	74	[4] M13544	75
[3] M118X1	69	[1] M126VL	71	[1] M130K9	74	[1] M132KU	74	[4] M13545	75
[3] M118X2	69	[1] M126VM	71	[1] M130KB	74	[1] M132KV	74	[4] M13546	75
[3] M118X3	69	[1] M126VN	71	[1] M130KC	74	[1] M132KW	74	[4] M13547	75
[3] M118Y1	69	[1] M126VP	71	[1] M130KE	74	[1] M132L9	74	[4] M13548	75
[3] M118Y2	69	[1] M126VR	71	[1] M130KF	74	[1] M132LB	74	[4] M1354C	75
[3] M118Y3	69	[1] M126VS	71	[1] M130KH	74	[1] M132LC	74	[4] M1354D	75
[3] M118Z1	69	[*] M126XC	71	[1] M130KJ	74	[1] M132LE	74	[4] M1354E	75
[3] M118Z2	69	[*] M126XF	71	[1] M130KK	74	[1] M132LF	74	[4] M1354F	75
[3] M118Z3	69	[*] M126XH	71	[1] M130KL	74	[1] M132LH	74	[4] M1354G	75
[1] M12211	71	[*] M126XJ	71	[1] M130KP	74	[1] M132LJ	74	[4] M1354H	75
[*] M12221	71	[*] M126XK	71	[1] M130KR	74	[1] M132LK	74	[4] M13631	75
[*] M12231	71	[*] M126XL	71	[1] M130KS	74	[1] M132LL	74	[4] M13632	75
[3] M12241	71	[*] M126XM	71	[1] M130KU	74	[1] M132LP	74	[4] M13633	75
[*] M122XC	71	[*] M126XN	71	[1] M130KV	74	[1] M132LR	74	[4] M13634	75
[*] M122XF	71	[*] M126XP	71	[1] M130KW	74	[1] M132LS	74	[4] M13635	75
[*] M122XH	71	[*] M126XR	71	[1] M130L9	74	[1] M132LU	74	[4] M13636	75
[*] M122XJ	71	[*] M126XS	71	[1] M130LB	74	[1] M132LV	74	[4] M13637	75
[*] M122XK	71	[*] M126YC	71	[1] M130LC	74	[1] M132LW	74	[4] M13638	75
[*] M122XL	71	[*] M126YF	71	[1] M130LE	74	[1] M13431	75	[*] M13639	75
[*] M122XM	71	[*] M126YH	71	[1] M130LF	74	[1] M13432	75	[4] M13641	75
[*] M122XN	71	[*] M126YJ	71	[1] M130LH	74	[1] M13433	75	[4] M13642	75
[*] M122XP	71	[*] M126YK	71	[1] M130LJ	74	[1] M13434	75	[4] M13643	75
[*] M122XR	71	[3] M126YL	71	[1] M130LK	74	[1] M13435	75	[4] M13644	75
[*] M122XS	71	[*] M126YM	71	[1] M130LL	74	[1] M13436	75	[4] M13645	75
[*] M122YC	71	[*] M126YN	71	[1] M130LP	74	[1] M13437	75	[4] M13646	75
[*] M122YF	71	[*] M126YP	71	[1] M130LR	74	[1] M13438	75	[4] M13647	75
[*] M122YH	71	[*] M126YR	71	[1] M130LS	74	[1] M1343C	75	[4] M13648	75
[*] M122YJ	71	[*] M126YS	71	[1] M130LU	74	[1] M1343D	75	[4] M13649	75
[*] M122YK	71	[*] M12711	72	[1] M130LV	74	[3] M1343E	75	[1] M13721	77
[3] M122YL	71	[*] M12721	72	[1] M130LW	74	[*] M1343F	75	[1] M13726	77
[3] M122YM	71	[*] M12731	72	[3] M13231	73	[1] M1343G	75	[1] M13731	77
[*] M122YN	71	[3] M12732	77	[3] M13232	73	[1] M1343H	75	[1] M13736	77
[*] M122YP	71	[3] M12741	72	[3] M13233	73	[3] M13441	75	[3] M13754	77
[*] M122YR	71	[4] M12742	77	[2] M13234	73	[3] M13442	75	[*] M13755	77
[*] M122YS	71	[2] M12751	72	[3] M13241	73	[3] M13443	75	[3] M13831	77
[1] M122ZC	71	[1] M12831	72	[3] M13242	73	[3] M13444	75	[3] M13832	77
[*] M122ZF	71	[1] M12841	72	[3] M13243	73	[3] M13445	75	[3] M13833	77
[*] M122ZH	71	[*] M12921	72	[3] M13244	73	[3] M13446	75	[3] M13834	77
[*] M122ZJ	71	[*] M12931	72	[1] M132J9	74	[3] M13447	75	[3] M13835	77
[*] M122ZK	71	[*] M12932	77	[1] M132JC	74	[3] M13448	75	[4] M13841	77
[1] M122ZL	71	[3] M12941	72	[1] M132JE	74	[3] M1344C	75	[4] M13842	77
[1] M122ZM	71	[4] M12942	77	[1] M132JF	74	[3] M1344D	75	[4] M13843	77
[1] M122ZN	71	[*] M13031	73	[1] M132JH	74	[3] M1344E	75	[*] M13844	77
[1] M122ZP	71	[*] M13032	73	[1] M132JJ	74	[3] M1344F	75	[4] M13845	77
[1] M122ZR	71	[*] M13033	73	[1] M132JK	74	[3] M1344G	75	[3] M14431	77
[1] M122ZS	71	[3] M13034	73	[1] M132JL	74	[3] M1344H	75	[3] M14432	77
[1] M12520	69	[4] M13041	73	[1] M132JP	74	[4] M13531	75	[3] M14433	77
[1] M12521	69	[4] M13042	73	[1] M132JR	74	[4] M13532	75	[3] M14434	77
[1] M12523	69	[4] M13043	73	[1] M132JS	74	[4] M13533	75	[*] M14435	77
[1] M12530	69	[3] M13044	73	[1] M132JU	74	[4] M13534	75	[3] M14436	77

Code	Page	Code	Page	Code	Page	Code	Page	Code	Page
[*] M14437	77	[*] M20224.	54	[1] M25352.	57	[*] M54B31.	26	[*] M62001.	47
[3] M14438	77	[*] M20225.	54	[1] M25361.	57	[*]	26	[*] M62001.	92
[4] M14441	77	[*] M20226.	54	[1] M25362.	57	M54B310000V00		[*] M62002.	30
[4] M14442	77	[*] M20227.	54	[3] M25511.	56	[*] M55782.	26	[*] M62002.	47
[4] M14443	77	[*] M2022A.	54	[3] M25521.	56	[*] M55853.	25	[*] M62002.	92
[4] M14444	77	[*] M20419.	55	[3] M25531.	57	[*] M55873.	25	[*] M62003.	30
[4] M14445	77	[*] M2043F.	55	[1] M25532.	57	[C]	25	[*] M62003.	47
[4] M14446	77	[*] M20901.	53	[*] M25610.	57	M558730000V00		[*] M62003.	92
[4] M14447	77	[*] M20911.	53	[1] M25612.	57	[*] M55884.	25	[*] M62004.	30
[4] M14448	77	[*] M20921.	53	[3] M25631.	57	[*] M55885.	25	[*] M62004.	47
[*] M14624	77	[*] M20931.	53	[1] M25641.	57	[*] M55894.	25	[*] M62004.	92
[*] M14625	77	[*] M20941.	53	[1] M25642.	57	[*]	25	[*] M62005.	30
[*] M14634	77	[*] M20951.	53	[1] M25651.	57	M558940000V00		[*] M62005.	47
[4] M14635	77	[1] M22021.	55	[*] M25652.	57	[*]	25	[*] M62005.	92
[4] M14721	76	[1] M22022.	55	[4] M29911.	54	M558950000V00		[1] M62006.	30
[4] M14722	76	[1] M22023.	55	[4] M29912.	54	[*] M55911.	25	[1] M62006.	47
[4] M14723	76	[1] M22024.	55	[*] M29913.	54	[*] M55921.	25	[1] M62006.	92
[4] M14724	76	[1] M22025.	55	[*] M29914.	54	[*]	25	[*] M62121.	30
[*] M14810	62	[1] M22026.	55	[3] M30300.	92	M559210000V00		[*] M62121.	46
[3] M14820	65	[1] M22027.	55	[3]	92	[*] M55942.	25	[*] M62121.	85
[3] M14821	65	[1] M22028.	55	M303000000D00		[*] M55963.	25	[*] M62121.	92
[3] M14822	65	[*] M25011.	56	[*] M30400.	92	[*] M56011.	24	[*] M62141.	30
[3] M14823	65	[3] M25021.	56	[3]	92	[*] M56111.	24	[*] M62141.	46
[3] M14824	65	[1] M25031.	56	M304000000D00		[*] M56311.	24	[*] M62141.	85
[3] M14825	65	[1] M25032.	56	[*] M31563.	45	[*] M56311.	29	[*] M62141.	92
[3] M14826	65	[1] M25041.	56	[*] M31565.	45	[*] M56E01.	24	[*] M62311.	46
[3] M14830	67	[1] M25051.	56	[*] M31566.	45	[*] M56E02.	24	[*] M62311.	85
[2] M14830	67	[1] M25052.	56	[*] M31567.	45	[*] M56E03.	24	[*] M62331.	46
[3] M14841	68	[1] M25061.	56	[*] M31751.	91	[*] M56E05.	24	[*] M62331.	85
[3] M14842	68	[1] M25062.	56	[*] M31781.	91	[*] M56E06.	24	[*] M63001.	46
[3] M14843	68	[*] M25111.	56	[*] M317C4.	91	[*] M56E07.	24	[C] M63002.	46
[3] M14844	68	[*] M25121.	56	[*] M52000.	26	[*] M56E08.	24	[C] M63011.	46
[3] M14845	68	[1] M25131.	56	[*] M52011.	26	[*] M56E09.	24	[C] M63021.	46
[3] M14846	68	[*] M25132.	56	[*] M52021.	26	[*] M56E0A.	24	[C] M63030.	46
[3] M14911	78	[*] M25141.	56	[*] M52031.	26	[*] M57010.	27	[*] M70111.	36
[3] M14921	78	[1] M25151.	56	[*] M52071.	26	[*] M57011.	27	[*] M70112.	36
[3] M14931	78	[*] M25152.	56	[*] M52081.	26	[*] M57020.	27	[*] M70113.	36
[3] M14951	78	[1] M25161.	56	[*]	26	[*] M57021.	27	[*] M70114.	36
[*] M15051	78	[1] M25162.	56	M520810000V00		[*] M57022.	27	[*] M70115.	36
[3] M15521	71	[1] M25211.	57	[*] M52091.	26	[*] M57023.	27	[*] M70116.	36
[3] M15531	71	[1] M25212.	57	[*] M520F1.	26	[*] M57024.	27	[*] M70117.	36
[3] M19921	79	[1] M25212.	57	[*] M520H1.	26	[*] M570A2.	27	[*] M70118.	36
[*] M19922	79	[1] M25222.	57	[*] M520J1.	26	[*] M570A3.	27	[*] M7011A.	36
[*] M19923	79	[1] M25222.	57	[*] M520L1.	26	[*] M570B1.	27	[*] M70121.	36
[1] M19941	79	[1] M25231.	57	[*] M54033.	30	[*] M570B2.	27	[*] M70122.	36
[1] M19942	79	[1] M25232.	57	[*] M54033.	46	[*] M570B3.	27	[*] M70123.	36
[1] M19942	79	[1] M25241.	57	[*] M54033.	85	[*] M5ZZ5T.	25	[*] M70124.	36
[1] M19943	79	[1] M25242.	57	[*] M54033.	92	[*] M5ZZ5U.	24	[*] M70125.	36
[1] M19944	79	[1] M25251.	57	[*] M54040.	30	[*] M5ZZ5V.	24	[*] M70126.	36
[1] M1ZZ52	79	[1] M25252.	57	[*] M54040.	46	[*] M5ZZF1.	26	[*] M70127.	36
[1] M1ZZ53	79	[1] M25261.	57	[*] M54040.	85	[*] M5ZZF1.	97	[*] M70128.	36
[1] M1ZZ54	79	[1] M25262.	57	[*] M54040.	92	[*] M5ZZF1.	98	[*] M7012A.	36
[1] M1ZZ55	79	[1] M25271.	57	[*] M54050.	30	[*] M61010.	45	[*] M7012B.	36
[*] M20210.	54	[1] M25272.	57	[*] M54050.	46	[*] M61012.	45	[3] M7012C.	36
[*] M20211.	54	[1] M25281.	57	[*] M54050.	85	[*] M61020.	45	[*] M7012D.	36
[1] M20212.	54	[1] M25282.	57	[*] M54050.	92	[C] M61022.	45	[*] M70131.	36
[*] M20213.	54	[1] M25311.	57	[*] M540A0.	30	[*] M610A1.	45	[*] M70132.	36
[1] M20214.	54	[1] M25312.	57	[*] M540A0.	46	[*] M610A2.	45	[*] M70133.	36
[1] M20215.	54	[1] M25321.	57	[*] M540A0.	85	[*] M61310.	46	[*] M70134.	36
[1] M20216.	54	[1] M25322.	57	[*] M540A0.	92	[*] M61410.	46	[*] M70135.	36
[1] M20217.	54	[1] M25331.	57	[*] M540B0.	30	[*] M61430.	46	[*] M70136.	36
[*] M20220.	54	[1] M25332.	57	[*] M540B0.	46	[*] M61920.	48	[*] M70137.	36
[*] M20221.	54	[1] M25341.	57	[*] M540B0.	85	[*] M61930.	48	[*] M70138.	36
[*] M20222.	54	[1] M25342.	57	[*] M540B0.	92	[*] M62001.	30	[*] M70141.	36
[*] M20223.	54	[1] M25351.	57	[*] M54B21.	26				

INDEX by CODE

Code	Page	Code	Page	Code	Page	Code	Page	Code	Page
[*] M70142.	36	[*] M70343.	34	[*] M70434.	35	[*] M70596.	38	[2] M71041.	58
[*] M70143.	36	[*] M70344.	34	[*] M70435.	35	[*] M70597.	38	[*] M71042.	58
[*] M70144.	36	[*] M70345.	34	[*] M70436.	35	[*] M70598.	38	[*] M71043.	58
[*] M70145.	36	[*] M70346.	34	[*] M70437.	35	[*] M70599.	38	[*] M71044.	58
[*] M70146.	36	[*] M70347.	34	[*] M70438.	35	[3] M7059A.	38	[*] M71045.	58
[*] M70147.	36	[*] M70348.	34	[*] M70439.	35	[C] M7059B.	38	[*] M71046.	58
[*] M70148.	36	[*] M70349.	34	[*] M70441.	35	[3] M705A2.	38	[*] M71047.	58
[*] M70149.	36	[*] M70361.	34	[*] M70442.	35	[3] M705A3.	38	[3] M71211.	41
[*] M7014A.	36	[*] M70362.	34	[*] M70443.	35	[*] M705A4.	38	[3] M71212.	41
[*] M70151.	36	[*] M70363.	34	[*] M70444.	35	[*] M705A6.	38	[3] M71213.	41
[*] M70152.	36	[*] M70364.	34	[*] M70445.	35	[*] M705A7.	38	[3] M71214.	41
[*] M70153.	36	[*] M70365.	34	[*] M70446.	35	[*] M705A8.	38	[3] M71215.	41
[*] M70154.	36	[*] M70366.	34	[*] M70447.	35	[*] M705A9.	38	[3] M71216.	41
[*] M70155.	36	[*] M70367.	34	[*] M7044B.	35	[*] M705B1.	38	[3] M71217.	41
[*] M70156.	36	[*] M70368.	34	[*] M7044C.	35	[3] M705B2.	38	[3] M71218.	41
[*] M70157.	36	[*] M70369.	34	[*] M70463.	35	[*] M705B3.	38	[3] M71221.	41
[3] M70158.	36	[*] M7036A.	34	[*] M70464.	35	[*] M705B5.	38	[3] M71222.	41
[3] M7015A.	36	[*] M7036B.	34	[*] M70465.	35	[*] M705B6.	38	[3] M71223.	41
[3] M7015B.	36	[*] M7036C.	34	[*] M70466.	35	[*] M705B7.	38	[3] M71224.	41
[3] M7015C.	36	[*] M70372.	34	[*] M70467.	35	[*] M705B8.	38	[3] M71225.	41
[3] M7015E.	36	[*] M70373.	34	[*] M70468.	35	[*] M705B9.	38	[3] M71226.	41
[3] M7015F.	36	[*] M70374.	34	[*] M70469.	35	[3] M705BA.	38	[*] M71227.	41
[3] M7015H.	36	[*] M70375.	34	[*] M7046A.	35	[3] M705BB.	38	[*] M71228.	41
[*] M70211.	58	[*] M70376.	34	[*] M70472.	35	[*] M70601.	37	[*] M71229.	41
[*] M70212.	58	[*] M70377.	34	[*] M70473.	35	[*] M70602.	37	[*] M7122A.	41
[*] M70213.	58	[*] M70378.	34	[*] M70474.	35	[*] M70603.	37	[*] M7122B.	41
[*] M70214.	58	[*] M70379.	34	[*] M70475.	35	[*] M70604.	37	[*] M7122C.	41
[*] M70215.	58	[*] M7037B.	34	[*] M70476.	35	[*] M70605.	37	[*] M7122D.	41
[*] M70216.	58	[*] M7037C.	34	[*] M70477.	35	[*] M70606.	37	[*] M7122E.	41
[*] M70217.	58	[*] M7037D.	34	[*] M70478.	35	[*] M70607.	37	[*] M7122F.	41
[*] M70218.	58	[*] M7037E.	34	[*] M70479.	35	[*] M70608.	37	[2] M7122N.	41
[*] M70221.	58	[*] M7037F.	34	[*] M7047C.	35	[C] M70609.	37	[*] M71231.	41
[*] M70222.	58	[*] M7037G.	34	[*] M70482.	35	[*] M70701.	42	[2] M71232.	41
[*] M70223.	58	[*] M7037H.	34	[*] M70483.	35	[*] M70702.	42	[*] M71233.	41
[*] M70224.	58	[*] M70381.	34	[*] M70484.	35	[*] M70703.	42	[*] M71234.	41
[*] M70311.	33	[*] M70382.	34	[*] M70485.	35	[*] M70704.	42	[*] M71235.	41
[*] M70312.	33	[*] M70383.	34	[*] M70486.	35	[1] M70811.	58	[*] M71236.	41
[*] M70313.	33	[*] M70384.	34	[*] M70487.	35	[*] M70812.	58	[*] M71237.	41
[*] M70314.	33	[*] M70385.	34	[*] M70488.	35	[*] M70813.	58	[*] M71238.	41
[*] M70315.	33	[*] M70386.	34	[*] M7048B.	35	[*] M70814.	58	[*] M71239.	41
[*] M70316.	33	[*] M70387.	34	[*] M7048C.	35	[*] M70815.	58	[*] M7123A.	41
[*] M70317.	33	[*] M70388.	34	[*] M70541.	38	[*] M70816.	58	[*] M7123B.	41
[*] M70318.	33	[*] M7038B.	34	[*] M70542.	38	[*] M70817.	58	[*] M7123C.	41
[*] M70319.	33	[*] M7038C.	34	[*] M70543.	38	[*] M70821.	58	[*] M7123D.	41
[*] M70321.	33	[*] M7038D.	34	[*] M70544.	38	[*] M70822.	58	[2] M7123E.	41
[*] M70322.	33	[*] M703B1.	34	[*] M70545.	38	[*] M70823.	58	[2] M7123F.	41
[*] M70323.	33	[*] M703B2.	34	[*] M70546.	38	[*] M70824.	58	[*] M7123G.	41
[*] M70324.	33	[*] M703B3.	34	[*] M70547.	38	[1] M70831.	58	[3] M7123H.	41
[*] M70325.	33	[*] M703B4.	34	[*] M70548.	38	[1] M70832.	58	[*] M7123J.	41
[*] M70326.	33	[*] M703B5.	34	[*] M70549.	38	[1] M70833.	58	[3] M7123K.	41
[*] M70327.	33	[*] M703B6.	34	[*] M7054A.	38	[1] M70834.	58	[3] M7123L.	41
[*] M70328.	33	[*] M703B7.	34	[*] M7054B.	38	[1] M70835.	58	[3] M7123M.	41
[*] M70329.	33	[*] M703B8.	34	[*] M7054C.	38	[*] M70911.	42	[3] M7123N.	41
[*] M70331.	34	[*] M703B9.	34	[*] M7054D.	38	[3] M71011.	58	[C] M7123O.	41
[*] M70332.	34	[*] M703D5.	33	[*] M7054E.	38	[*] M71012.	58	[3] M7123P.	41
[*] M70333.	34	[*] M703D6.	33	[*] M7054F.	38	[*] M71013.	58	[3] M7123Q.	41
[*] M70334.	34	[*] M703D7.	33	[*] M7054G.	38	[*] M71014.	58	[3] M7123R.	41
[*] M70335.	34	[*] M703D8.	33	[*] M7054H.	38	[*] M71015.	58	[C] M7123S.	41
[*] M70336.	34	[*] M703D9.	33	[1] M7054K.	38	[*] M71016.	58	[C] M7123T.	41
[*] M70337.	34	[*] M703DA.	33	[3] M70591.	38	[*] M71017.	58	[C] M7123U.	41
[*] M70338.	34	[*] M703DB.	33	[3] M70592.	38	[1] M71021.	58	[C] M7123V.	41
[*] M70339.	34	[*] M70431.	35	[3] M70593.	38	[*] M71022.	58	[C] M7123Z.	41
[*] M70341.	34	[*] M70432.	35	[*] M70594.	38	[*] M71023.	58	[*] M72031.	58
[*] M70342.	34	[*] M70433.	35	[*] M70595.	38	[*] M71024.	58	[*] M72032.	58

Code	Page	Code	Page	Code	Page	Code	Page	Code	Page
[*] M72034.	58	[C] M73327.	37	[*] M8404B.	50	[*] P10152.	96	[1] P13461.	99
[*] M72036.	58	[C] M733270010000	37	[*] M8404B0000A00	50	[*] P10152.	102	[1] P13463.	99
[3] M72051.	58	[C] M7332700G0000	37	[*] M8404C.	50	[*] P10153.	96	[1] P13471.	99
[1] M72052.	58	[C] M73328.	37	[*] M8404C0000A00	50	[*] P10153.	102	[1] P13473.	99
[*] M72053.	58	[C] M733280010000	37	[*] M8404D.	50	[*] P10154.	96	[1] P13491.	99
[*] M72112.	58	[C] M7332800G0000	37	[*] M8404D0000A00	50	[*] P10154.	102	[1] P13493.	99
[*] M72113.	58	[*] M73602.	30	[*] M8404E.	50	[*] P10155.	96	[*] P14035.	98
[*] M72114.	58	[*] M73602.	37	[*] M8404E0000A00	50	[*] P10155.	102	[*] P14211.	98
[*] M72131.	58	[*] M80132.	114	[*] M84053.	50	[*] P10156.	96	[*] P14212.	98
[*] M72132.	58	[*] M801320010000	114	[*] M840530000A00	50	[*] P10156.	102	[*] P14214.	98
[*] M72134.	58	[C] M81011.	52	[*] M84055.	50	[*] P10157.	96	[*] P16011.	98
[*] M72136.	58	[C] M81012.	52	[*] M840550000A00	50	[*] P10157.	102	[*] P16012.	98
[*] M72151.	58	[C] M81013.	52	[*] M8405B.	50	[*] P10158.	96	[*] P16013.	98
[*] M72152.	58	[C] M81014.	52	[*] M8405B0000A00	50	[*] P10158.	102	[*] P16014.	98
[*] M72153.	58	[C] M81015.	52	[*] M8405C.	50	[*] P10159.	96	[*] P16015.	98
[3] M72311.	42	[*] M810B1.	50	[*] M8405C0000A00	50	[*] P10159.	102	[*] P16021.	98
[3] M72321.	42	[*] M810B2.	50	[*] M8405D.	50	[*] P10160.	96	[*] P16022.	98
[3] M72322.	42	[*] M810B3.	50	[*] M8405D0000A00	50	[*] P10160.	102	[*] P16023.	98
[3] M72331.	42	[*] M810B4.	50	[*] M8405E.	50	[*] P10181.	96	[*] P16024.	98
[3] M72332.	42	[*] M810B5.	50	[*] M8405E0000A00	50	[*] P10181.	102	[*] P16025.	98
[3] M72341.	42	[*] M810C1.	50	[C] M84101.	52	[*] P10182.	96	[*] P16111.	99
[3] M72342.	42	[*] M810C2.	50	[*] M85050.	51	[*] P10182.	102	[*] P16121.	99
[3] M72352.	42	[*] M810C3.	50	[*] M85060.	51	[C] P11121.	97	[*] P16131.	99
[3] M72381.	42	[*] M810C4.	50	[*] M85070.	51	[C] P11121.	102	[*] P17221.	99
[3] M72382.	42	[*] M810C5.	50	[1] M86010.	51	[C] P11131.	97	[*] P17222.	99
[*] M73112.	30	[*] M810D1.	50	[1] M86013.	51	[C] P11131.	102	[*] P17231.	99
[*] M73112.	37	[*] M810D2.	50	[1] M86014.	51	[C] P11141.	97	[*] P17232.	99
[*] M73112.	91	[*] M810D3.	50	[1] M86015.	51	[C] P11141.	102	[*] P19921.	96
[*] M73113.	30	[*] M810D4.	50	[*] M86016.	51	[C] P11151.	97	[*] P19921.	102
[*] M73113.	37	[*] M810D5.	50	[*] M86017.	51	[C] P11151.	102	[*] P20210.	104
[*] M73113.	91	[*] M81611.	51	[*] M86018.	51	[*] P11731.	99	[*] P20211.	104
[*] M73114.	30	[*] M81612.	51	[*] M86019.	51	[*] P11751.	99	[*] P20213.	104
[*] M73114.	37	[*] M81613.	51	[*] M8601A.	51	[*] P11752.	99	[*] P20214.	104
[*] M73114.	91	[*] M81631.	51	[1] M8601B.	51	[*] P11753.	99	[*] P20215.	104
[*] M73115.	30	[*] M81632.	51	[2] M86020.	51	[*] P11755.	99	[*] P20216.	104
[*] M73115.	37	[*] M81633.	51	[2] M86030.	51	[*] P11756.	99	[*] P20217.	104
[*] M73115.	91	[*] M81641.	51	[*] M89909.	52	[*] P11757.	99	[*] P20218.	104
[*] M73116.	30	[*] M81642.	51	[*] M8990C.	52	[*] P11758.	99	[*] P20219.	104
[*] M73116.	37	[*] M81643.	51	[*] M8990D.	52	[*] P11941.	97	[*] P20221.	104
[*] M73116.	91	[*] M818110041500	25	[*] M8990E.	52	[*] P11944.	97	[*] P20223.	104
[*] M73117.	30	[*] M8181100418BA	25	[*] M8990F.	52	[*] P11951.	99	[*] P20224.	104
[*] M73117.	37	[*] M818120041500	25	[*] M89931.	51	[*] P11A61.	97	[*] P20225.	104
[*] M73117.	91	[*] M8181200418BY	25	[*] M90211.	31	[*] P12204.	97	[*] P20226.	104
[*] M73118.	30	[*] M81911.	50	[*] M90211.	48	[*] P12214.	97	[*] P20227.	104
[*] M73118.	37	[*] M81912.	50	[*] M90211.	93	[*] P12231.	97	[*] P20228.	104
[*] M73118.	91	[*] M81931.	50	[*] M90231.	31	[*]	97	[*] P20229.	104
[*] M73121.	30	[*] M81932.	50	[*] M90231.	48	P122320040000		[1] P20D60.	106
[*] M73121.	37	[*] M81941.	50	[*] M90231.	93	[*] P12711.	98	[1] P20D61.	106
[*] M73121.	91	[*] M81942.	50	[C] M90241.	31	[*] P12712.	98	[1] P20D62.	106
[*] M73122.	30	[*] M82502.	52	[C] M90241.	48	[*] P12A32.	97	[1] P20D63.	106
[*] M73122.	37	[*] M84011.	51	[C] M90241.	93	[1] P13231.	99	[1] P20D70.	106
[*] M73122.	91	[*] M84012.	51	[*] M90413.	48	[1] P13233.	99	[1] P20D71.	106
[*] M73123.	30	[*] M84014.	51	[1] M91111.	31	[1] P13251.	99	[1] P20D72.	106
[*] M73123.	37	[*] M84015.	51	[1] M91111.	48	[1] P13253.	99	[1] P20D73.	106
[*] M73123.	91	[*] M84016.	51	[1] M91111.	93	[1] P13261.	99	[1] P20E64.	106
[C] M73323.	37	[*] M84017.	51	[1] M91301.	31	[1] P13263.	99	[1] P20E74.	106
[C] M733230010000	37	[*] M84023.	50	[1] M91301.	48	[1] P13271.	99	[1] P21810.	107
[C] M7332300G0000	37	[*] M840230000A00	50	[1] M91301.	93	[1] P13273.	99	[1] P21811.	107
[C] M73325.	37	[*] M84033.	50	[*] P10131.	96	[1] P13291.	99	[1] P21812.	107
[C] M733250010000	37	[*] M840330000A00	50	[*] P10131.	102	[1] P13293.	99	[1] P21813.	107
[C] M7332500G0000	37	[*] M84043.	50	[*] P10132.	96	[1] P13431.	99	[1] P21814.	107
[C] M73326.	37	[*] M840430000A00	50	[*] P10132.	102	[1] P13433.	99	[1] P21815.	107
[C] M733260010000	37	[*] M84045.	50	[*] P10151.	96	[1] P13451.	99	[1] P21816.	107
[C] M7332600G0000	37	[*] M840450000A00	50	[*] P10151.	102	[1] P13453.	99	[1] P21817.	107

Code	Page	Code	Page	Code	Page	Code	Page	Code	Page
[4] P50352.	112	[C] P721150017000	126	[*] Q26112.	26	[3] Q309650100000	86	[1] QB880	83
[4] P50353.	112	[*] P72117.	126	[*] Q26112.	92	[3] Q309660100000	39	[1] QB8D0	83
[4] P50354.	112	[C] P721170017000	126	[*] Q301T1.	39	[3] Q309660100000	86	[1] QB8E0	83
[4] P50355.	112	[*] P72120.	126	[*] Q301T1.	86	[3] Q309670100000	39	[1] QB8I0	84
[4] P50356.	112	[C]	126	[C] Q301T1010E000	39	[3] Q309670100000	86	[1] QBJ10	83
[4] P50357.	112	P721200017000		[C] Q301T1010E000	86	[3] Q309710100000	39	[1] QBJ20	83
[4] P50361.	112	[*] P72125.	126	[*] Q301T2.	39	[3] Q309710100000	86	[1] QBJ60	83
[4] P50362.	112	[C] P721250017000	126	[*] Q301T2.	86	[3] Q309720100000	39	[1] QBJ70	83
[4] P50363.	112	[*] P72130.	126	[C] Q301T2010E000	39	[3] Q309720100000	86	[1] QBK10	83
[4] P50364.	112	[C] P721300017000	126	[C] Q301T2010E000	86	[3] Q309730100000	39	[1] QBK20	83
[4] P50365.	112	[*] P72135.	126	[*] Q301T3.	39	[3] Q309730100000	86	[1] QBK50	83
[4] P50366.	112	[C] P721350017000	126	[*] Q301T3.	86	[3] Q309740100000	86	[1] QBK60	83
[C] P6012300A0000	113	[*] P72140.	126	[C] Q301T3010E000	39	[3] Q309810100000	39	[1] QBL10	83
[C] P6021100A0000	113	[C] P721400017000	126	[C] Q301T3010E000	86	[3] Q309810100000	86	[1] QBL20	83
[C] P6021200A0000	113	[*] P72145.	126	[*] Q301T4.	39	[3] Q309820100000	39	[1] QBL50	83
[C] P6021300A0000	113	[C] P721450017000	126	[*] Q301T4.	86	[3] Q309820100000	86	[1] QBL60	83
[C] P6031200A0000	113	[*] P72150.	126	[C] Q301T4010E000	39	[3] Q309830100000	39	[1] QBM00M20	83
[C] P6052100A0000	113	[C]	126	[C] Q301T4010E000	86	[3] Q309830100000	86	[1] QBM00M21	83
[C] P6052200A0000	113	P721500017000		[*] Q30213EN000000	30	[3] Q309840100000	39	[1] QBM00M23	83
[C] P6062200A0000	113	[*] P72155.	126	[*] Q30213EN000000	47	[3] Q309840100000	86	[1] QBM03	83
[C] P6071100A0000	113	[C]	126	[*] Q30213EN000000	85	[3] Q309850100000	39	[1] QBM07	83
[C] P6071400A0000	113	P721550017000		[*] Q30213EN000000	92	[3] Q309850100000	86	[1] QBM20M20	83
[C] P69901.	113	[C] P72210.	126	[*] Q30213IB000000	30	[3] Q309860100000	39	[1] QBM20M21	83
[C] P69902.	113	[C] P72212.	126	[*] Q30213IB000000	47	[3] Q309860100000	86	[1] QBM20M23	83
[C] P69903.	113	[C] P72215.	126	[*] Q30213IB000000	85	[3] Q309870100000	39	[1] QBM83	83
[C] P6990A.	113	[C] P72217.	126	[*] Q30213IB000000	92	[3] Q309870100000	86	[1] QBM85	83
[4] P70210.	127	[C] P72220.	126	[*] Q30230.	30	[3] Q309A10100000	39	[1] QBM87	83
[4] P70215.	127	[C] P72225.	126	[*] Q30230.	47	[3] Q309A10100000	86	[1] QBN00	83
[4] P70220.	127	[C] P72230.	126	[*] Q30230.	85	[3] Q309A20100000	39	[1] QBN0B	83
[4] P70225.	127	[C] P72235.	126	[*] Q30230.	92	[3] Q309A20100000	86	[1] QBN0J	83
[4] P70230.	127	[C] P72240.	126	[*] Q30301.	85	[3] Q309A30100000	39	[1] QBN10	83
[4] P70235.	127	[C] P72245.	126	[*] Q30302.	85	[3] Q309A30100000	86	[1] QBN1B	83
[4] P70240.	127	[C] P72250.	126	[*] Q30423.	85	[3] Q309A40100000	86	[1] QBN1J	83
[4] P70245.	127	[C] P72255.	126	[C] Q30501.	84	[3] Q309A60100000	86	[1] QBN2B	83
[4] P70250.	127	[C] P72330.	126	[3] Q309010100000	39	[C] Q31100.	84	[1] QBN2J	83
[4] P70255.	127	P723300017000		[3] Q309010100000	86	[C] Q31400.	85	[1] QBN30	83
[2] P70301.	145	[C] P72335.	126	[3] Q309020100000	39	[C] Q39970.	85	[1] QBN3B	83
[2] P70302.	145	[C] P72340.	126	[3] Q309020100000	86	[1] Q46210.	84	[1] QBN3J	83
[2] P70303.	145	[C] P72345.	126	[3] Q309030100000	39	[1] Q46211.	84	[1] QBN40	83
[2] P70304.	145	[C] P72350.	126	[3] Q309030100000	86	[1] Q46220.	84	[C] QM4000.	90
[2] P70305.	145	[C]	126	[3] Q309040100000	39	[1] Q46221.	84	[C] QM4001.	90
[2] P70306.	145	P723500017000		[3] Q309040100000	86	[1] Q46230.	84	[C] QM4010.	90
[2] P70307.	145	[C]	126	[3] Q309050100000	39	[1] Q46231.	84	[C] QM4011.	84
[2] P70308.	145	P724200017000		[3] Q309050100000	86	[1] Q46240.	84	[C] QM4021.	90
[2] P70309.	145	[C] Q20112.	52	[3] Q309060100000	39	[1] Q46241.	84	[C] QM4022.	90
[2] P7030B.	145	[C] Q20122.	52	[3] Q309060100000	86	[1] Q46242.	84	[C] QM4023.	90
[2] P7030D.	145	[C] Q20132.	52	[3] Q309070100000	39	[1] Q46250.	84	[C] QM4024.	90
[2] P7030E.	145	[*] Q20901.	29	[3] Q309070100000	86	[1] Q46251.	84	[C] QM4025.	90
[2] P7030G.	145	[*] Q20902.	29	[3] Q309110100000	39	[C] Q47001.	90	[C] QM4026.	90
[C] P7030J.	145	[*] Q20903.	29	[3] Q309110100000	86	[C] Q47009.	90	[C] QP102	84
[C] P7030K.	145	[*] Q20911.	29	[3] Q309120100000	39	[1] Q4994E.	30	[C] QP302	84
[C] P7030M.	145	[*] Q20912.	29	[3] Q309120100000	86	[1] Q4994E.	47	[*] R10851.	119
[C] P71021.	126	[*] Q20913.	29	[3] Q309130100000	39	[1] Q4994E.	85	[*] R10853.	119
[C] P71022.	126	[*] Q20921.	29	[3] Q309130100000	86	[1] Q4994E.	92	[*] R10862.	119
[C] P71023.	126	[*] Q20931.	29	[3] Q309140100000	86	[1] QB3C0	84	[*] R10864.	119
[C]	126	[*] Q20932.	29	[3] Q309140100000	39	[1] QB3C3	84	[*] R10871.	118
P710230017000		[*] Q20933.	29	[3] Q309160100000	86	[1] QB4B0	83	[*] R108710020000	118
[C] P71024.	126	[*] Q21112.	91	[3] Q309160100000	39	[1] QB4C0	83	[*] R108710040000	118
[C] P710240017000	126	[*] Q21114.	91	[3] Q30920100000	86	[1] QB4H0	83	[*] R10872.	118
[C] P71025.	126	[*] Q22312.	91	[3] Q30920100000	39	[1] QB4I0	83	[*] R108720020000	118
[*] P72110.	126	[*] Q22314.	91	[3] Q309630100000	39	[1] QB4N0	84	[*] R108720040000	118
[*] P72112.	126	[*] Q23100.	91	[3] Q309640100000	86	[C] QB4P0	84	[*] R11211.	118
[C] P721130017000	126	[C] Q23400.	91	[3] Q309640100000	39	[C] QB4P1	84	[*] R13810.	118
[*] P72115.	126	[*] Q23422.	91	[3] Q309650100000	86	[C] QB4P1	84	[*] R13820.	118
		[*] Q23424.	91	[3] Q309650100000	39	[1] QB870	83		

Code	Page	Code	Page	Code	Page	Code	Page	Code	Page
[*] R13821.	118	[C] R2035G.	128	[*] R2325J.	124	[1] R2371C.	129	[C] R2422H.	127
[*] R13822.	118	[C] R2035H.	128	[*] R2325K.	124	[1] R2371D.	129	[C] R2422J.	127
[*] R13823.	118	[C] R2035J.	128	[*] R2325L.	124	[1] R2371E.	129	[C] R2422K.	127
[*] R13851.	118	[C] R2035K.	128	[*] R2325Q.	124	[1] R2371F.	129	[C] R2425A.	127
[*] R13862.	118	[C] R2035L.	128	[*] R2325R.	124	[1] R2371G.	129	[C] R2425D.	127
[*] R13864.	118	[1] R205C4.	120	[C] R2326C.	124	[1] R2371H.	129	[C] R2425F.	127
[*] R13951.	119	[1] R205C8.	120	[C] R2326E.	124	[1] R23948.	129	[C] R2425G.	127
[*] R13953.	119	[1] R205CM.	120	[C] R2326F.	124	[1] R2394A.	129	[C] R2425H.	127
[*] R13962.	119	[1] R205CN.	120	[C] R2326G.	124	[1] R2394C.	129	[C] R2425J.	127
[*] R13964.	119	[1] R2137A.	123	[C] R2326H.	124	[*] R2394D.	129	[C] R2425K.	127
[*] R20114.	128	[1] R2137P.	123	[C] R2326J.	124	[1] R2394E.	129	[C] R2425L.	127
[*] R20116.	128	[1] R2137T.	123	[C] R2326K.	124	[*] R2394F.	129	[C] R2425P.	127
[*] R20118.	128	[1] R2138D.	123	[C] R2326L.	124	[*] R2394G.	129	[C] R2425R.	127
[*] R2011A.	128	[1] R2138G.	123	[C] R2326M.	124	[*] R2394H.	129	[2] R2473G.	128
[*] R2011C.	128	[1] R2139D.	123	[1] R2327C.	124	[*] R2394J.	129	[2] R2473H.	128
[*] R2011D.	128	[1] R2139H.	123	[1] R2327F.	124	[*] R2394K.	129	[2] R2473J.	128
[*] R2011E.	128	[1] R2139R.	123	[1] R2327H.	124	[*] R2394L.	129	[2] R2473K.	128
[*] R20134.	128	[1] R213A8.	123	[1] R2327J.	124	[*] R2394M.	129	[2] R2473L.	128
[*] R20138.	128	[1] R213AE.	123	[1] R2327K.	124	[1] R23958.	129	[2] R2473M.	128
[*] R2013A.	128	[2] R21574.	130	[1] R2327L.	124	[1] R2395A.	129	[2] R2473N.	128
[*] R2013C.	128	[2] R21575.	130	[1] R2327M.	124	[1] R2395C.	129	[C] R277AC.	124
[*] R2013D.	128	[2] R21578.	130	[2] R23288.	124	[1] R2395D.	129	[C] R277AE.	124
[*] R2013E.	128	[2] R21579.	130	[2] R2328A.	124	[1] R2395E.	129	[C] R277AF.	124
[*] R2013F.	128	[2] R2157A.	130	[2] R2328C.	124	[1] R2395F.	129	[C] R277AG.	124
[*] R2013G.	128	[C] R22574.	130	[2] R2328D.	124	[1] R2395G.	129	[C] R277AH.	124
[*] R20144.	128	[C] R22575.	130	[2] R2328E.	124	[1] R2395H.	129	[C] R277AJ.	124
[*] R20148.	128	[C] R22578.	130	[2] R2328F.	124	[1] R2395J.	129	[C] R277AK.	124
[*] R2014A.	128	[C] R22579.	130	[2] R2328G.	124	[1] R2395K.	129	[C] R277AL.	124
[*] R2014C.	128	[C] R2257A.	130	[2] R2328H.	124	[1] R2395L.	129	[C] R281A1.	123
[*] R2014D.	128	[C] R2257C.	130	[2] R2328J.	124	[1] R2395P.	129	[C] R281A3.	123
[*] R2014E.	128	[C] R2257D.	130	[2] R23298.	124	[1] R2395Q.	129	[C] R281A4.	123
[*] R2014F.	128	[C] R2257E.	130	[2] R2329A.	124	[1] R2412A.	125	[C] R281A5.	123
[*] R2014G.	128	[C] R2257F.	130	[2] R2329C.	124	[1] R2412D.	125	[C] R281A6.	123
[*] R2014J.	128	[C] R2257G.	130	[2] R2329D.	124	[1] R2412E.	125	[C] R281A8.	123
[1] R2015A.	128	[*] R2321C.	124	[*] R2329E.	124	[1] R2412G.	125	[C] R281A9.	123
[1] R20158.	128	[2] R2321D.	124	[2] R2329F.	124	[1] R2412H.	125	[C] R281AD.	123
[1] R2015A.	128	[*] R2321E.	124	[*] R2329G.	124	[1] R2412J.	125	[*] R29911.	120
[1] R2015C.	128	[*] R2321F.	124	[*] R2329H.	124	[1] R2412K.	125	[*] R29915.	120
[1] R2015D.	128	[2] R2321G.	124	[*] R2329J.	124	[1] R2412L.	125	[*] R29916.	120
[*] R2015E.	128	[2] R2321H.	124	[*] R2329K.	124	[1] R2415A.	125	[*] R29917.	120
[*] R2031C.	128	[*] R2321J.	124	[*] R2329L.	124	[1] R2415D.	125	[*] R29918.	120
[*] R2031D.	128	[*] R2321K.	124	[2] R2329P.	124	[1] R2415E.	125	[C] R2H511.	120
[*] R2031E.	128	[*] R2323E.	124	[*] R2329Q.	124	[1] R2415F.	125	[C] R2H516.	120
[*] R2031F.	128	[*] R2323F.	124	[3] R232BC.	124	[1] R2415G.	125	[C] R2H517.	120
[*] R2031G.	128	[*] R2323G.	124	[3] R232BE.	124	[1] R2415H.	125	[C] R2H518.	120
[*] R2031H.	128	[*] R2323H.	124	[3] R232BF.	124	[1] R2415J.	125	[C] R2H51B.	120
[*] R2033C.	128	[*] R2323J.	124	[3] R232BG.	124	[*] R2415K.	125	[C] R2H51D.	120
[*] R2033D.	128	[*] R2323K.	124	[3] R232BH.	124	[*] R2415L.	125	[C] R2H51E.	120
[*] R2033E.	128	[*] R2323L.	124	[3] R232BJ.	124	[*] R2415P.	125	[C] R2H541.	120
[*] R2033F.	128	[*] R2323Q.	124	[3] R232BK.	124	[*] R2415R.	125	[*] R2H542.	120
[*] R2033G.	128	[*] R2323R.	124	[3] R232BL.	124	[C] R241DA.	125	[C] R2H543.	120
[*] R2033H.	128	[*] R2324E.	124	[3] R232BQ.	124	[C] R241DD.	125	[C] R2H544.	120
[*] R2033J.	128	[*] R2324F.	124	[3] R232BR.	124	[C] R241DF.	125	[*] R2H546.	120
[*] R2033K.	128	[2] R2324G.	124	[1] R23618.	129	[C] R241DG.	125	[*] R2H547.	120
[*] R2034E.	128	[*] R2324H.	124	[1] R2361A.	129	[C] R241DH.	125	[*] R2H54B.	120
[*] R2034F.	128	[*] R2324J.	124	[1] R2361C.	129	[C] R241DI.	125	[*] R2H54D.	120
[*] R2034G.	128	[*] R2324K.	124	[1] R2361D.	129	[C] R241DK.	125	[*] R2H54E.	120
[*] R2034H.	128	[*] R2324L.	124	[1] R2361E.	129	[C] R241DL.	125	[C] R2H54G.	120
[*] R2034J.	128	[*] R2324Q.	124	[1] R2361F.	129	[C] R241DP.	125	[*] R2H54J.	120
[*] R2034K.	128	[*] R2324R.	124	[1] R2361G.	129	[C] R241DR.	125	[*] R2H54L.	120
[C] R2035C.	128	[2] R2325E.	124	[1] R2361H.	129	[C] R2422A.	127	[c] R2H54M.	120
[C] R2035D.	128	[*] R2325F.	124	[1] R2361J.	129	[C] R2422D.	127	[*] R2H54N.	120
[C] R2035E.	128	[2] R2325G.	124	[1] R23718.	129	[C] R2422E.	127	[C] R2H54R.	120
[C] R2035F.	128	[*] R2325H.	124	[1] R2371A.	129	[C] R2422G.	127	[*] R2H54S.	120

Code	Page	Code	Page	Code	Page	Code	Page	Code	Page
[*] R2H55D.	120	[C] R2H67C.	122	[2] R36L50.	134	[*] R3Z320.	123	[2] R54V35.	136
[*] R2H55E.	120	[C] R2H67D.	122	[2] R36L60.	134	[*] R3Z330.	123	[2] R54V40.	136
[*] R2H55H.	120	[C] R2H67E.	122	[2] R36L70.	134	[*] R3Z340.	123	[2] R54V45.	136
[*] R2H55L.	120	[C] R2H67I.	122	[2] R37L30.	134	[*] R3Z350.	123	[2] R54W50.	136
[*] R2H55N.	120	[C] R2H67J.	122	[2] R37L40.	134	[2] R46420.	139	[2] R54W55.	136
[C] R2H56B.	121	[C] R2H67K.	122	[*] R3L110.	134	[2] R46422.	139	[2] R54W60.	136
[C] R2H56D.	121	[C] R2H67L.	122	[*] R3L120.	134	[2] R46424.	139	[2] R54W65.	136
[C] R2H56E.	121	[C] R2H67N.	122	[*] R3L130.	134	[2] R46425.	139	[2] R5X350.	130
[C] R2H56J.	121	[C] R2H67P.	122	[*] R3L140.	134	[2] R46426.	139	[2] R5X350.	136
[C] R2H56L.	121	[C] R2H67R.	122	[*] R3L150.	134	[2] R46431.	139	[2] R5X370.	130
[C] R2H56N.	121	[C] R2H68A.	123	[*] R3L160.	134	[2] R46435.	139	[2] R5X370.	136
[C] R2H56R.	121	[C] R2H68B.	123	[1] R3L170.	134	[2] R46437.	139	[2] R5X380.	130
[C] R2H578.	121	[C] R2H68E.	123	[1] R3L180.	134	[2] R46438.	139	[2] R5X380.	136
[C] R2H579.	121	[C] R2H68I.	123	[*] R3L210.	134	[2] R46442.	139	[2] R5X390.	130
[*] R2H57B.	121	[C] R2H68J.	123	[*] R3L220.	134	[2] R46444.	139	[2] R5X390.	136
[*] R2H57D.	121	[C] R2H68K.	123	[1] R3L230.	134	[2] R46450.	139	[2] R5X3A0.	130
[*] R2H57E.	121	[C] R2H68L.	123	[*] R3L240.	134	[2] R46455.	139	[2] R5X3A0.	136
[*] R2H57J.	121	[C] R2H68N.	123	[1] R3L250.	134	[2] R46505.	139	[2] R5X3B0.	130
[*] R2H57L.	121	[C] R2H68P.	123	[1] R3L260.	134	[2] R46604.	139	[2] R5X3B0.	136
[*] R2H57N.	121	[C] R2H69B.	123	[*] R3L310.	134	[2] R46605.	139	[2] R5Y350.	130
[C] R2H57R.	121	[C] R2H69D.	123	[1] R3L320.	134	[2] R46606.	139	[2] R5Y350.	136
[C] R2H57S.	121	[C] R2H69E.	123	[*] R3L330.	134	[2] R46608.	139	[2] R5Y370.	130
[C] R2H598.	121	[C] R2H69J.	123	[1] R3L340.	134	[2] R46609.	139	[2] R5Y370.	136
[C] R2H59B.	121	[C] R2H69L.	123	[1] R3L350.	134	[C] R4A300.	138	[2] R5Y380.	130
[C] R2H59D.	121	[C] R2H69N.	123	[1] R3L410.	134	[C] R4A304.	138	[2] R5Y380.	136
[C] R2H59E.	121	[C] R2H69R.	123	[1] R3L420.	134	[C] R4A309.	138	[2] R5Y390.	130
[C] R2H59J.	121	[C] R2H69S.	123	[1] R3L430.	134	[C] R4A318.	138	[2] R5Y390.	136
[C] R2H59L.	121	[C] R2H762.	122	[1] R3L440.	134	[C] R4A321.	138	[2] R5Y3A0.	130
[C] R2H59N.	121	[C] R2H766.	122	[1] R3L450.	134	[C] R4A330.	138	[2] R5Y3A0.	136
[C] R2H59R.	121	[C] R2H767.	122	[*] R3Q631EN00000	134	[C] R4A336.	138	[2] R5Y3B0.	130
[C] R2H59S.	121	[C] R2H768.	122	[*] R3Q641EN00000	134	[C] R4E103.	135	[2] R5Y3B0.	136
[C] R2H622.	122	[C] R2H772.	122	[*] R3Q651EN00000	134	[C] R4E104.	135	[2] R64C25.	140
[C] R2H626.	122	[C] R2H776.	122	[*] R3Q671EN00000	134	[C] R4E105.	135	[2] R64C30.	140
[C] R2H627.	122	[C] R2H777.	122	[*] R3Q681EN00000	134	[C] R4E106.	135	[2] R64C35.	140
[C] R2H628.	122	[C] R2H778.	122	[*] R3Q691EN00000	134	[C] R4E108.	135	[2] R64C40.	140
[C] R2H62B.	122	[C] R2H782.	123	[*] R3Q6D1EN00000	134	[C] R4E113.	135	[2] R64C45.	140
[C] R2H62D.	122	[C] R2H786.	123	[*] R3Q6E1EN00000	134	[C] R4E114.	135	[2] R64E24.	140
[C] R2H62E.	122	[C] R2H787.	123	[*] R3Q6F1EN00000	134	[C] R4E115.	135	[2] R64E25.	140
[C] R2H641.	122	[C] R2H788.	123	[*] R3Q71EN00000	134	[C] R4E116.	135	[2] R64E28.	140
[C] R2H642.	122	[C] R2H792.	123	[1] R3Q771EN00000	134	[2] R54R64.	136	[2] R64E29.	140
[C] R2H643.	122	[C] R2H796.	123	[*] R3Q781EN00000	134	[2] R54R74.	136	[2] R64E30.	140
[C] R2H644.	122	[C] R2H798.	123	[1] R3Q7E1EN00000	134	[2] R54R81.	136	[2] R64E32.	140
[C] R2H646.	122	[C] R2H812.	120	[1] R3Q7F1EN00000	134	[2] R54R88.	136	[2] R64E34.	140
[C] R2H647.	122	[*] R2H848.	120	[*] R3Q7G1EN00000	134	[2] R54R92.	136	[2] R64J25.	140
[C] R2H648.	122	[*] R2H857.	120	[1] R3Q7H1EN00000	134	[2] R54R95.	136	[2] R64J30.	140
[C] R2H64B.	122	[C] R2H862.	121	[1] R3Q7J1EN00000	134	[2] R54S24.	136	[2] R64J35.	140
[C] R2H64D.	122	[C] R2H866.	121	[1] R3S141.	131	[2] R54S25.	136	[2] R64J40.	140
[C] R2H64E.	122	[C] R2H868.	121	[1] R3S151.	131	[2] R54S28.	136	[2] R64J45.	140
[C] R2H64J.	122	[C] R2H872.	121	[1] R3S161.	131	[2] R54S29.	136	[2] R64K36.	140
[C] R2H64L.	122	[C] R2H873.	121	[1] R3S181.	131	[2] R54S30.	136	[2] R64K38.	140
[C] R2H64N.	122	[C] R2H875.	121	[1] R3S421.	131	[2] R54S32.	136	[2] R64K40.	140
[C] R2H64R.	122	[*] R2H876.	121	[1] R3S431.	131	[2] R54S34.	136	[2] R64K42.	140
[C] R2H64S.	122	[C] R2H877.	121	[1] R3S441.	131	[2] R54T25.	136	[2] R64K44.	140
[C] R2H66B.	122	[C] R2H878.	121	[1] R3S451.	131	[2] R54T30.	136	[2] R64L50.	140
[C] R2H66D.	122	[C] R2H892.	121	[1] R3S461.	131	[2] R54T35.	136	[2] R64L55.	140
[C] R2H66E.	122	[C] R2H896.	121	[1] R3S481.	131	[2] R54T40.	136	[2] R64L60.	140
[C] R2H66J.	122	[1] R35L10.	134	[1] R3S491.	131	[2] R54T45.	136	[2] R64L65.	140
[C] R2H66L.	122	[1] R35L20.	134	[1] R3S4A1.	131	[2] R54U36.	136	[2] R64R64.	140
[C] R2H66N.	122	[1] R35L30.	134	[1] R3S4B1.	131	[2] R54U38.	136	[2] R64R74.	140
[C] R2H66R.	122	[1] R35L40.	134	[1] R3S4D1.	131	[2] R54U40.	136	[2] R64R81.	140
[C] R2H66S.	122	[2] R36L10.	134	[1] R3Z210.	123	[2] R54U42.	136	[2] R64R88.	140
[C] R2H678.	122	[2] R36L20.	134	[*] R3Z220.	123	[2] R54U44.	136	[2] R64R92.	140
[C] R2H67A.	122	[2] R36L30.	134	[*] R3Z230.	123	[2] R54V25.	136	[2] R64R95.	140
[C] R2H67B.	122	[2] R36L40.	134	[*] R3Z310.	123	[2] R54V30.	136	[4] R73105.	146

Code	Page	Code	Page	Code	Page	Code	Page	Code	Page
[4] R73106.	146	[4] R7K106.	146	[C] R8C4000009530	149	[C] R8L6000011000	150	[3] V41231.	158
[4] R73107.	146	[4] R7K107.	146	[C] R8C5000009530	149	[C] R8L7500011000	150	[3] V41232.	158
[4] R73108.	146	[4] R7K108.	146	[C] R8C6000009530	149	[C] V10610.	156	[3] V41233.	158
[4] R73109.	146	[C] R7LF75.	145	[C] R8C7500009530	149	[C] V10611.	156	[3] V41261.	158
[4] R73110.	146	[C] R7LF77.	145	[C] R8D0500012700	149	[C] V10612.	156	[3] V41262.	158
[4] R73111.	146	[C] R7LM73.	145	[C] R8D0750012700	149	[C] V10613.	156	[3] V41263.	158
[4] R73112.	146	[C] R7LM7B.	145	[C] R8D1000012700	149	[C] V10617.	156	[3] V41461.	158
[4] R73113.	146	[C] R7QF05.	145	[C] R8D1500012700	149	[C] V10620.	156	[3] V41462.	158
[4] R73114.	146	[C] R7QF07.	145	[C] R8D1670012700	149	[C] V10621.	156	[3] V41463.	158
[4] R73115.	146	[C] R7QM03.	145	[C] R8D2000012700	149	[C] V10622.	156	[*] V42002.	158
[4] R73116.	146	[C] R7QM0B.	145	[C] R8D2500012700	149	[C] V10623.	156	[*] V42003.	158
[4] R73117.	146	[4] R7S002.	146	[C] R8D3000012700	149	[C] V10625.	156	[*] V42004.	158
[4] R73118.	146	[4] R7S004.	146	[C] R8D3330012700	149	[C] V10626.	156	[*] V42005.	158
[4] R73119.	146	[4] R7S006.	146	[C] R8D4000012700	149	[C] V10627.	156	[*] V42006.	158
[4] R73120.	146	[4] R7S008.	146	[C] R8D5000012700	149	[8] V17010.	156	[*] V42008.	158
[4] R73121.	146	[4] R7S00A.	146	[C] R8D6000012700	149	[8] V17015.	156	[*] V42009.	158
[4] R73122.	146	[2] R80628.	151	[C] R8D7500012700	149	[8] V17020.	156		
[4] R732050070000	146	[2] R80637.	151	[C] R8E0500019050	150	[8] V17030.	156		
[4] R732070070000	146	[*] R80664.	151	[C] R8E0750019050	150	[8] V17110.	156		
[4] R732080070000	146	[2] R80672.	151	[C] R8E1000019050	150	[8] V17115.	156		
[4] R732090070000	146	[2] R80691.	151	[C] R8E1500019050	150	[8] V17120.	156		
[4] R732100070000	146	[2] R80739.	151	[C] R8E1670019050	150	[8] V17130.	156		
[4] R732110070000	146	[2] R80748.	151	[C] R8E2000019050	150	[8] V17131.	156		
[4] R732120070000	146	[2] R80757.	151	[C] R8E2500019050	150	[3] V23015.	157		
[4] R732130070000	146	[2] R80774.	151	[C] R8E3000019050	150	[3] V23025.	157		
[4] R732140070000	146	[2] R807A2.	151	[C] R8E3330019050	150	[3] V23032.	157		
[4] R732150070000	146	[2] R807B1.	151	[C] R8E4000019050	150	[3] V23035.	157		
[4] R732160070000	146	[*] R80921.	151	[C] R8E5000019050	150	[3] V23045.	157		
[4] R732170070000	146	[*]		[C] R8E6000019050	150	[3] V23050.	157		
[4] R732180070000	146	R809210010000	151	[C] R8E7500019050	150	[3] V23115.	157		
[4] R732190070000	146	[C] R8A0500003810	149	[C] R8K0500003300	150	[3] V23116.	157		
[4] R732200070000	146	[C] R8A0750003810	149	[C] R8K0500006600	150	[3] V23121.	157		
[4] R732210070000	146	[C] R8A1000003810	149	[C] R8K0750003300	150	[3] V23125.	157		
[4] R732220070000	146	[C] R8A1500003810	149	[C] R8K0750006600	150	[3] V23126.	157		
[*] R78101.	147	[C] R8A1670003810	149	[C] R8K1000003300	150	[3] V23215.	157		
[C] R78121.	147	[C] R8A2000003810	149	[C] R8K1000066000	150	[3] V23315.	157		
[C] R78122.	147	[C] R8A2500003810	149	[C] R8K1500003300	150	[3] V23325.	157		
[C] R78123.	147	[C] R8A3000003810	149	[C] R8K1500066000	150	[3] V23500.	157		
[C] R78124.	147	[C] R8A3330003810	149	[C] R8K2000003300	150	[3] V23530.	157		
[C] R78125.	147	[C] R8A4000003810	149	[C] R8K2000066000	150	[3] V25000.	157		
[C] R78126.	147	[C] R8A5000003810	149	[C] R8K2500003300	150	[3] V25010.	157		
[C] R78127.	147	[C] R8A6000003810	149	[C] R8K2500066000	150	[3] V25011.	157		
[C] R78128.	147	[C] R8B0500006350	149	[C] R8K3000003300	150	[3] V25012.	157		
[4] R78131.	147	[C] R8B0750006350	149	[C] R8K3000066000	150	[3] V25013.	157		
[4] R78132.	147	[C] R8B1000006350	149	[C] R8K3330003300	150	[3] V25014.	157		
[4] R78133.	147	[C] R8B1500006350	149	[C] R8K3330066000	150	[3] V25020.	157		
[4] R78134.	147	[C] R8B1670006350	149	[C] R8K4000003300	150	[3] V25030.	157		
[4] R78135.	147	[C] R8B2000006350	149	[C] R8K4000066000	150	[3] V25031.	157		
[4] R78136.	147	[C] R8B2500006350	149	[C] R8K5000003300	150	[3] V25032.	157		
[4] R78137.	147	[C] R8B3000006350	149	[C] R8K5000066000	150	[3] V25033.	157		
[4] R78138.	147	[C] R8B3330006350	149	[C] R8K6000003300	150	[3] V25034.	157		
[C] R7C101.	147	[C] R8B4000006350	149	[C] R8K6000066000	150	[3] V26030.	157		
[C] R7C103.	147	[C] R8B5000006350	149	[C] R8K7500003300	150	[3] V26040.	157		
[C] R7C105.	147	[C] R8B6000006350	149	[C] R8K7500066000	150	[3] V26041.	157		
[C] R7C107.	147	[C] R8B7500006350	149	[C] R8L0500011000	150	[3] V26050.	157		
[C] R7C108.	147	[C] R8C0500009530	149	[C] R8L0750011000	150	[3] V30012.	158		
[C] R7C109.	147	[C] R8C0750009530	149	[C] R8L1000011000	150	[*] V40125.	158		
[C] R7C112.	147	[C] R8C1000009530	149	[C] R8L1500011000	150	[*] V40126.	158		
[C] R7C113.	147	[C] R8C1500009530	149	[C] R8L2000011000	150	[3] V40310.	158		
[C] R7C115.	147	[C] R8C1670009530	149	[C] R8L2500011000	150	[3] V40311.	158		
[C] R7C117.	147	[C] R8C2000009530	149	[C] R8L3000011000	150	[3] V40312.	158		
[C] R7C118.	147	[C] R8C2500009530	149	[C] R8L3330011000	150	[3] V40321.	158		
[4] R7K104.	146	[C] R8C3000009530	149	[C] R8L4000011000	150	[3] V40322.	158		
[4] R7K105.	146	[C] R8C3330009530	149	[C] R8L5000011000	150	[3] V40323.	158		

DELIVERY TIME

- [*] Immediate delivery
- [1/2] Delivery within 2-3 working days
- [1] Delivery in 1 week – 5 working days
- [2] Delivery in 2 weeks – 10 working days
- [c] Consult delivery time

Delivery time are orientation (exworks) and are conditioned by the availability of material in the moment that the order is actually placed; delivery time is understood to be delivery in our warehouses, ready to be sent.

Once the order has been expedited, it can not be lengthened or modified. A new option will correspond to a new order with all of the pertinent requirements and conditions.

RETURNS

Any claim must be made within fifteen days from the reception of the merchandise; after this period no returns will be accepted.

The return must be made according to the terms duly laid out by CIRCUTOR out by CIRCUTOR, and in any case, merchandise that is accepted will be depreciated by a minimum of 15% of the net value billed.