

CVI3

CVI3 Vision

V 1.7.2.X

User manual



Model
CVI3 Vision

Part number
6159326910

TABLE OF CONTENTS

1 - SAFETY INSTRUCTIONS 6

1.1 - General instructions	6
1.2 - Personal safety.....	6
1.2.1 - Differential circuit breaker	6
1.2.2 - Power consumption.....	6
1.2.3 - Power supply.....	6
1.3 - Tool use hazards	6
1.4 - Tool care and service	6

2 - GETTING STARTED..... 7

2.1 - Front panel	7
2.2 - LEDs color code	7
2.3 - Bottom panel	7
2.4 - On receiving the controller	8
2.5 - Installation	8
2.6 - Changing the controller language	8

3 - CONTROLLER 9

3.1 - Using icons and keyboards	9
3.2 - Display.....	9
3.3 - Date & time.....	10
3.4 - Access manager.....	10
3.5 - Workgroup.....	11
3.5.1 - None (stand-alone)	11
3.5.2 - Primary controller	11
3.5.3 - Secondary controller	11
3.6 - Serial / USB.....	11
3.6.1 - Serial ports	11
3.6.2 - USB.....	12
3.7 - Networks	12
3.8 - Fieldbus.....	12
3.9 - Customized protocol.....	12
3.10 - CVINet.....	13
3.11 - Remote display.....	13
3.11.1 - PC/Windows	13
3.11.2 - Apple	14
3.11.3 - Android	14

4 - TIGHTENING UNIT..... 15

4.1 - General.....	15
4.1.1 - Add a name and a comment	15
4.1.2 - Running mode selection.....	15
4.1.3 - Pset selection source	15
4.1.4 - Options.....	15
4.2 - Run reverse parameters.....	16
4.3 - Options on «Reject report»	16
4.4 - Curves distribution.....	16
4.5 - Wireless battery tool management.....	17
4.6 - Wireless battery tool parameters.....	17
4.6.1 - Feature parameters.....	17
4.6.2 - Display parameters	18
4.6.3 - Network parameters.....	18

5 - TOOL 19

5.1 - Tool 1.....	19
5.2 - Tool 51.....	19

6 - PSET 20

6.1 - How to add a Pset.....	20
6.1.1 - Expert mode.....	20
6.1.2 - Simple mode	20
6.2 - General.....	21
6.2.1 - Remove fastener torque limit	21
6.2.2 - Pset start torque.....	21
6.2.3 - Overall angle mode	21
6.2.4 - Overall time mode	21
6.3 - General 2.....	22
6.3.1 - External stop abort Pset.....	22
6.3.2 - Thread direction	22
6.3.3 - Additional sensor.....	22
6.3.4 - Pset start/stop	23
6.3.5 - Torque transducer offset and span check...23	
6.3.6 - Reject on trigger lost	23
6.3.7 - Jog	23
6.3.8 - Rehit.....	23

6.3.9 - Socket release	23
6.3.10 - Ergostop.....	24
6.4 - Curves	24
6.5 - Pset coefficients	25
6.6 - How to copy / paste / delete a Pset.....	25
7 - STEP	25
7.1 - How to add/organize the steps.....	25
7.2 - General.....	26
7.3 - Tightening.....	27
7.3.1 - Torque control	27
7.3.2 - Angle control	28
7.3.3 - Torque OR angle control	28
7.3.4 - Torque AND angle control	29
7.3.5 - Yield point control.....	29
7.3.6 - Seating detection	29
7.4 - Monitoring & options.....	30
7.4.1 - Current monitoring	30
7.4.2 - Time monitoring.....	30
7.5 - Step options	30
7.5.1 - Angle reset.....	30
7.5.2 - Torque reset	30
7.5.3 - Offset reset.....	30
7.5.4 - Latch threshold.....	31
7.6 - Motor control	31
7.6.1 - 2 speed	31
7.6.2 - 3 speed - ergospeed	31
7.7 - External stop	31
7.8 - Result on external stop.....	31
7.9 - Loosening.....	32
7.9.1 - Torque control and angle monitoring.....	32
7.9.2 - Angle control and torque monitoring	32
7.9.3 - Motor control - loosening.....	33
7.10 - Prevailing.....	33
7.10.1 - Forward prevailing.....	33
7.10.2 - Motor control - forward prevailing.....	33
7.10.3 - Prevailing parameters	34
7.11 - Synchro step.....	35

8 - ASSEMBLY PROCESS 35

8.1 - How to create an Assembly Process.....	35
8.2 - How to view the list of Assembly Processes ...	36

9 - MONITORING 37

9.1 - Main screen.....	37
9.2 - Display change/Tool selection	37
9.3 - Report OK	37
9.4 - Report NOK.....	38
9.5 - Monitoring view menu	38
9.5.1 - Ellipse view (in Assembly Process running mode only).....	38
9.5.2 - Simple view	39
9.5.3 - Simple view - prevailing step.....	39
9.5.4 - Detailed view.....	39
9.5.5 - Curve view	40
9.6 - «All tools» display.....	40
9.6.1 - Twin.....	40
9.6.2 - Multi.....	40
9.6.3 - Workgroup.....	41
9.7 - Additional transducer.....	41
9.7.1 - Consistency mode.....	41
9.7.2 - Redundancy mode	41
9.8 - User information	42

10 - RESULTS 43

10.1 - Main screen description	43
10.2 - Detailed view	43
10.3 - Filter	44
10.4 - Curve.....	44

11 - MAINTENANCE	45	14 - APPENDIX - FIELDBUS.....	69
11.1 - Controller	45	14.1 - Data mapping types and variables.....	69
11.1.1 - USB key - Firmware upgrade	45	14.2 - Modules detailed description.....	76
11.1.2 - USB key - Save	45		
11.1.3 - USB key - Advanced diagnostic	45	15 - APPENDIX - CONNECTIONS	81
11.1.4 - CVILOGIX	46	15.1 - Tool connector.....	81
11.1.5 - Physical I/O configuration.....	46	15.2 - CVI II adaptor	81
11.1.6 - Event I/O programming	47	15.3 - RS232 - SubD 9pt.....	82
11.1.7 - Ping	47	15.4 - Digital inputs (0 – 24V).....	82
11.1.8 - Memory	48	15.5 - Digital outputs (0 – 24V).....	82
11.1.9 - Calibration of the controller screen.....	48	15.6 - Tightening flow chart and timing chart.....	83
11.2 - Tool.....	49	15.7 - Synchronizing single-channel controllers.....	85
11.2.1 - Tool identification / characteristics.....	49	15.8 - Synchronizing TWINCVI3 controllers	85
11.2.2 - Tool identification.....	49	15.9 - eBUS (for accessories)	86
11.2.3 - Tool characteristics (read-only)	49	15.10 - Workgroup.....	86
11.2.4 - Tool configuration (read-only).....	49		
11.2.5 - Tool monitoring.....	50	16 - APPENDIX - SPARE PARTS - CVI3	
11.2.6 - Transducer	50	VISION	87
11.2.7 - Temperature	50		
11.2.8 - Tool counters	50	17 - APPENDIX A - CONTROLLER POWER	
11.2.9 - Maintenance alarms	50	CONSUMPTION: CURRENT INLET .	88
11.3 - ePOD.....	51		
11.3.1 - Backup/Restore.....	51	18 - APPENDIX B - JVL6-32 RESIDUAL	
11.3.2 - Eject	51	CURRENT CIRCUIT BREAKER	89
11.3.3 - Repair.....	51		
11.3.4 - Erase results	51	19 - APPENDIX - ePOD.....	90
11.4 - User information	52		
11.5 - Hardware and firmware versions.....	52		
12 - APPENDIX - I/O AND EVENTS.....	54		
12.1 - Logical outputs	54		
12.2 - Logical inputs	59		
13 - APPENDIX - USER INFO CODES	63		

Original instructions.

© Copyright 2015, Desoutter HP2 7SJ UK

All rights reserved. Any unauthorized use or copying of the contents or part thereof is prohibited. This applies in particular to trademarks, model denominations, part numbers and drawings. Use only authorized parts. Any damage or malfunction caused by the use of unauthorised parts is not covered by Warranty or Product Liability.

1 - SAFETY INSTRUCTIONS

1.1 - General instructions



To reduce risk of injury, everyone using, installing, repairing, maintaining, changing accessories on, or working near this tool must read and understand the safety instructions before performing any such task.

Failure to follow all instructions listed below may result in electric shock, fire and / or serious personal injury.

- Refer to the following booklets:
 - General safety instructions, part no. 6159931790
 - Quick-start user manual, part no. 6159932290.



SAVE THESE INSTRUCTIONS CAREFULLY.

1.2 - Personal safety



WARNING: This power tool must be earthed.

If the power tool is not earthed, the system will disable the power stage and the tool will not start. The error message "Bad tool ground" will be displayed.

1.2.1 - Differential circuit breaker

The controller has a residual current circuit breaker with over-current protection fitted with a differential circuit-breaker for user protection. Any insulation defect in the cable or in the tool is detected by this device.

The circuit breaker protects from a leakage current exceeding 30 mA in 50 µs by automatic power cutoff. The device protects the operator from any electric shock and protects, the controller from the deterioration. To make sure that the detection of leakage current is functioning properly, the device must be tested monthly by pushing the yellow pushbutton.

It also has a fuse function. It protects the system from any short-circuit by automatic power cutoff.



- Refer to Appendix B - JVL6-32.

The circuit breaker must be switched on to restart the controller.

1.2.2 - Power consumption

The decision to install an external differential circuit-breaker depends on the type of internal electric network in the customer's plant.

This device detects any insulation defect between one of the phases of the network and the earth, immediately stops the tool by automatic power cutoff and protects the operator from any electric shock.

Should circuit-breakers be installed at line head, we recommend that you select equipment with the following specifications:

- Single-phased 240V 16A - curve D
- Single-phased 110V 32A - curve D.



- Refer to Appendix A: Controller Power consumption: Current inlet.

For information:

- standby consumption is 17 W.
- the max power available supplied via the 24Volt power supply (between pin 2 and 3 on I/O connector):
 - CVI3 Vision or CVI3 Function: 1 A (24V)
 - TWINCVI3: 2 A (24V).

1.2.3 - Power supply

- Only use the cord supplied with the controller to connect to the mains power supply.
- Do not modify the cord or use it for any other purpose.
- Only use genuine Desoutter replacement parts.
- Failure to follow these instructions may result in electric shock.

1.3 - Tool use hazards

The selection of the tool takes account of the operating conditions as stated by the user.

When selected, they must not exceed the operating limits as specified by the manufacturer.

Any excessive internal temperature of the tool electric motor is detected and stops the tool. The motor can start again only after the temperature has decreased.

Motor temperature limits are different for handheld tools and for fixed tools:

- 60°C for handheld tools.
- 100°C for fixed tools.

Although our cables are designed to work under drastic conditions, we recommend that you check the following points for a longer service life:

- Bending radius should not be lower than 10 times the cable diameter.
- Friction with the outer sheath should be restricted.
- Any direct pull on the cable should be avoided.

1.4 - Tool care and service

Only experienced and qualified personnel (authorized electricians) are entitled to open and have access to the inside of the controller.

- If in doubt, return the tool to a Desoutter-authorized service centre. Contact your Desoutter representative for support.
- Disconnect from power supply and wait 10 minutes before starting service operations.



Failure to wait 10 minutes may result in electric shock from not yet unloaded capacitors.



According to Directive 2012/19/CE concerning Waste Electrical and Electronic Equipment (WEEE), this product must be recycled.



- Contact your Desoutter representative or consult the website "www.desouttertools.com" to find out where you can recycle this product.

2 - GETTING STARTED

2.1 - Front panel

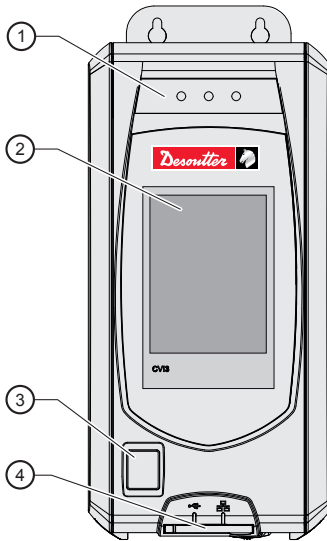

Legend

- 1 Report LEDs
- 2 Touchscreen color display
- 3 On / Off switch
- 4 Dedicated PC software port + USB port

2.2 - LEDs color code

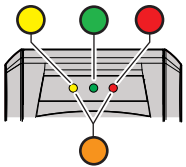

LED color	Designation	Action
Green	Accept report	-
Yellow	Incomplete rundown	Tighten again
Orange	Reject report	Loosen and tighten again
Red	Above High Angle	Remove and replace fastener.

2.3 - Bottom panel

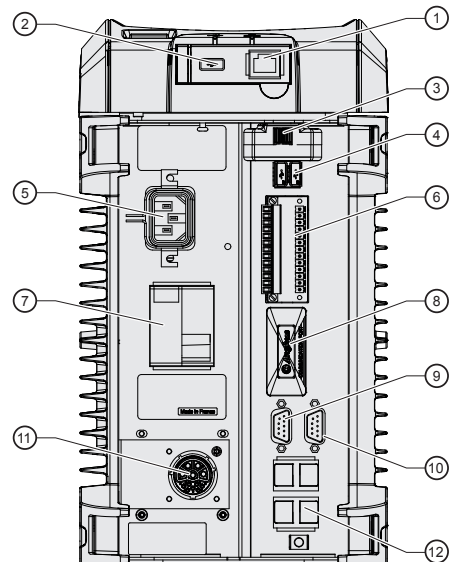

Legend

- 1 Ethernet port dedicated only to PC software
- 2 USB port for data transfer / firmware updating / access control management
- 3 ePOD port for controller backup, memory extension, customer features activation, workgroup configuration.
- 4 2 USB ports to connect barcode readers
- 5 Auto-sensing input voltage mains connector
- 6 2x8 I/O connector dedicated to customer use + 2 quick stops.
- 7 Ground Fault Interruptor: earth fault and overcurrent protection
- 8 Fieldbus port for plug & play Fieldbus modules
- 9 eBUS to daisy-chain up to 15 accessories (e.g. socket tray)
- 10 RS232 port (2 serial ports) to connect: Barcode reader / Delta measuring unit
- 11 8-pin tool connector
- 12 4 Ethernet ports for 1 or 2 networks:

1 network  • Plug the Ethernet cable into any port.

2 networks  Ethernet network 1
 Ethernet network 2

 • Refer to "Appendix - Connections" to get more information.

 • For more information about installing Fieldbus modules, refer to the "Quick start user manual" part no. 6159931440 at <http://resource-center.desouttertools.com>.

2.4 - On receiving the controller

- Check the following items are included in the kit supplied with the controller.

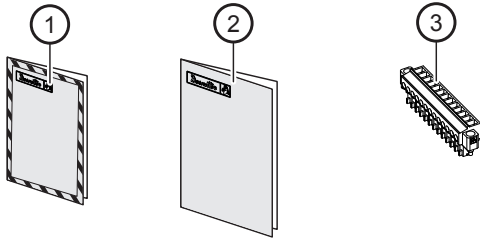

Legend

- 1 Safety booklet
- 2 Quick start user manual
- 3 2 cable clamps

2.5 - Installation

- To install and power the controller, follow the instructions listed in the Quick-start user manual 6159932290 supplied in the controller box.



The controller should be installed in such a way that it should be easily switched off.

The front panel LEDs are blinking and the Monitoring screen is displayed:



2.6 - Changing the controller language



- Tap this icon to display the main menu.

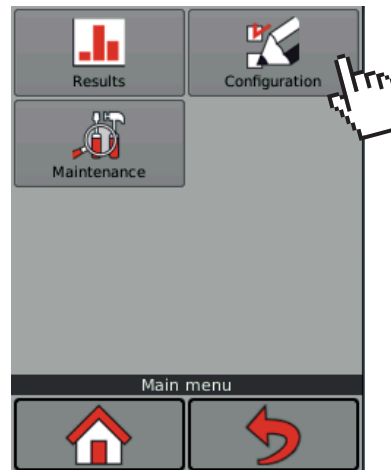

- Tap «Configuration / Controller / User interface / Language».

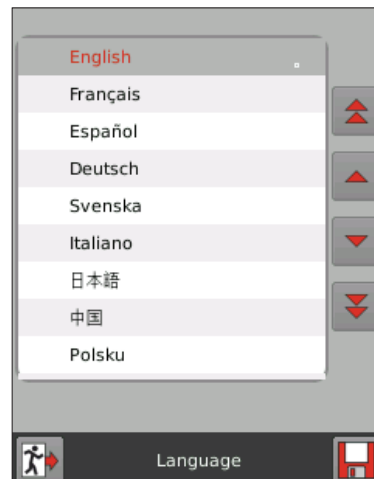













- Select your language by tapping the screen or the arrows.



- Tap this icon to save in the controller memory.

3 - CONTROLLER

3.1 - Using icons and keyboards

	to display the main menu.	
	to display the Monitoring view menu.	
	#	Selected Pset number.
	The tool is locked. • Tap the icon to show why the tool is locked.	
	to quit and return to the Monitoring screen.	
	to quit and return to the previous screen	
	to validate	
	to save in the controller memory	
	to quit without saving	
	the screen is locked	• Refer to chapter "Access manager".
	the screen is unlocked	
	<ul style="list-style-type: none"> Use the left, right or down arrow keys: - to navigate from one screen to another - to change the tool 	

- Use the text keyboard to write and customize the texts.

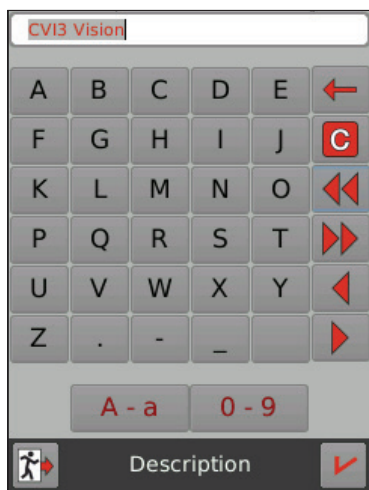

- Use the digital keyboard to enter the figures.



3.2 - Display

Path: Main menu / Configuration / Controller / User interface

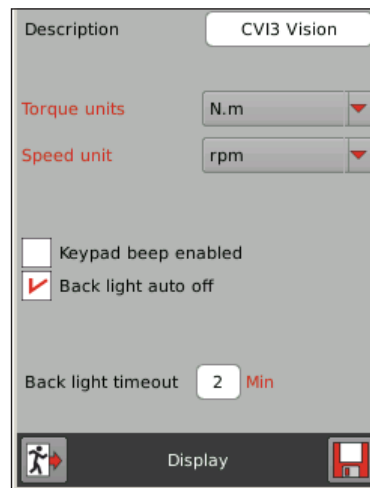

- Enter a description (up to 40 characters).

Torque unit	Nm, ft lb, in lb, kg m, kg cm, oz in.
Speed unit	rpm % of max tool speed
Keypad beep enabled	If selected, this function enables a "Beep" sound each time a button is pressed.
Back light auto off	The screen will be automatically turned off after the timeout. The screen will turn on as soon as: - the screen is touched - when a tightening result is displayed.
Back light timeout	The timeout value for the automatic back light switching off can be set between 1 and 60 min.

3.3 - Date & time

Path: Main menu / Configuration / Controller / User interface



This function is used to synchronize the controller date and time to ensure that the tightening results are stored with the correct date and time.

- Select the date and time format.
 - DD/MM/YY hh:mm:ss
 - YY/MM/DD hh:mm:ss
 - MM/DD/YY hh:mm:ss
- Tap the current date and time to display the time keyboard.
- Select year / month / day / time / hour / minute / second.
- Select the «Sync source» which will set the date and time in the controller.
 - None
 - CVI CONFIG
 - CVINet
 - Fieldbus
 - Ethernet protocol
 - Server NTP. Enter the server address.
 - Toolsnet

For example: If «Sync source» is set at «CVI CONFIG», the controller date and time will be updated during the data transfer from the software to the controller.

3.4 - Access manager

Path: Main menu / Configuration / Controller

It is recommended to protect the controller parameters against hazardous changes.



When the controller is delivered, the access manager is not activated and any modification can be done.

The padlock on the bottom left of the screen is open.

The «Access manager» menu is disabled (in grey).



To activate the access manager on the controller, you need to have a USB stick with the right profile (configured with the Desoutter CVIKEY software).

- If not, contact your CVIKEY manager for support.
- Connect your USB stick to the front panel of the controller.
- Tick «Access manager enabled» if you want the user to display the screens without modifying them.

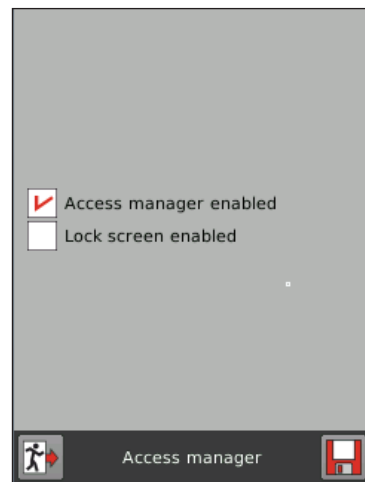

- Tick «Lock screen enabled» to lock the screen in Monitoring views.

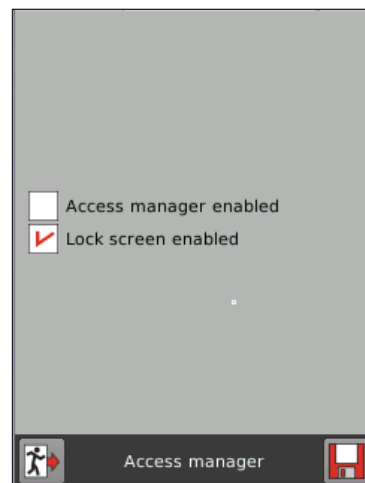

This icon will be then displayed on the top right of the Monitoring screen.

3.5 - Workgroup

Path: Main menu / Configuration / Controller

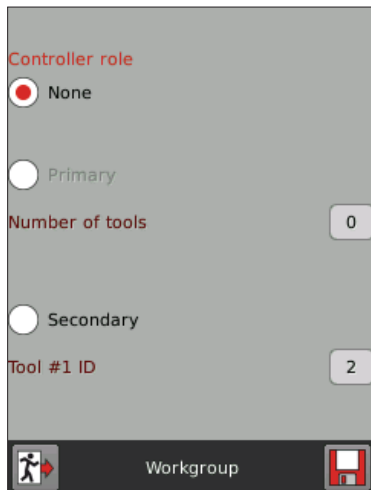

A workgroup is a system designed to drive from 2 to 14 fixtured tools with cable connection.

It is composed of a single primary controller and several secondary controllers. The primary controller drives the tools. It is also the unique access point for every communication interface used on the system.

3.5.1 - None (stand-alone)

- Click «None» to state that the controller is stand-alone.

3.5.2 - Primary controller

- Plug an ePOD3 into the bottom panel.
- Click «Primary» to state that the controller is selected as the primary controller of the workgroup.
- Select the number of tools of the workgroup (up to 14).



Ethernet ports 3 and 4 on the controller are not available anymore as they are from now dedicated to the workgroup network.

To continue working with CVI CONFIG, check that the PC Ethernet cable is connected to port 1 or 2.



- The setup of the workgroup is not done in the controller but in "CVI CONFIG" software (configuration of the master tool, creation of Psets per tools group).
- For more information, refer to the CVI CONFIG user manual at <http://resource-center.desouttertools.com>.

3.5.3 - Secondary controller

The controller is selected as one of the secondary controllers of the workgroup.

- Select the controller ID (position of the tool) in the workgroup.



When changing from "Secondary" to "None", the network configuration previously set for the stand-alone controller will be restored.



- Refer to "Appendix - Connections" to get more information.

3.6 - Serial / USB

Path: Main menu / Configuration / Controller / Peripherals



3.6.1 - Serial ports

The serial ports are used to communicate with external peripherals (barcode reader, DELTA measuring unit, etc...).



- As there is only one physical serial connector on the controller bottom panel, use the Y cable especially designed by Desoutter for serial ports - part no. 6159176200 if you want to use serial ports 1 and 2.

- Select an equipment for each serial port and fill in the data required for the exchange:

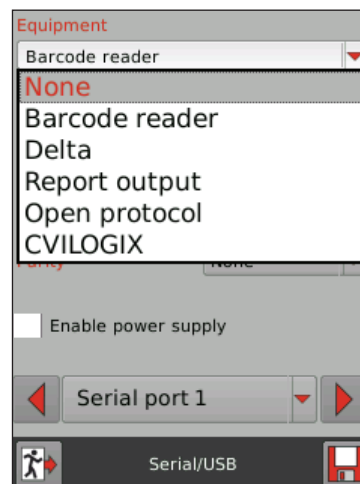

Baudrate	from 300 to 115200
Data bits	7 / 8
Stop bit	1 / 2
Parity	none / odd / even

- In case of a computer or serial printer, select «Report output» and then «PC4» or «CS5700».
- When the equipment is «Barcode reader», be sure that the barcode reader settings are «scanned data» + CR and LF terminators.
- Tick «Enable power supply» to provide 5V (pin 9) to a barcode reader for example.



- **To avoid damaging the equipment, make sure the settings are the same in the appliance, the controller and CVI CONFIG.**

3.6.2 - USB

- Select the equipment to connect to the USB ports. The setting is done automatically.
- When the equipment is «Barcode reader», be sure that the barcode reader settings are «USB keyboard emulation USA».

3.7 - Networks

Path: Main menu / Configuration / Controller / Peripherals



1 network		• Plug the Ethernet cable into any port.
2 networks		Ethernet network 1
		Ethernet network 2

- Enter the network name (up to 40 characters).
- Enter the controller IP address, Subnet mask, Gateway and MAC address parameters.

3.8 - Fieldbus

Path: Main menu / Configuration / Controller / Peripherals

- Select the type of Fieldbus according to the Fieldbus module installed in the controller.

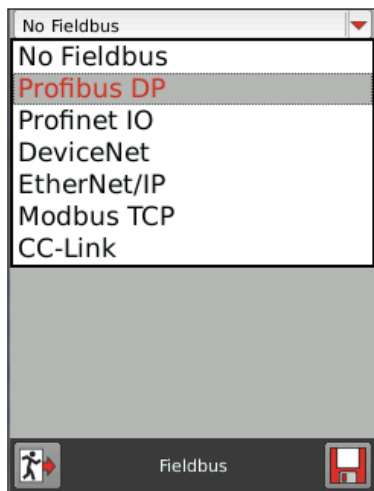

- Fill in the screens.

For example:



- For more information about how to setup Fieldbus, refer to the CVI CONFIG user manual at <http://resource-center.desouttertools.com>.

3.9 - Customized protocol

Path: Main menu / Configuration / Controller / Peripherals

- Plug the «PFCS» ePOD into the bottom panel of the controller.



- For more information about installing the ePOD, refer to the installation manual" part no. 6159931050 at <http://resource-center.desouttertools.com>.

- Click «Customized protocol».
- Tick «Customized protocol activated» to activate the connection to the controller and check the ePOD is present.

A new screen is then displayed.

- Tick the box on the top left to activate the protocol.
- Fill in the parameters.

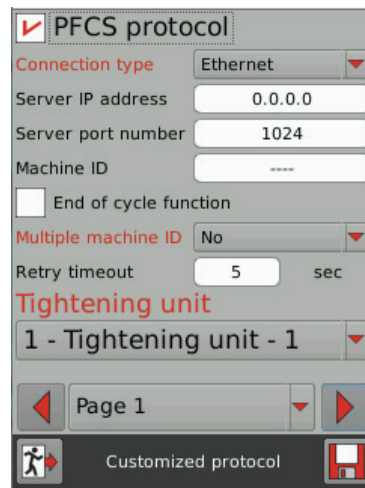

- Use the left, right or down arrow keys to display the next page.

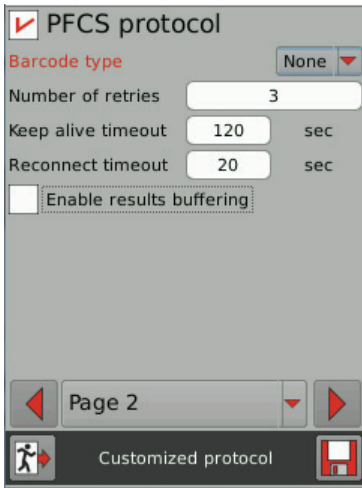

- For further information, contact your Desoutter representative for support.

3.10 - CVINet

Path: Main menu / Configuration / Controller / Peripherals

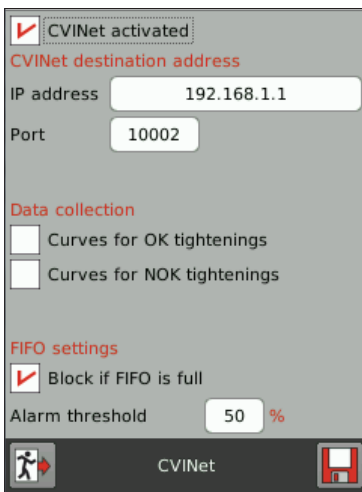

- Tick «CVINet activated».
- Enter the IP address of the server where CVINet software is installed.
- Fill in the data required for the exchange.

Data collection	<ul style="list-style-type: none"> • Select the data you want to collect: <ul style="list-style-type: none"> - Curves for OK tightenings - Curves for NOK tightenings.
FIFO settings	The controller regularly sends results to CVINet. The purpose is to provide a full traceability even when the network connection is unstable.
Block if FIFO is full	1. The controller is able to keep a defined number of results previously generated by each tightening unit (typically 10,000). The alarm threshold corresponds to the percentage of these results that have not been sent to the server and stored in CVI3 FIFO memory.

	2. When option "Block if FIFO is full" is enabled, a tightening unit is locked when the FIFO level is 100%. It allows to ensure traceability of all generated results. The tightening unit is unlocked when connection is re-established and FIFO level is under 100%. When disabled, no lock is set when FIFO level is 100%, and traceability of all results is not ensured.
Alarm threshold	The value of "Alarm threshold" sets the level of the FIFO that triggers an alarm message on the controller display and set the "Reporting alarm" output event. The controller is not locked by this alarm. The alarm informs on possible communication issues with the server. Maintenance operators can solve the issue before the controller is locked (if option "Block is FIFO is full" is enabled), or before traceability of some results is lost (if option "Block is FIFO is full" is disabled).

3.11 - Remote display

3.11.1 - PC/Windows

- Use «TightVNC» which is a free remote control software package, to see the display of the controller and control it with your local mouse and keyboard.
- Go to the website «<http://www.tightvnc.com>» and follow the instructions.
- Once the software is downloaded, go to «Start», «All programs», «TightVNC» folder and click «TightVNC Viewer».

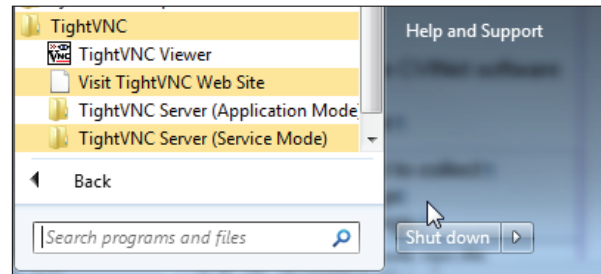

- Enter the controller IP address and click «Connect».

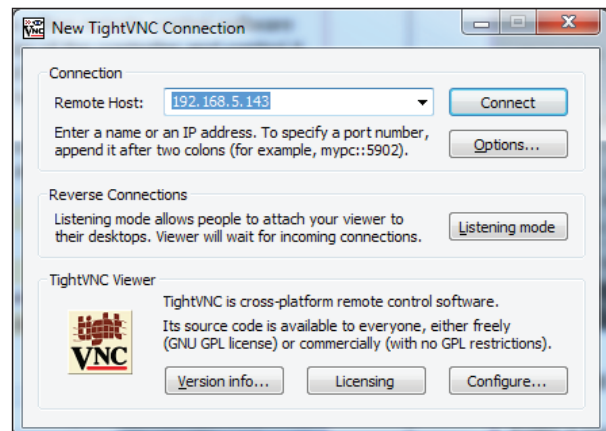

You can now control the controller from your PC.



- Go to the App store and download the free app «Mocha VNC Lite».
- In the app, create a new configuration and enter the IP address of the controller in the box «VNC server address».

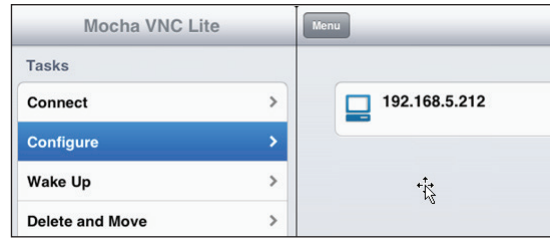

- Click «Connect».

You can now control the controller from your device.

3.11.3 - Android

- Install the free application «bVNC» on your device.
- The process is the same than for the Apple device.

3.11.2 - Apple

- Install the free application «Mocha VNC Lite» on your device.
- Set up a Wi-Fi access point connected to the controller.
- Set up the SSID / Password
- Set up the IP address of the access point and connect it to the controller.
- Check the IP address of the controller.
- On your Apple device, configure the Wi-Fi network.



- Connect to the SSID of the controller access point.
- Go then on details view.



- Move from DHCP to Static.
- Put an IP address for your device and a subnet mask in relation with what has been made for the controller.

Your device can now talk to the controller.

4 - TIGHTENING UNIT

Path: Main menu / Configuration / Tightening unit



- Tap this icon to start the Tightening Unit setup.

4.1 - General

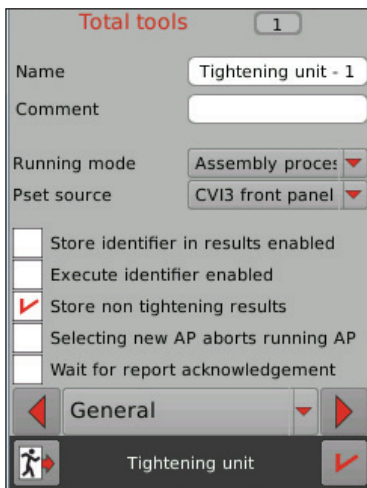

4.1.1 - Add a name and a comment

- Enter a name (up to 40 characters) and a comment (up to 100 characters).
- Use the text keyboard to write and customize the texts.

4.1.2 - Running mode selection

- Select the «Running mode» according to your assembly configuration:

Pset	The tightening unit will run accordingly to the selected Pset.
Assembly Process	The tightening unit will run according to the selected Assembly Process.

4.1.3 - Pset selection source

- Select the Pset selection source:
 - I/O
 - CVI3 front panel
 - CVILOGIX
 - Open Protocol
 - Fieldbus
 - Socket tray
 - Tool display (this source is available for wireless battery tools only)

4.1.4 - Options

Store identifier in results enabled	• Tick this option to record one or more identifiers in the tightening results. Refer to CVI CONFIG software to set up the identifiers.
Execute identifier enabled	• Tick this option to trigger an action linked to the reception of an identifier. Refer to CVI CONFIG software to change the identifier.
Store non tightening results	• Tick this option to record results other than tightening results in the controller memory, e.g. run reverse results, batch increment results.
Wait for report acknowledgement	• Tick this option to lock the tool with cable connection at the end of a tightening. The tool will be unlocked when the "Wait for report acknowledgement" event is activated.



The function "Selecting new AP aborts running AP" is available in the Assembly Process running mode only. Refer to CVI CONFIG software to see the settings in details.

- Use the left, right or down arrow keys to display the next screens.

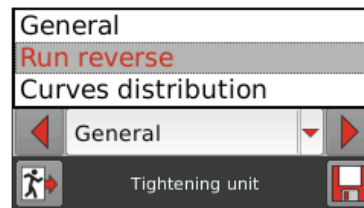

4.2 - Run reverse parameters



- Select the «Reverse mode» to reverse the tool direction before starting.

Reverse once	Pushing the reverse button, the reverse direction is selected; the tool starts in reverse direction when the operator presses the start trigger. Once the tool has run, the tightening direction is automatically re-activated.
Alternate	Pushing the reverse button, the reverse direction is selected. The tool starts in reverse direction when the operator presses the start trigger. Pushing again the reverse button, the tightening direction is selected.
Reverse disabled	The reverse direction is not possible.
Double hit	<ul style="list-style-type: none"> • Quickly press the reverse button twice in order to switch from the tightening direction to the reverse direction (and vice versa).

- Fill in the following values:

Speed	% or rpm of max.	This can be used for any run reverse operation (except for a Pset loosening step).
Min. torque and Min. Angle	Nm Deg	These will allow to detect a real loosening of the assembly. The "Fastener loosened" output event is activated.
Maximum time	s	Maximum loosening duration. The tool stops automatically after this time.
Max. number of turns	0-999	Maximum loosening turns from trigger start. The tool will stop automatically when this number is reached.

4.3 - Options on «Reject report»

This option will prevent the operator from performing another tightening operation after a NOK report.



- Select one of these options to unlock the tool and allow the operator to do tightenings again.

Input unlock	by actuating the "Error Acknowledge" input event.
Reverse direction unlock	by pushing the run reverse button or selecting the reverse direction.
Run reverse unlock	by performing a run reverse with programmed run reverse min. torque and angle reached.

4.4 - Curves distribution

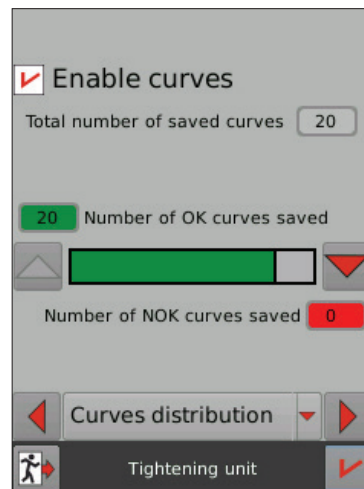

- Select your own curve distribution by sliding the cursor. The maximum number of curves displayed depends on the model of ePOD connected.
- Tick the box to enable or disable the curves generation.



- To select the number of points to store in the curves (2,000 by default or 500 points), launch "CVI CONFIG" software and go into the configuration of the tightening unit.

4.5 - Wireless battery tool management



- Tap this icon to create the Tightening Unit no. 51 which is dedicated to the wireless battery tool.



- Tap this icon to start the Tightening Unit setup.

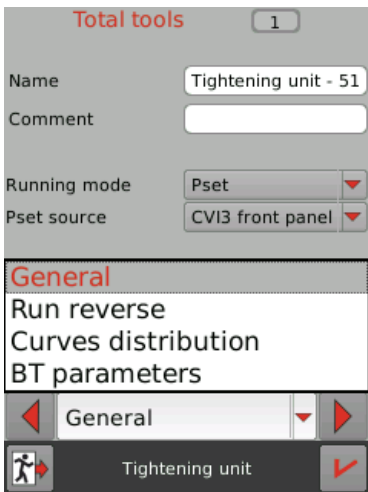

- Refer to the previous chapters to set up the general features, the run reverse and the curves parameters.

4.6 - Wireless battery tool parameters

This chapter will show how to customize the environment and the display of the wireless battery tool.

- Tap «BT parameters» to display the sub-menus.

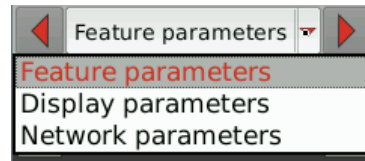

4.6.1 - Feature parameters

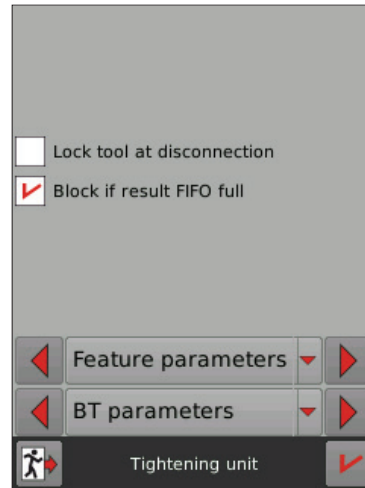

Lock tool at disconnection	disabled	The wireless battery tool is not locked when the communication is lost with the controller.
	enabled	The wireless battery tool can be locked when the communication is lost with the controller.
		The lifetime value defines the maximum time the tool is able to work without controller communication.
Block if FIFO is full		The wireless battery tool is able to keep a defined number of results previously generated (typically 10,000). When option "Block if FIFO full" is enabled, the wireless battery tool is locked when FIFO level is 100%. It allows to ensure the traceability of all generated results. The tool is unlocked when the connection is re-established and FIFO level is under 100%. When disabled, no lock is set when FIFO level is 100% and traceability of results is not ensured.

4.6.2 - Display parameters

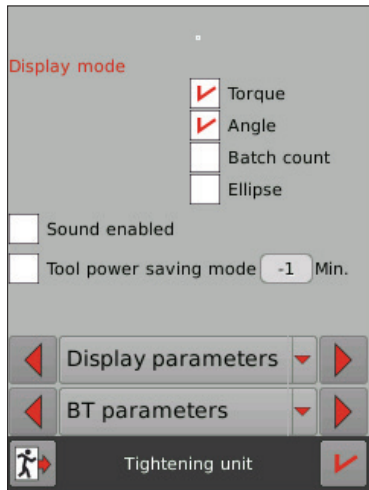

Display mode	Torque	Torque & angle results are on the tool display.
	Angle	Torque & angle results are on the tool display.
	Batch count	Batch count and batch size are on the tool display (xx/xx).
	Ellipse	The Assembly Process ellipse is on the tool display.
Sound enabled	<ul style="list-style-type: none"> Click to enable the parameter. Voice messages and beeps have been created to alert the operator in case of problems or events that may happen during the tightening operation. 	
Tool power saving mode	Tool display standby	After 2 minutes, the wireless battery tool display switches off.
	Communication standby	The wireless battery tool communication with the controller goes down. <ul style="list-style-type: none"> Set the value between [5;60].
	Power off	25 minutes later, the wireless battery tool powers off.
	<ul style="list-style-type: none"> Enter "0" to keep the communication always active. The wireless battery tool will never power off. 	

4.6.3 - Network parameters

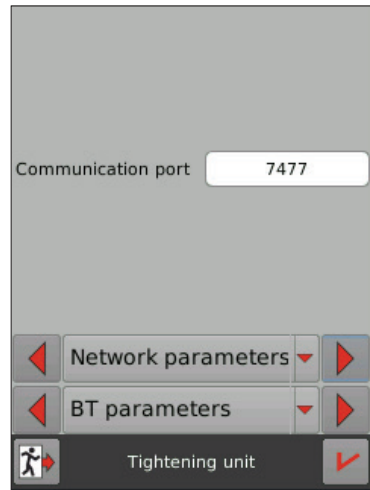

Communication port	<p>The communication port is used by the controller to communicate with the wireless battery tool. 7477 by default.</p> <ul style="list-style-type: none"> In the WI-FI configuration of the battery tool, check that the communication port is the same. Refer to the CVIMONITOR user manual at http://resource-center.desouttertools.com.
--------------------	---

5 - TOOL

Path: Main menu / Configuration / Tool

This part shows the configuration of each connected tool. It may be different according to the tool model.

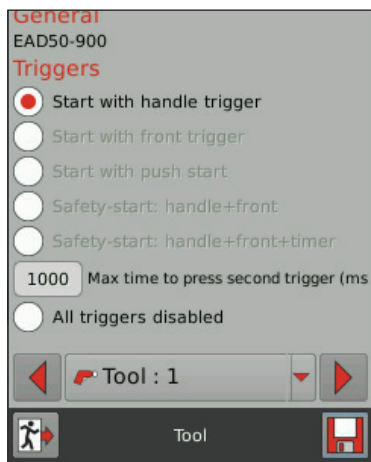

5.1 - Tool 1

Tool 1 is the name of the tool with cable connection.

- Select how to manage the triggers.

Start with push start	<ul style="list-style-type: none"> • Press the tool against the screw to start the tightening operation.
Safety-start: handle + front	<p>This mode means that the operator has to press two triggers at the same time to perform the tightening operation.</p> <p>The purpose is to ensure that the operator has both hands on the tool before triggering.</p>
Safety-start: handle + front + timer	<p>This mode forces the operator to press the 1st trigger and then the 2nd trigger in a defined time.</p> <ul style="list-style-type: none"> • Enter the max. time in ms. When this time is reached and the second trigger is not pressed, the tool will not start.
All triggers disabled	<ul style="list-style-type: none"> • Tick this mode to disable all triggers. The only possibility to start the tool is to use the external input event (Start/stop tightening) and in that case, the tool trigger must be pressed and locked.
	<ul style="list-style-type: none"> • Use the Desoutter «Trigger locker» part no. 6153978420 to have the tool trigger pressed continuously.

5.2 - Tool 51

Tool 51 is the name of the wireless battery tool.

When the tool is connected to the controller, the tool model is displayed.

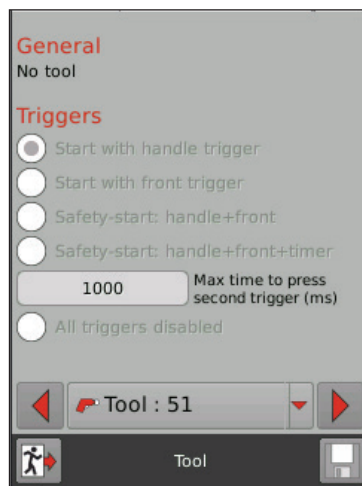

6 - PSET

Path: Main menu / Configuration / Pset



A Parameter set is commonly called Pset and shown by this icon.

A Pset is combining one or several steps, each step describing a function. The tool will execute the steps one after the other in the given order. Content of the steps and the order can be changed at any time.

The minimum to run the tool is 1 Pset containing 1 step.

There are up to 250 Psets per tightening unit.

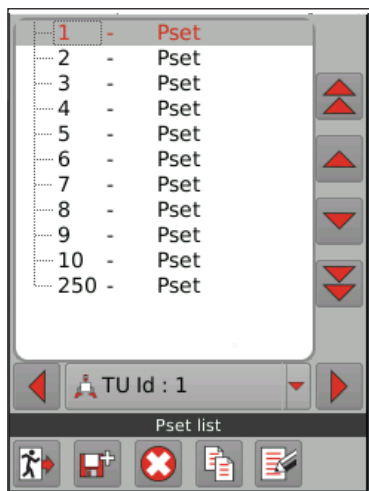

	to go to the first Pset
	to go to the previous Pset
	to go to the next Pset
	to go to the last Pset



• Once the programming is done, tap this icon to save the changes in the controller and quit the screen.

6.1 - How to add a Pset



• Select first the Tightening Unit. The list of Psets can be different per Tightening Unit.



• Tap this icon to add a Pset.

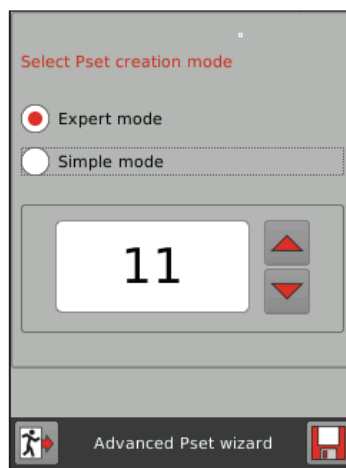

6.1.1 - Expert mode

• Tap «Expert mode» to create a new Pset and add it in the list of Psets.

6.1.2 - Simple mode

- Tap «Simple mode» to create a new Pset and quickly set it up.
- Use the left, right or down arrow keys to display the next screens.
- Enter the Target torque.
- Customize the Pset name.

The tightening strategy is «Torque control».

Tolerances, curves and speeds are automatically calculated.

6.2 - General



In the list of Psets, tap this icon to edit a Pset.

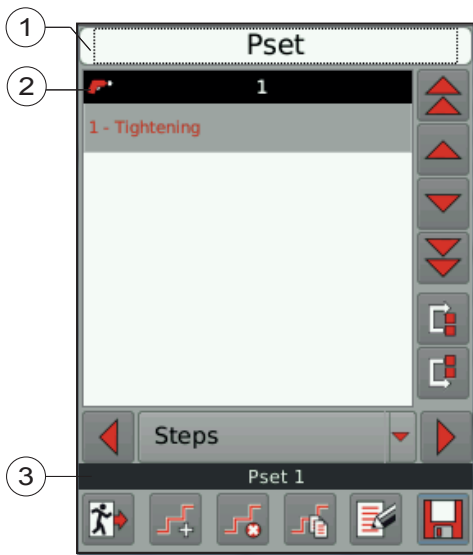

Legend

- 1 Pset name
- 2 Tool no. 1
- 3 Pset number

- Use the left, right or down arrow keys to display the next screens.

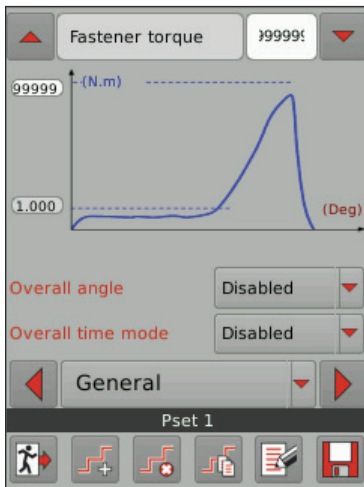

- Tap anywhere on the screen.

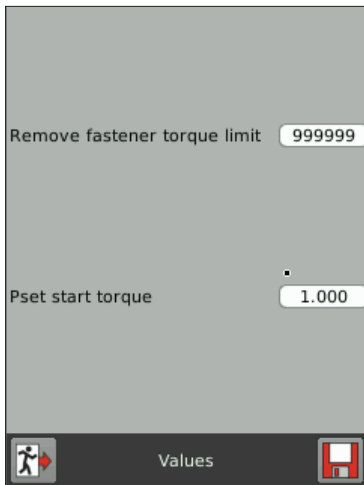

6.2.1 - Remove fastener torque limit

The «Remove fastener torque limit» is the torque limit above which the fastener (bolt and screw) may have suffered damage and must be replaced. By default, the value is set to 120% of the target torque. This torque value may lie above the maximum tool torque.

6.2.2 - Pset start torque

The «Pset start torque» is the torque value that must be reached to declare the Pset as started. Below this value, neither result or report will be generated.

6.2.3 - Overall angle mode

The «Overall angle» can be measured during the complete tightening operation, i.e. starting at the overall angle threshold until the end. This option excludes the use of «Overall time mode».

Disabled	The overall angle is not measured.
Monitoring	The overall angle is checked at the end of the Pset execution.
Control	If the overall angle gets out of limits, the report of the tightening operation is NOK and the tool stops.

6.2.4 - Overall time mode

The «Overall time» can be measured during the complete tightening operation, i.e. starting at the overall time threshold until the end. This option excludes the use of «Overall angle mode».

Disabled	- the overall time is not measured.
Monitoring	- the overall time is checked at the end of the Pset execution.



If the «Overall time» gets out of limits, the report is NOK.

6.3 - General 2



6.3.1 - External stop abort Pset

When the input event «External stop abort Pset» is activated, the Pset automatically stops.

The execution conditions can be as follows:

	on rising edge
	on falling edge
	on change (rising or falling)
	on high level
	on low level

6.3.2 - Thread direction

- Select the thread direction of the screw.

	clockwise
	counterclockwise

In the «Run reverse» mode, the tool rotates in the opposite direction of the «Thread direction».

This selection has no effect on the rotation direction of the tool motor in the Pset.

- Refer to chapter «7.6 - Motor control» to set up the rotation direction of the motor.
- Go to the «Pset start / stop» screen by tapping the left or right arrow.

6.3.3 - Additional sensor

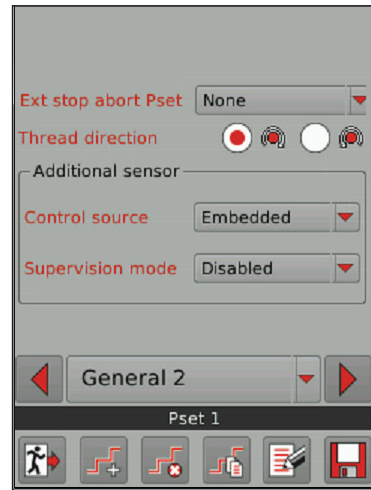

When an additional transducer is detected on the tool, the tab "Additional transducer" is automatically displayed.

- Select the transducer which will be used to control the tightening operation during the Pset.

Embedded transducer	The embedded transducer is the main transducer of the tool and it is assembled at the factory.
Additional transducer	The additional transducer is an accessory and is mounted by the customer himself.

- Select the supervision mode:

Disabled	No comparison is done.
Consistency mode	The drift between both transducers is measured during the tightening operation. The tightening process stops when the drift is greater than the tolerance values set. Control transducer values are highlighted on display.
Redundancy mode	The tightening report comparison is made between both transducers when the tightening operation is completed. Two reports OK are required to achieve a global result OK. Monitoring transducer values are highlighted on display.



The results and curves are displayed in "CVI MONITOR" software.

- Refer to the user manual of CVI MONITOR available at <http://resource-center.desouttertools.com>.

6.3.4 - Pset start/stop

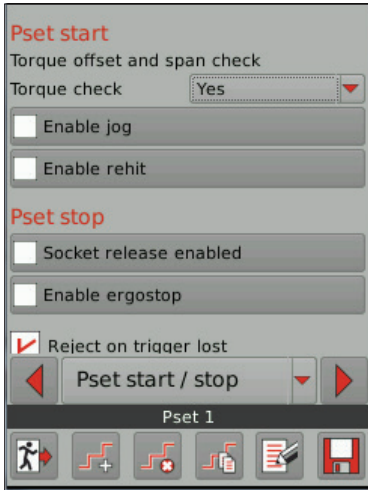

6.3.5 - Torque transducer offset and span check

If yes, the torque transducer offset value will be checked at each Pset start and a span test will be performed. It is recommended to set this parameter to «Yes» to clear the torque transducer offset and to check the span drift.

6.3.6 - Reject on trigger lost

The tightening report will be declared as NOK if the start signal is released before the target is reached.

- Tick this option: yes / no.

If yes, the Pset is rejected if the start signal is released before the end of the tightening operation.

If no, the report is only based on trend (the start signal is not taken into account in the report calculation).

6.3.7 - Jog

This function helps to fit the tool socket onto a bolt.

When enabled, the tool turns a given «rotation angle» in a specific direction (forward, reverse or alternate) and repeatedly (n times).

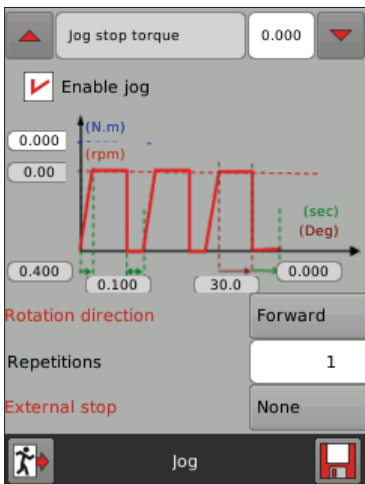

- Tick the box on the top left to activate the function.

6.3.8 - Rehit

This function is used to detect that a joint has been re-tightened.

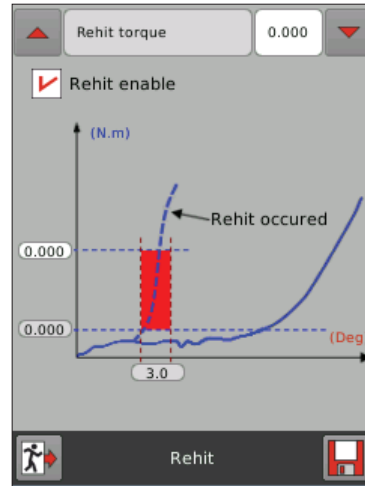

The conditions for rehit are:

- the «Rehit» function is enabled
- AND
- the Rehit torque is reached before having reached the Rehit angle.

i.e.: $\text{Angle} * \leq \text{Rehit angle}$

$$* \text{ angle} = \text{angle}_{\text{rehit torque}} - \text{angle}_{\text{rehit threshold}}$$

- Tick the box on the top left to activate the function.

6.3.9 - Socket release

This function is used to release the constraint between the socket and the screw. When relaxation is enabled, the tool rotates in reverse a few degrees in order to easily remove the socket.

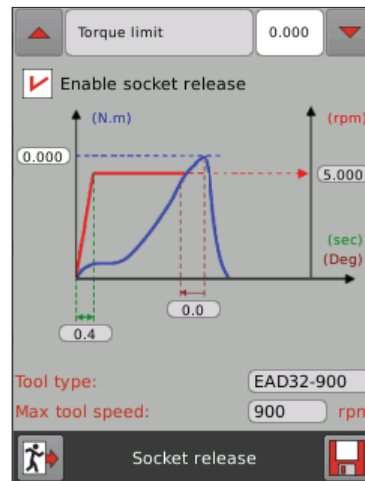

- Tick the box on the top left to activate the function.

6.3.10 - Ergostop

This option allows for a smoother tool stop in order to reduce torque reaction on the operator.

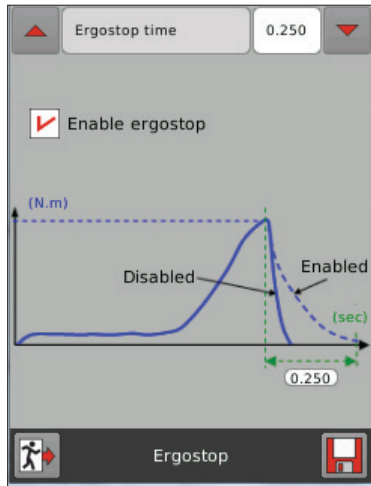

- Enter the time of the braking phase: from 0.01 to 1 second.
- Tick the box on the top left to activate the function.

6.4 - Curves

- Select the type of curves recording performed by the controller.

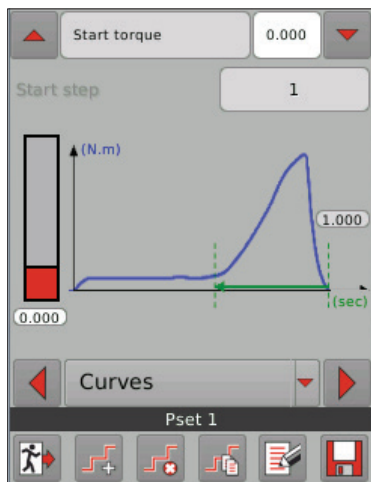

- Tap anywhere on the screen to select:

Start torque	<p>The torque and angle values are saved from the start torque till the end of the tightening during a set time.</p> <p>If the start torque is > 0, a forward recording is executed from a defined step number during a maximum time.</p> <p>If the start torque = 0, a backward recording is executed in a sliding window in a defined period.</p>
Time	<p> A curve has a maximum of 2,000 points.</p> <p>The longer the recording time is, the less accurate the curve is.</p>

Offset display

For a better reading of the results, it is possible to have the offset displayed or not (for example: Prevailing offset mode set to "Add").

- Launch "CVI CONFIG" software, select the Pset and tick "Apply offset in curve" in the "Curves" tab.

Example of display in CVIMONITOR:

With offset applied:

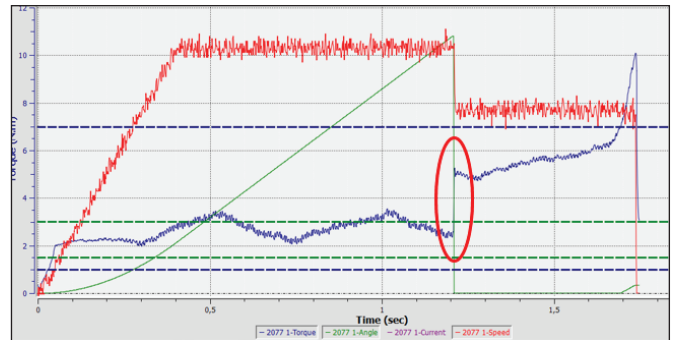

Without offset applied:

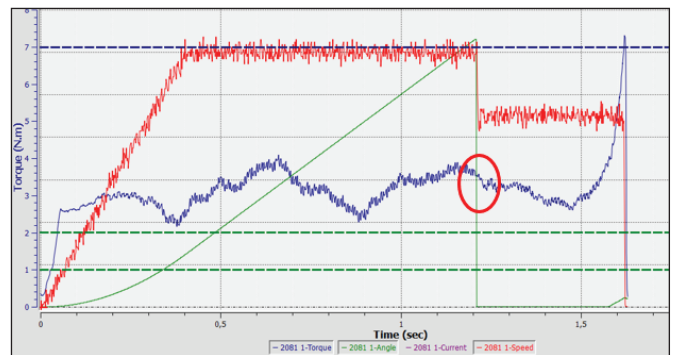

6.5 - Pset coefficients



The torsion coefficient allows to compensate a possible mechanical torsion of an extension of tool or crowfoot (to be used only when tightening with target angle).

$$0.000 \leq \text{Torsion coefficient} \leq 1.000$$



This coefficient can be measured on the curve registered on the machine from the back torsion angle and the torque reached.

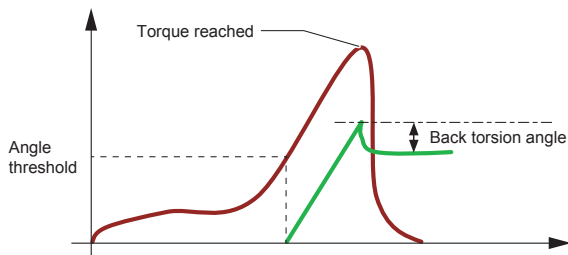

$$\text{Coefficient} = \frac{\text{Target angle} - \text{Final angle}}{\text{Final torque} - \text{angle threshold}}$$

Example:

Target Angle	100°
Final Angle	97°
Angle threshold	20 Nm
Final Torque	120 Nm

$$\text{Coefficient} = \frac{(100 - 97)^\circ}{(120 - 20) \text{ Nm}} = 0.03^\circ/\text{Nm}$$

- Tick the box on the top left to activate the function.

6.6 - How to copy / paste / delete a Pset

	Copy	• Select first a Pset in the list of Psets.
	Paste	
	Delete	

7 - STEP

A Parameter set is composed of one or several steps run consecutively, up to 15 steps per Pset.

Each step is defined by main parameters, tightening instructions and motor settings.



A step is shown by this icon.

The «Tightening step» is displayed by default.

7.1 - How to add/organize the steps

Path: Main menu / Configuration / Pset



- Connect the tool to correctly adjust the parameters.

- Go to the list of Psets and select a Pset.

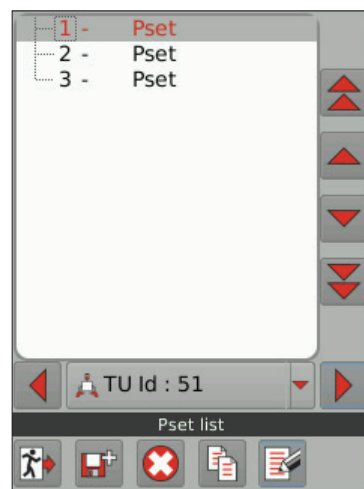





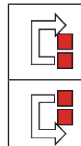
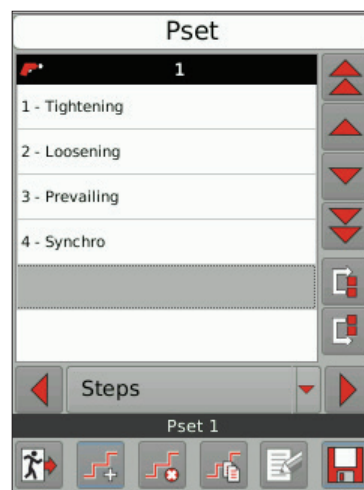



- Tap this icon to add a new step.

Example of steps:



to move up and down a step.

	to delete a step
	to copy a step
	to edit a step.

	• Use the following icons to navigate from one screen to another:
	<div style="border: 1px solid black; padding: 5px;"> <p>Control</p> <p>Monitor</p> <p>Options</p> <p>Motor control</p> <p>General</p> </div>
	
	
	to save in the controller memory

- Tap «1. Tightening».

The goal is to select the steps, organize their order and the possible synchronization.

 The first tightening step cannot be deleted.



- Tap «Rotation» to select the following steps:
 - Tightening
 - Loosening
 - Prevailing
- Tap «Synchro» to sync the rotation steps.
- Tick «Before» or «After» to insert the new step before or after the step highlighted.

Now the target is to define each step in details and set up parameters according to the tightening application.

7.2 - General

 The general parameters are common to all tools.

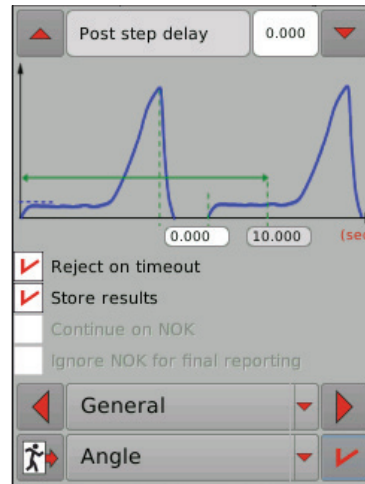

- Tap «General»:



Post step delay	This is the time required before executing the next step.
Max. time	This is the maximum step duration (10 s by default).
Reject on timeout	• Tick the box to declare the step NOK when the time is exceeded.
Store results	• Tick the box to record the step in the tightening results.

 By default, only the last step executed is stored in the results.

Continue on NOK and Ignore NOK for final reporting

Step number	Step report	Continue on NOK	Ignore NOK for final reporting
		The Pset tightening will continue even if the step report is NOK.	The NOK step will not be taken into account to generate the Pset report.
Example no. 1			
1	 NOK	<input checked="" type="checkbox"/> on	- off
2	 NOK	- off	- off
3	-	- off	- off
Tool Pset report		 NOK	

Step number	Step report	Continue on NOK		Ignore NOK for final reporting	
		The Pset tightening will continue even if the step report is NOK.		The NOK step will not be taken into account to generate the Pset report.	
Example no. 2					
1	OK	-	off	-	off
2	NOK		on	-	off
3	OK	-	off	-	off
Tool Pset report		NOK			
Example no. 3					
1	NOK		on		on
2	OK	-	off	-	off
3	OK	-	off	-	off
Tool Pset report		OK			

7.3 - Tightening

- In the list of steps created for tool no.1, tap «Tightening».



- Tap this icon to edit the step.

- Use the left, right or down arrow keys to navigate from one screen to another.
- Select the type of control:
- Tap anywhere on the curve to display the screen of values.
- Fill in the values.

7.3.1 - Torque control

A torque control strategy coupled with an angle monitoring is adapted for most assemblies.

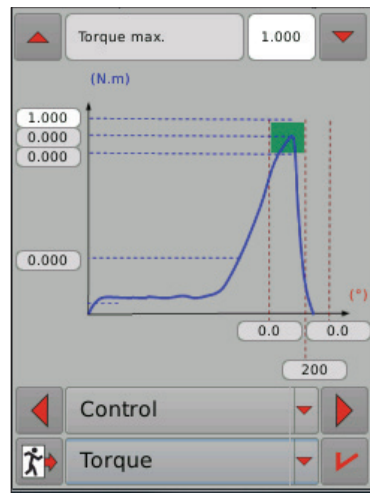

Stop conditions

IF Torque \geq Target torque
OR Angle $>$ Abort angle

Report OK	IF Min torque $<$ Peak or Final Torque $<$ Max torque AND IF Min angle $<$ Peak or Final Angle $<$ Max angle
-----------	--

For each channel, the 3 report controller LEDs will light according to the following diagram.

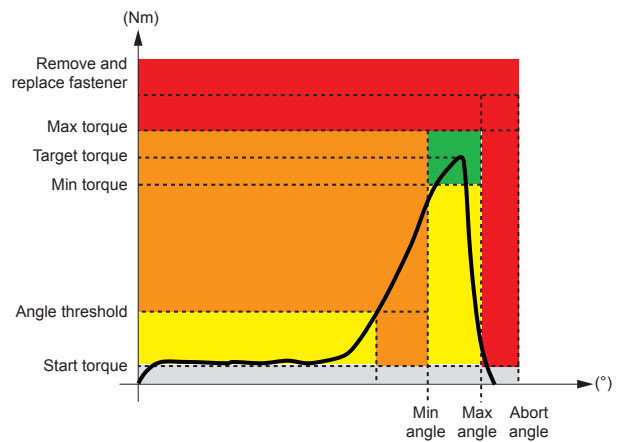

Result data	Peak OR Final torque Peak OR Final angle
-------------	---

7.3.2 - Angle control

A tightening angle control strategy is adapted for assemblies requiring tension accuracy.

This strategy provides a better control of the tension and a better repeatability and accuracy than the torque control strategy.

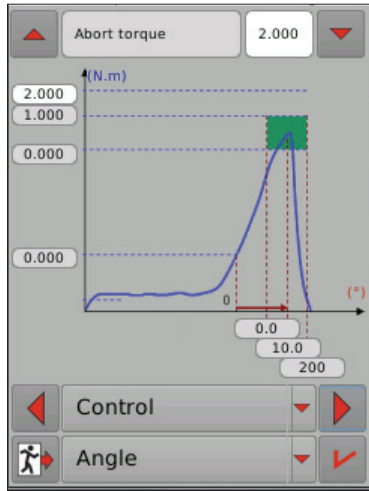

Stop conditions	
IF Angle \geq Target angle	
OR IF Torque \geq Abort torque	

Report OK	IF Min torque < Peak or Final Torque < Max torque AND IF Min angle < Peak or Final Angle < Max angle
-----------	--

For each channel, the 3 report controller LEDs will light according to the following diagram.

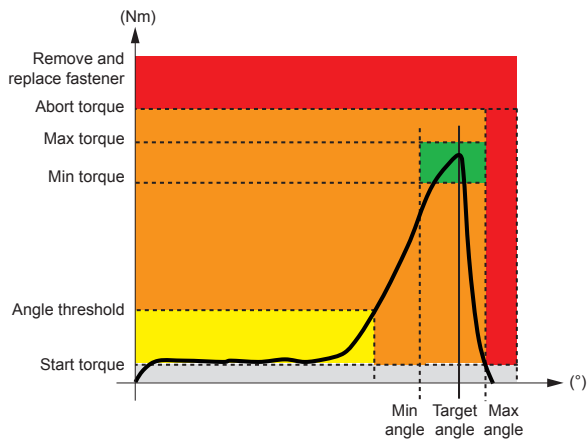

Result data	Peak OR Final torque Peak OR Final angle
-------------	---

7.3.3 - Torque OR angle control

The tightening torque OR angle control strategy is adapted for assemblies requiring tension accuracy.

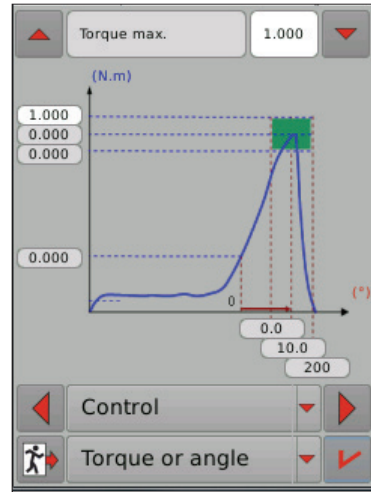

Stop conditions	
IF Torque \geq Target torque	
OR IF Angle \geq Target angle	

Report OK	IF Min torque < Peak or Final Torque < Max torque AND IF Min angle < Peak or Final Angle < Max angle
-----------	--

For each channel, the 3 report controller LEDs will light according to the following diagram.

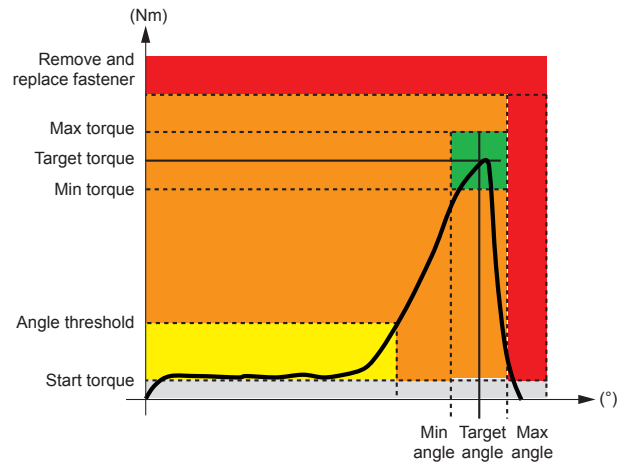

Result data	Peak OR Final torque Peak OR Final angle
-------------	---

7.3.4 - Torque AND angle control

The tightening torque AND angle control strategy is adapted for assemblies requiring tension accuracy.

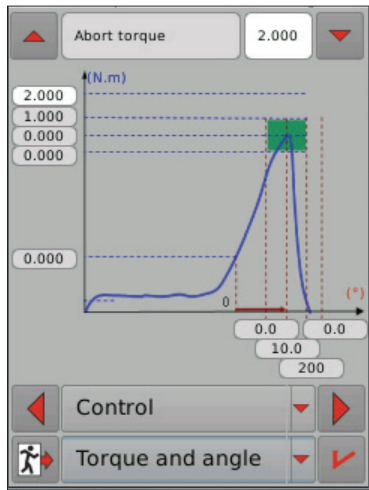

Stop conditions	
IF Torque \geq Target torque AND Angle \geq Target angle OR IF Torque \geq Abort torque OR IF Angle \geq Abort angle	

Report OK	IF Min torque < Peak or Final Torque < Max torque AND IF Min angle < Peak or Final Angle < Max angle
-----------	--

For each channel, the 3 report controller LEDs will light according to the following diagram.

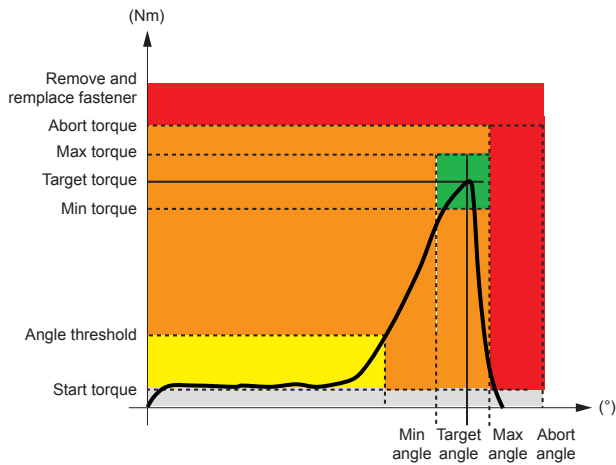

Result data	Peak OR Final torque Peak OR Final angle
-------------	---

7.3.5 - Yield point control



- Launch CVI CONFIG software to setup this strategy.
- For more information, refer to the CVI CONFIG user manual at <http://resource-center.desouttertools.com>.

7.3.6 - Seating detection



- Check an ePOD2 is connected to the controller.



- Launch CVI CONFIG software to setup this strategy.
- For more information, refer to the CVI CONFIG user manual at <http://resource-center.desouttertools.com>.

7.4 - Monitoring & options

For all control strategies, torque and angle are systematically monitored.

For torque and angle monitoring, it is possible to choose either the peak value or the final value to be monitored. Generally, the peak value is used for the torque and the final value for the angle.

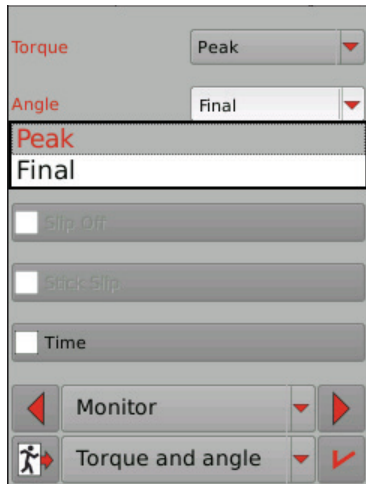

- Select torque and angle monitorings: peak/final
- Tick one or more monitorings.

7.4.1 - Current monitoring

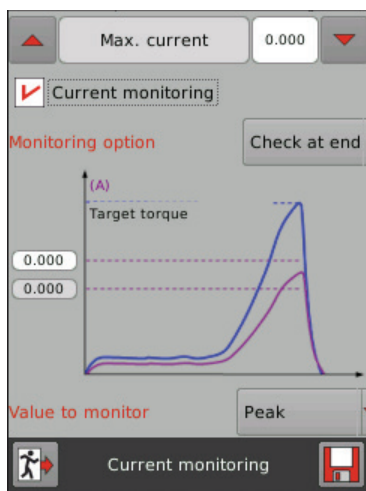

The «Current / check at end» monitoring checks the current value when the target torque is achieved depending on Peak or Final torque monitored.

The monitored value can be «Peak» or «Final».

Report OK	IF Min current < Current < Max current.
-----------	---

- Fill in the values.

7.4.2 - Time monitoring

The time monitoring is made to frame the tightening operation duration.

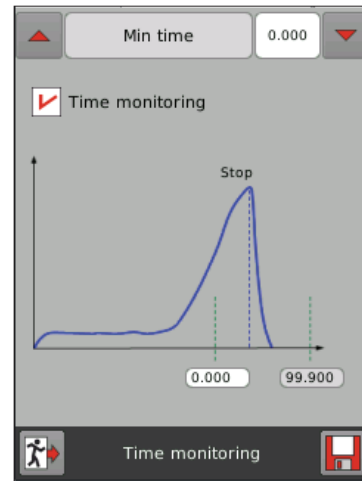

A step duration can last from 0 to 600 sec.

- Fill in the values.

7.5 - Step options

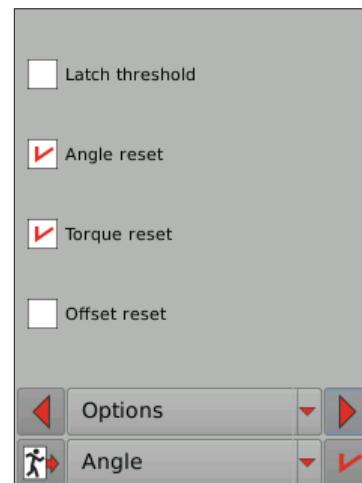

7.5.1 - Angle reset

- Tick this option to reset the angle measurement at the beginning of the step.

7.5.2 - Torque reset

- Tick this option to reset the torque measurement at the beginning of the step.

7.5.3 - Offset reset

- Tick this option to reset the «Prevailing torque offset» at the beginning of this step.

7.5.4 - Latch threshold

The controller starts measuring the angle when the torque crosses the angle threshold for the first time.

When this option is ticked, the measure then continues till the end even if the torque becomes below the threshold. The measured angle is therefore closed to the real angle.

When this option is not ticked, the controller stops counting the angle when the torque falls below Angle threshold.

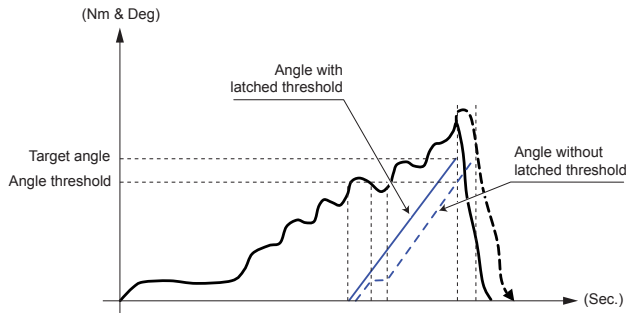

7.6 - Motor control

7.6.1 - 2 speed

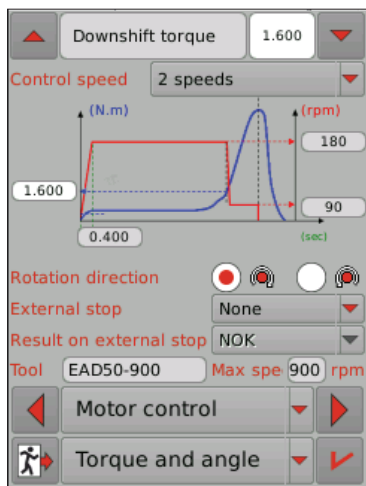

Starting at the start signal, the tool runs with a programmed acceleration up to Rundown speed. The tool keeps running at Rundown speed. Once Downshift torque has been reached, the speed changes to Downshift speed.

Parameters

Acceleration time	Time to increase speed from 0 to Rundown speed.
Rundown speed	Speed applied from start to downshift torque to optimize productivity
Downshift torque	Torque where speed moves from Rundown to Downshift speed.
Downshift speed	Speed applied from Downshift torque to motor stop to optimize quality.
Rotation direction	Clockwise / Counterclockwise

7.6.2 - 3 speed - ergospeed

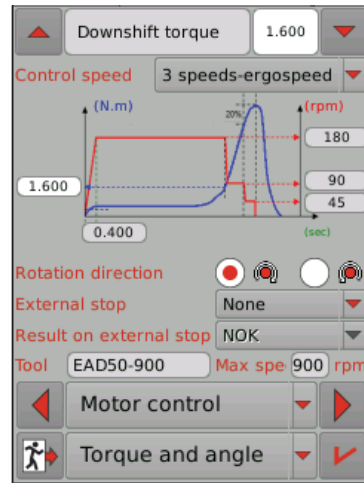

Starting at the start signal, the tool runs with a programmed acceleration up to Rundown speed. The tool keeps running at Rundown speed. Once Downshift torque has been reached, the speed changes to Downshift speed. Once 80% of the Target torque has been reached, the speed changes to Final speed.

Parameters

Acceleration time	Time to increase speed from 0 to Rundown speed.
Rundown speed	Speed applied from start to downshift torque to optimize productivity
Downshift torque	Torque where speed moves from Rundown to Downshift speed.
Downshift speed	Speed applied from Downshift torque to the 2nd Downshift to break inertia or very hard joints.
Final speed	Speed applied from the 2nd Downshift (80% of Target torque) to motor stop (to optimize quality on very hard joint).
Rotation direction	Clockwise / Counterclockwise

7.7 - External stop

- Select this input to stop the current step and skip to the next one.

The conditions can be as follows:

The input event is: «External stop to next step».

	on rising edge
	on falling edge
	on change (rising or falling)
	on high level
	on low level

7.8 - Result on external stop

- If the «External stop to next step» event condition is detected, the step report can be forced to OK/NOK or will depend on the Monitoring.

7.9 - Loosening

The loosening function allows un-tightening the joint according to torque or angle control.

- Select the type of control:
- Tap anywhere on the curve to display the screen of values.
- Fill in the values.

7.9.1 - Torque control and angle monitoring

Loosening with torque control and angle monitoring is used when you want to keep up a small constraint in the assembly.

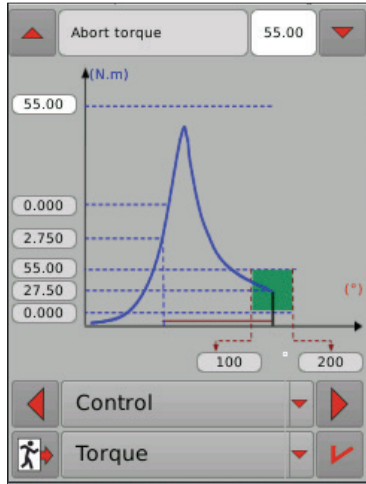

Parameters

Breakaway torque	starts the torque measure.
Loosening threshold	starts the angle measure.

Stop conditions

IF Torque > Abort torque
 OR
 IF Torque > Breakaway torque (after relaxation)
 OR
 IF Torque ≥ Target torque

Report OK	IF Min torque < Final torque < Max torque AND IF Min angle < Peak or Final Angle < Max angle.
-----------	---

For each channel, the 3 report controller LEDs will light according to the following diagram.

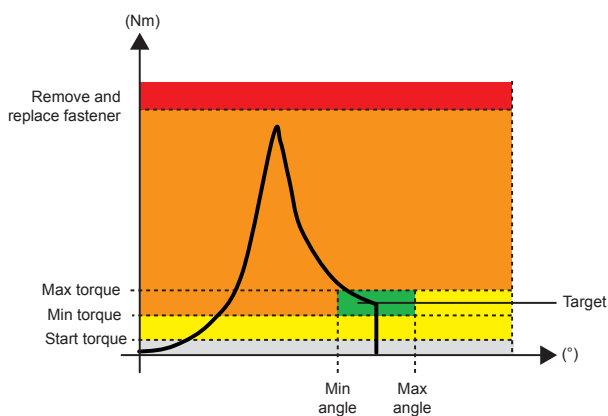

Result data	Final torque Peak OR Final angle
-------------	-------------------------------------

7.9.2 - Angle control and torque monitoring

Loosening with angle control is mainly used to release the constraints in the assembly. When this strategy is selected, the torque and the angle are monitored automatically.

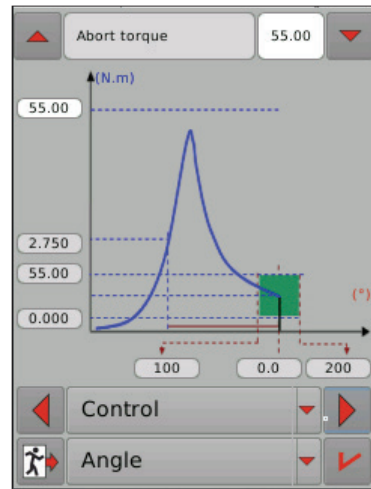

Parameters

Loosening threshold	Start the angle measure.
Target angle	Loosening angle expected.

Stop conditions

IF Torque > Abort torque
 OR
 IF Torque ≤ Target angle

Report OK	IF Min torque < Final torque < Max torque AND IF Min angle < Peak or Final angle < Max angle
-----------	--

For each channel, the 3 report controller LEDs will light according to the following diagram.

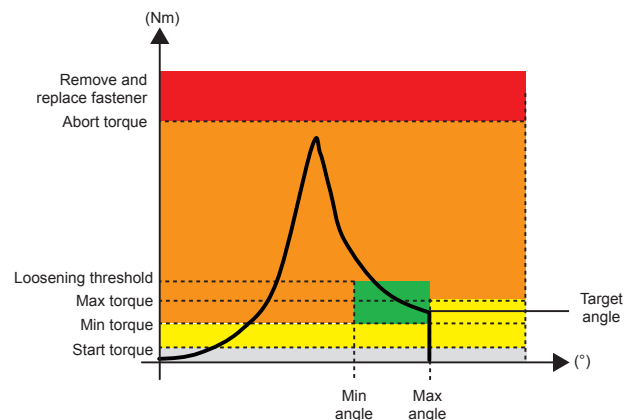

Result data	Final torque Peak OR Final angle
-------------	-------------------------------------

7.9.3 - Motor control - loosening

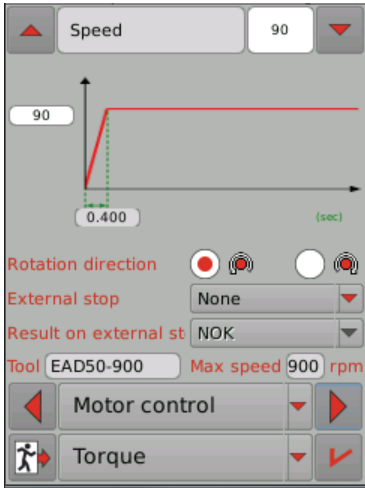

- Tap the screen and fill in the values.
 - speed
 - acceleration time

7.10 - Prevailing

The prevailing step allows you:

- to check the residual torque (prevailing torque) of a mechanical assembly (e.g. gearboxes, crankcases).
- to know if there is a mechanical «hard» spot in the assembly.
- to detect the absence of a component in the joint (e.g. crankshaft or connecting rod bearing shell, gear, control of the friction torque of a Nylstop nut), when the residual torque is lower than the min. torque.

- Tap «Strategy».



- Select the type of strategy:

7.10.1 - Forward prevailing

In a forward prevailing step, the start and stop can be controlled by angle.

This allows you to eliminate the “shock” when starting motor and mechanism.

- The torque is measured from start.
- The angle is measured from a prevailing threshold.
- The torque value is monitored from a start angle value up to an end angle value.
- The prevailing torque value must lie between min. and max. torque.

The stored results include the min. and max. torque values and the average value of the torque measurements during the acquisition phase. The system stops the acquisition of the torque and angle values when the motor stops. The torque pulse at the motor stop is not taken into account.

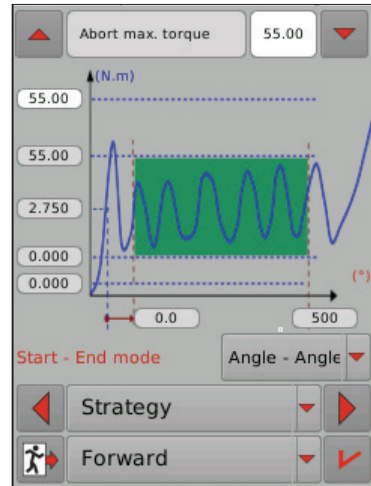

7.10.2 - Motor control - forward prevailing

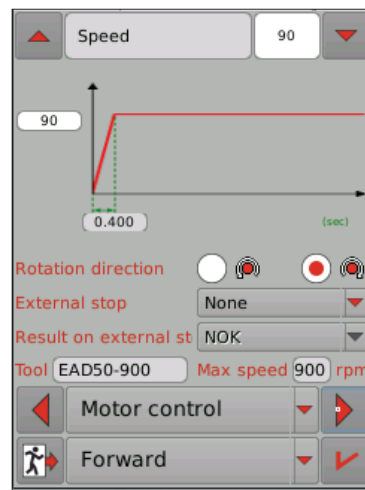

- Tap the screen and fill in the values.
 - speed
 - acceleration time
- Select the Rotation direction: Clockwise / Counterclockwise.



- Refer to chapter 7.7 for the settings of the options.

7.10.3 - Prevailing parameters

- Tap «Parameters».

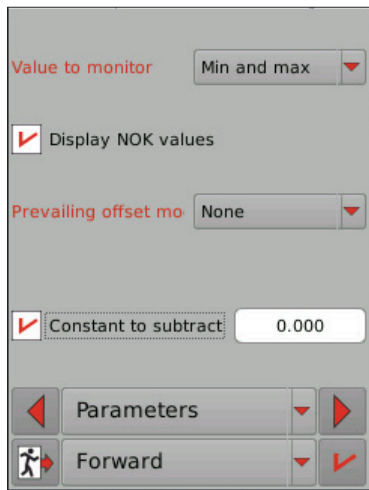

- Select the prevailing torque value to monitor:

average	The report is OK when the mean of all torque values during the measuring period is between "min torque" and "max torque".
min	The report is OK when the lower torque value during the measuring period is between "min torque" and "max torque".
max	The report is OK when the higher torque value during the measuring period is between "min torque" and "max torque".
min and max	The report is OK when all torque values during the measuring period are between "min torque" and "max torque". <ul style="list-style-type: none"> • Tick "Display NOK values" to store and display min. or max. torque measurement in case of NOK report.



By default, the prevailing torque average value is displayed and stored.

Option 1 - Prevailing offset mode

- Select the «Prevailing offset mode»: none/add/subtract. The average value of the prevailing torque is used as an offset to be added or subtracted from the torque transducer reading for the next steps of the Pset.



Step settings and values are not changed. The offset is applied to the torque transducer reading.

Prevailing and Tightening - Add offset (without constant)

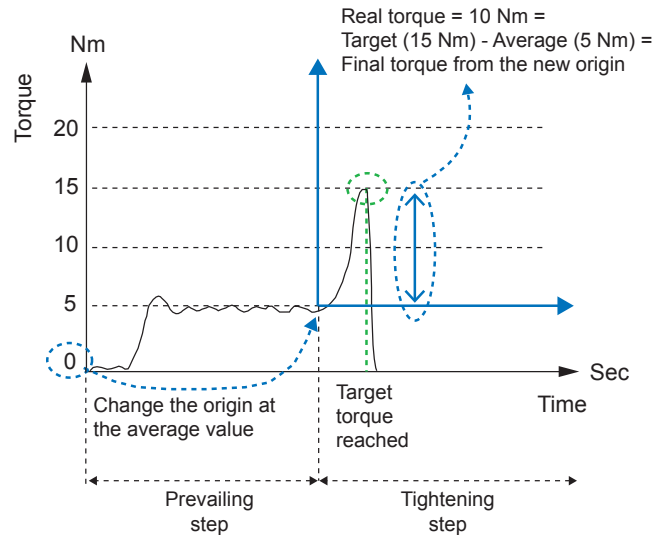

Prevailing and Tightening - Subtract offset (without constant)

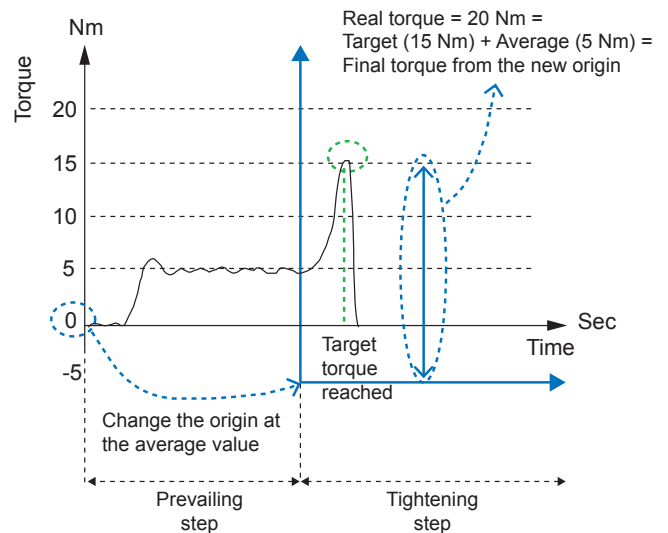

For the next steps of the Pset, it will be possible to reset the applied Prevailing torque offset by ticking "Offset reset" in the screen «7.4 - Monitoring & options».

Option 2 - Constant to «Subtract»

- Tick «Constant to subtract» and enter a torque value which will be subtracted from the torque transducer reading at the beginning of the Prevailing step.



For the next steps of the Pset, it will be possible to erase this constant offset from the torque transducer reading by ticking "Offset reset" in the screen «7.4 - Monitoring & options».

7.11 - Synchro step

The «Synchro» step is used to synchronise the steps of several tools driven by a common tightening unit (internal) or by different controllers (I/O).

- To sync several controllers, program Synchro steps for each controller and use the «Synchro in» and «Synchro out» I/O events to connect physically the controllers together (via 24 V I/O).



- Refer to "Appendix - Connections" to get more information.



- Tap this icon to edit the step.

- Enter a comment (up to 100 characters).
- Enter the max. wait time of the Synchro step. When this time is reached, the tools will stop and the report is NOK.
- Tick «Stop after max. wait time».
- Enter the synchro source:

internal	between the tools of a tightening unit.
internal + IO	between the tools of a tightening unit and with the other tools of other controllers (via the 24 V I/O).



- For further information, contact your Desoutter representative for support.

8 - ASSEMBLY PROCESS

Path: Main menu / Configuration / Assembly Process



An Assembly Process is commonly called AP and shown by this icon.

An Assembly Process is the set of one or several assembly actions to proceed in a defined order.

Each assembly action consists of a Pset to execute a certain number of times called «batch».

The Assembly Process describes the workflow to assemble parts and has 3 phases:

Start conditions	Assembly Process selection by I/O, Fieldbus, Open Protocol, etc...
Process	Sequence of tightenings which is using Psets as tightening recipes. Assembly actions can be executed in a forced sequential order or a free parallel order.
Post processing	Post-processing actions are to be executed when the AP is finished or aborted.



to delete an Assembly Process



to quit without saving

8.1 - How to create an Assembly Process



- Tap this icon to create an Assembly Process.

The AP number is automatically selected.

- Click the «Description» label to display the text keyboard.
- Enter a description (up to 40 characters).
- Select the source which will start the Assembly Process.

- Select the Pset number: new or already existing

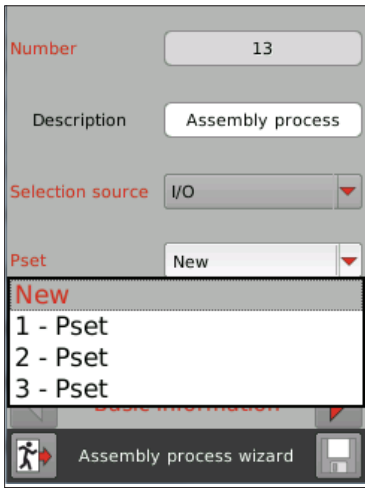

- Create the list of Psets as described previously in this manual.
- Enter the batch size: 1-99 or unlimited.

 • Tap this key to display the next screen.



- Enter a name (up to 40 characters).
- Enter the target torque. Click the label and write the text by using the digital keyboard.

 • Tap this key to display the next screen.

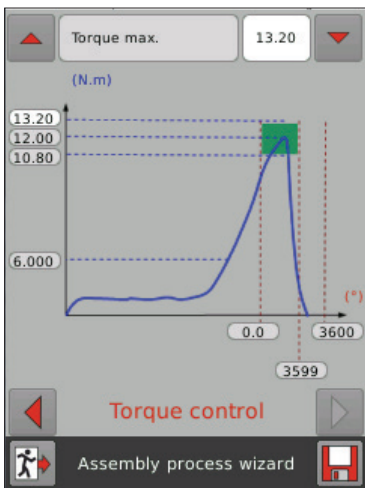

- Fill in the values.

8.2 - How to view the list of Assembly Processes

Path: Main menu / Configuration / Assembly Process



- Tap this icon to view the list of Assembly Processes.

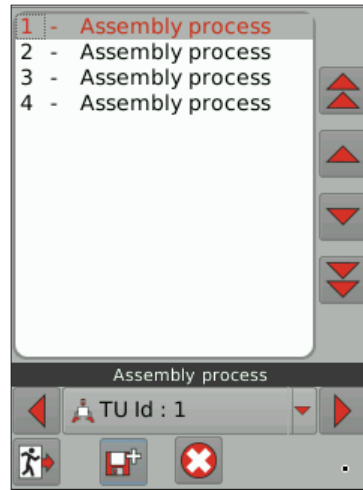

- Launch CVI CONFIG software to edit and change the Assembly Process settings.



- For more information, refer to the CVI CONFIG user manual at <http://resource-center.desouttertools.com>.

9 - MONITORING

9.1 - Main screen

When the controller is powered on, the following screen is displayed:

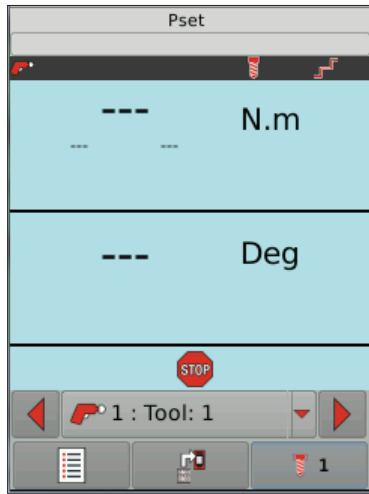

Pset	Pset name	from the last result
	Tool serial number	
	Pset ID	
	Number of the last step executed	
1	<p>The Running mode of the tightening unit is "Pset". Pset 1 is selected.</p> <ul style="list-style-type: none"> Start the operation. Tap the icon to select another Pset. 	
1	<p>The Running mode of the tightening unit is "Assembly Process". Assembly Process 1 is selected.</p> <ul style="list-style-type: none"> Tap the icon to select another AP. <p> The programming of Assembly processes is possible with CVI CONFIG only. The batch count is displayed on the top right of the screen.</p> <p> When data are transferred from CVI CONFIG, the controller must be in the Monitoring screen mode.</p>	
	<ul style="list-style-type: none"> Tap this icon to display the Monitoring view menu. 	
	<ul style="list-style-type: none"> Tap this icon to display the main menu. 	

After each operation, the report is displayed. It can be OK or NOK.

9.2 - Display change/Tool selection

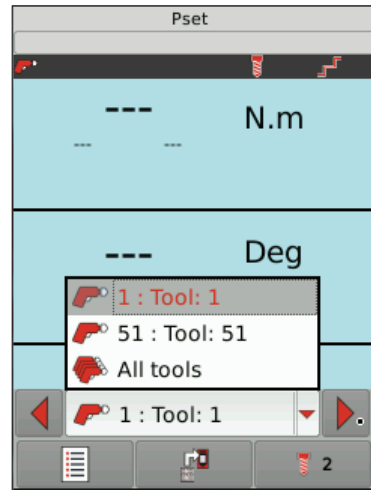

- Use these icons to change the display.
- Tool 1
- Tool 51
- All tools

9.3 - Report OK

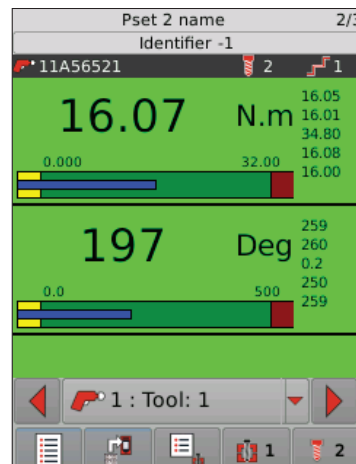

The report is OK: the operation is complete. Additionally to the main screen, the following information is displayed:

Batch status	The batch status is displayed only when an Assembly Process is selected. Example: 2/3
Tightening unit name or Identifier saved in position 1 of the result	
Tightening unit comment	

9.4 - Report NOK

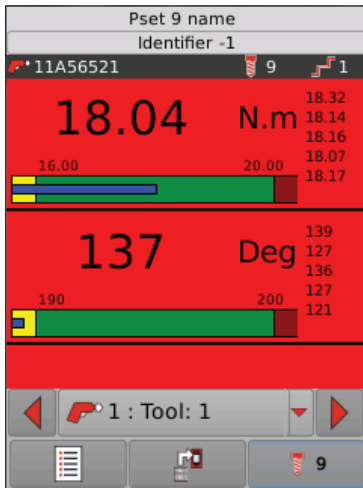

The report is NOK: the operation is not successful.
Some more icons may be displayed to explain why.

	Tool lock icon	The tool is locked
	Reverse icon	A run reverse has been performed.

When the report is NOK, you may need to modify the settings and return to the main menu.

	Main menu	• Tap this icon to access the configuration or maintenance menus.
--	-----------	---

9.5 - Monitoring view menu

Both OK and NOK screens can be displayed in different types of views:

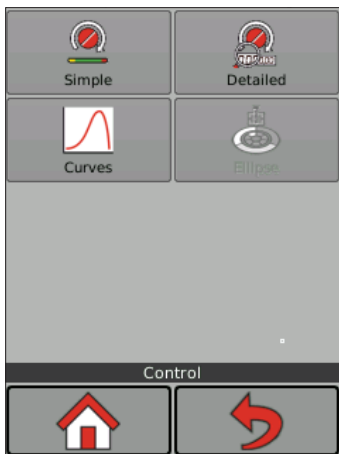

9.5.1 - Ellipse view (in Assembly Process running mode only)

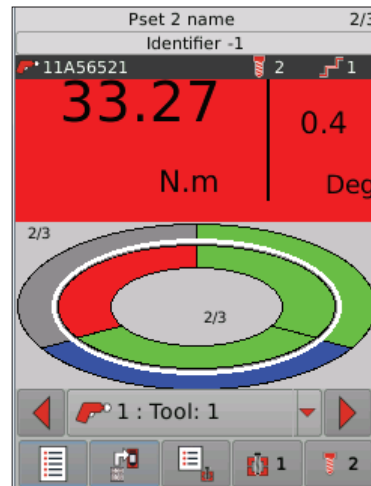

The diagram shows the different steps performed during the Assembly process operation.

The outer ellipse represents the whole Assembly Process divided in assembly actions. In this example, the part in green is complete and the report is OK, the assembly action in blue is running and the grey part will be the next step.

At the top right, the figure shows the actions status.

The inner ellipse represents the batches. A batch is the number of times that a Pset is executed. In this example, 2 tightenings out of 3 are completed.



- Tap this icon to display the list of actions which can be done on the assembly.

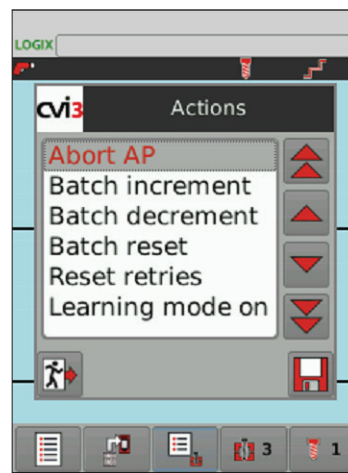

	Abort AP	to stop the complete Assembly Process
	Batch increment	to skip one bolt
	Batch decrement	to redo the last bolt
	Batch reset	to restart the complete batch
-	Reset retries	to reset the number of the "NOK tightening retries" counter of the running assembly action.
-	Learning mode on	to start the teaching mode. This action is displayed only when a positioning arm is connected to the eBUS cable.

The batch report will be OK or NOK according to the programming of the «batch count type» and «Forced batch status» features.



- Refer to CVI CONFIG user manual, chapter «11.5 - Assembly action».

9.5.2 - Simple view

- Tap «Simple» to display the screen:

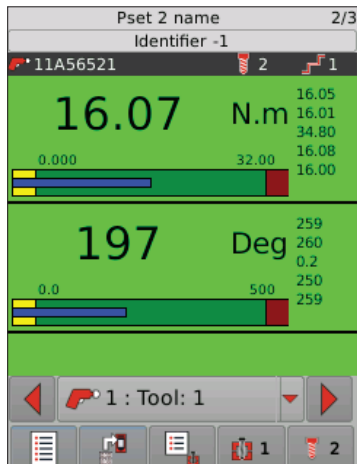

The following values are displayed:

- Min. and max. torque
- Min. and max. angle

yellow	low zone	Torque/angle below torque min/angle min.
green	zone OK	Torque/angle within acceptance window
blue	result	Measured values
red	high zone	Torque/angle above torque max/angle max.

The torque and angle values are displayed as well as the last 5 torque and angle values.

- Tap the screen to return to the monitoring view menu.

9.5.3 - Simple view - prevailing step

Last step - prevailing

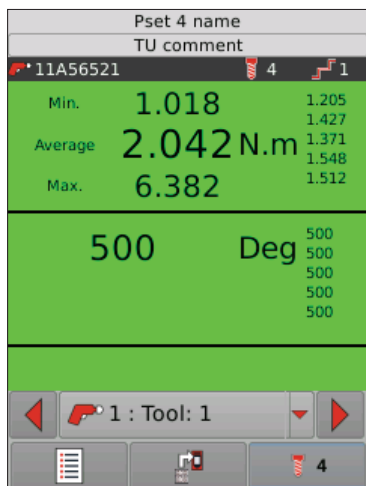

The following measurements are displayed:

- Min. prevailing torque
- Average prevailing torque
- Max. prevailing torque

Prevailing and tightening

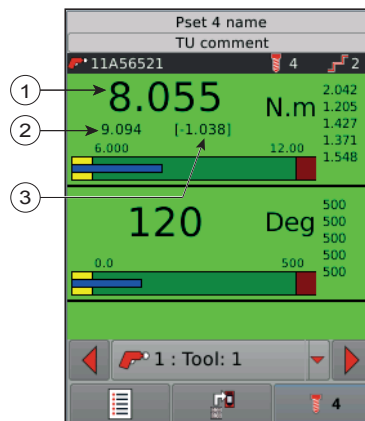

Legend

- Target torque
- Real torque
- Offset applied



- Refer to chapter to «7.10 - Prevailing» get more information about the prevailing step.

9.5.4 - Detailed view

- Tap «Detailed» to display the screen:

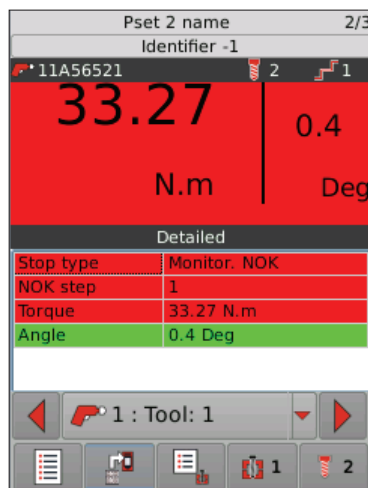

When the report is NOK, the following information is displayed:

- stop source
- NOK step number
- monitorings NOK

- Tap the screen to return to the monitoring view menu.

9.5.5 - Curve view

- Tap «Curve» to display the screen:



The curves available are:

- Torque vs Angle
 - Torque vs Time
 - Angle vs Time
 - Current vs Time
 - Speed vs Time
- Tick «Auto refresh» to keep refreshing the curve after each operation.

	• Use this icon to point to the first value on the left. Keep pressing the icon to follow the curve.
	• Use this icon to point to the first value on the right. Keep pressing the icon to follow the curve.

The markers show remarkable samples.

The white cross shows the current sample.

- Use the dot lines to navigate on the curve.
- Tap the screen to return to the monitoring view menu.

9.6 - «All tools» display

The following screens are available when more than one tool is connected to the controller.



Both tools results are displayed.

- Tap this icon to view other displays.

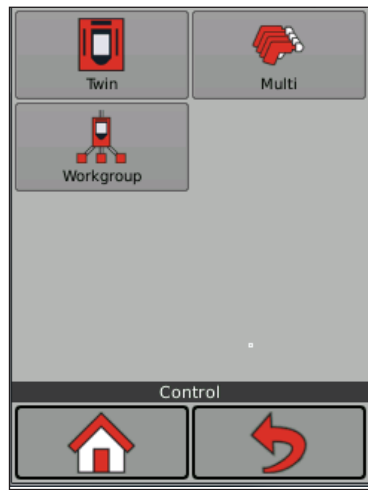

9.6.1 - Twin

This screen shows the results of both tools.



9.6.2 - Multi

This screen shows the list of results of all connected tools.

Tool id	Torque (N.n)	Angle (Deg)
✓ 11B58611	0.154	404
✓ 10A48860	0.181	404
✓ 11B58611	1.522	404
✓ 10A48860	0.208	404
✓ 11B58611	0.089	404
✓ 10A48860	0.194	404
✓ 11B58611	0.077	404

9.6.3 - Workgroup

This screen shows several tiles corresponding to each tool of the workgroup.



- Click any tile to display its detailed information.

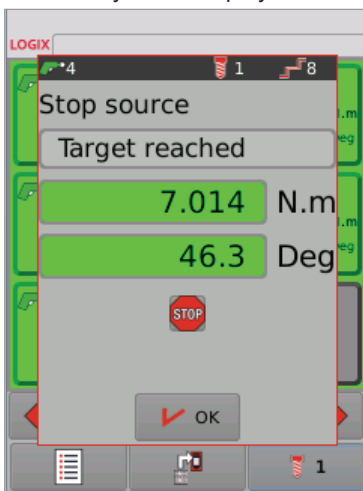

9.7 - Additional transducer

When an additional transducer is detected on the tool, the display of the results changes accordingly to the supervision mode set in «CVI CONFIG» software.

9.7.1 - Consistency mode

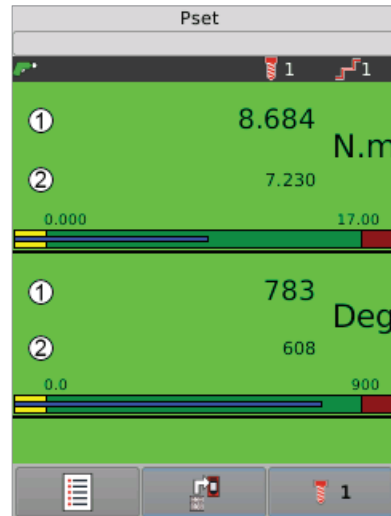

In this example, the global result is declared «OK». The drift between both transducers is within the tolerances set in «CVI CONFIG».

- ① Embedded transducer
- ② Additional transducer

i The torque and angle values of the control transducer are in bold type.

9.7.2 - Redundancy mode

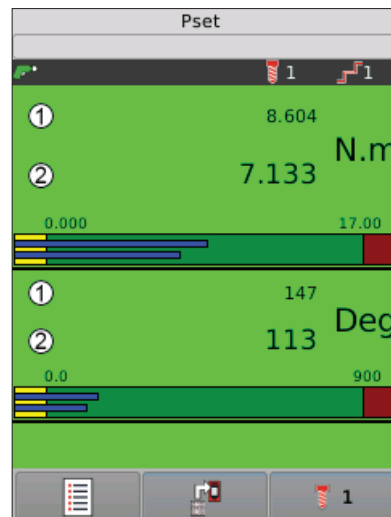

In this example, the global result is declared «OK». The drift between both transducers is within the tolerances set in «CVI CONFIG».

- ① Embedded transducer
- ② Additional transducer

i The torque and angle values of the monitoring transducer are in bold type.

9.8 - User information

When an event occurs, a message is displayed on the monitoring screen.

For example:



- Press the icon to display the resolution procedure.



- Refer to "Appendix - User info codes" to get more information.

- Tap the «Stop» icon on the top left to hide the user info.
- Tap the «Bar code» icon on the top right. The following screen appears:

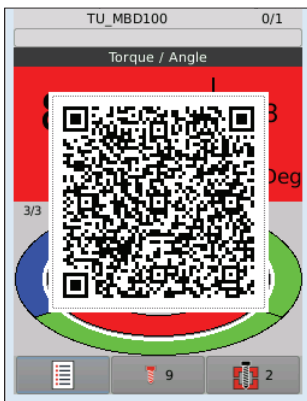

The QR code (Quick Response code) is displayed.

- To get support from Desoutter, use one of the applications in the table below to open the Web page and follow the instructions.

Mobile/OS	Application name
Iphone	ScanLife
Android	QuickMark
Blackberry	QR code scanner pro

10 - RESULTS

- Tap «Results» on the main menu.

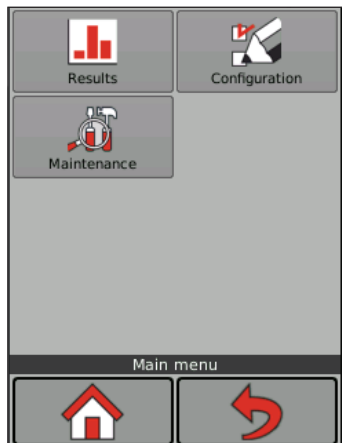

The following screen is displayed:



Up to 10,000 results can be saved.



- Select and tap one result, then tap this icon to display its details

- Use the arrow buttons to scroll through the list.

10.1 - Main screen description

	Report OK - The operation is complete
	Report NOK - The operation is not successful.
	Run reverse
	Batch increment
	Batch decrement
	Tool report OK

	Tool report NOK
1	Tool no. 1
2	Tool no. 2
1st column	Torque value
2nd column	Angle value

10.2 - Detailed view

- Use the arrow buttons to scroll through the list.



- Select and tap one result, then tap this icon to display its details

For example:

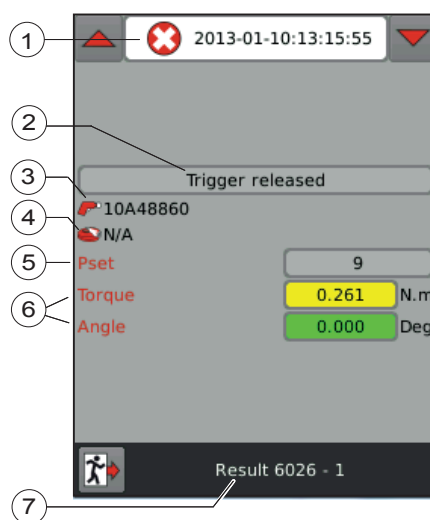

Legend

- 1 Report status and date/time
- 2 Stop source
- 3 Tool serial number
- 4 Cable serial number
- 5 Pset ID
- 6 Torque & angle values - Monitoring status
- 7 Result ID - Tool ID

10.3 - Filter

- Tick «Filter» to display this screen:

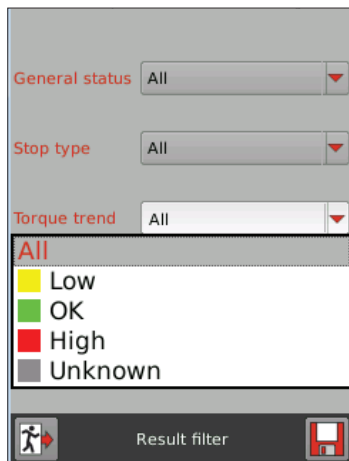

- Select the filters, tick «Filter enabled» and press the «Save» icon to save the selection.

Color	Trend
yellow	Low torque, low angle
green	Torque OK, angle OK
red	High torque, high angle
grey	Unknown

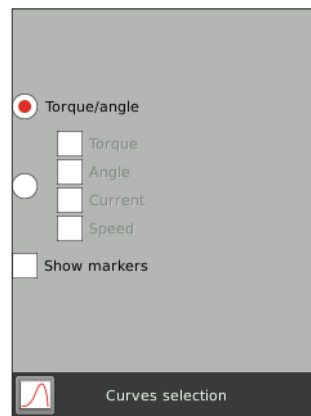



Ticking «Show markers» will allow you to better interpret the curve.



- Tap this icon to view the new curve display.

10.4 - Curve

	• Select a result and tap on this icon to display its curve. It may happen that there is no curve because the results are not representative.
	• Use this icon to zoom the first value.
	• Use this icon to zoom the last value.

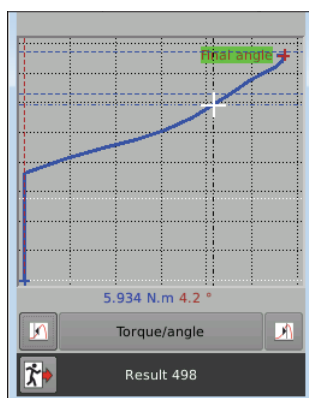

- Touch and slide from top left to bottom right to zoom in a particular area.
- Tap the middle of the screen to zoom out.
- Tap «Torque Current» field to select the display parameters

11 - MAINTENANCE

11.1 - Controller



11.1.1 - USB key - Firmware upgrade

Path: Main menu / Maintenance / Controller / USB

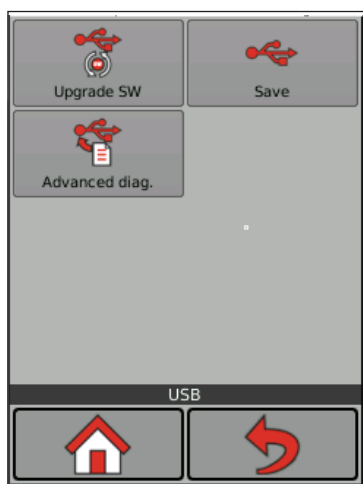

- Copy the ".cvi3" image to the root of your USB key.
- Check there is 1 ".cvi3" image only on your USB key.
- Copy the ".cvi3.md5" file to the root of your USB key.
- Check there is 1 ".cvi3.md5" file only with the same release number on your USB key.
- Plug the USB key to the front panel port.
- Tap "Upgrade SW".

The controller beeps during 2 seconds and starts the process.



- Do not switch off the controller.

- Wait for the automatic reboot. The update lasts a few minutes.

When the upgrade is successful, the green LED is on.

11.1.2 - USB key - Save

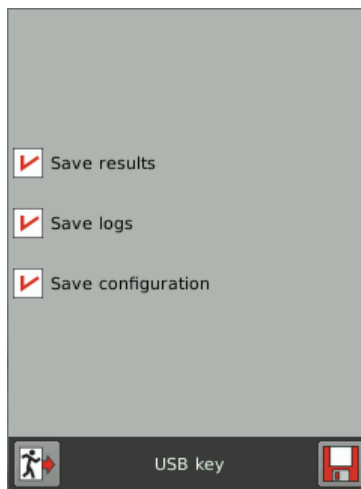

- Plug a USB key into the front panel port.
- Save your data: results / logs / configuration.

11.1.3 - USB key - Advanced diagnostic

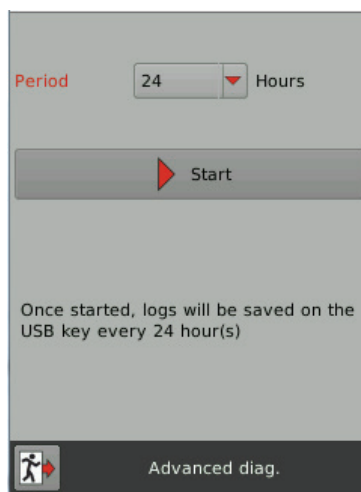

- Plug a USB key into the front panel port.
- Select how often the logs are saved on the USB key.

Period	1/2/6/12/24 hour(s)
--------	---------------------

- Click «Start».



- Do not unplug the USB key from the front panel.

11.1.4 - CVILOGIX

Path: Main menu / Maintenance / Controller

Pre-requisite:

- ePOD including the CVILOGIX function
- USB key including your own CVILOGIX program.
- Plug in the ePOD to the bottom panel.
- Plug in the USB key to the front panel.

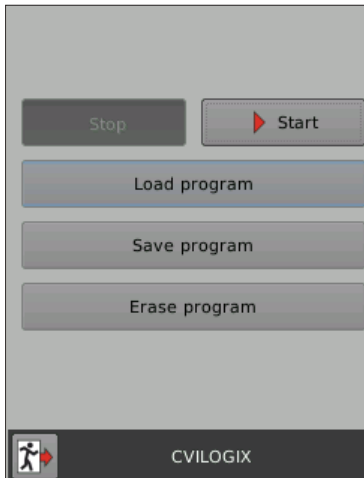

LOGIX The CVILOGIX logo is activated and displayed on the top left of the monitoring screen.

- Tap «Load program».
- Tap «Start» to launch the program.

LOGIX The CVILOGIX program is running and the logo turns green.

- Tap «Save program» to save the program on any USB stick connected to the controller front panel.

 • For further information, contact your Desoutter representative for support.

11.1.5 - Physical I/O configuration





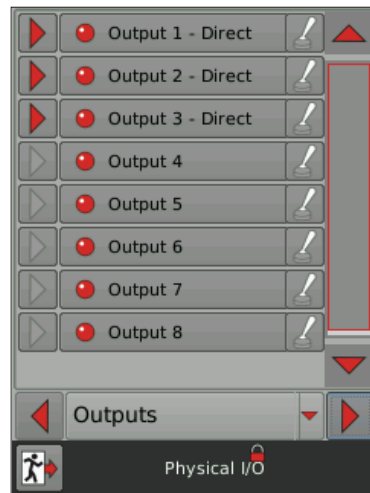
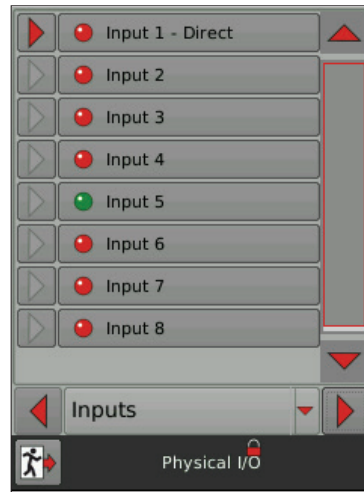

To activate these screens, you need to have a USB stick with the right profile (configured with the Desoutter CVIKEY software).

- If not, contact your CVIKEY manager for support.

Path: Main menu / Maintenance / Controller / IO



- For more information about how to assign events to physical I/O, refer to the CVI CONFIG user manual at <http://resource-center.desouttertools.com>.

	I/O ON
	I/O OFF
	I/O events are associated to physical I/O. • Click to display the assignment.
	I/O events are not associated to physical I/O.
	<p>To activate this function, you need to have a USB stick with the right profile (configured with the Desoutter CVIKEY software).</p> <ul style="list-style-type: none"> • If not, contact your CVIKEY manager for support. <p>• Click this icon to switch the signal.</p>

- Use the left, right or down arrow keys to navigate from one screen to another.
- Use the scroll bar to navigate in the screen.



When the application needs a larger number of I/O, it is possible to connect I/O expanders on the eBUS network.



- Refer to "Appendix - I/O and events" to get more information.

11.1.6 - Event I/O programming



To activate these screens, you need to have a USB stick with the right profile (configured with the Desoutter CVIKEY software).

- If not, contact your CVIKEY manager for support.

Path: *Main menu / Maintenance / Controller / IO*

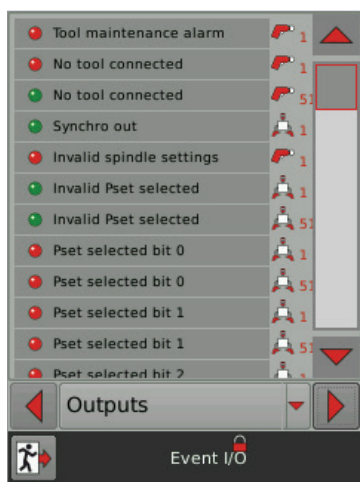

	I/O or event ON
	I/O or event OFF

The goal is to associate I/O events to the controller physical I/O. Some of the most frequently used events are already assigned.

I/O events can be classified as follows:

	I/O dedicated to a tightening unit.
	I/O dedicated to a tool.
	I/O dedicated to a controller

- Use the left, right or down arrow keys to navigate from one screen to another.
- Use the scroll bar to navigate in the screen.



- Refer to "Appendix - I/O and events" to get more information.

Force/unforce an input event

- Click the line of the Input event to force. The button turns green. This input event is now activating the corresponding controller physical Input.



Warning!

When you quit the screen, the forced signal becomes unforced.

11.1.7 - Ping

This function is used to check the network connection with any device connected on the network.

- Select the IP address to ping.

There are 4 attempts.

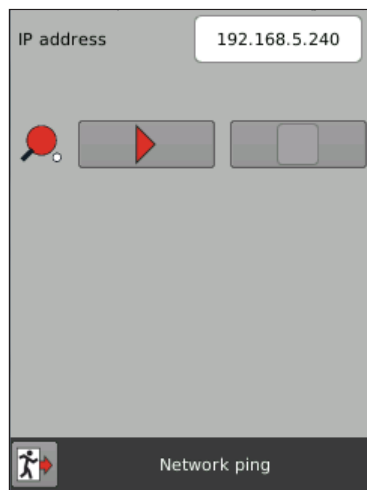

	• Click this icon to start the process.
	• Click this icon to stop the process.

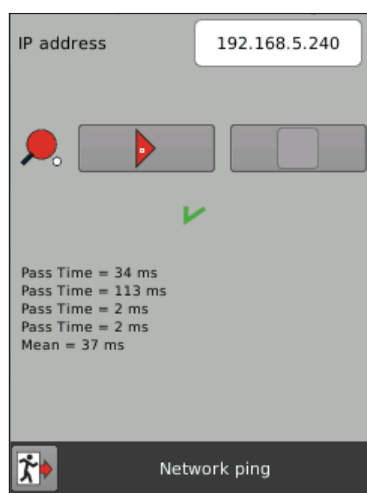

11.1.8 - Memory

Path: Main menu / Maintenance / Controller

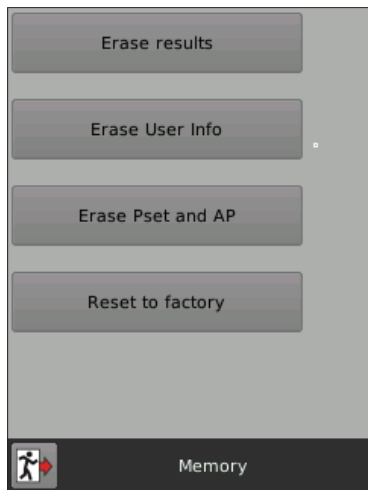

- Select and tap which type of information to erase from the controller memory:
 - results
 - user information
 - Psets and Assembly Processes configurations
- Tap «Reset to factory» to reset the memory of the controller. However, the logs and user information are preserved.

11.1.9 - Calibration of the controller screen

Path: Main menu / Maintenance / Controller

Calibration is necessary when the controller is powered on for the first time.



- Tap on «Yes» to display the calibration screen.
- Tap each of the 5 crosses.

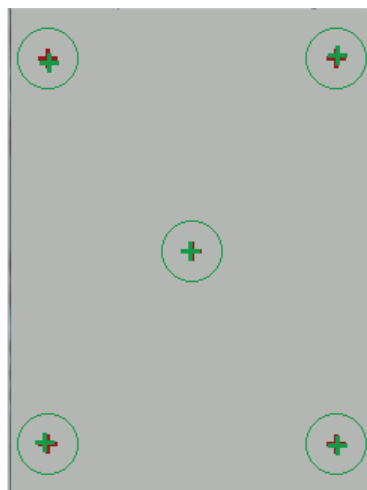

The controller will automatically re-calibrate the screen: the green crosses must be over the red ones as accurately as possible.

- Tap the screen.

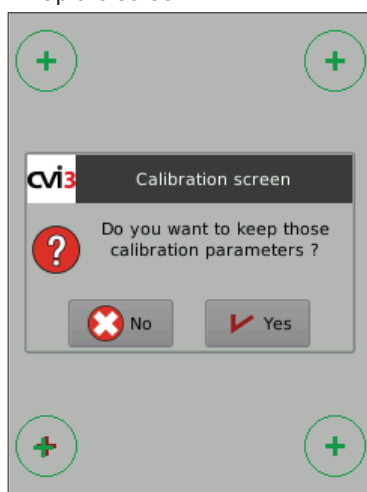

- Press «Yes» or «No» to save or not the new calibration parameters.



If no action is done within 10 seconds, the previous parameters are kept.

11.2 - Tool

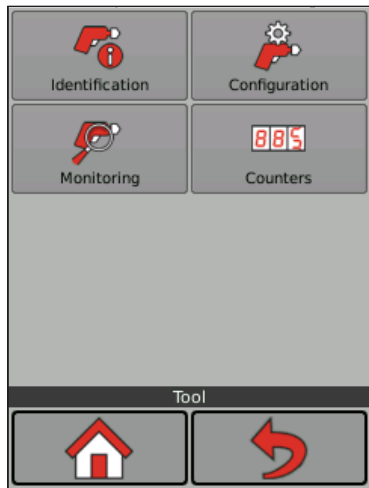

11.2.1 - Tool identification / characteristics

Path: Main menu / Maintenance / Tool

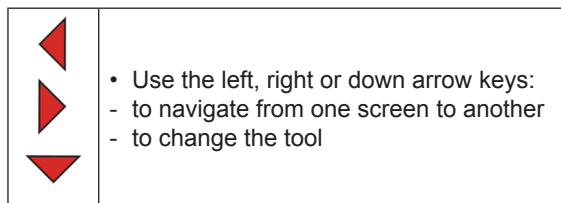

11.2.2 - Tool identification



- Enter a comment (100 characters).

11.2.3 - Tool characteristics (read-only)



The characteristics of the tools are:

- Tool family
- Motor type
- Tool type
- Gear ratio

11.2.4 - Tool configuration (read-only)

Path: Main menu / Maintenance / Tool

This screen shows the tool configuration (triggers, fixed accessories, etc...).



Available for Desoutter technicians only.

It is mandatory to calibrate the tools after they have been modified.

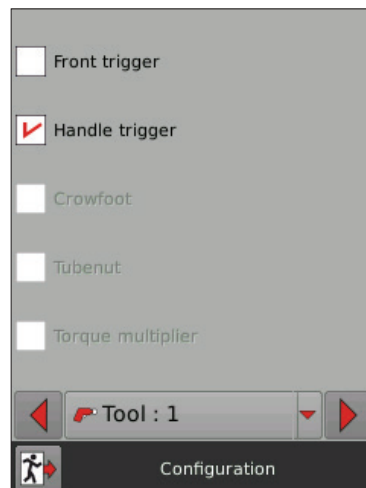

- Refer to the CVIMONITOR user manual at <http://resource-center.desouttertools.com>.

11.2.5 - Tool monitoring

Path: Main menu / Maintenance / Tool

- Use the left, right or down arrow keys to navigate from one screen to another.

11.2.6 - Transducer



Calibration data are given per transducer and per tool.

11.2.7 - Temperature



The following information are displayed:

- Motor temperature limit
- Temperature Alarm Release Limit

11.2.8 - Tool counters

Path: Main menu / Maintenance / Tool

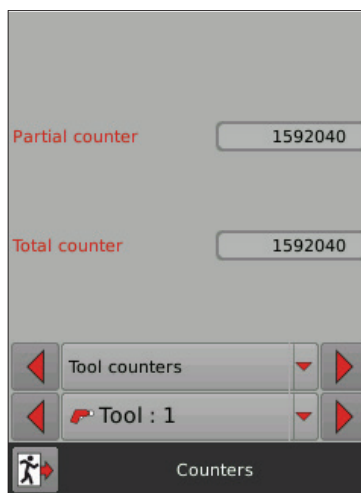

Total counter	Number of tightenings and run reverses above the tool min. torque since the manufacturing date.
Partial counter	Number of tightenings and run reverses since the last reset by using CVIMONITOR.

- Use the left, right or down arrow keys to navigate from one screen to another.

11.2.9 - Maintenance alarms



- Launch CVIMONITOR software to reset the partial counters and change the parameters.



Pop-ups are automatically displayed to alert the user to perform maintenance.



- Refer to "Appendix - Spare parts" to get more information.

11.3 - ePOD

Path: Main menu / Maintenance

- Plug in the ePOD to the controller.



- For more information about installing the ePOD, refer to the installation manual" part no. 6159931050 at <http://resource-center.desouttertools.com>.



11.3.1 - Backup/Restore

- Tap «Backup/Restore».

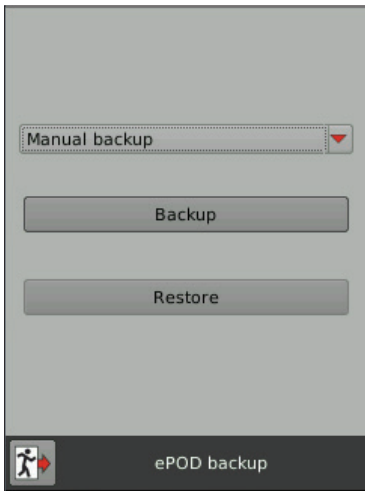

Manual backup	The ePOD is a snapshot of the controller.
Auto backup	Each modification is saved in real-time in the ePOD. The ePOD acts as the controller mirror.

- Press «Backup» to start the process.
- Press «Restore» to transfer the data from the ePOD to the controller.

11.3.2 - Eject



This command is mandatory to unplug the ePOD from the controller.



- Tap «Eject» before disconnecting the ePOD.

11.3.3 - Repair



- Tap «Repair» to start a recovery attempt of the data and results from the ePOD.

11.3.4 - Erase results

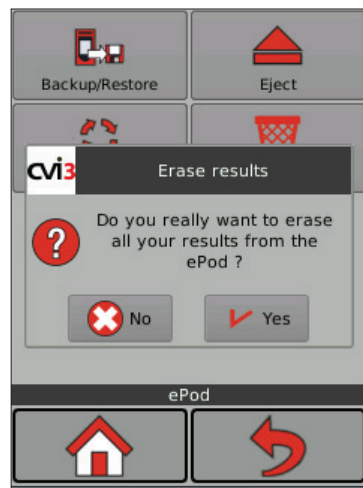

- Tap «Erase results» to erase all results stored in the ePOD.

11.4 - User information

Path: Main menu/Maintenance



- Use the Filter to classify the user info codes:
 - Info
 - Warning
 - Error



- Tap this icon to view the details of the event.



- Refer to "Appendix - User info codes" to get more information.

11.5 - Hardware and firmware versions

Path: Main menu/Maintenance/

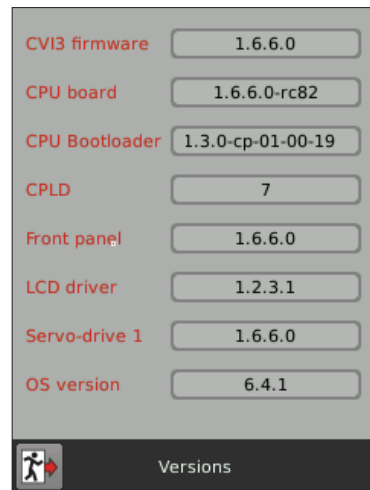

This information is useful to exchange information with Desoutter Servicing.



- Refer to chapter 11.1.1 to update the controller.

APPENDIX - I/O AND EVENTS

1 - LOGICAL OUTPUTS

Name	Description	Raising condition	Falling condition
General status			
Ready	The system is free of any internal issue that could prevent it from being fully operative. Communication between controller and tool is OK.	No error in controller nor in tool	- Quick stop activated - Error coming from the system
Identifier OK	Identifier received (e.g. barcode) matches masks (stays during 0.5 s at active level).	Identifier received and identified	0.5 s after rising
Identifier NOK	Identifier received (e.g. barcode) does not match masks (stays during 0.5 s at active level).	Identifier received but not identified	0.5 s after rising
User info present	User info (Info, Warning or Error) is present.	User info present on screen	No user info on screen
Keep alive ack	This output is the copy of the "Keep alive" input. It can be used by the PLC to check the controller is still running.	When "Keep alive" input raises.	When "Keep alive" input falls.
Fieldbus fault	No Fieldbus. The "Fieldbus fault" is on as long as the Fieldbus communication is not established. It switches off automatically when the communication works again.	Communication lost and/or keep alive missing.	Fieldbus communication established and keep alive present
Reporting Alarm	When working with ToolsNet or CVINet: FIFO Threshold Alarm reached. Results are stored in the controller memory and are erased when sent to ToolsNet or CVINet. This way the controller memory will never be full. A full controller memory induces result losses and traceability error. To detect communication issues with ToolsNet or CVINet, the software measures the fill in rate (%) of the memory. When the rate overpasses the target threshold, the Reporting alarm will switch on; maintenance operators are then able to solve the issue before losing results.	FIFO Threshold Alarm reached	FIFO under threshold alarm.
Open Protocol activated	Open Protocol is activated in configuration	Protocol is enabled	Protocol is disabled
Open Protocol connected	Open Protocol is connected to the Tightening Unit	At least 1 peer connected	No peer is connected
Time synchro done	Time synchronisation completed successfully using Fieldbus data (Q_SYN in VWXML)	-	-
Emergency stop	Emergency stop is activated	Emergency stop activated	Emergency stop deactivated
Tool status			
Tool ready	The tool is ready: - communication between controller and tool is ok - a valid Pset has to be selected - the tightening strategy must cope with the tool"	Tool connected AND valid Pset.	Tool disconnection, Pset selection.
Tool not locked forward	There is no tool lock in forward direction.	Tool unlocked in forward direction	New lock in forward direction
Tool not locked reverse	There is no tool lock in reverse direction.	Tool unlocked in reverse direction	New lock in reverse direction
Tool running	The tool is running (CW or CCW, tightening or loosening).	Tool starts to run.	Turns off when the tool stops.
Tool direction	Indicates if the tool is in tightening mode. Active: tightening mode Inactive: run reverse mode Note: independent if tool is running or not.	Entering tightening mode.	Entering run reverse mode.
Tool tightening	Tool is running in tightening mode. Pset threshold is not taken into account.	Tool start in tightening mode.	Tool stops.
Tool middle course trigger	Reflects the raw state of tool middle course start trigger, independently from Tightening Unit state.	Middle course of main trigger is reached	Main trigger is completely released.
Tool main start trigger	Reflects the raw state of tool main course start trigger, independently from the Tightening Unit state.	Trigger is pushed.	Trigger is released

Name	Description	Raising condition	Falling condition
Tool push start or front start trigger	Reflects the raw state of tool push start or front start trigger, independently from the Tightening Unit state.	Trigger is pushed.	Trigger is released
Manual reverse in progress	The operator has selected the reverse direction on the tool and is running the tool.	Manual runreverse selected and trigger pushed.	Stays on as long as the operator is running the tool
Fastener loosened	There is a fixed minimum torque value to declare that the fastener was "loosened".	Run reverse Result generation.	New start (tool trigger or external start)
Tube nut open	Indicates that the tube nut is open. The tool can be removed from the assembly.	-	Tool running
Tool maintenance alarm	Reflects the different tool maintenance alarm state with or condition.	Tool maintenance alarm 1 or 2 is active.	No tool maintenance alarm is active.
Invalid spindle settings	Tool characteristics does not match Pset parameters (e.g. negative jog times or contradictions, torque over the maximum tool torque range, speed over the maximum tool speed, maximum tool torque range, etc...)	Pset selection or tool connection.	Tool disconnection or new Pset selected.
Span failure	When starting a tightening, before running the tool, the controller checks the torque span. "Span failure" indicates that the span drifts by $\pm 3\%$ or more, causing a tool lockout. This fault can be due to the torque transducer or the tool electronics. The only solution is to replace the tool.	Span failure detection.	Disconnecting tool or new check without fault.
Offset failure	Indicates the offset (0 point) drifts by 50 % of full scale or more. This error exists when, at the beginning of the Pset, the torque transducer is seen to have 50 % or more of full-scale torque prior to even starting the motor. With an "Offset failure", the controller cannot adequately compensate for this transducer error and, therefore, will not allow a tightening operation to occur. The only solution is to replace the tool. Offset failures can come from a severely damaged torque transducer, a bad field cable or a bad controller.	Offset failure detection	Disconnecting tool or new check without fault.
Motor over temperature	Indicates that the temperature of the tool motor windings has exceeded the temperature threshold. An error message remains.	Temperature threshold: - 100°C for fixed tools - 60°C for portable tools	The signal turns off as soon as the temperature returns below the threshold (minus hysteresis = 10°C).
Angle measurement fault	Drive detected angle sensor fault. It can be an angle sensor fault, a tool electronic fault or a combination of both. The communication is tested permanently. As soon as the fault disappears, the signal turns off.	Angle fault detection.	Disconnecting tool
Angle measurement fault	Drive detected angle sensor fault. It can be an angle sensor fault, a tool electronic fault or a combination of both. The communication is tested permanently. As soon as the fault disappears, the signal turns off.	Angle fault detection.	Disconnecting tool
No tool connected	Indicates that the controller is not detecting the tool. Controllers are designed to work with a range of fastening tools. The tools have an Intelligent Tool Interface (ITI) board which is continuously sending status information to the controller. If the controller requests status information from the tool and gets no response, the controller software turns on the "No tool connected" output. This output resets immediately upon successful communication with a tool.	No tool connected or tool not recognized	Tool connected and recognized.
Redundancy error	Redundancy error in case of operational control transducer and faulty monitoring transducer.	Result generation	Use of "reset of redundancy error" input, change of tool free of this error

Name	Description	Raising condition	Falling condition
Pset status			
Pset selected bits (0..7)	Echoes the binary "Pset select bit 0 to 7" input if the corresponding Pset exists, echoes 0 if the Pset does not exist or there is no Pset selected.	New Pset selected	New Pset selected
Tightening running (old cycle declared)	This indicates that the fastening operation has actually started: the tool is running and the torque is over the Pset start torque threshold. The signal switches off as soon as the fastening operation is finished (all reports sent).	Torque reach the cycle start threshold.	The fastening operation is finished (all reports sent)
Tightening finished	Indicates that a Pset report is available.	Result generation.	New start (tool trigger or external start) or reset input
Tightening OK	Indicates that the fastening operation (for a specific Tightening Unit) ends correctly and that all controlled and monitored tightening parameters are within tolerances.	Result generation.	New start (tool trigger or external start) or reset input
Tightening NOK	Indicates that the fastening operation (for a specific Tightening Unit) has failed.	Result generation.	New start (tool trigger or external start) or reset input
Spindle OK	Indicates that the fastening operation (for a specific tool) ends correctly and that all controlled and monitored tightening parameters are within tolerances.	Result generation.	New start (tool trigger or external start) or reset input
Spindle NOK	Indicates that the fastening operation (for a specific tool) has failed.	Result generation.	New start (tool trigger or external start) or reset input
Angle low	Indicates a low angle reject. The angle must meet or exceed this value for a correct Pset. When the angle stays below this value, it becomes a "Low angle reject" and this output is turned on. Stays on until a new fastening operation starts.	Result generation.	New start (tool trigger or external start) or reset input
Angle OK	Indicates a correct angle. The angle is inside the limits declared in the step.	Result generation.	New start (tool trigger or external start) or reset input
Angle high	Indicates a high angle reject. The angle must stay below this value to be a correct Pset. When the angle meets or exceeds this value, it becomes a "High angle reject". The tool will stop when this limit is reached and this output is turned on. Stays on until a new fastening operation starts.	Result generation.	New start (tool trigger or external start) or reset input
Torque low	Indicates the peak torque low reject. If the torque stays below the "Peak torque low limit" and results in a "Reject" Pset. This can happen when a Pset is prematurely finished, a thread strips out or when the Pset is automatically finished due to other error conditions, such as a High angle fault or when a Pset Time Monitor expires and causes the Pset to be terminated. Stays on until a new fastening operation starts.	Result generation.	New start (tool trigger or external start) or reset input
Torque OK	Indicates a correct torque. Torque is in inside the limits declared in the step.	Result generation.	New start (tool trigger or external start) or reset input
Torque high	Indicates the peak torque high reject. When the torque meets or exceeds this value, this output is turned on and the results is NOK. If a Peak Torque High error persists, it may be advisable to slow down the tool speed or replace the tool with one of lesser capacity. A second variable that can cause Peak Torque High errors is a badly chattering joint. Chatter is the squawking noise you hear on some fasteners at the end of the fastening operation. Chatter is induced by slip-stick and actually causes the fastener to momentarily stop rotating, then crack loose and re-start turning. This condition can cause a Peak Torque High condition. A potential solution for this is to view Psets, General Tab, and set the frequency response slide bar to Better Noise Immunity, Chattering Joint). This causes the software to average many torque readings together to minimize the possibility of using a single high frequency torque value that could trigger a peak torque high fault. Stays on as long as a new fastening operation starts.	Result generation.	New start (tool trigger or external start) or reset input

Name	Description	Raising condition	Falling condition
Yellow report on tightening controller	This output reflects the state of the controller yellow light.	Controller yellow light is on	New fastening operation starts
Green report on tightening controller	This output reflects the state of the controller green light.	Controller green light is on	New fastening operation starts
Red report on tightening controller	This output reflects the state of the controller red light.	Controller red light is on	New fastening operation starts
Lock on reject	Indicates that a tool is locked out because of an incorrect tightening operation. The controller will not continue to run the tool depending on "lock on reject option": - until the "Error Acknowledge" input is activated. - until a run reverse operation - until a loosening operation"	Tightening finished with bad result and option "Lock on reject" activated.	Input "Error acknowledge" activated or runreverse operation or loosening operation
Remove fastener	Indicates that the fastening operation resulted in a torque that exceeded the "Remove Fastener" setpoint. When correctly set, this means that the torque for any reason becomes very high. There is a risk that the fastening operation is not reliable: disassemble the joint and check parts.	Result generation.	New start (tool trigger or external start) or reset input
Tightening finished without timeout	Indicates that a Pset report is available and the source stop is not overall timeout.	Result generation.	New start (tool trigger or external start) or reset input
Overall time reached	Max overall time has been reached during tightening	Result generation.	New start (tool trigger or external start) or reset input
Synchro out	Synchro output: set to 1 when running step starts, reset to 0 when a synchro step is reached.	Start of running step.	Synchro step reached
Invalid parameter set selected	Indicates the Pset is disabled (has not been set). For example, if 3 Psets are used, Psets 1, 2 and 3 are enabled. If, however, any Pset other than 1, 2 or 3 is selected, the Pset is invalid and this output is turned on. It is possible for an Assembly Process to select invalid Psets.	Pset unselection	Pset selection
Assembly Process status			
Assembly Process selected bits (0..7)	Indicates the Assembly Operation per Tightening Unit currently selected (Bit 0..7)	New AP selected. AP aborted	New AP selected. AP aborted
Assembly Process running	Indicates the assembly operation is being processed. The signal is on as long as the assembly operation is running. The signal falls down when the assembly operation is finished.	Assembly Process start.	Assembly Process finished or aborted.
Assembly Process finished	Indicates when an assembly operation is completed.	Assembly Process finished.	A new Assembly Process start or reset input
Assembly Process OK	Indicates when an assembly operation is completed with no rejects. The signal stays on as long as a new Assembly Process starts.	Assembly Process finished and OK.	A new Assembly Process start or reset input
Assembly Process NOK	Indicates when an Assembly Process reject occurs. Stays on as long as a new Assembly Process starts.	Assembly Process finished and NOK or aborted.	A new Assembly Process start or reset input
Assembly Process aborted	When an Assembly Process has been aborted, "Assembly Process aborted" is activated. Stays on as long as a new Assembly Process starts.	Assembly Process aborted.	A new Assembly Process start or reset input
Current batch count bit (0..6)	Bit indicator of current batch count	Batch count increment	when batch is finished, new start (tool trigger or external start) or reset input or new AP selection
Remaining batch count bit (0-6)	Bit indicator of the number of remaining bolts in the batch	Batch count increment	When batch is finished, new start (tool trigger or external start) or reset input or new AP selection

Name	Description	Raising condition	Falling condition
Batch running	A batch process is underway. The output is set to 1 before the first tightening operation.	A batch operation is enabled	Batch is finished or reset input
Batch finished	Indicates when the batch count equals the batch size and the batch is declared completed. It is used together with "Batch OK" to indicate the status of a batch.	Batch is finished.	New start (tool trigger or external start) or reset input
Batch OK	Indicates the status of the batch together with the "Batch finished" output (managed by Assembly Process).	Batch is finished and OK.	New start (tool trigger or external start) or reset input
Batch NOK	Such as when the batch gets aborted...or in the case rejects are included as part of the batch count (managed by Assembly Process).	Batch is finished and NOK. A new AP has been selected.	New start (tool trigger or external start) or reset input
External outputs AP			
External Out AP bit	Outputs that can be set or reset within an Assembly Process	Depending of AP behavior	Depending of AP behavior
External outputs PLC			
External Out PLC bit (0..9)	Indicates this output is controlled by a PLC via Fieldbus (like a remote I/O). On PLC side, it is an output.	Depending on PLC behavior	Depending on PLC behavior
External outputs OP			
External Out OP bit (0..9)	Outputs dedicated to Open Protocol.	Depending on OP behavior	Depending on OP behavior
Socket tray			
Socket selectable (0..4)	24 V socket trays (BSD). Informs which socket can be taken by the operator.	A new socket has to be taken by the user.	No socket to be taken by the user.
Customized protocol Status			
Customer protocol activated	A customer protocol has been activated in configuration	Protocol is enabled	Protocol is disabled
Customer protocol connected	The activated customer protocol is connected	Protocol is connected	Protocol is disconnected
Customer protocol reporting alarm	The activated customer protocol has declared an alarm about result reporting of this Tightening Unit.	Alarm is raised	Alarm is cleared
Q_SAS	ACK start tightening job	-	-
RDY	Controller ready	-	-
Q_LSN	Reverse disabled	-	-
WGZ	Tool disabled	-	-
Q_EDZ	Result and reports reset	-	-
Q_XMS	XML data transfer completed	-	-
EIO	Result OK	-	-
ENO	Result NOK	-	-
FSCIO	Group status OK	-	-
FSCNIO	Group status NOK	-	-
CVILOGIX			
External Out CVILogix bit (0..100)	Indicates that this output can be used by an internal CVILOGIX application.	-	-
Miscellaneous			
ON	On state, used to set level "1" to physical outputs.	At controller startup.	Never falls
OFF	Off state, used to set level "0" to physical outputs.	At controller startup.	Never falls

2 - LOGICAL INPUTS

Name	Description	Status
General commands		
Start stop Tightening on state	Initiates a fastening cycle if: - the "Spindle validation forward" is active and required by the Tightening Unit, - a Pset is selected. A rising edge must be detected to initiate a tightening, that is the change in the state of the tool from off to on as the trigger is released, then pressed again must be detected. For the tightening to proceed, this input must remain active. If this input becomes inactive at any time during the tightening, the tightening will be aborted and the tool will stop running. At the end of tightening, a tightening can began only if signal falls and then rise. After power-up, even if this signal is active, an edge is necessary to start tightening."	State
Toggle start stop tightening on edge	This input is enabled for fixed tools only (tools without trigger). Initiates or ends a fastening cycle. A cycle can be initiated only if: - the "Spindle validation forward" is active and required by the Tightening Unit - the Pset is selected If no tightening is currently executed, a rising edge will initiate a tightening. A falling edge has no effect on the tightening to proceed. If a tightening is in execution, a rising edge will stop it.	Rising edge
Reverse direction	When activated, the tool green & red lights are flashing to indicate that the Tightening Unit reverse direction is selected. This signal status is not controlled during a tightening but only when tool is not running.	State
Error acknowledge	Enables the "Reject lockout" function. When locked out, the tool cannot run until this input is reset.	Rising edge
Reset	When input reset raises (and there is no cycle running): - defaults are acknowledged - batch counter of current Assembly Process is reset - reports lights on controller and tool are set off - result on display is erased but the last 5 result values on Vision display stay readable - in Pset mode, Pset selected remains unchanged. In AP mode, AP is aborted. - ready output stay on - echo identifier is reset When input reset raises (and there is cycle running): - tightening is immediately stopped - defaults are acknowledged - batch counter of current Assembly Process is reset - at tightening end, there is no report generated. - at tightening end, it is impossible to start a new tight, reset input must be released first. - in Pset mode, Pset selected remains unchanged. In AP mode, AP is aborted. - ready output stay on - echo identifier is reset	State
Reset only status	When the input "Reset" raises during the Pset running: - tightening is immediately stopped Resets only: - Tightening OK/NOK/finished - Tool OK/NOK - Batch OK/NOK/Finished The Assembly Process is not aborted. Result values (angle, torque) are still present in Fieldbus. LEDs on tool and controller are not affected.	State
Ack error message	Acknowledge error message displayed on HMI.	Rising edge
Force Pset mode	Forces the Tightening Unit to switch in Pset mode in order to temporary run Psets (nothing saved). When AP mode + input state high, then switch to Pset mode. When Temporary Pset mode + input state low, then switch to AP mode. Switching on the controller power with the input set will switch to Pset mode. Other cases do nothing.	State
Ack result	Acknowledges the current result. The tool is then unlocked and can tight again. Formerly dedicated to Fieldbus only, this behaviour is now also available for IOs and Open Protocol.	Rising edge
Keep alive	Input used to check that the controller is still alive. State of this input is copied to "Keep alive ack" output. This input is also used by a PLC to inform the controller that Fieldbus communication is working.	State
Time Synchro Trigger	Execute date & time synchronisation from Fieldbus (SYN in VWXML protocol)	Rising edge

Name	Description	Status
Enable access manager	Enable/disable access manager	State
Lock display	Lock/unlock the controller display.	State
Restart Controller	Reboots the controller. Everything must be done by the software before using this input	Rising edge
Tools commands		
Tool validation forward	Enables the tool to run the selected Pset. Note: the forward and reverse validation can be done by setting both validations on the same input. When the validation signal falls down, the tool stops.	State
Tool validation reverse	Enables the tool run reverse. Note: the forward and reverse validation can be done by setting both validations on the same input. When the validation signal falls down, the tool stops.	State
Reset tool locks	Reset tool locks, only the none safety tool locks will be affected	Rising edge
Tool stop	Stops the tool.	Rising edge
Tool blue light ctrl by IO	1 = Tool blue light is controlled by IO 0 = Tool blue light is managed by the controller	State
Tool blue light	If "Tool blue light ctrl by IO" is set to 1 (see upward) then: 1 = tool blue light is set to on 0 = tool blue light is set to off	State
Tool green light ctrl by IO	1 = Tool green light is controlled by IO 0 = Tool green light is managed by the controller	State
Tool green light	If "Tool green light ctrl by IO" is set to 1 (see upward) then: 1 = tool green light is set to on 0 = tool green light is set to off	State
Tool red light ctrl by IO	1 = Tool red light is controlled by IO 0 = Tool red light is managed by the controller	State
Tool red light	If "Tool red light ctrl by IO" is set to 1 (see upward) then: 1 = tool red light is set to on 0 = tool red light is set to off	State
Tool yellow light ctrl by IO	1 = Tool yellow light is controlled by IO 0 = Tool yellow light is managed by the controller	State
Tool yellow light	If "Tool yellow light ctrl by IO" is set to 1 (see upward) then: 1 = tool yellow light is set to on 0 = tool yellow light is set to off	State
Tool white light ctrl by IO	1 = Tool white light is controlled by IO 0 = Tool white light is managed by the controller	State
Tool white light	If "Tool white light ctrl by IO" is set to 1 (see upward) then: 1 = tool white light is set to on 0 = tool white light is set to off	State
Reset of redundancy error	Resets redundancy error only.	State
Pset commands		
Pset select bit (0..7)	Used to select Psets. These inputs must be in the desired state BEFORE the activation of the cycle start input. If the selected Pset is zero, there is no Pset selected.	State
Select previous Pset	Select lower number Pset.	Rising edge
Select next Pset	Select higher number Pset.	Rising edge
External stop abort Pset	This input is used with proximity detectors to end immediately Pset running. The user can choose which state or transition will stop the Pset: No, Rising, Falling, Change, High, Low. When a Pset is aborted with this input, the Pset result is NOK.	Rising edge or state
External stop to next step	This input is used with proximity detectors to end the running step. The user can choose which state or transition will stop the Pset : No, Rising, Falling, Change, High, Low. The user can also choose the step result when the stop request occurs: OK, NOK, Monitoring (Monitoring means that the result is computed depending on monitoring requested).	Rising edge or state
Synchro in	Step synchronisation input. The step starts when a transition to 0 is detected.	State

Name	Description	Status
Assembly Process commands		
Assembly Process selection bit (0-7)	Used to select an Assembly Process. These inputs must be in the desired state BEFORE the activation of the assembly process start input.	Rising edge
Abort assembly process (tightening unit)	The "Abort assembly process" input stops the Assembly Process being processed. The Assembly Process is finished. The Assembly Process result is memorized as "aborted" and "AP aborted" and "AP NOK" events are set.	Rising edge
Batch-1	The "Batch-1" input allows the operator to select the previous operation of a batch whatever the result of the next operation. The batch counter is decremented. The action is recorded OK or NOK according to the result and "Batch-1 event" is set.	Rising edge
Batch+1	In case you cannot complete the current operation of a batch, jump to the next one by using the external input "Batch+1". The action is declared as NOK and "Batch+1" event is set.	Rising edge
Restart batch	Restarts the current batch of the current Assembly Process step. The "Restart batch" event is set.	Rising edge
Reset number of retries	Reset the number of retries counter. If the max counter has been reached, the tool is unlocked.	Rising edge
External inputs AP		
External in AP bit (0..9)	Inputs used in Assembly Process in start conditions or in assembly actions sense input	Rising edge
External inputs PLC		
External In PLC bit (0..9)	Indicates this input can be used by an PLC via Fieldbus (like a remote I/O). For PLC side, it is an input.	State
External inputs OP		
External In Open Protocol 1-8	Inputs used in Open Protocol. They can be monitored from the Open Protocol client by subscription. These Digin are named "External monitored 1..8" in Open Protocol specification.	State
Socket tray		
Socket lifted bit (0..4)	Used with CVI II controllers only: 24V socket trays (BSD). Informs which socket has been lifted.	State
Customized protocol commands		
PFCS END OF CYCLE	Input used in PFCS Chrysler to flush the result FIFO when the operator has completed the work	Rising edge
SAS	Starts tightening job	State
RST	Resets any running tightening job	State
LSN	Disables reverse	State
TOL	Tool validation	State
STR	Tool start	State
EDZ	Resets results	State
XMS	Synchronous XML	State
XMA	XML activated	State
CVILOGIX		
External In CVIlogix bit (0..100)	Indicates that this input can be used by an internal CVILOGIX application	State

APPENDIX - USER INFO CODES

Code no.	Description	Resolution procedure
2	Tool connected	1- The tool is connected and correctly recognized by the controller.
3	No tool connected	1- Tool has been disconnected. 2- If the tool is not physically disconnected, check the tool cable.
4	Span failure	1- Span value from torque sensor is outside bounds. 2 -Try once again to start the tool with no mechanical constraints. If the problem occurs again, contact your Desoutter representative for support
5	Offset failure	1- Offset value from torque sensor is outside bounds. 2- Try once again to start the tool with no mechanical constraints. If the problem occurs again, contact your Desoutter representative for support.
6	Tool motor rotor locked	1-Unable to start tool motor (rotor is locked), change your tool 2-Contact your Desoutter representative for support
7	Tool motor too hot	1- Tool is locked because its maximum motor temperature has been reached. 2- Tool will remain locked until the motor temperature comes back to its normal value.
8	Tool angle fault	1- Problem detected with the tool angle sensor 2- The tool needs maintenance. 3- Contact your Desoutter representative for support
9	Tool invalid parameters	1- Please check the tool compatibility. 2- The tool memory cannot be read or is invalid. 3- The tool needs maintenance. If the problem occurs again, contact your Desoutter representative for support.
10	Tool calibration alarm date expired	1- The tool calibration date has expired. 2- A tool calibration procedure needs to be done to ensure the measurement accuracy.
12	Tool EEPROM could not be read	1- The tool memory cannot be read or is invalid. 2- The tool needs maintenance. If the problem occurs again, contact your Desoutter representative for support.
13	Tool motor bad ground connection	1- Phase-phase or phase to ground shortcircuit. 2- Disconnect the tool. Contact your Desoutter representative for support.
14	Tool torque power default	1- The torque sensor is not correctly supplied 2- The tool needs maintenance. If the problem occurs again, contact your Desoutter representative for support.
15	Tool locked on reject	1- The tool is locked forward after a NOK. 2- Unlock the tool in function of the "lock on reject option" selection i.e. by reversing, loosening or input.
16	Tool locked by Open Protocol	1- Tool has been locked by Open Protocol 2- Unlock the tool by sending an Enable tool message via Open Protocol
17	Loosening prohibited	1- Loosening is prohibited 2- The loosening is disabled in the Assembly action 3- The batch count type OK + NOK is used
18	Tool torque out of range	1- The target torque value is above the tool max. torque. 2- Check Pset settings against tool characteristics.
19	Tool communication error	1- Tool communication error. 2- Check tool and cable connections. If the problem occurs again, contact your Desoutter representative for support.
20	Tool LED over current	1-Tool LED are not correctly supplied 2- Disconnect and reconnect the tool. If the problem occurs again, contact your Desoutter representative for support.
21	Number of retries reached	1- The number of retries max has been reached. 2- The tool is locked. 3- The running Assembly Process has to be aborted.
22	Tool locked, lift correct socket	1- The tool is locked. Put all sockets back and lift the correct socket(s) combination.
23	Unsupported tool	1- The tool connected to the controller is not supported. 2- Contact your Desoutter representative for more information.
24	Tool loosening prohibited by VW XML	1- Loosening is disabled by VWXML protocol
25	Tool tightening prohibited by VW XML	1- Tightening is prohibited by VWXML protocol
26	Tool maintenance alarm 1	1- Tool maintenance tightening counter has been reached
27	Tool maintenance alarm number 2	1- Tool maintenance tightening counter has been reached
28	CVI3 and ExBC SW versions incompatible	1 - Battery tool version and controller version are not compatible.
29	The battery is empty	1- The battery is discharged. The tool cannot tighten. 2- Recharge the battery.
30	The battery is low	1- The battery is low. 2- Recharge the battery.
31	Battery error	1- Abnormal battery voltage, the tool cannot tighten. 2- Recharge the battery. If the problem occurs again, replace the battery.

Code no.	Description	Resolution procedure
32	Tool display error	1- Board display malfunction. 2- Contact your Desoutter representative for support.
33	Tool time error	1- The tool time is not set correctly. The tightening results will not be time stamped. 2- Connect the tool to the controller to set date and time.
34	Tool memory error	1- The tool memory does not work properly. 2- Contact your Desoutter representative for support.
35	Tool memory locked	1- The tool memory is locked to protect old data from rewriting. 2- Connect the tool to E-dock to retrieve old data.
36	Tool memory full	1- The tool memory is full. 2- Connect the tool to the controller to empty the memory.
37	Tool trigger error	1- The tool trigger does not work properly. 2- Check and clean the trigger. If the problem occurs again, contact your Desoutter representative for support.
38	Tool logs are available	1- Unexpected tool software exception 2- Log file has been generated by the tool 3-Contact your Desoutter representative for support
39	Tightening Unit config error	1- Tightening Unit settings are invalid
40	Tool over speed	1- Motor speed exceeds 130% of its maximum value. 2- Check tool parameters. 3- Wrong motortune parameters. Contact your Desoutter representative for support.
41	The tool is unauthorized	1- The tool connected to the controller is not authorized. 2 Maximum number of battery tool reached or tightening unit associated doesn't exist anymore 3- Check the ePOD connection and capacity.
42	Tool locked by GeoPositioning	1- Tool has been locked by GeoPositioning 2- Unlock the tool by moving the tool in its defined area
45	Anormal battery high voltage, check your battery	1- Anormal battery high voltage, check your battery. 2- This error can due to charger malfunction or end of life battery.
46	Anormal battery current consumption, check your PSet settings	1- Anormal battery current consumption, check your PSet settings. 2- This error can due to speed settings.
47	Battery is too low, check your battery	1- Battery is too low, check your battery. 2- If the problem occurred again, change the battery with a new one.
48	Battery type not allowed	1- Battery type not allowed. 2- Change your battery type or your configuration.
49	Access denied on controller	Access denied on controller
50	Incompatible network parameters	Incompatible network parameters
51	Epod connected	Epod connected
52	Incorrect network parameters	Incorrect network parameters
53	No TU available	No TU available
54	Pairing success	Pairing success
55	EDock already present on controller	EDock already present on controller
56	Epod disconnected	Epod disconnected
58	Tool locked by GeoTracking	1- Tool has been locked by GeoTracking 2- Unlock the tool by moving the tool in its defined are
59	New tool detected	No procedure
60	Tool synchro ongoing	No procedure
100	Tool cable id invalid parameters	1- Invalid tool cable parameter, check that the tool cable is Desoutter certified 2- Contact your Desoutter representative for support
101	Tool cable id not detected	1- Tool cable communication error, check that the tool cable is Desoutter certified 2- Contact your Desoutter representative for support
102	Tool cable id not certified	1- Tool cable authentication error, check that the tool cable is Desoutter certified 2- Contact your Desoutter representative for support
199	Serial console activated	1- The serial console is activated. 2- Warning, this console is dedicated only to debug purposes and should not be used in production
200	Quick stop activated	1- The quick stop has been activated 2- Check the Phoenix connector
201	Replace backup battery	1- The real time clock backup battery needs to be replaced.
202	Fieldbus connection lost	1- Fieldbus connection with PLC is lost. - no heartbeat is received from PLC - the cable is broken or disconnected - the PLC is off line or not powered 2- Check the Fieldbus configuration.
204	Tool not validated by IO	1- Tool locked by I/O. 2- Check the I/O settings: the "Tool validation" must be active to unlock the tool.
205	Torque settings and tool mismatch	1-Invalid Torque setting, torque is greater than tool characteristics 2-Check Pset settings with the current tool characteristics

Code no.	Description	Resolution procedure
206	Speed settings and tool mismatch	1-Invalid speed setting, speed is greater than tool characteristics 2-Check Pset settings with the tool max. speed.
207	Assembly process done	1- Assembly Process is done, the tool is locked 2- Select new Assembly Process to unlock the tool
208	Invalid run reverse parameters	1-Invalid Run reverse setting, torque or speed are greater than tool characteristics or reverse strategy is not supported 2-Check Pset settings with the current tool characteristics
209	Pset invalid parameters	1 - Software internal error. 2 - Pset is corrupted. Try to transfer it again to the controller. 3 - If the error persists contact your Desoutter representative for support.
210	Invalid Pset selected	1- The Pset currently selected does not match the selectable one in the Assembly Process.
211	Invalid trigger configuration	1- The tool currently connected to the CVI3 is not equipped with the trigger required by the tool trigger configuration 2- Adjust your tool trigger configuration to the tool connected or change the tool according to the expected trigger configuration
212	Result could not be persisted	1- It was not possible to persist the tightening result in the controller 2- Contact your Desoutter representative for support
213	Drive connection lost	1- Connection with the drive has been lost. 2- Reboot the controller. 3- If the issue remains, contact your Desoutter representative.
214	RS232 power short circuit	1- Serial peripheral default. 2- Disconnect and reconnect. 3- Check the serial peripheral.
215	Drive current calibration failed	1- Current calibration failed. 2- Try once again. 3- If the problem occurs again, contact your Desoutter representative for support.
216	Drive current too high	1-Max current exceeded. 2-Contact your Desoutter representative for support
217	Drive disabled	1-Drive disabled by external source. 2-Contact your Desoutter representative for support
218	Drive gate voltage too low	1- Drive hardware failure. 2- Safety issue: contact your Desoutter representative for support
219	Hardware channel failure	1- Drive hardware failure. 2- Safety issue. Contact your Desoutter representative for support.
220	Hardware trip	1- Drive hardware failure. 2- Safety issue. Contact your Desoutter representative for support.
221	Drive heart bit error	1- Drive hardware failure. 2- Safety issue. Contact your Desoutter representative for support.
222	Drive heatsink temperature high	1- Heatsink too warm. 2- Let the controller cool down.
223	Drive init error	1- Software failure. 2- Restart the controller. 3- If the problem occurs again, contact your Desoutter representative for support.
224	Drive junction temperature high	1- Power electronics too warm. 2- Let the controller cool down.
225	Drive missing angle	1- Tool communication error. 2- Check tool and cable connections. If the problem occurs again, contact your Desoutter representative for support.
226	Drive missing torque	1- Tool communication error. Check tool and cable connections. 2- Try once again, if the problem occurs again, contact your Desoutter representative for support.
227	Drive motor stalled	1- Motor stalled (could be missing phase, wrong motortune or power electronics failure) 2- Try once again, if the problem occurs again, contact your Desoutter representative for support.
228	Drive Software Error	1- Software failure 2- Restart the controller. 3- If the problem occurs again, contact your Desoutter representative for support
229	Drive PWM watchdog error	1- Software failure. 2- Restart the controller. 3- If the problem occurs again, contact your Desoutter representative for support.
230	Drive DC bus voltage high	1- Max current exceeded. DC-bus voltage high 2- Contact your Desoutter representative for support
231	Drive DC bus voltage too low	1- Power failure. DC-bus voltage low 2- Contact your Desoutter representative for support.
232	Fieldbus module not recognized not a Desoutter one	1- The Fieldbus module plugged in the controller cannot be run. It is not an authorized Desoutter module. 2- Contact your Desoutter representative for more information.
233	CVINet FIFO full	1- The CVINet result FIFO is full, the CVINet connection has been lost 2- Check the CVI3 Ethernet cable 3- Check CVI3 Ethernet configuration 4- Check if CVINet is running correctly

Code no.	Description	Resolution procedure
234	Fieldbus module mismatch	1-The Fieldbus module declared in configuration is not the same that the one present in controller (e.g. Profibus declared but a Profinet module in CVI3).
235	Warning max speed setting	1- Invalid speed setting: speed is greater than tool characteristics 2- By default, speed setting has been replaced with tool max speed.
236	ToolsNet FIFO full	1- The ToolsNet result FIFO is full, the CVINet connection has been lost 2- Check the CVI3 Ethernet cable 3- Check CVI3 Ethernet configuration 4- Check if ToolsNet is running correctly
237	Fieldbus invalid process data	1- The Fieldbus mapping has too many items.
238	Fieldbus invalid device address	1- The device address affected to Fieldbus is invalid.
239	Fieldbus invalid communication settings	1- Fieldbus communication settings are invalid
240	VW XML protocol not authorized	1- The selected XML protocol is not authorized (check the ePOD characteristics)
241	CVINET FIFO alarm	1- The CVINet result FIFO has reached alarm threshold, the CVINet connection has been lost 2- Check the CVI3 Ethernet cable 3- Check CVI3 Ethernet configuration 4- Check if CVINet is running correctly
242	ToolsNet FIFO alarm	1- The ToolsNet result FIFO has reached alarm threshold, the CVINet connection has been lost 2- Check the CVI3 Ethernet cable 3- Check CVI3 Ethernet configuration 4- Check if ToolsNet is running correctly
243	PFCS not authorized	1- The selected PFCS protocol is not authorized (check the ePOD characteristics)
244	Accessory disconnected	1- The accessory at the given address has been disconnected from the eBUS of the CVI3. 2- Check the accessory cable.
245	Wait for report acknowledgement	Acknowledge report with its corresponding input
246	Problem in synchro I/O cable or configuration	1- Error detected on synchronisation input 2- Check the configuration of I/O 3- Check the synchronisation cable
247	Conflict of versions for XML protocol	1- Conflict detected in Audi / VW XML protocol version. 2- Check the coherence of the version between the controller and master PC/PLC
248	SAS order fail	1- Fieldbus SAS order has failed. 2- Check the value of RRG1, SIO, etc.
249	XML PRG value set by PLC is 0	1- The PRG value 0 has been set by Fieldbus.
250	Pset corrupted	1- Pset is not defined correctly 2- Check the Pset
251	No Pset selected	1- No Pset is selected 2- Select a Pset before start order
252	No tool involved	1- No tool is involved for the requested tightening 2- Check tool validation
253	Incorrect tool Id defined in Pset	1- Pset is not defined correctly. 2- One tool declared in the Pset is not part of the tightening unit 3- Check the Pset.
254	Drive communication error	1- Error detected in drive communication 2- Restart the controller 3- If the problem occurs again, contact your Desoutter representative for support
255	Drive choke too hot	1- Power electronics too warm. 2- Let the controller cool down.
256	Tool motor too hot	1- Tool is locked because its maximum motor temperature has been reached. 2- Tool will remain locked until the motor temperature comes back to its normal value.
257	Impossible to start remotely	1- Verify the tool trigger is correctly pushed
258	Calibration need Pset mode for this TU	1- For tool calibration, the Tightening Unit has to be in Pset mode 2- Change the Tightening Unit mode into Pset mode.
259	Reset input is active	1- "Reset" input is active 2- The Tightening Unit will unlock when input switches to inactive state.
260	IPM protocol not authorized	1- The selected IPM protocol is not authorized (check the ePOD connection)
261	Locked by IPM	1- IPM protocol has locked the controller 2- Check the connection with the IPM gateway 3- Check CVI3 IPM configuration
262	Open Protocol connection lost	1- Open protocol connection has been lost
263	Socket tray conflict	For this Tightening Unit, do not associate more than one socket combination to a Pset
264	Too many steps in PSet	Check that an Epod3 is connected to the controller to enable more steps per pset
265	Socket(s) usable with more than one TU	Reconfigure sockets combination to resolve conflicts
266	Message:	Incoming message received with dynamic text
267	Result transfer error	Result transfer error
268	CVI3 and CVI NET SW versions incompatible	CVI Net and CVI3 are incompatible. Please update CVI Net software
269	Pset modified	No procedure

Code no.	Description	Resolution procedure
300	Save log started	1- Saving the CVI3 logs to USB key has started
301	Save log done	1- Saving the CVI3 logs to USB key has ended
310	Identifier accepted	1- An identifier has been received and accepted. 2- The identifier is matching an Assembly process start condition
311	Identifier rejected	1- An identifier has been received 2- The identifier does not match any Assembly process start condition
312	Access right expired	1- The access rights on the USB key cannot be read 2- Unplug the key and insert it again 3- If the issue is persistent, the access right file is probably corrupt 4- Contact your CVI Key administrator.
313	Access right unreadable	1- The access rights on the USB key could not be read 2- Try unplug the key and insert it again 3- If the issue is persistent, the access right file is probably corrupt contact your CVI Key administrator
314	CVIKey plugged	1- an access key has been plugged
315	CVIKey unplugged	1- an access key has been unplugged
316	Barcode lost	no procedure
400	Default network configuration set	1- Network configuration has been set to default.
401	Network configuration failed	1- Network configuration failed. 2- Check your settings. 3- If the problem occurs again, contact your Desoutter representative for support.
500	CVILogix user info	Message generated by CVILOGIX program
501	CVILogix user info	Message generated by CVILOGIX program
502	CVILogix user info	Message generated by CVILOGIX program
888	Controller software updated	no procedure
889	Device Software Updated	Device Software Updated
890	Device Software Error	Device Software Error
891	Controller started	No procedure
899	Software downgrade not allowed	1- The SW downgrade is not allowed for this version 2- Check the CVI3 image version on your USB key 3- If the update is still failing, contact your Desoutter representative
900	CVI3 Software update failed	1- The SW upgrade failed 2- Do not remove the USB key and try to restart the CVI3 3- If the upgrade is still failing, contact your Desoutter representative
901	CVI3 Software image not found	1- The SW upgrade failed, no CVI3 image (*.cvi3) was found at the USB key root directory 2- Check your USB key, it must have only one CVI3 image
902	CVI3 Software image invalid	1- The SW upgrade failed, the CVI3 image copied on your USB key is corrupted 2- Remove and copy again your CVI3 image 3- Try another USB key 4- Contact your Desoutter representative for more information
903	CVI3 Software updater missing	1- The SW updater is not available or broken 2- Contact your Desoutter representative for more information
904	CVI3 save parameter utility not found	1- The save parameters utility is not available 2- Contact your Dessouter representative for upgrade
905	CVI3 save parameter to key failed. Key is full	1- Your USB key is full, all data were not saved 2- Delete your old backup files and try again
906	CVI3 save parameter failed	1- An error occurred during backup, data were not saved. 2- Check the available space on your key, delete files and try again. 3- If the problem persists, contact the Desoutter support team.
907	Wrong USB port	1- Your USB device is plugged into the wrong port 2- If your device is a USB key, plug it into the USB front port 3- If your device is a USB barcode reader or keyboard, plug it into the bottom USB ports
908	Too many USB HID devices connected	1- Too many USB devices (barcode reader or keyboard) are plugged to the controller 2- Remove all devices and plug them again to the bottom USB ports only.
909	USB HID device error	1- Your USB device is not supported by the CVI3 controller 2- Only USB barcode reader and USB keyboard are supported, if you use one of them, contact your Dessouter representative for upgrade
910	CVILOGIX save error	1- Plug a USB key to the front panel. 2- Check available space on your USB key, delete some old backup and try again.
911	CVILOGIX load error	1- Plug a USB key to the front panel. 2- The .zip file was not found, check that it is in the correct directory.
912	ePOD backup failed	1- Check the ePOD connection. 2- Contact your Desoutter representative for support.
913	ePOD restore failed	1- Check the ePOD connection. 2- Contact your Desoutter representative for support.
914	Maintenance ongoing	Maintenance ongoing: Refer to user manual
915	Inconsistent version	1- The SW version of all CVI3 controllers must be identical 2- Update firmware

Code no.	Description	Resolution procedure
916	Workgroup not authorized	1- You need to connect an epod3 on the Workgroup Primary controller
917	Invalid accessory configuration	1-The accessory configuration is not correct 2-Check type of elements and events associated
918	Emergency stop activated	1- The emergency stop has been activated 2- Check the M8 connector
919	additional transducer configuration error	1- The additional transducer's maximum torque is lesser than the embedded transducer's maximum torque 2- The Pset uses an additional transducer though non is installed on tool
920	Controller reset to factory settings	ePod automatic backup must be configure again if needed
921	Pset execution is not authorized	1-Check used features allowance 2-Contact your Desoutter representative for support
922	Additional transducer span failure	1- Span value from additional torque sensor is outside bounds. 2 -Try once again to start the tool with no mechanical constraints. If the problem occurs again, contact your Desoutter representative for support
923	Additional transducer offset failure	1- Offset value from additional torque sensor is outside bounds. 2- Try once again to start the tool with no mechanical constraints. If the problem occurs again, contact your Desoutter representative for support.
924	Tool calibration required	1-Perform a calibration of the tool on CVI3

1 - DATA MAPPING TYPES AND VARIABLES

1.1 - Data type

- Choose the type of the data representation in memory:

Format	Description	Size (bytes)
Float	Floating point (IEE754)	4
Char	ASCII string	1..128
Uint32	Unsigned 32 bits	4
Uint16	Unsigned 16 bits	2
Uint8	Unsigned 8 bits	1
Sint32	Signed 32 bits	4
Sint16	Signed 16 bits	2
Sint8	Signed 8 bits	1
Bool	Boolean	1
INT16 DEC16	Integer part on 16 bits + decimal part on 16 bits.	4

1.2 - Char (ASCII string)

If you choose "Char", extra parameters are necessary to set the ASCII string:

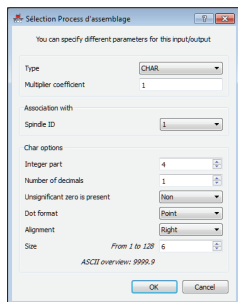

The "Size" is automatically computed. However, you can put a value to truncate value in memory.

1.3 - Alignment

The floating point and integer values are first converted into a chain of characters and then aligned according to the selected option within the total size of the field.

Examples (green background denoting effective field length)

CVI3 value	Configuration						Data in PLC memory				
	Integer part	Dot format	Number of decimals	Size	Insignificant zero	Alignment					
4	4	No	0	4	No	Right			4		
4	4	No	0	4	No	Center		4			
4	4	No	0	4	No	Left	4				
4	2	Point	1	6	No	Right			4	.	0
4	2	Point	1	6	No	Center		4	.	0	
4	2	Point	1	6	No	Left	4	.	0		
4	4	No	0	4	Yes	Right	0	0	0	4	
4	4	No	0	4	Yes	Center	0	0	0	4	
4	4	No	0	4	Yes	Left	0	0	0	4	
4	2	No	0	4	Yes	Right			0	4	
4	2	No	0	4	Yes	Center	0	4			
4	2	No	0	4	Yes	Left	0	4			

- Note that in case of centering if the resulting string of characters cannot be centered perfectly, more spaces are added on the left side of the string.

1.4 - Saturation

If the value exceeds the capacity of representation by the output string, then the maximal representable value is used instead.

Examples (alignment always "Right", green background denoting effective field length)

CVI3 value	Configuration				Data in PLC memory					
	Integer part	Dot format	Number of decimals	Size						
10000	4	No	0	4	9	9	9	9		
-10000	4	No	0	4	-	9	9	9		
99,99	4	No	0	4			9	9		
-99,99	4	No	0	4		-	9	9		
100	2	Dot	2	6		9	9	.	9	9
-100	3	Dot	2	6	-	9	9	.	9	9
-100	2	Dot	2	6		-	9	.	9	9
100	1	Dot	1	3	9	.	9			
-100	1	Dot	1	3	-	.	9			
10	1	No	0	1	9					
-1	1	No	0	1	0					

• Note that the "insignificant zeroes present" option has no impact on the maximal representable value.

1.5 - UINT32 UINT16 UINT8

Data are represented as unsigned integer binary. If value exceeds the capacity of selected type, then the maximal value of the specified type is used. Negative can not be represented.

Examples:

CVI3 value	Data in PLC memory		
	UINT8	UINT16	UINT32
99,99	99 (0x63)	99 (0x0063)	99 (0x00000063)
-99,99	0 (0x00)	0 (0x0000)	0 (0x0000000000)
999,9	255 (0xFF)	999 (0x03E7)	999 (0x000003E7)
9999	255 (0xFF)	9999 (0x270F)	9999 (0x0000270F)
9999,9	255 (0xFF)	9999 (0x270F)	9999 (0x0000270F)
99999	255 (0xFF)	65535 (0xFFFF)	99999 (0x0001869F)

1.6 - SINT32 SINT16 DINT8

Data are represented as signed integer binary. If value exceeds the capacity of selected type, then the maximal value of the specified type is used.

Examples:

CVI3 value	Data in PLC memory		
	INT8	SINT16	SINT32
99,99	99 (0x63)	99 (0x0063)	99 (0x00000063)
-99,99	-99 (0x9D)	-99 (0xFF9D)	-99 (0xFFFF9D)
999,9	127 (0x7F)	999 (0x03E7)	999 (0x000003E7)
9999	127 (0x7F)	9999 (0x270F)	9999 (0x0000270F)
9999,9	127 (0x7F)	9999 (0x270F)	9999 (0x0000270F)
99999	127 (0x7F)	16383 (0x7FFF)	99999 (0x0001869F)

1.7 - BOOL

Data are represented as a boolean using 1 byte (8 bits) signed integer binary. If value is equal to zero, then value seen by PLC is 0, otherwise value is 1. Negative values cannot be represented using this type.

Examples:

CVI3 value	Data in PLC memory
0	0
99,99	1
-99,99	0
999,9	1
9999	1
9999,9	1
99999	1

1.8 - INT16 DEC16

In this format, the integer is expressed in binary format in 16 bits and decimal part in the remaining 16 bits. The total number of digits is 4 and maximum number of digits is 2 which can be summarized as follows:

Digits for integer part	Digits for decimal part
1	2
2	2
3	1
4	0

Negative values cannot be represented using this format.

Examples:

CVI3 value	Data in PLC memory		
	Integer part	Decimal part	Complete value
99,99	99 (0x63)	99 (0x63)	0x00630063
-99,99	0	0 (0x0)	0x00000000
999,9	999 (0x03E7)	9 (0x9)	0x03E70009
9999	9999 (0x270F)	0 (0x0)	0x270F0000
9999,9	9999 (0x270F)	0 (0x0)	0x270F0000

1.9 - Multiplier coefficient

This coefficient is a value which is multiplied with the variable before being copied in memory. For example, you set "Multiplier Coefficient" to 10 ; then if the variable is equal to 2 then PLC will read 20 (=2x10).

1.10 - Inputs variables

Inputs variables are data coming from the controller and sent to the PLC.

Name	Description	ASCII values	Numerical values or binary format	Reset condition	Set condition
General Status					
Controller name	Controller name			Never	CVi3 start or new configuration
Tightening unit name	Tightening Unit name			Never	CVi3 start or new configuration
CVI3 outputs	State of the 8 controller outputs				
"Identifier %1 ... Identifier %4"	Identifier #1 stored in result.			Tight start	Result received
User info code	"Info, error or warning" value displayed			Error, warning or info displayed.	"List of error and warning empty."
Constant	Used to set a constant read by the PLC.				
Keep alive value ack.	Mirror of "Keep Alive" value in PLC output.			Controller start	New value in Keep Alive Value
User Variable 1 ack.	Mirror of User Variable 1 in PLC output			Controller start	New value in User Variable 1
User variable 2 ack.	Mirror of User Variable 2 in PLC output			Controller start	New value in User Variable 2
Identifier echo	Last accepted identifier			Controller start	New value in User Variable 2
Tool Status					
Tool model	Tool model connected (e.g. EAD50-900)	-	-	Tool disconnection	Tool connection
Tool serial number	Tool serial number	-	-	Tool disconnection	Tool connection
Tool max torque	Tool maximum torque in TU units	-	-	Tool disconnection	Tool connection
Tool max speed	Tool maximum speed in rpm	-	-	Tool disconnection	Tool connection
Spindle comment	Comment written in tool memory.	-	-	Tool disconnection	Tool connection
Tool calibration value 1	Calibration value for tool sensor 1	-	-	Tool disconnection	Tool connection
Tool calibration value 2	Calibration value for tool sensor 2	-	-	Tool disconnection	Tool connection

Name	Description	ASCII values	Numerical values or binary format	Reset condition	Set condition
Pset Status					
Pset selected	If of Pset currently selected				
Tightening result	Tightening result	"A" = accepted "R" = rejected"	"0 = no result 1 = accepted 2 = rejected"	Tight start	Result received
Final torque	Final torque in N.m. (last step); if used with additional transducer this value concerns the value of the transducer in charge of control.			Tight start	Result received
Torque trend	Torque trend (last step); if used with additional transducer this value concerns the value of the transducer in charge of control.	"" "" "<" ">" "=""	"0 = no result 1 = min 2 = max 3 = accepted"	Tight start	Result received
Min. torque	Min torque (last step); if used with additional transducer this value concerns the value of the transducer in charge of control.			Tight start	Result received
Target torque	Target torque (last step); if used with additional transducer this value concerns the value of the transducer in charge of control.			Tight start	Result received
Max torque	Max torque (last step); if used with additional transducer this value concerns the value of the transducer in charge of control.			Tight start	Result received
Final angle	Final angle in degrees (last step); if used with additional transducer this value concerns the value of the transducer in charge of control.			Tight start	Result received
Angle trend	Angle trend (last step); if used with additional transducer this value concerns the value of the transducer in charge of control.	"" "" "<" ">" "=""	"0 = no result 1 = min 2 = max 3 = accepted"	Tight start	Result received
Min. angle	Min angle in degrees (last step); if used with additional transducer this value concerns the value of the transducer in charge of control.			Tight start	Result received
Target angle	Target angle in degrees (last step); if used with additional transducer this value concerns the value of the transducer in charge of control.			Tight start	Result received
Max. angle	Max angle in degrees (last step); if used with additional transducer this value concerns the value of the transducer in charge of control.			Tight start	Result received
Final current	Final current in Amps (last step)			Tight start	Result received
Current trend	Current trend (last step)	"" "" "<" ">" "=""	"0 = no result 1 = min 2 = max 3 = accepted"	Tight start	Result received
Min current	Min current in Amps (last step)			Tight start	Result received
Max. current	Max current in Amps (last step)			Tight start	Result received
Final current %	Current in %			Tight start	Result received
Min. current %	Current in %			Tight start	Result received
Max. current %	Current in %			Tight start	Result received
Rundown speed	Rundown speed in rpm			Tight start	Result received
Downshift speed	Downshift speed in rpm			Tight start	Result received
Downshift torque	Downshift torque threshold			Tight start	Result received
Angle threshold	Threshold (in TU units) used to start angle measure.			Tight start	Result received
Torque offset	Torque offset applied			Tight start	Result received
Final torque without offset	Real torque applied to the joint without considering torque offset			Tight start	Result received

Name	Description	ASCII values	Numerical values or binary format	Reset condition	Set condition
Min torque rate in N.m/° (setting)	Min torque rate in N.m/° (setting)			Tight start	Result received
Target torque rate in N.m/° (setting)	Target torque rate in N.m/° (setting)			Tight start	Result received
Max. torque rate in N.m/° (setting)	Max torque rate in N.m/° (setting)			Tight start	Result received
Final (result) torque rate in N.m/°	Final (result) torque rate in N.m/°			Tight start	Result received
Torque rate trend	Torque rate trend	<pre> "0" "0" "1"<"0" "2">"0" "3"="0" </pre>	"0 = no result 1 = min 2 = max 3 = accepted"	Tight start	Result received
Yield ratio in %	Yield ratio in % of N.m/°(setting)			Tight start	Result received
Min prevailing in N.m	Min prevailing in N.m			Tight start	Result received
Max prevailing in N.m	Max prevailing in N.m			Tight start	Result received
Min prevailing in N.m (setting)	Min prevailing in N.m (setting)			Tight start	Result received
Max prevailing in N.m (setting)	Max prevailing in N.m (setting)			Tight start	Result received
Final prevailing in N.m	Final (result) prevailing in N.m			Tight start	Result received
Prevailing trend	Prevailing trend	<pre> "0" "0" "1"<"0" "2">"0" "3"="0" </pre>	"0 = no result 1 = min 2 = max 3 = accepted"	Tight start	Result received
Result type	Type of the result.		"0 : no result 1 : tightening 2 : run-reverse"	Tight start	Result received
Final torque (monitoring transducer)	Final torque (monitoring) in N.m. (last step)			Tight start	Result received
Torque trend (monitoring transducer)	Torque trend (monitoring) (last step)	<pre> "0" "0" "1"<"0" "2">"0" "3"="0" </pre>	"0 = no result 1 = min 2 = max 3 = accepted"	Tight start	Result received
Final angle (monitoring transducer)	Final angle (monitoring) in degrees (last step)			Tight start	Result received
Angle trend (monitoring transducer)	Angle trend (monitoring) (last step)	<pre> "0" "0" "1"<"0" "2">"0" "3"="0" </pre>	"0 = no result 1 = min 2 = max 3 = accepted"	Tight start	Result received
Result ID	Result ID			Tight start	Result received
Step number	Last executed step number			Tight start	Result received
Assembly Process Status					
AP selected	Id of Assembly process currently selected				
Batch size	Batch size (related to assembly process)			Tight start	Result received
Batch count	Batch count (related to assembly process)			Tight start	Result received
Batch remaining	Batch remaining (related to assembly process)			Tight start	Result received

Name	Description	ASCII values	Numerical values or binary format	Reset condition	Set condition
Socket tray					
Socket lifted	Socket lifted. If a socket is left on CVI2 socket tray then sockets on CVI3 socket tray are not considered.			Never	Socket lifted
Socket lifted as bit	Socket lifted, each bit is encoding one socket (Socket tray must be in external mode). If a socket is left on CVI2 socket tray then sockets on CVI3 socket tray are not considered.			Never	Socket lifted
Socket Lifted and its address	Socket Lifted and its address (keep last address in case no sockets are lifted)	"DDLLL DD : deviceID LLL : lifted socket (255 if more than 1 socket)."	"Byte0 = DeviceID Byte1 = lifted socket position (255 if more than 1 socket)."	Never	Socket lifted
Customized protocol Status					
Q_PRG	Selected program number				
IIO_INO	"IIO : number of OK on 4 bits INO : number of OK on 4 bits"				
TSC	Place for status code				
Q_PI1	Ack workpiece-ID				
Q_FNR	Receiving tightening case number				
Q_TNR	Receiving tightening location number				
ECL	Error class				
ERC	Error code				
VEN	Controller brand code				
TYP	Controller type code	-	-	-	-
CVILOGIX outputs					
"CVILOGIX %1 CVILOGIX %100"	CVILOGIX variable (1 to 100)	-	-	-	-

1.11 - Events in PLC input

All output events can be associated to PLC inputs in Fieldbus.

For each event, you can choose to invert or not the signal.

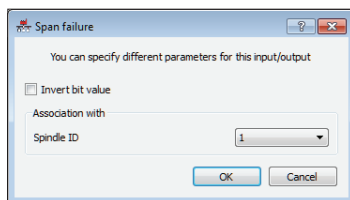

1.12 - Outputs variables

Name	Description
General commands	
CVI3 inputs	State of the 8 controller inputs that can be forced by the PLC.
Identifier	Identifier (e.g. VIN number) which can be used to start an assembly process
Keep alive value	Value that will be copied in Keep Alive Value Ack. Value change can be used as heartbeat management.
User variable 1	A variable freely settable by user. No treatment is made on this value. This value is copied in User Variable 1 Ack.
User variable 2	A variable freely settable by user. No treatment is made on this value. This value is copied in User Variable 2 Ack.
Date synchro data	"Date synchronisation data. Format is YYYYMMDD in ASCII."
Time synchro data	"Time synchronisation data. Format is HHMMSS in ASCII"
Pset commands	
Pset selection	ID of Pset expected by PLC
Assembly Process commands	
AP selection	"Id of Assembly process expected by PLC. If the Assembly process #0 is requested, then the current assembly process is aborted. The controller behavior can be adapted by using the "Assembly process" panel in general configuration"
Socket tray	
Socket green led as bit	Control green led of socket trays. In binary each bit is encoding one socket. In ASCII each digit is encoding one socket. Socket tray must be in external mode.
Socket red led as bit	Control red led of socket trays. In binary each bit is encoding one socket. In ASCII each digit is encoding one socket. Socket tray must be in external mode.
Customized protocol Status	
PRG	Tightening program number in range 1-255.
SIO_MNO	"SIO : number of OK on 4 bits MNO : max number of NOK on 4 bits"
CIO_CNO	"CIO : class for OK tightenings on 4 bits CNO : class for NOK tightenings on 4 bits"
PRT	Model description.
PI1	Unique workpiece ID
STC_VAR	"STC : XML 2.0 VAR : XML 2.1"
FNR	Tightening case number
TNR	Tightening location number
WID	Workpiece carrier-ID
PNR	Profinet XML version
CVILOGIX inputs	
"CVILOGIX %1 ... CVILOGIX %100"	CVILOGIX variable (1 to 100)

1.13 - Events in PLC output

All input events described in CVI3 User Manual can be associated to PLC output in Fieldbus. For each event you can choose to invert or not the signal. Note that you can associate up to 4 input events to a unique bit in PLC output. This allows you to set several events at the same time.

1.14 - Bypass between PLC and IO

For some reasons, you may want to directly control CVI3 inputs/outputs by PLC without any treatment on it.

External input/output bits are dedicated to this usage.

Example: to read a CVI3 physical in PLC memory.

- First, associate a CVI3 input to an “External inputs PLC bit” in “I/O and accessories” panel:
- Secondly, associate the “external PLC bit” to the PLC Inputs.

You can now read in PLC the state of CVI3 physical input.

The principle is the same for the outputs.

2 - MODULES DETAILED DESCRIPTION

2.1 - DeviceNet

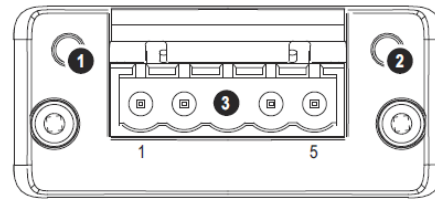

#	Item
1	Network Status LED
2	Module Status LED
3	DeviceNet Connector

Network Status

State	Indication
Off	Not online / No power
Green	On-line, one or more connections are established
Flashing Green (1 Hz)	On-line, no connections established
Red	Critical link failure
Flashing Red (1 Hz)	One or more connections timed-out
Alternating Red/Green	Self test

Module Status

State	Indication
Off	No power
Green	Operating in normal condition
Flashing Green (1 Hz)	Missing or incomplete configuration, device needs commissioning
Red	Unrecoverable Fault(s)
Flashing Red (1 Hz)	Recoverable Fault(s)
Alternating Red/Green	Self test

DeviceNet Connector

This connector provides DeviceNet connectivity.

Pin	Signal	Description
1	V-	Negative bus supply voltage *
2	CAN L	CAN low bus line
3	SHIELD	Cable shield
4	CAN H	CAN high bus line
5	V+	Positive bus supply voltage *

* DeviceNet bus power. For more information, refer to DeviceNet “Technical Specification”.

2.2 - Ethernet/IP

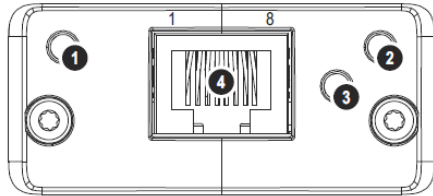

#	Item
1	Network Status LED
2	Module Status LED
3	Link/Activity
4	Ethernet Interface

Network Status LED



A test sequence is performed on this LED during startup.

LED State	Description
Off	No power or no IP address
Green	On-line, one or more connections established (CIP Class 1 or 3)
Green, flashing	On-line, no connections established
Red	Duplicate IP address, FATAL error
Red, flashing	One or more connections timed out (CIP Class 1 or 3)

Module Status LED



A test sequence is performed on this LED during startup.

LED State	Description
Off	No power
Green	Controlled by a Scanner in Run state
Green, flashing	Not configured, or Scanner in Idle state
Red	Major fault (EXCEPTION-state, FATAL error etc.)
Red, flashing	Recoverable fault(s)

LINK/Activity LED

LED State	Description
Off	No link, no activity
Green	Link established
Green, flickering	Activity

Ethernet Interface

The Ethernet interface supports 10/100Mbit, full or half duplex operation.

CVI3 Ethernet IP module characteristics

Speed	10 and 100Mbps/s supported
Duplex	Half and full supported
EDS file release	2.2
WebServer	Internal webserver in module allowing setting connection parameters (IP address).

2.3 - Profibus

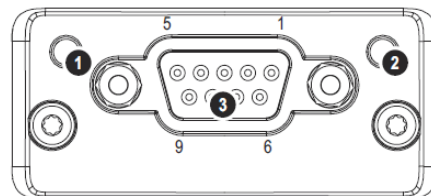

#	Item
1	Operation Mode
2	Status
3	PROFIBUS Connector

Operation Mode

State	Indication
Off	Not online / No power
Green	On-line, data exchange
Flashing Green	On-line, clear
Flashing Red (1 flash)	Parametrization error
Flashing Red (2 flashes)	PROFIBUS Configuration error

Status

State	Indication	Comments
Off	No power or not initialized	state = 'SETUP' or 'NW INIT'
Green	Initialized	module has left the 'NW INIT' state
Flashing Green	Initialized, diagnostic event(s) present	Extended diagnostic bit is set
Red	Exception error	state = 'EXCEPTION'

PROFIBUS Connector (DB9F)

Pin	Signal	Description
1	-	-
2	-	-
3	B Line	Positive RxD/TxD, RS485 level
4	RTS	Request to send
5	GND Bus	ground (isolated)
6	+5V Bus Output *	+5V termination power (isolated, short-circuit protected)
7	-	-
8	A Line	Negative RxD/TxD, RS485 level
9	-	-
Housing	Cable Shield	Internally connected to the protective earth via cable shield filters according to the PROFIBUS standard.

* The current drawn from this pin will affect the total power consumption. To simplify development, the output supplies up to 60mA when operated in room temperature (20 - 22 degrees Celsius), which is sufficient to power e.g. master simulators etc. During normal operating conditions (or higher temperatures), i.e. in an industrial environment, the specified max. current for this output is 10mA.

2.4 - Profinet 1 port

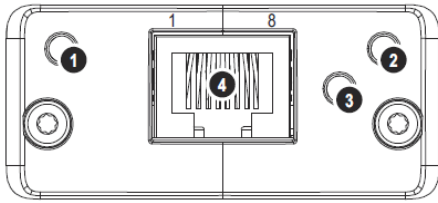

#	Item
1	Network Status LED
2	Module Status LED
3	Link/Activity LED
4	Ethernet Interface

Network Status LED



A test sequence is performed on this LED during startup.

LED State	Description	Comments
Off	Offline	- No power - No connection PLC
Green	Online (RUN)	- Connection with PLC established - PLC in RUN state
Green, flashing	Online (STOP)	- Connection with PLC established - PLC in STOP state

Module Status LED



A test sequence is performed on this LED during startup.

LED State	Description	Comments
Off	Not Initialized	No power - or - Module in 'SETUP' or 'NW INIT' state
Green	Normal Operation	Module has shifted from the 'NW INIT' state
Green, 1 flash	Diagnostic Event(s)	Diagnostic event(s) present
Green, 2 flashes	Blink	Used by engineering tools to identify the node on the network
Red	Exception Error	Module in state 'EXCEPTION'
Red, 1 flash	Configuration Error	Expected Identification differs from Real Identification
Red, 2 flashes	IP Address Error	IP address not set
Red, 3 flashes	Station Name Error	Station Name not set
Red, 4 flashes	Internal Error	Module has encountered a major internal error

LINK/Activity LED

LED State	Description	Comments
Off	No Link	No link, no communication present
Green	Link	Ethernet link established, no communication present
Green, flickering	Activity	Ethernet link established, communication present

Ethernet Interface

The Ethernet interface operates at 100Mbit, full duplex, with auto-negotiation enabled as default.

2.5 - Profinet 2 ports

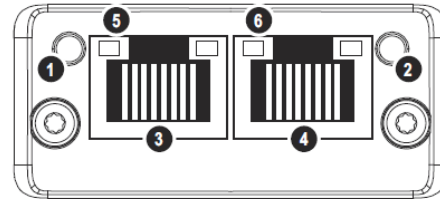

#	Item
1	Network Status LED
2	Module Status LED
3	Ethernet (port 1)
4	Ethernet (port 2)
5	Link/Activity LED (port 1)
6	Link/Activity LED (port 2)

Network Status LED



A test sequence is performed on this LED during startup.

LED State	Description	Comments
Off	Offline	- No power - No connection with PLC
Green	Online (RUN)	- Connection with PLC established - PLC in RUN state
Green, flashing	Online (STOP)	- Connection with PLC established - PLC in STOP state

Module Status LED



A test sequence is performed on this LED during startup.

LED State	Description	Comments
Off	Not Initialized	No power - or - Module in 'SETUP' or 'NW INIT' state
Green	Normal Operation	Module has shifted from the 'NW INIT' state
Green, 1 flash	Diagnostic Event(s)	Diagnostic event(s) present
Green, 2 flashes	Blink	Used by engineering tools to identify the node on the network

LED State	Description	Comments
Red	Exception Error	Module in state 'EXCEPTION'
Red, 1 flash	Configuration Error	Expected Identification differs from Real Identification
Red, 2 flashes	IP Address Error	IP address not set
Red, 3 flashes	Station Name Error	Station Name not set
Red, 4 flashes	Internal Error	Module has encountered a major internal error

LINK/Activity LED

LED State	Description	Comments
Off	No Link	No link, no communication present
Green	Link	Ethernet link established, no communication present
Green, flickering	Activity	Ethernet link established, communication present

Ethernet Interface

The Ethernet interface operates at 100Mbit, full duplex, as required by PROFINET.

2.6 - Profinet IRT

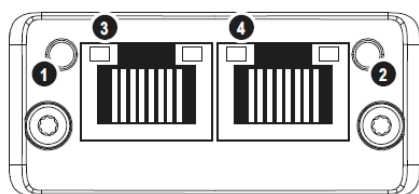

#	Item
1	Network Status LED
2	Module Status LED
3	Link/Activity LED (port 1)
4	Link/Activity LED (port 2)

Network Status LED



A test sequence is performed on this LED during startup.

LED State	Description	Comments
Off	Offline	- No power - No connection with IO controller
Green	Online (RUN)	- Connection with IO controller established - IO controller in RUN state
Green, 1 flash	Online (STOP)	- Connection with IO controller established - IO controller in STOP state or - IO data bad - IRT synchronization not finished
Green, blinking	Blink	Used by engineering tools to identify the node on the network

LED State	Description	Comments
Red	Fatal event	Major internal error (this indication is combined with a red module status LED)
Red, 1 flash	Station Name error Station	Station Name not set
Red, 2 flashes	IP address error	IP address not set
Red, 3 flashes	Configuration error	Expected Identification differs from Real Identification

Module Status LED



A test sequence is performed on this LED during startup.

LED State	Description	Comments
Off	Not Initialized	No power - or - Module in 'SETUP' or 'NW INIT' state
Green	Normal Operation	Module has shifted from the 'NW INIT' state
Green, 1 flash	Diagnostic Event(s)	Diagnostic event(s) present
Red	Exception Error	Device in state 'EXCEPTION'
	Fatal event	Major internal error (this indication is combined with a red network status LED)
Alternating Red/Green	Firmware update	• Do NOT power off the module. Turning the module off during this phase could cause permanent damage.

LINK/Activity LED

LED State	Description	Comments
Off	No Link	No link, no communication present
Green	Link	Ethernet link established, no communication present
Green, flickering	Activity	Ethernet link established, communication present

Ethernet Interface

The Ethernet interface operates at 100Mbit, full duplex, as required by PROFINET.

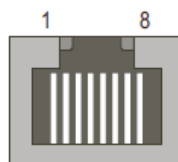

Pin no.	Description
1, 2, 4, 5	Connected to chassis ground over serial RC circuit
3	RD-
6	RD+
7	TD-
8	TD+
Housing	Cable shield

2.7 - CC-Link

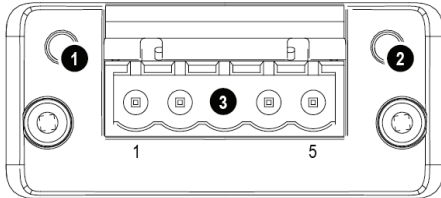

#	Item
1	Run LED
2	Error LED
3	CC-Link interface

Run LED



A test sequence is performed on this LED during startup.

LED State	Description
Off	No network participation, timeout status (no power)
Green	Participating, normal operation
Red	Major fault (FATAL error)

Error LED

LED State	Description
Off	No error detected (no power)
Red	Major fault (Exception or FATAL event)
Red, flickering	CRC error (temporary flickering)
Red, flashing	Station Number or Baud rate has changed since startup (flashing)

CC-Link Interface

Pin	Signal	Description
1	DA	Positive RS485 RxD/TxD
2	DB	Negative RS485 RxD/TxD
3	DG	Signal Ground
4	SLD	Cable Shield
5	FG	Protective Earth

APPENDIX - CONNECTIONS

1 - TOOL CONNECTOR

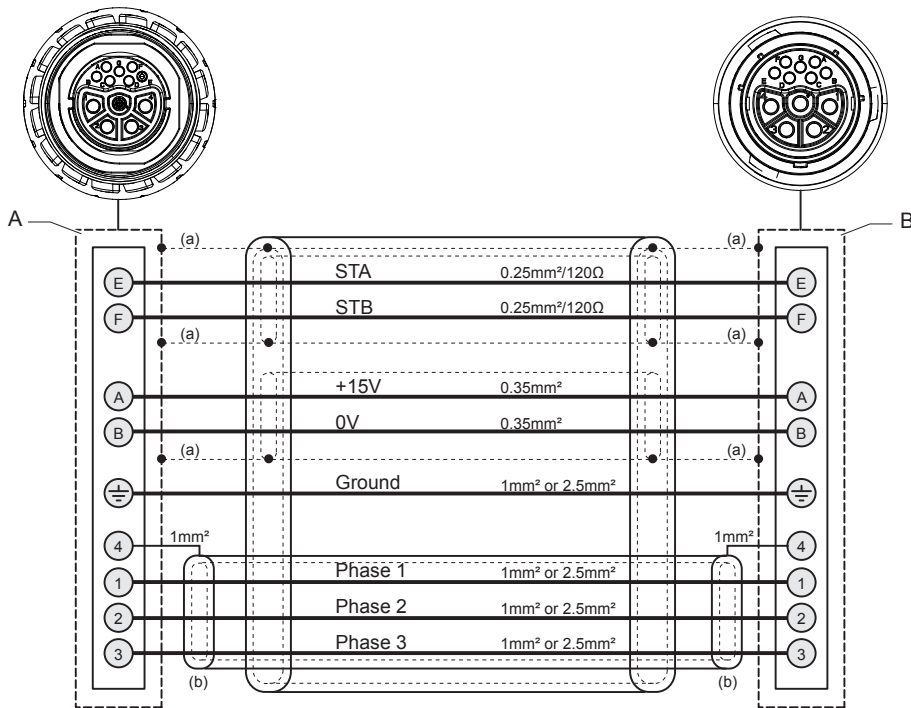

Legend

- A Connector 12 pts Male
- B Connector 12 pts Female
- a Ground shielded cable
- b **WARNING : Shielded insulate**

STA	Twisted pairs: 2x0.25 mm ²
STB	at 10 MHz 65 Ω

Cable	Color
STA	Red
STB	Red / Blue
+15V	Black / Blue
0V	Black
Ground	Yellow / Green
Phase 1	Black
Phase 2	Brown
Phase 3	Blue

2 - CVI II ADAPTOR

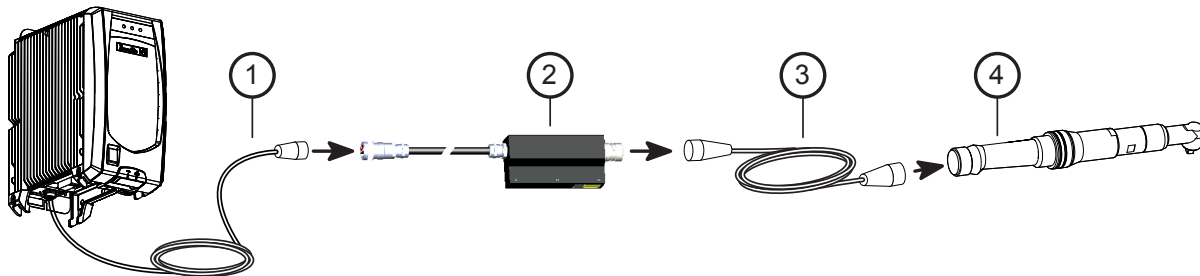

Switch off the controller before disconnecting the tool cable

Legend

- 1 CVI3 extension cable (optional)
- 2 CVI II adaptor
- 3 CVI II cable
- 4 CVI II tool

3 - RS232 - SubD 9pt

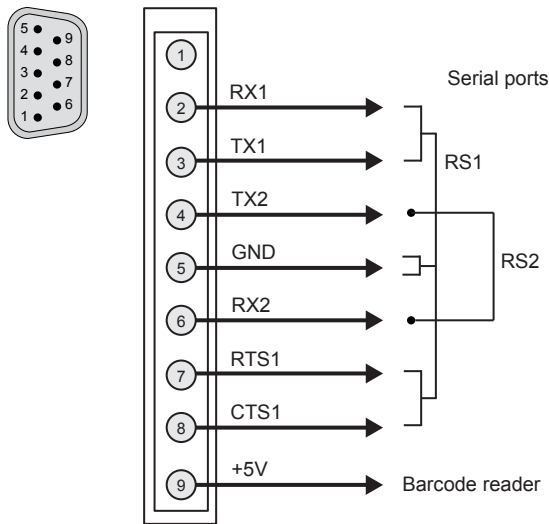

5 - DIGITAL OUTPUTS (0 – 24V)

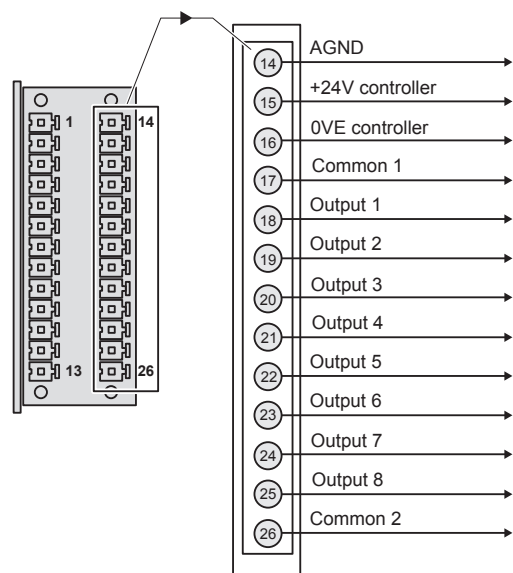

4 - DIGITAL INPUTS (0 – 24V)

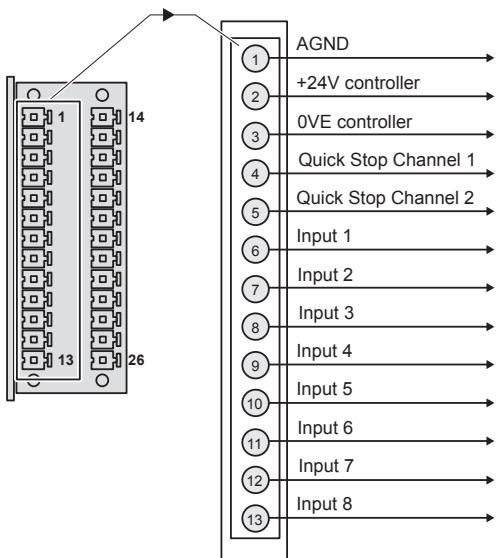

Example of connections:

Possibility to connect a 24V external supply in parallel of the 24V delivered by the controller:

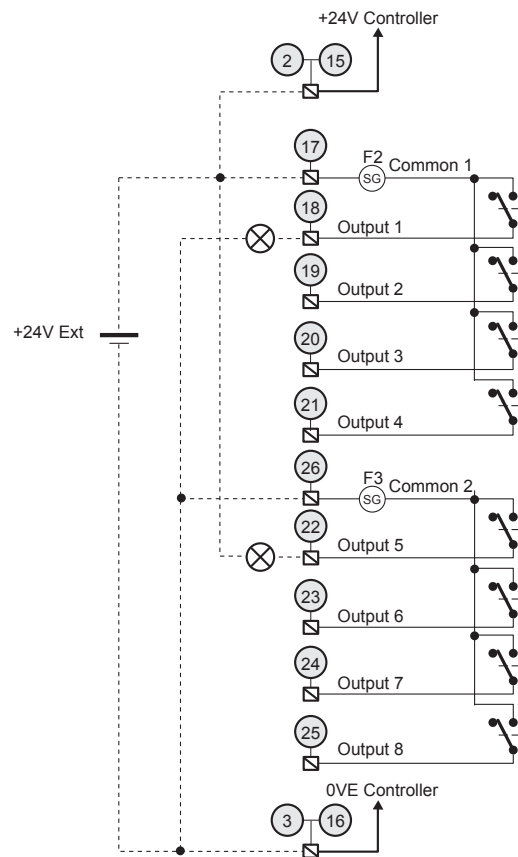

Example of connections:

Possibility to connect a 24V external supply in parallel of the 24V delivered by the controller:

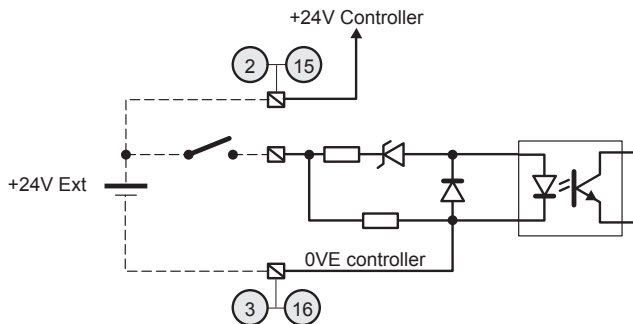

6 - Tightening flow chart and timing chart

Input/Output defined by default can be used to control tightening operation from a PLC or other electronic device. Here is an example of standard exchange between a CVI3 controller and a PLC.

6.1 - Tightening operation through IO flow-chart

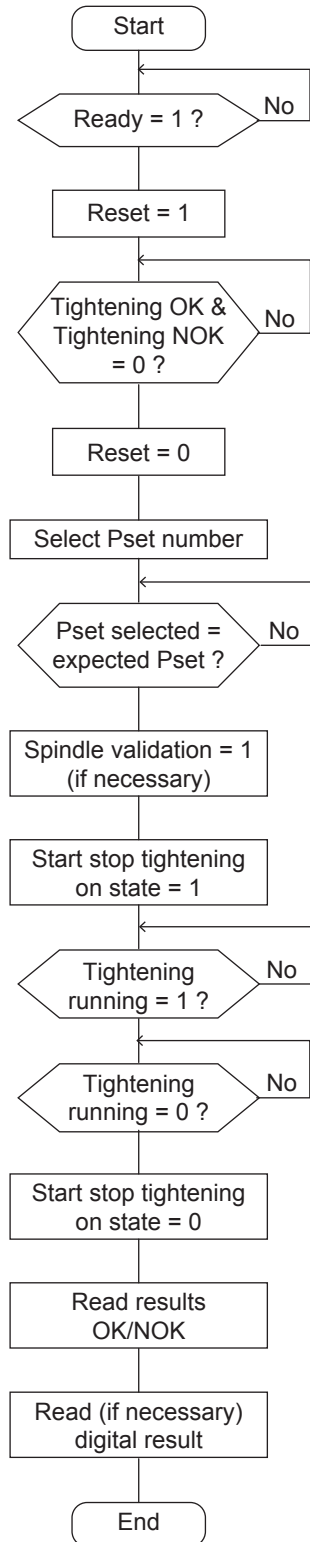

6.2 - Tightening operation through IO timing chart

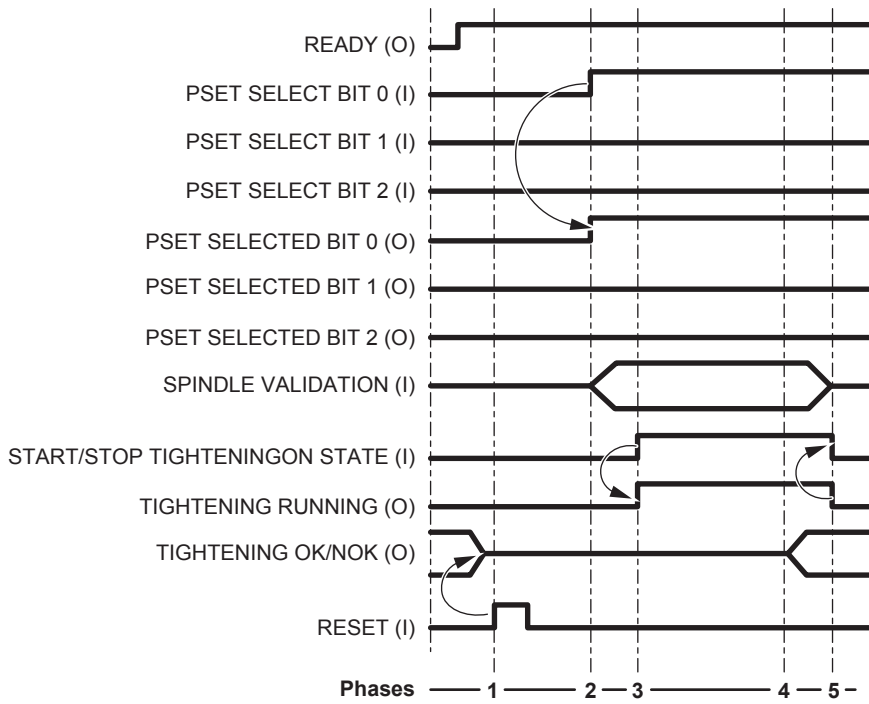

Phase	Designation
1	The "Reset" signal is sent by the PLC. This leads to reset the report ("Tightening OK/NOK").
2	The controller receives the Pset no.1 selection. The command is acknowledged by the "Pset Selected" signals.
3	The controller detects the "Start Stop Tightening On State" signal transition. The tightening operation starts and "Tightening Running" signal is set to 1.
4	At the end of the tightening operation, the controller sets "Tightening OK" or "Tightening NOK" signals.
5	The "Tightening Running" signals returns to zero when all operations are over.

7 - SYNCHRONIZING SINGLE-CHANNEL CONTROLLERS

It is necessary to wire a diode 1N4148 in serial with each synchro out signal.

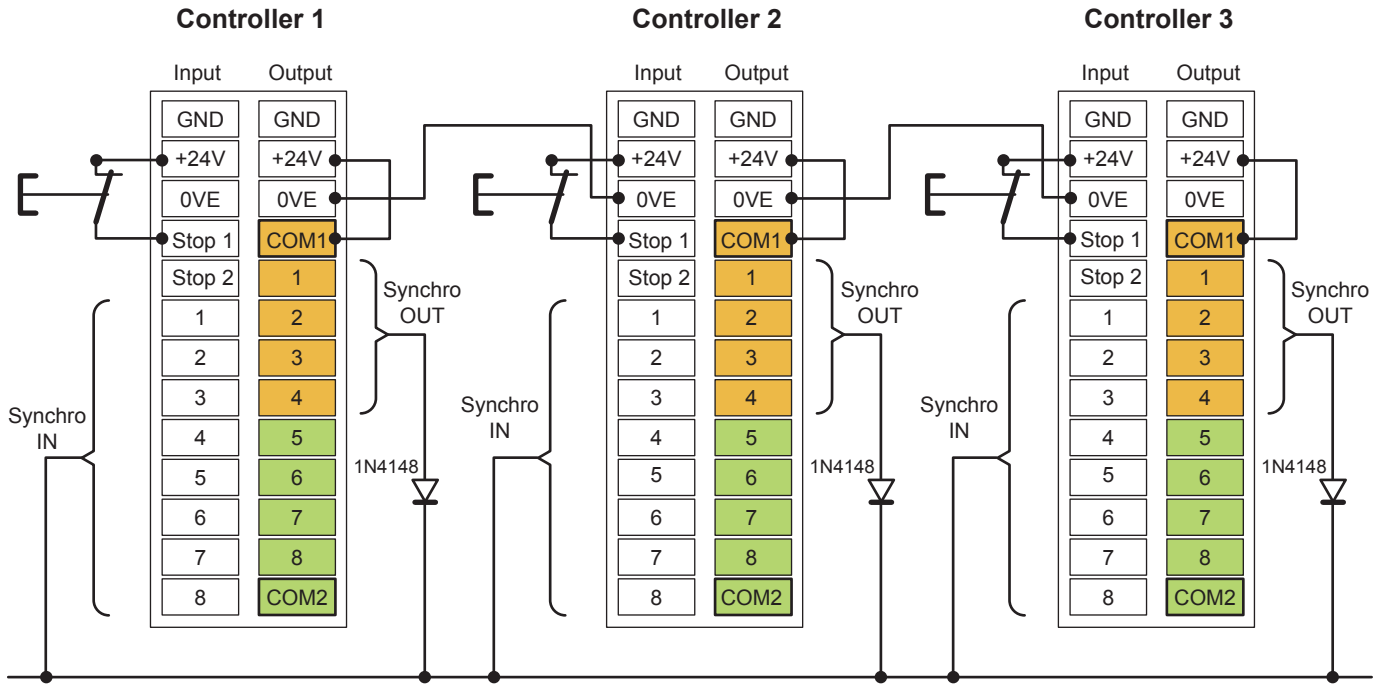

8 - SYNCHRONIZING TWINCVI3 CONTROLLERS

It is necessary to wire a diode 1N4148 in serial with each synchro out signal.

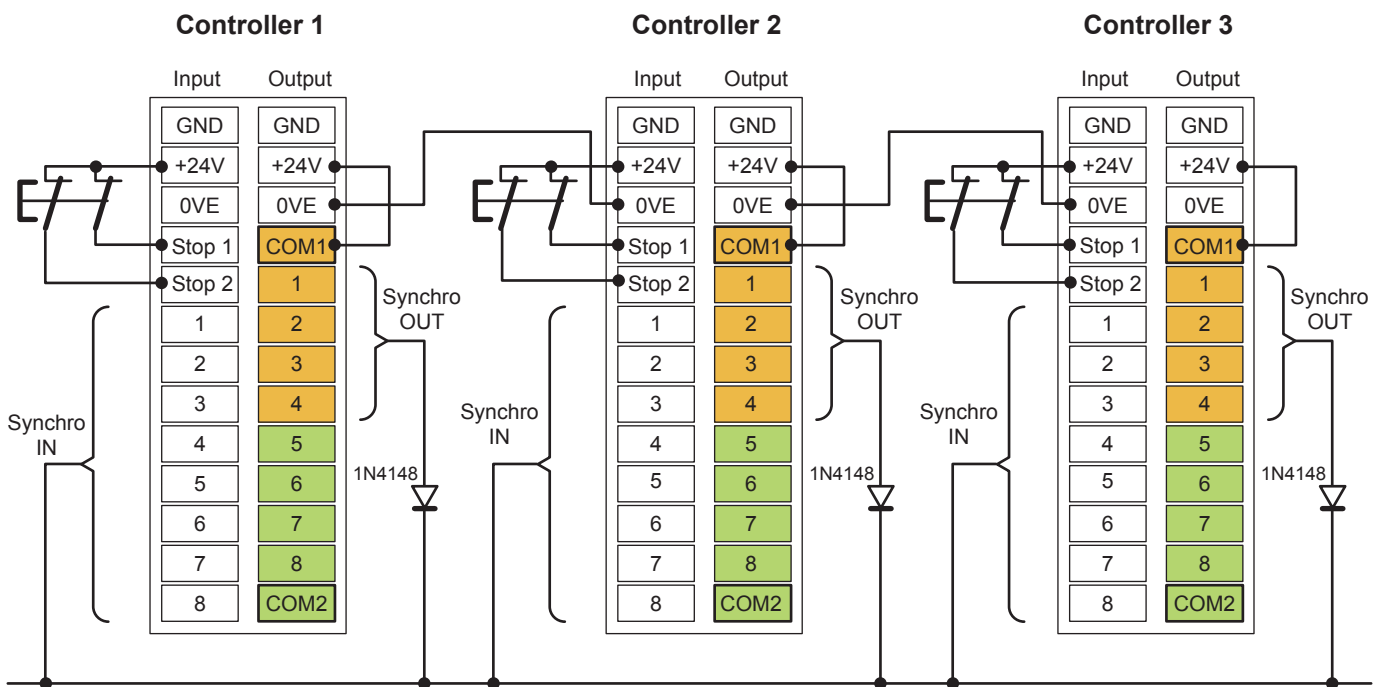

9 - eBUS (for accessories)

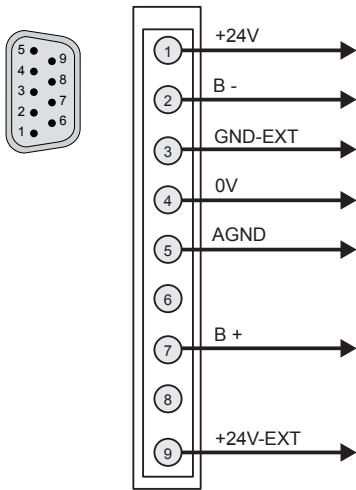

10 - WORKGROUP

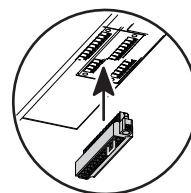
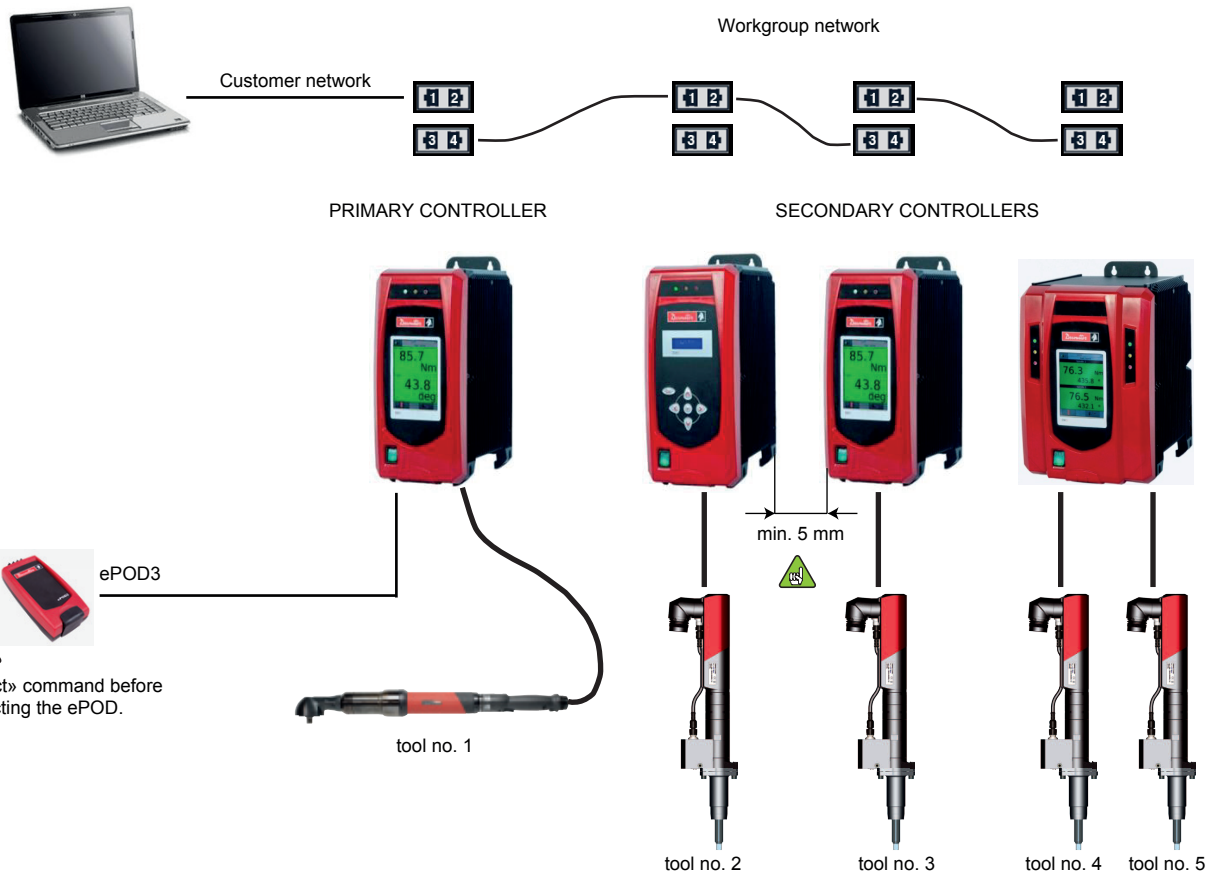

For each secondary controller, check that the quick stop is on but inactive

APPENDIX - SPARE PARTS - CVI3 VISION

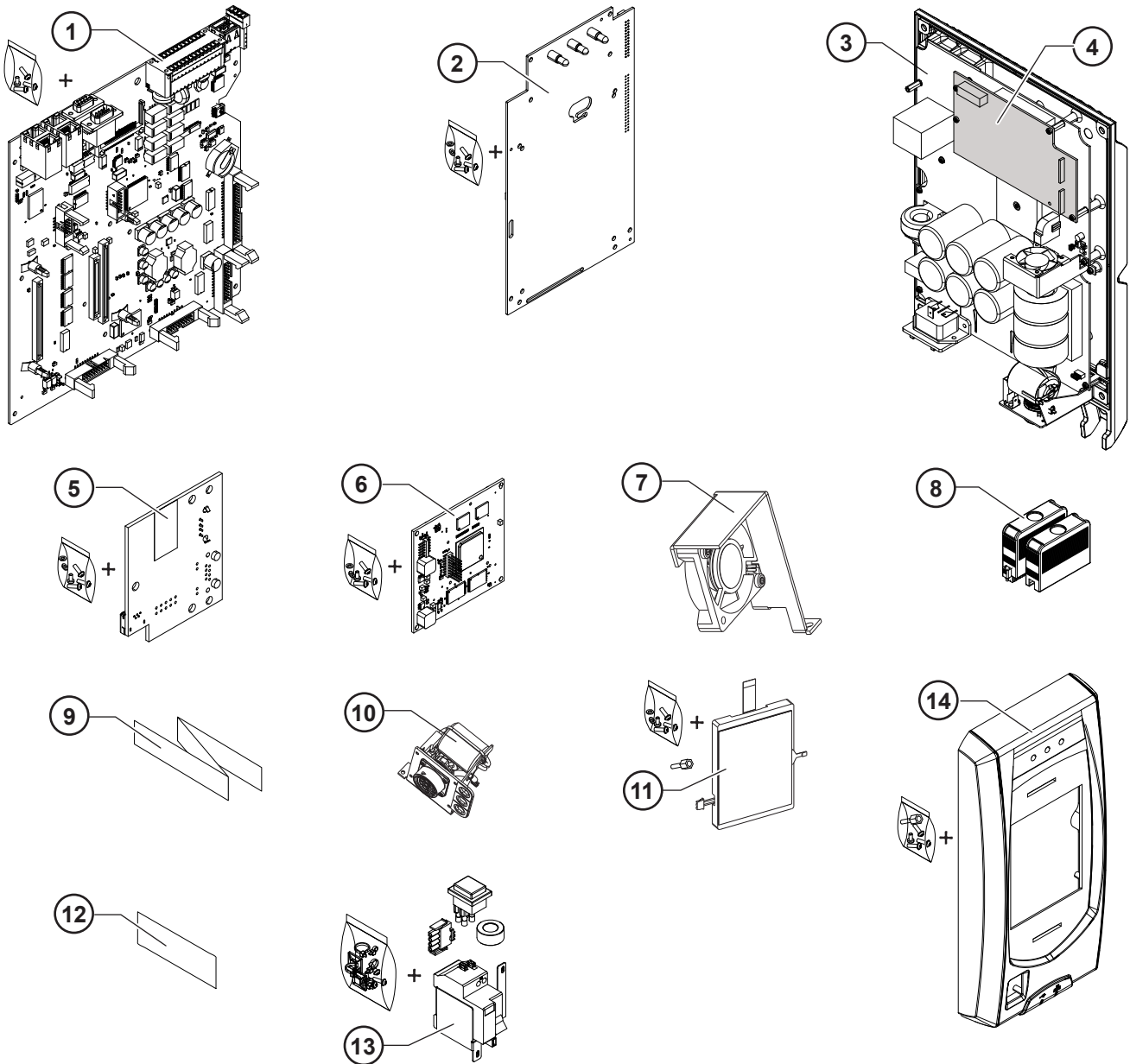

Item	Designation	Part number
1	Interface board including screws	6159188835
2	Display board without display and screws	6159188535
3	Complete drive board on the heatsink	6153972145
4	TPLC board	6159188985
5	Ethernet board including screws	6159188825
6	CPU board including screws	6159188895
7	Drive board fan	-
8	I/O connector kit	6159285025
9	Flat cable for Interface board / Drive board connection	6159285065
10	Tool connector kit	-
11	Display including screws	6159235285
12	Warning label	6158715620
13	Earth fault circuit breaker including GFI switch, wiring kit and screws	6159159865
14	Front panel including screws	6155731435

APPENDIX A - CONTROLLER POWER CONSUMPTION: CURRENT INLET

The "Power triangle"

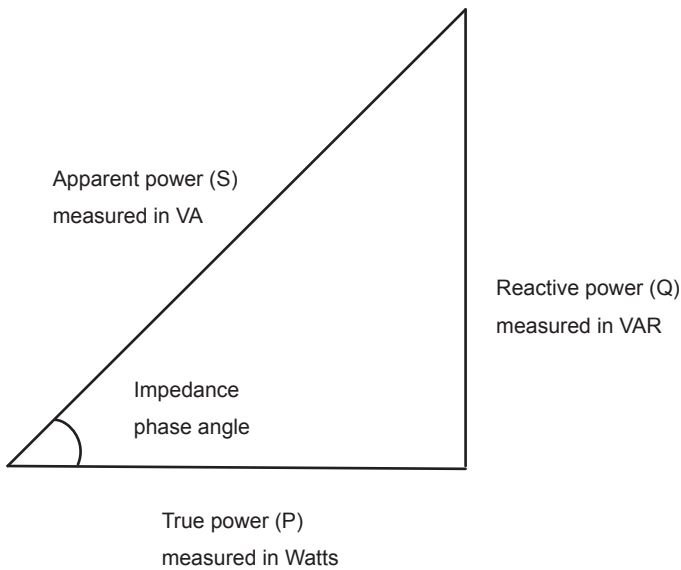

P = true power $P = \frac{1}{T} \int_0^T u(t) \times i(t) dt$ measured in units of Watts

where T is the period of the signal

On a CVI3, the Power peak is 5kW.

To dimension an installation, the apparent power consumption is the only needed information.

S = apparent power

$$S = U_{rms} \times I_{rms}$$

measured in Volt-Amps (VA)

The apparent power peak is 6kVA the duration of the peak is < 0.5 s

The mean apparent power is always ≤ 1 kVA.

SINGLE PHASE 230 V

At 230 V

$$\rightarrow I_{rms} \times \frac{230}{\sqrt{2}} \leq 1 \text{ kVA}$$

$$\rightarrow I_{rms} \leq 1000 \times \frac{\sqrt{2}}{230} \text{ A}$$

$$\rightarrow I_{rms} \leq 6.15 \text{ A}$$

Then we recommend to use a circuit breaker 10A Curve D.

At 110 V

$$\rightarrow I_{rms} \times \frac{110}{\sqrt{2}} \leq 1 \text{ kVA}$$

$$\rightarrow I_{rms} \leq 1000 \times \frac{\sqrt{2}}{110} \text{ A}$$

$$\rightarrow I_{rms} \leq 12.85 \text{ A}$$

Then we recommend to use a circuit breaker 20A Curve D.

APPENDIX B - JVL6-32 RESIDUAL CURRENT CIRCUIT BREAKER

The CVI3 has a JVL6-32 residual current circuit breaker with over-current Protection.

The residual current circuit breaker must be tested monthly.

It provides protection against earth leakage faults (30mA), overloads, short-circuits and Over-current in your installation (I=16A. see curve).

The Over-current protection of the JVL6-32 uses “D” tripping characteristics



FIGURE 1 – CURVE C AND D

APPENDIX - ePOD

The ePOD unlocks a specified level of functionality and acts as a back-up unit for the configuration of the CVI3 controllers. It also increases the number of results, curves and logs in the controller.

There are different models of ePOD and specific ePOD designed for some specific protocols.

Model	ePOD1	ePOD2	ePOD3	ePOD2C	ePOD3C	ePOD4C
Part number	6159360750	6159360760	6159360770	6159363110	6159363180	6159363120
Backup						
Complete backup of the controller system	included	included	included	included	included	included
Results storage						
Number of Pset results	10,000	20,000	20,000	20,000	20,000	20,000
Number of curves per tool	20	50	50	50	50	50
Number of Pset versions per Pset	10	20	20	20	20	20
Number of events in the event log	500	1,000	1,000	1,000	1,000	1,000
Basic functions						
Number of steps per Pset:						
- Tools with cable connection	15	15	40	15	15	40
- Wireless battery tools	10	10	10	10	10	10
CVILOGIX	-	included	included	included	included	included
Workgroup	-	-	included	-	-	included
Programming / Supervision / Controller backup						
Results storage	-	included	included	included	included	included

Tightening units management (with CVI3 Vision controller only)						
Maximum number of tightening units	2	2	2	3	3	4
Maximum number of wireless battery tools	1	1	1	2	3	4

ePOD1

ePOD1 is a backup module for the controller result and configuration database.

- It can be used as real time backup module. In this case the ePOD1 must always be plugged to the controller.
- It also can be used as a manual backup that stores the configuration database, the results database and the firmware version of the controller. ePOD1 gets a snapshot of the controller.

ePOD2

ePOD2 has all functionalities of ePOD1.

- ePOD2 activates CVILOGIX (Embedded PLC of CVI3 controllers).

ePOD3

ePOD3 has all functionalities of ePOD2.

- ePOD3 activates the workgroup configuration.

ePODxC

ePODxC has all functionalities of ePOD2 or ePOD3.

- It can be connected to CVI3 Vision controllers only.

More Than Productivity