



Dispositivi lampeggianti *Signalling devices*



050



La realizzazione di un prodotto ad alto contenuto tecnologico non può fare solamente affidamento alla creatività progettuale o all'ottimizzazione dei costi, ma, se vuole entrare in una logica di mercato evoluto, deve rispettare alcune fondamentali richieste di una società sempre più sofisticata: • attento adempimento della legislazione vigente; • ottimizzazione dei processi produttivi e logistici • rispetto ambientale e risparmio energetico.

La New Elfin, che opera da anni nel settore dei componenti per l'automazione, ha progettato e costruito un nuovo sistema modulare per l'illuminazione e la segnalazione di sicurezza di apparecchiature elettriche. La progettazione di questo nuovo sistema di sicurezza è partita da una attenta lettura delle recenti disposizioni europee; dalla direttiva macchine 89/392 CEE e successive integrazioni, recepita dal D.P.R. 24 - 7 - 96 n° 459, dalle legislazioni vigenti D.P.R. 547/55, D. Lgs 626/94, D. Lgs 242/96, che evidenziano alcuni parametri fondamentali da rispettare.

Qui di seguito tenteremo di indicare i principali obiettivi da raggiungere.

A high tech product cannot be created simply by relying on inspired design or optimisation of costs but must meet certain basic requirements of an ever more sophisticated and demanding society if it is to secure a place on a highly developed market: • *unswerving compliance with current legislation* • *optimisation of production and logistic processes* • *low environmental impact and energy saving*

Drawing on its long-term experience in the automation components sector, New Elfin has designed and constructed a new modular system for lighting and safety signalling of electric equipment.

This new safety system has been designed paying particular attention to recent European regulations taken from Machinery Directive 89/392/EEC and subsequent amendments, enacted by Presidential Decree No. 459 of July 24 1996, from current legislation Presidential Decree 547/55, Decree Law 626/94, Decree Law 242/96 which specify certain important parameters that must be complied with.

Below, we will try to establish the main objectives to be achieved.

VOLONTARIETA' ALLE NORME / VOLUNTARY COMPLIANCE WITH REGULATIONS

La conformità alle norme non è obbligatoria, bensì volontaria, ciò non di meno chi segue le indicazioni e le prescrizioni normative gode di una presunzione di conformità ai requisiti essenziali di sicurezza, garantendo al prodotto i requisiti necessari per soddisfare le richieste di un mercato moderno. Nel caso dei dispositivi di illuminazione e segnalazione di sicurezza è utile ricordare che si opera nell'ambito delle barriere di sicurezza passiva che, al contrario di quelle attive, hanno il compito di interpretare, segnalare, monitorare e prevenire eventuali situazioni di pericolo.

Compliance with regulations is not mandatory but voluntary. Nonetheless, it is assumed that whoever follows the indications and normative prescriptions complies with essential safety requirements, guaranteeing that the product has the necessary prerequisites to measure up to the demands of a modern market. In the case of safety lighting and signalling devices, it is worth remembering that passive safety barriers are used which, as opposed to active safety barriers, must be able to interpret, highlight, monitor and prevent hazardous situations.

TIPI DI BARRIERE / TYPES OF BARRIERS	barriera di inaccessibilità <i>barrier restricting access</i>	carter, ripari mobili, armadi, distanziamento <i>covers, movable guards, segregation cabinets</i>	APPLICAZIONI / APPLICATIONS
	barriera di contenimento <i>containment barrier</i>	serbatoio, tubazione, condotto a tenuta <i>tank, pipe, sealed duct</i>	
	barriera di limitazione danno <i>damage restriction barrier</i>	comando di arresto d'emergenza <i>emergency stop control</i>	
	barriera di riduzione della dose <i>dose reduction barrier</i>	aspiratori gas e fumi, protettori, auricolari, insonorizzazione / <i>gas and fume extractors, ear protectors, sound-proofing</i>	
	barriera comportamentale <i>behaviour type barrier</i>	informazione e formazione del personale <i>information and personnel training</i>	
	barriera di avviso <i>warning barrier</i>	segnaletica di sicurezza <i>safety signalling</i>	
	barriera di allarme <i>alarm barrier</i>	sistemi automatici di allarme e preallarme <i>automatic alarm and pre-alarm systems</i>	
	barriera preventiva <i>preventive barrier</i>	procedure di manutenzione preventiva e/o su condizione / <i>preventive and/or on condi- tion type maintenance procedures</i>	



INTERFACCIA UOMO - MACCHINA / MAN- MACHINE INTERFACE

Ogni operatore umano, nel momento in cui la macchina è destinata ad essere utilizzata anche da lui, ha l'esigenza ed il diritto di trovarsi nelle migliori condizioni, ad esempio, interfacce trasparenti (vale a dire interpretabili facilmente ed inequivocabilmente), istruzioni esaurienti per ogni operazione (messa a punto, conduzione, manutenzione, pulizia ecc.), principi ergonomici (buona luminosità, comfort, comandi e meccanismi accessibili, ecc.). Con il termine generico di operatore la Direttiva Macchine e le Norme Tecniche identificano un insieme di persone con differenti livelli di cultura, preparazione e modo di approcciarsi alla macchina.⁽¹⁾

At the moment in which he prepares to use the machine, the operator needs and has the right to be in the best conditions which implies, for example, transparent interfaces (i.e. easy to understand and unambiguous), complete instructions for each operation (setting, operation, maintenance, cleaning, etc.), compliance with human engineering principles (good lighting, comfort, accessible controls and mechanisms, etc.). The Machinery Directive and Technical Regulations establish that the general term "operator" means a set of people with different levels of culture, knowledge and method of approaching the machine⁽¹⁾.



FATTORI DI RISCHIO - PRECAUZIONI SUPPLEMENTARI / FACTORS OF RISK - ADDITIONAL PRECAUTIONS

Ogni costruttore certifica il raggiungimento di tutti i livelli di sicurezza a progetto finito, cioè quando la macchina è pronta per la vendita, dopo un attento assemblaggio e un collaudo severo. Occorre ricordare, però, che durante queste fasi, per motivi contingenti di industrializzazioni, non tutti i dispositivi di sicurezza sono operativi, esponendo gli operatori a imprevedibili fattori di rischio.

Each manufacturer certifies that all levels of safety have been achieved at the end of the project, i.e. when the machine is ready to be sold after attentive assembly and searching inspection. It must be remembered however that, for unavoidable reasons of industrialisation, not all the safety devices are working in these phases and the operators are therefore exposed to unforeseeable factors of risk.

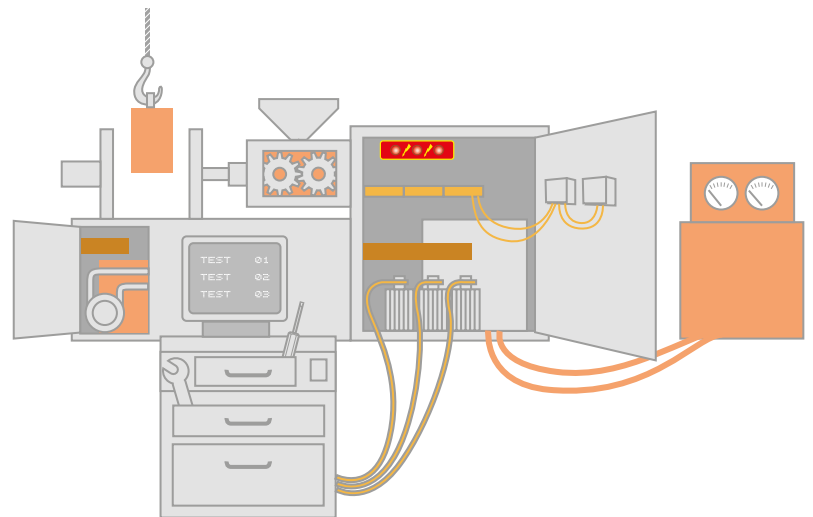

FATTORI DI RISCHIO ESPOSIZIONE AL PERICOLO / FACTORS OF RISK EXPOSURE TO HAZARD

L'esposizione al pericolo è in funzione del tempo durante il quale una persona rimane appunto esposta alla possibilità di un coinvolgimento da parte della fonte di pericolo, oppure è in funzione della frequenza con cui la persona accede alla zona pericolosa della macchina. In ogni caso, esiste una motivazione in ragione della quale l'esposizione si verifica. Questa motivazione può dipendere dal metodo di lavorazione della macchina, oppure dalla necessità d'effettuare interventi di messa a punto e manutenzione.

Exposure to hazard depends on the time during which a person remains exposed to the possibility of being involved in a source of hazard or according to the frequency with which the person accesses the machine danger zone. In each case, there is a reason why this exposure occurs which may depend on the method of operation of the machine or on the need for setting and maintenance.

1) Allegato I (Articolo 1.1.1. comma 3) Direttiva Macchine.
Articolo 3.21 Norma UNI EN 292-1
1) Annex 1 (Article 1.1.1. Section 3) Machinery Directive
Article 3.21 UNI EN 292-1



MANOMISSIBILITÀ DEI DISPOSITIVI DI SICUREZZA THE POSSIBILITY OF TAMPERING WITH SAFETY DEVICES

Su ogni macchina esiste anche il rischio che i dispositivi di sicurezza possano venire manomessi o addirittura asportati. Nel panorama delle ragioni, nessuna “scusabile”, emergono difetti di progettazione o di costruzione della macchina; errori nella scelta della macchina (non adatta a svolgere le lavorazioni per le quali era stata acquistata), adattamenti impropri da parte dell'utente, abitudini sconsiderate invalse fra gli operatori e gravi dimenticanze in fase manutentiva.

On any machine, there is also the risk that the safety devices may be defeated or even removed. The reasons for these actions (none of which can be excused) include machine design and construction defects; errors in selecting the machine (not suitable for the processes for which it has been acquired); improper adaptations by the user; bad habits that are ingrained in operators and serious shortcomings in the maintenance phase.

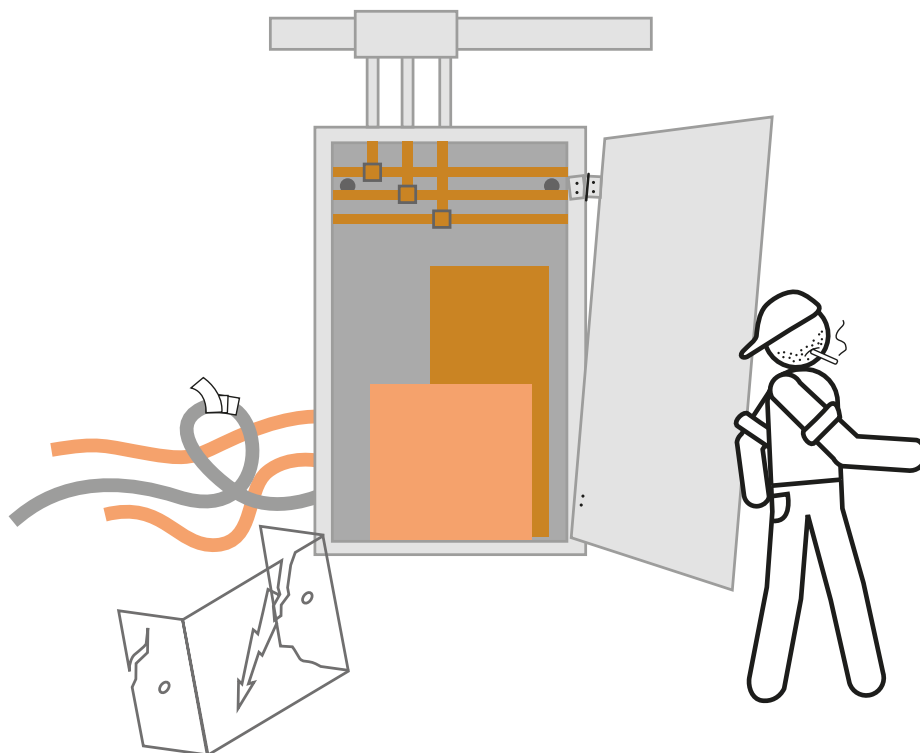

MOTIVAZIONI CHE PORTANO ALLA MANOMISSIONE
DEI DISPOSITIVI DI SICUREZZA
REASONS WHY SAFETY DEVICES ARE TAMPERED WITH / ADDITIO-
NAL PRECAUTIONS IN EMERGENCIES

interferenza marcata fra i dispositivi di sicurezza e lo svolgimento del normale ciclo produttivo / *evident interference between safety devices and running of the normal production cycle*

guasti frequenti sui dispositivi di sicurezza che producono indisponibilità o difficoltà di impiego della macchina / *frequent failure of safety devices that results in unavailability or difficulty in using the machine*

difficoltà di messa a punto della macchina per impossibilità di accesso alle parti mobili / *difficulty in setting the machine due to inaccessibility of mobile parts*

impiego della macchina difforme da quello previsto dal costruttore
use of the machine other than that intended by the manufacturer

modifiche apportate sulla macchina che ne hanno reso impossibile l'impiego con dispositivi di sicurezza attivi / *modifications to the machine that have made it impossible to use this with the safety devices working*

comportamento sconsiderato degli operatori addetti alla macchina
irresponsible behaviour of the machine operator

mancato ripristino dei dispositivi di sicurezza dopo un intervento manutentivo che ne ha richiesto l'esclusione o l'asportazione / *failure to reset the safety devices after maintenance operations involving bypassing or removal of these*



PRECAUZIONI SUPPLEMENTARI IN CASO DI EMERGENZA
ADDITIONAL PRECAUTIONS IN EMERGENCIES

agevolazioni manutentive in termini di: • accessibilità alle parti interne • facilità di movimentazione in base alle capacità umane • scelta adeguata dei posti di lavoro • limitazione del numero degli utensili e delle attrezzature speciali • facilità di sorveglianza

facilitate maintenance as regards: • accessibility to inside parts • ease of movement according to human capacity • appropriate selection of working positions • restriction of the number of tools and of special equipment • ease of supervision

isolamento delle fonti di energia e dissipazione dell'energia immagazzinata: • isolando la macchina da qualsiasi fonte d'energia o da altri servizi; l'isolamento deve essere visibile (interruzione visibile delle continuità dell'alimentazione di energia) o garantito attraverso il controllo della posizione dell'organo di comando dell'apparecchio d'isolamento e deve essere chiaro quali zone della macchina sono state isolate • bloccando se necessario (per esempio, su grandi macchine o impianti), gli apparecchi d'isolamento nella posizione di circuito "isolato" • adottando misure per garantire, a valle dei punti d'isolamento, quali: - l'assenza di energia potenziale - l'assenza di energia cinetica • verificando il risultato delle misure mediante un sistema sicuro di lavoro

isolation of energy sources and dissipation of energy stored: • isolating the machine from all sources of energy and from other services; the isolation must be visible (visible interruption of continuity of energy supply) or guaranteed through control of the position of the control device of the isolator with clear indication of which areas of the machine have been isolated • locking if necessary (e.g. on large machines or installations, isolators in the circuit "isolated" position) • taking steps to guarantee, downstream of the isolation points: - absence of potential energy - absence of kinetic energy • checking the effects of the measures applied through a safe working procedure

adozione di accorgimenti che rendano sicura la movimentazione della macchina e delle sue parti pesanti quali:

- organi normalizzati di sollevamento con brache, ganci, golfari o fori filettati per il fissaggio di tali organi - organi che consentono la presa automatica per mezzo di un gancio di sollevamento, quando il punto d'aggancio non è accessibile da terra - sedi di forcolamento per le macchine che devono essere trasportate con un carrello a forche - indicazioni sulla macchina, o su alcune delle sue parti che possono essere rimosse, del valore della loro massa espresso in chilogrammi - apparecchi di sollevamento ed attrezzi integrati nella macchina

application of measures that ensure safe handling of the machine and of heavy parts of this such as: - use of standard attachments for lifting gear with slings, hooks, eyebolts or threaded holes for fastening of these attachments - lifting gear that permits automatic attachment using a lifting hook when the attachment point is not accessible from the ground - fork insertion compartments for machines that must be transported using fork-lift trucks - indication on the machine or on some of its parts that cannot be removed of their weight in kilograms - lifting gear and equipment integrated in the machine

accorgimenti destinati a rendere sicuro l'accesso per la messa a punto e la manutenzione (piattaforme, scale antiscivolo, corrimani, ecc.) / *measures intended to guarantee safe access for setting and maintenance (platforms, non-slip ladders, handrails, etc.)a*

sistemi di autodiagnosi o comunque di assistenza per l'individuazione dei guasti e del pericolo
self-test systems or assistance in locating faults and hazards

misure atte a garantire la stabilità statica e dinamica della macchina
measures intended to guarantee static and dynamic stability of the machine

L'installazione del Dispositivo di Sicurezza Lampeggiante permette di prevenire eventuali incidenti avvertendo, con il lampeggiamento, l'operatore della presenza di tensione nell'impianto elettrico. I dispositivi lampeggianti DSL vengono installati in posizione estremamente visibile all'apertura delle ante del quadro elettrico, e collegati direttamente a valle dell'interruttore principale. Il lampeggiare delle tre lampade rosse mette in evidenza la condizione di pericolo per la presenza di tensione. I dispositivi DSL sono idonei al collegamento sia a linee trifasi con o senza neutro, che a linee monofasi. La realizzazione a tre lampade rosse lampeggianti e la simbologia a saetta gialla su fondo rosso rendono il messaggio evidente e comprensibile al di là delle barriere linguistiche o culturali.

Installation of the Flashing Safety Device makes it possible to prevent accidents by alerting the operator, with the flashing, that the electrical system is live. DSL flashing safety devices are installed in a position where they are immediately visible on opening the door of the cabinet and are connected directly downstream of the main circuit breaker. Flashing of the three red lights highlights the power on hazard condition. The DSL devices are suitable for connection to three-phase lines with or without neutral and to single-phase lines. Use of three red flashing lights and the yellow lightning symbol on a red background ensure that the message is conveyed immediately and is readily understood, thus overcoming possible linguistic or cultural barriers.

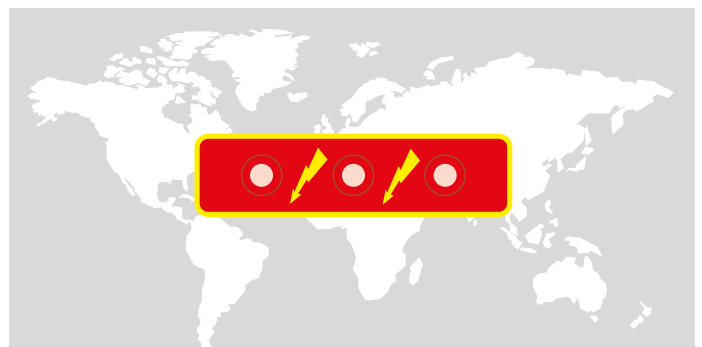

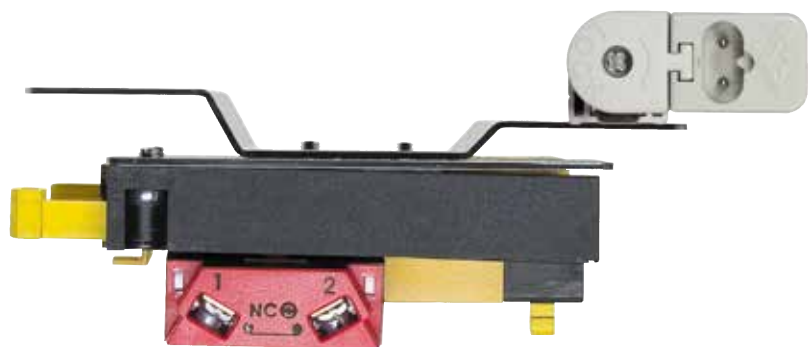

Un sistema flessibile e modulabile...
A flexible modular system...



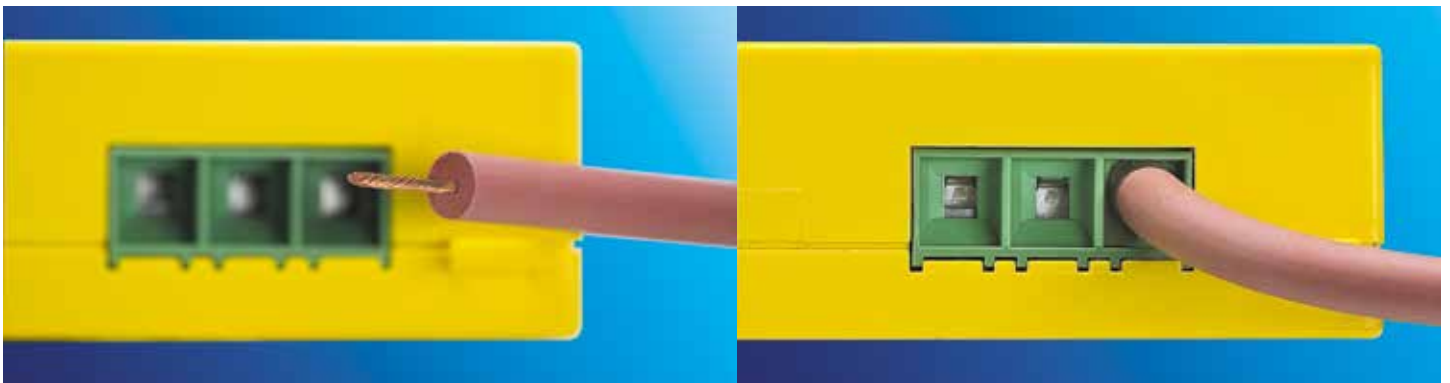

050

easy mounting

Tutti i prodotti adottano sistemi di fissaggio rapido
All products adopt a fasteners system for a fast mounting

L'installazione degli apparecchi e delle plafoniere sui quadri elettrici, è realizzabile tramite speciali viti \varnothing 5,5 mm autoformanti. L'applicazione delle plafoniere sugli apparecchi è possibile tramite viti automaschianti M4. Le viti sono state realizzate con speciali teste che permettono una facile avvitatura in posizioni di montaggio difficili. Sia gli apparecchi che le staffe accessorie vengono forniti con viti incluse.

The installation of devices and ceiling lights on electric panels is possible thanks to special selfbaking screws \varnothing 5,5 mm. The application of ceiling lights on devices is possible through selfthreading M4 screws. All the screws were made with special heads that permit an easy screwing in difficult mounting positions. Devices and brackets are supplied with screws included.

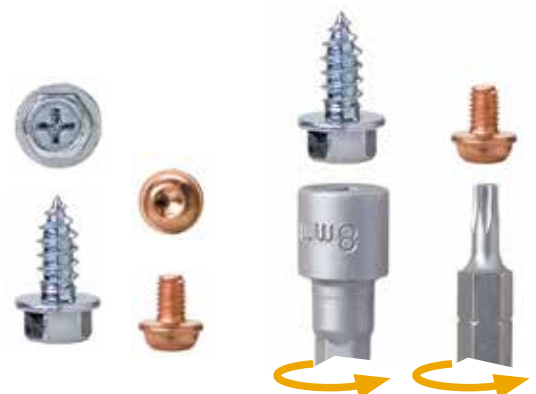



Layout componibilità / Application layout

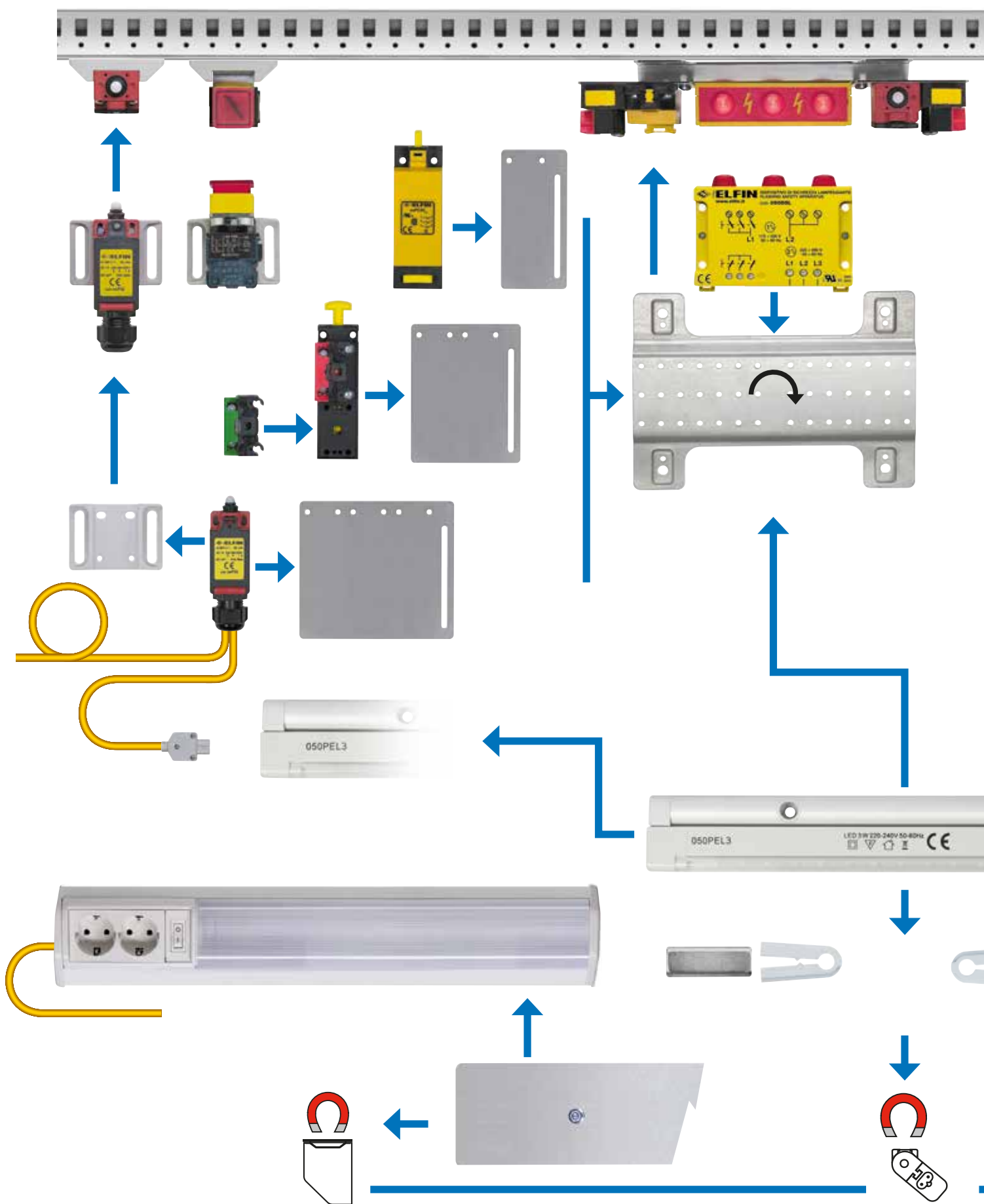

050

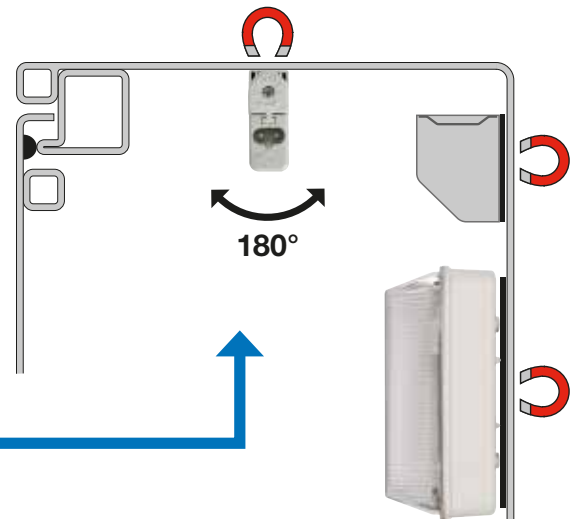
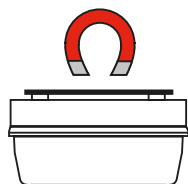
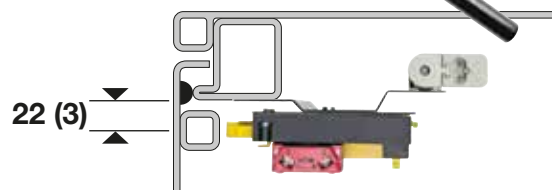
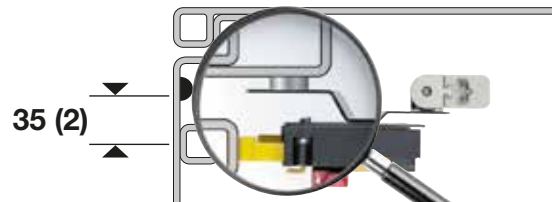
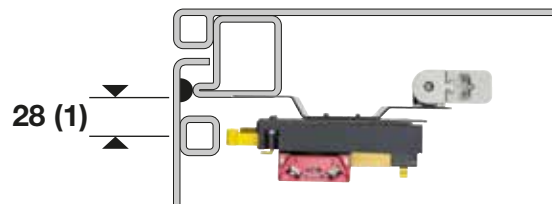
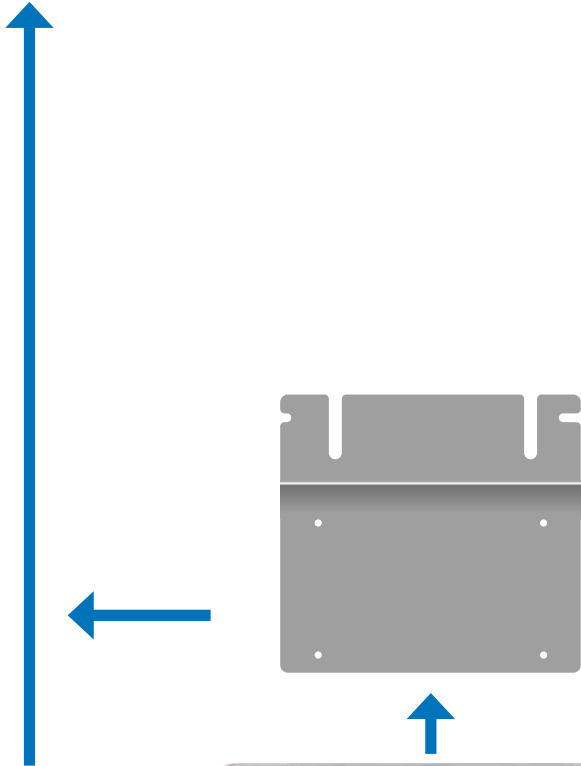
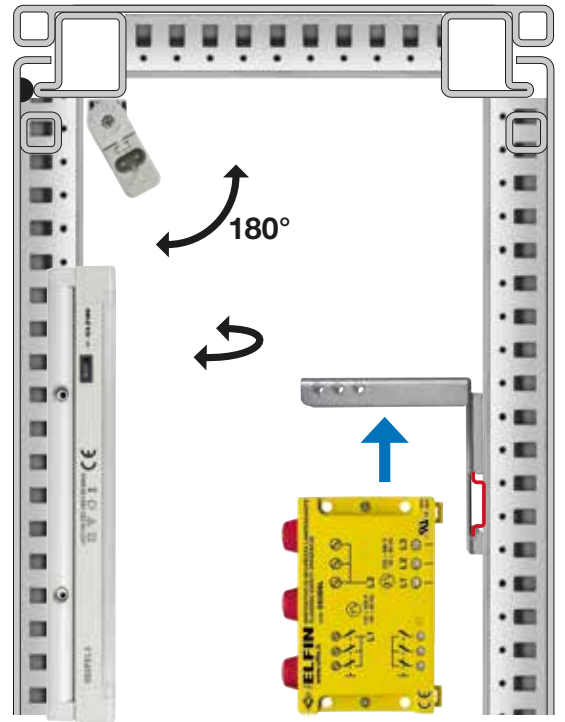

050



APPARECCHI DI SEGNALAZIONE LAMPEGGIANTE *easy mounting* FLASHING SIGNALLING DEVICES *easy mounting*

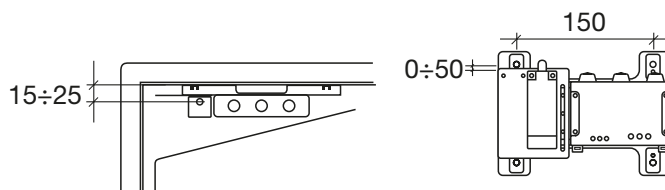

gr.	Tensione di alimentazione/power supply voltage	Configurazione/ configuration
385	$\textcircled{3V}$ 220÷690 V. 50÷60 Hz $\textcircled{1V}$ 110÷400 V. 50÷60 Hz	con finecorsa / with limit switch ⁽¹⁾ 050ASL

APPARECCHI DI SEGNALAZIONE LAMPEGGIANTE CON FINECORSA D'INTERBLOCCO⁽⁴⁾ *easy mounting* FLASHING SIGNALLING DEVICES WITH INTERLOCK LIMIT SWITCH⁽⁴⁾ *easy mounting*

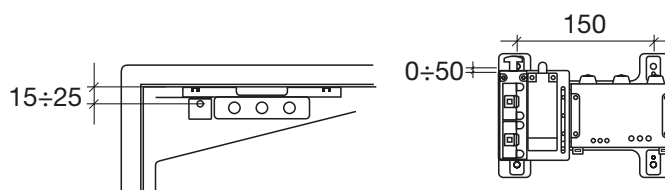
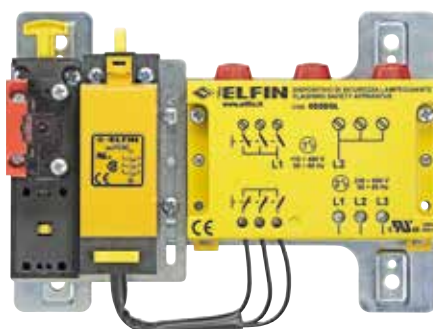

gr.	Tensione di alimentazione/power supply voltage	Configurazione/ configuration
535	$\textcircled{3V}$ 220÷690 V. 50÷60 Hz $\textcircled{1V}$ 110÷400 V. 50÷60 Hz	interblocco / interlock 1NC ⁽²⁾ 050ASLFI01 interblocco / interlock 1NO ⁽³⁾ 050ASLFI10 interblocco / interlock 1NC ⁽²⁾ +2NC ⁽⁴⁾ 050ASLFI03 interblocco / interlock 1NO ⁽³⁾ +2NC ⁽⁴⁾ 050ASLFI12

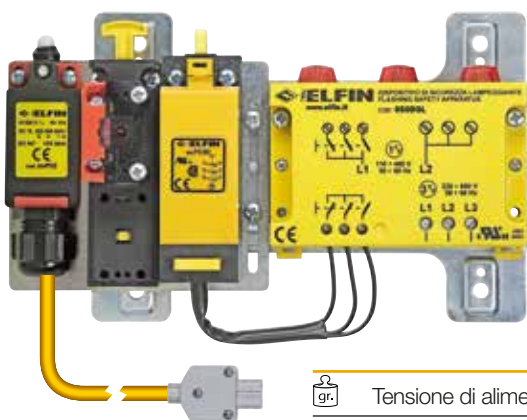

gr.	Tensione di alimentazione/power supply voltage	Configurazione/ configuration
730	$\textcircled{3V}$ 220÷690 V. 50÷60 Hz $\textcircled{1V}$ 110÷400 V. 50÷60 Hz	interblocco / interlock 1NC ⁽²⁾ 050AS01FC interblocco / interlock 1NO ⁽³⁾ 050AS10FC

(1) Finecorsa tripolare cablato al lampeggiante. Determina l'inserimento solo quando le porte dell'armadio sono aperte.
 (2) A lancio di corrente.
 (3) Di minima tensione
 (4) Normalmente utilizzati per l'inserzione dell'illuminazione e per lo spegnimento di ventole o condizionatori.

(1) Three-pole limit switch wired to the flashing device. Switches this on only when the doors of the cabinet are opened.
 (2) With current inrush
 (3) With minimum voltage
 (4) Normally used to switch on lighting and to switch off fans or conditioners

Sistema di illuminazione interno quadro *Lighting system for industrial cabinets*



LE NOSTRE LAMPADE PER ILLUMINAZIONE QUADRI
OUR LAMPS FOR POWER PANELS

Il design da alle lampade una linea compatta e lineare facilitando il posizionamento e il fissaggio.

The design of the lamps and a compact shape facilitate the positioning and fixing.



Le versioni led sono dotate di chips luminosi con dimensioni maggiorate per garantire molta luminosità.
The LED versions are equipped with bigger chips to ensure high brightness.

Mantenendo un basso consumo energetico
Maintaining a low energy consumption.



Le lampade a led e fluorescenti permettono un orientamento della luce fino a 180°.

The LED lamps and fluorescent light allow to an orientation of 180°.

Adottando l'accessorio magnetico il fissaggio della lampada può essere fatto in pochi secondi.

Adopting the magnetic accessory fastening the lamp can be done in few seconds.

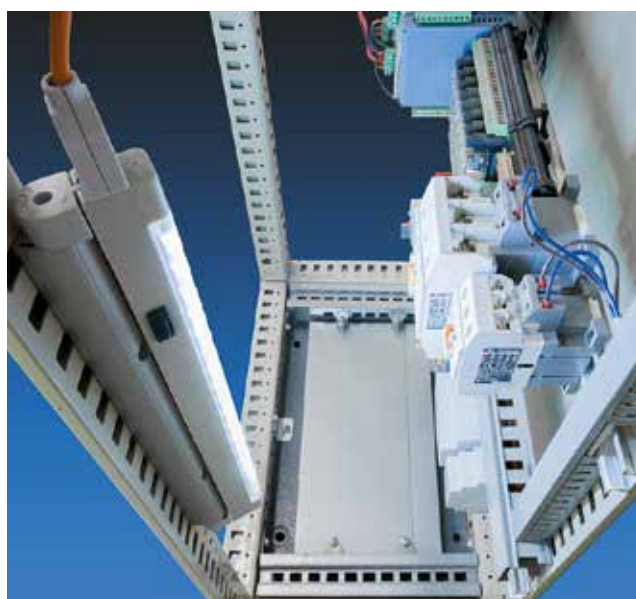



Sistema di illuminazione interno quadro Lighting system for industrial cabinets

PLAFONIERA ELETTRONICA IN VERSIONE LED
LED ELECTRONIC LAMP



LED

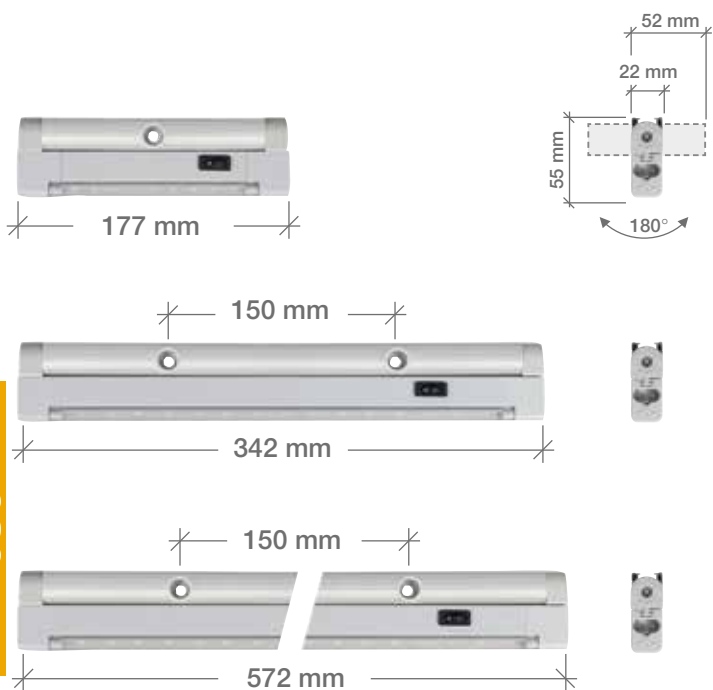

gr.	L	W	24V	110 ÷ 240V
			DC / AC 50 ÷ 60 Hz	AC 50 ÷ 60 Hz
170	550	2,5	050PEL1C-24 ⁽¹⁾	050PEL1C ⁽¹⁾
340	1300	6	050PEL3C-24 ⁽¹⁾	050PEL3C ⁽¹⁾
520	2000	10	050PEL5C-24 ⁽¹⁾	050PEL5C ⁽¹⁾

ACCESSORI / ACCESSORIES



14	Kit per fissaggio magnetico / <i>Magnetic mounting kit</i>	050KFM
----	--	--------



14	Connettore bipolare femmina di alimentazione <i>Female double pole power supply connector</i>	050C7
----	--	-------



14	Connettore bipolare maschio per collegamento in sequenza delle lampade <i>Male double pole connector for sequential lamps wiring</i>	050C7-M
----	---	---------

Sistema di illuminazione interno quadro Lighting system for industrial cabinets



PLAFONIERA ELETTRONICA IN VERSIONE FLUORESCENTE
FLUORESCENT ELECTRONIC LAMP

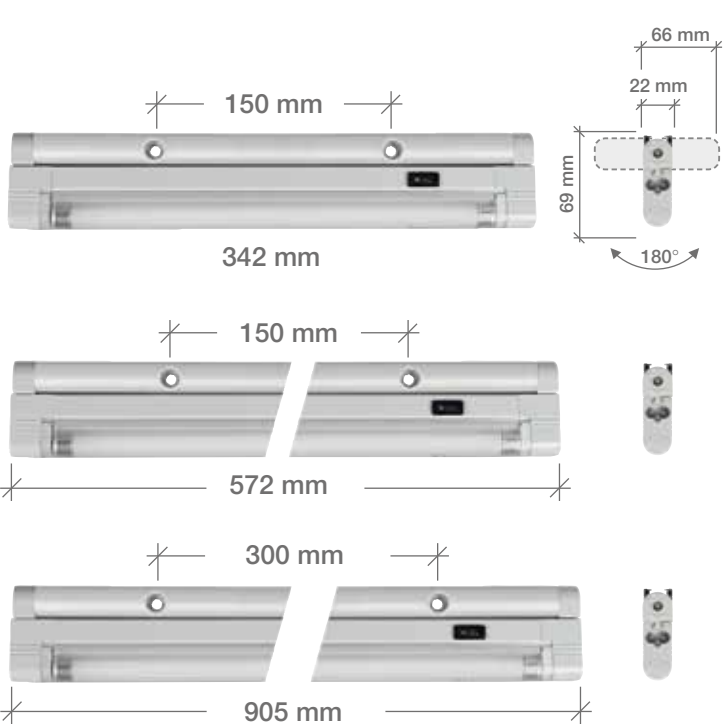

gr.	Light Icon	W	110 ÷ 130V AC / 50 ÷ 60 Hz	220 ÷ 240V AC 50 ÷ 60 Hz
380	400	8	050PE86C ⁽¹⁾⁽²⁾	050PE8C ⁽¹⁾
560	600	13	050PE136C ⁽¹⁾⁽²⁾	050PE13C ⁽¹⁾
860	900	21		050PE21C ⁽¹⁾

050

ACCESSORI / ACCESSORIES

⁽²⁾ Omologazione INTERTEK - ETL per il mercato nordamericano (USA - CND)
INTERTEK - ETL approval for north american market (USA - CND)



14

Kit per fissaggio magnetico / *Magnetic mounting kit*

050KFM



14

Connettore bipolare femmina di alimentazione
Female double pole power supply connector

050C7



14

Connettore bipolare maschio per collegamento in sequenza delle lampade
Male double pole connector for sequential lamps wiring

050C7-M

⁽¹⁾ Connettore 050C7 incluso nella confezione / *050C7 connector included in the box*



Sistema di illuminazione interno quadro Lighting system for industrial cabinets



PLAFONIERA ELETTRONICA CON PRESE / ELECTRONIC CEILING LAMP WITH SOCKETS



gr.	W			
650	8	220/240 50÷60 Hz	050PPE8	
750	13	220/240 50÷60 Hzz	050PPE13	

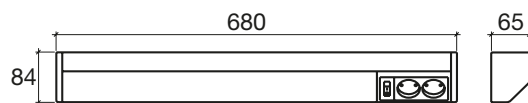
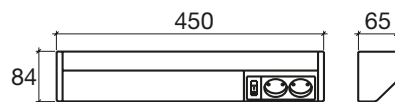

PLAFONIERA PER LAMPADE E27 / CEILING LAMP FOR E27 BULBS



CON STAFFA / WITH BRACKET



gr.	tensione di alimentazione/power supply voltage	
530	250 V 60 W max	050PL60

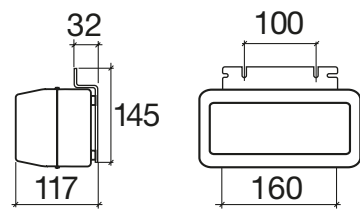
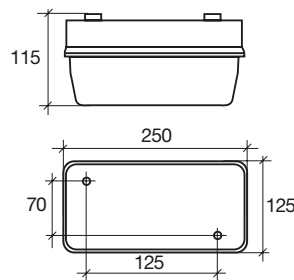

gr.		
1200	250 V 60 W max	050SPL60

Portalamпада E 27. Classe \square ∇ \triangle IP 44. Resistente alla fiamma ed all'accensione secondo norme IEC 695-2-1 e CEI 50-11. Diffusore in policarbonato. Idonea per accogliere lampade a basso consumo.

Lamp-holder E 27 Class \square ∇ \triangle IP 44. Resistant to flame and ignition conforming to IEC 695-2-1 and CEI 50-11. Polycarbonate diffusor. Suitable for energy saver bulbs.

Sistema di illuminazione interno quadro *Lighting system for industrial cabinets*



SISTEMA POSIZIONABILE FINECORSA - SYSTEM POSITIONING LIMIT SWITCH



140 Finecorsa 2NC su staffa e pressacavo
Limit switch 2NC on bracket, with cable gland

050F02S



150 Finecorsa 2NC su staffa e pressacavo con cablaggio
Limit switch 2NC on bracket, with cable gland and wiring

050F02SC

ESEMPI DI INSTALLAZIONE - MOUTING EXAMPLES

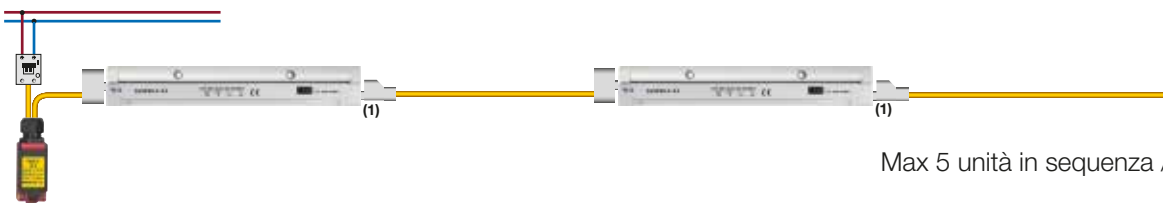
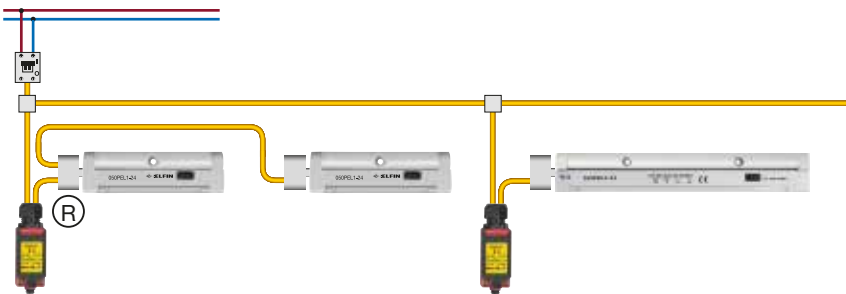
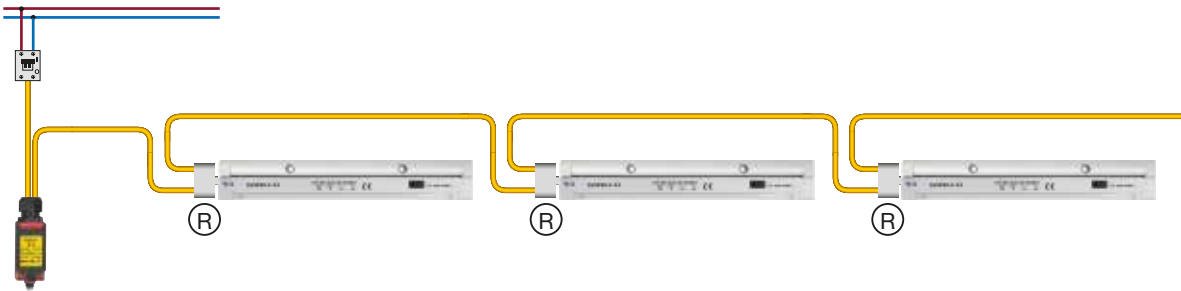

(1)= 050C7M

Max 5 unità in sequenza / 5 sequential unit max



APPARECCHI DI SEGNALAZIONE LAMPEGGIANTE PER INSTALLAZIONE INTERNO QUADRI FLASHING SIGNALLING DEVICES FOR INSTALLATION INSIDE CABINETS

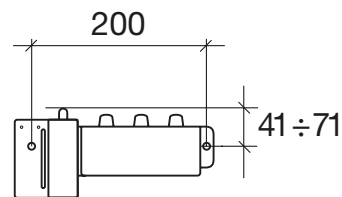
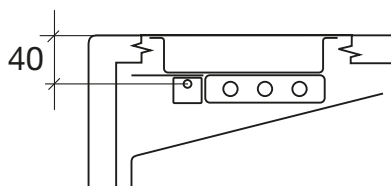

gr.	Tensione di alimentazione/power supply voltage	Configurazione/ configuration
430	$\textcircled{3V}$ 220÷690 V. 50÷60 Hz $\textcircled{1V}$ 110÷400 V. 50÷60 Hz	con finecorsa with limit switch ⁽¹⁾ 050ASL3

APPARECCHI DI SEGNALAZIONE LAMPEGGIANTE CON FINECORA D'INTERBLOCCO PER INSTALLAZIONE INTERNO QUADRI FLASHING SIGNALLING DEVICES WITH INTERLOCK LIMIT SWITCH FOR INSTALLATION INSIDE CABINETS

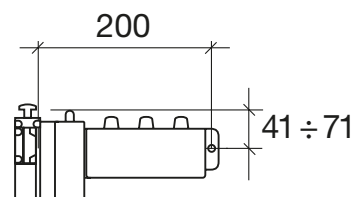
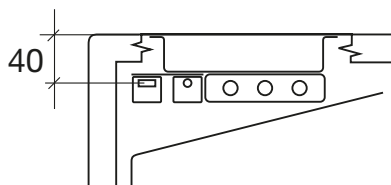

gr.	Tensione di alimentazione/power supply voltage	Configurazione/ configuration
490	$\textcircled{3V}$ 220÷690 V. 50÷60 Hz $\textcircled{1V}$ 110÷400 V. 50÷60 Hz	interblocco / interlock 1NC ⁽²⁾ 050ASL3FI01 interblocco / interlock 1NO ⁽³⁾ 050ASL3FI10

050



gr.	Configurazione / configuration
167	pulsante luminoso lampeggiante alimentazione diretta 24V con led lampeggiante rosso 24V <i>flashing direct power supply 24V with flashing red led 24V</i> pulsante luminoso senza lampadina <i>illuminated push-button without bulb</i> 050ASPD11
	1 NA + 1 NC 050ASPLD11 1 NC 050ASPLD01 1 NA 050ASPLD10 1 N A + 1 N C

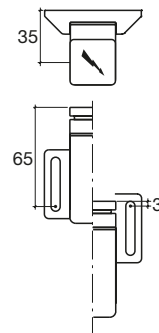

(1) Finecorsa tripolare cablato al lampeggiante. Determina l'inserimento solo quando le porte dell'armadio sono aperte.
 (2) A lancio di corrente.
 (3) Di minima tensione.

(1) Three-pole unit switch wired to the flashing device. Switch this on only when the doors of the cabinet are opened.
 (2) With current in rush.
 (3) With minimum voltage.



DISPOSITIVO DI SEGNALAZIONE LAMPEGGIANTE / FLASHING SIGNALLING DEVICE



gr. 90

Tensione di alimentazione/power supply voltage

3V AC 220÷690V 50÷60 Hz

1V DC*/AC 110÷400V 50÷60 Hz

050DSL

*NON POLARIZZATO - NOT POLARIZED

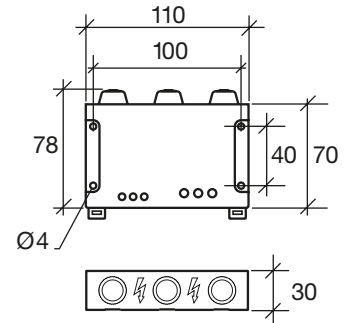

CARATTERISTICHE TECNICHE / TECHNICAL DATA

RISPONDEZZA ALLE NORME CONFORMING TO STANDARDS

OMOLOGAZIONI/ APPROVALS

PROTEZIONI CLIMATICHE PROTECTIVE TREATMENT

LIMITI DI TEMPERATURA AMBIENT TEMPERATURE

PROTEZIONE ALLA SCOSSA ELETTRICA ELECTRIC SHOCK PROTECTION

TENSIONE NOMINALE DI ISOLAMENTO RATED INSULATION VOLTAGE

GRADO DI INQUINAMENTO LEVEL OF POLLUTION

MORSETTI TERMINALS

CONFORMITA' ALLE DIRETTIVE EMC/RoHS COMPLIANCE WITH EMC/RoHS DIRECTIVES

ASSORBIMENTO MAX MAX CONSUPTION

COLLEGAMENTI CONNECTIONS

IEC 947-5-1. CEI 7.45 VDE - UTE - BSI CENELEC, EN 60947.5.1

UL (USA - CANADA)

In esecuzione normale T.C. tutti i climi / Standard version: "TC"

Funzionamento/Operation $\geq -25^{\circ}\text{C} \div \leq +65^{\circ}\text{C}$. Stoccaggio/Storage $\geq -35^{\circ}\text{C} \div \leq +70^{\circ}\text{C}$.

Classe II doppio isolamento secondo IEC 536 / Class II double insulation conforming to IEC 536

Ui 690 A.C.

Classe 3 secondo DIN VDE 0110 / Class 3 conforming to DIN VDE 0110

Fase / Phase L1 - L2- L3 - Coppia / torque max 1Nm - Ø vite a taglio 5mm
max 1 conduttore / conductor 4mm² / 10AWG

Ausiliari / Aux Coppia / torque max 0,5Nm - Ø vite a taglio 3,5mm
max 1 conduttore / conductor 2,5mm² / 12AWG

Grado di protezione morsetti / Protection degree: IP2X secondo/conforming to IEC 529

EN 50014-1, EN 50082-2, EN 55022, EN 61000-4-2÷11, EN 61000-6-2÷31. Immunità alle ESD. Immunità di BURST. Direttive: EMC EC 2004/108 - RoHS EC 2002/95
EN 50014-1, EN 50082-2, EN 55022, EN 61000-4-2÷11, EN 61000-6-2÷31. Immunity to ESD. Immunity to BURSTS. Directives: EMC EC 2004/108 - RoHS EC 2002/95

10 mA

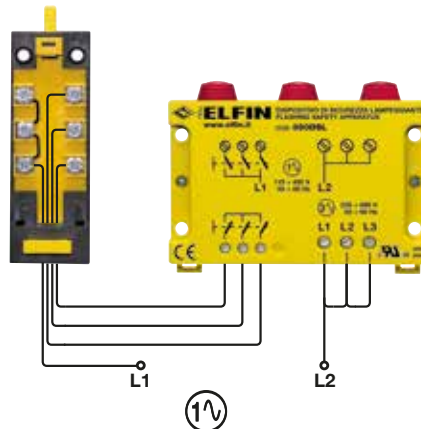

MONOFASE - ONE PHASE

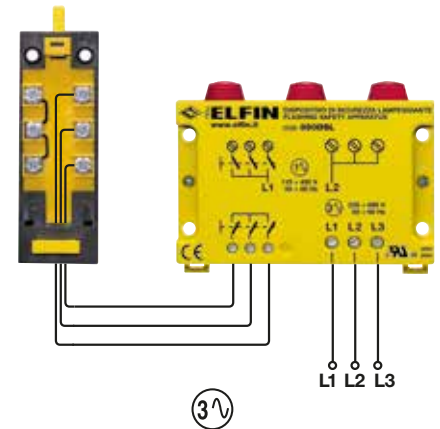

TRIFASE - THREE PHASE



050



FINECORSА TRIPOLARI TIPO FC / FC TYPE THREE-POLE LIMIT SWITCH



VERSIONE		2	4	6	
3NC	1-2 3-4 5-6	■	■	■	050FC3C
2NC+1NO	1-2 3-4 5-6	■	■	■	050FC2C
1NC+2NO	1-2 3-4 5-6	■	■	■	050FC1C
3NO	1-2 3-4 5-6	■	■	■	050FC0C

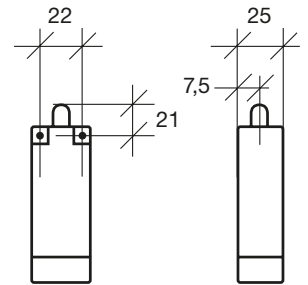

CARATTERISTICHE TECNICHE / TECHNICAL DATA

**RISPONDEZZA ALLE NORME
CONFORMING TO STANDARDS**

OMOLOGAZIONI / APPROVALS

**GRADO PROTEZIONE MORSETTI
TERMINAL DEGREE OF PROTECTION**

**MOMENTO TORCENTE MORSETTI
TERMINAL TORQUE**

**TENSIONE NOMINALE DI ISOLAMENTO U_i
RATED INSULATION VOLTAGE U_i**

**CORRENTE NOMINALE TERMICO I_{th}
RATED THERMAL CURRENT I_{th}**

**POTENZE NOMINALI DI IMPIEGO
RATED OPERATIONAL POWER**

**FUNZIONAMENTO CONTATTI
CONTACT OPERATION**

IEC 947-5-1.

CSA (CANADA) - UL (USA) solo versione 050FC3C / version 050FC3C only

IP40 secondo IEC 529

↻ max 0,5Nm, vite/screw M3,5 serrafilo autosollevante, testa combinata/ self-lifting captive cable clamp, combined head DIN 7962 31x0,05mm², ±2x2,5mm²

690 V

10A

Secondo/conforming to IEC 947-5-1
catAC15

Tensione/Voltage U _e	V	110	220	380	500	600
Corrente/Current I _e	A	6	3	2	1,5	1,2

Azionamento lento autopulenti a strisciamento, NC azione positiva (→)

Slow break, self-cleaning sliding activation, NC, positive action (→)

050

VITI PER MONTAGGIO ELEMENTI DI CONTATTO F-AP E F-CP
SCREWS FOR CONTACT ELEMENT ASSEMBLY F-AP AND F-CP



gr.	Montaggio / assembly	
2	1 elemento / element	● 030V28
3	2 elementi sovrapposti / elements overlapped	● 030V46
4	3 elementi sovrapposti / elements overlapped	● 030V64

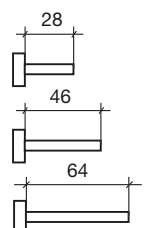



FINECORSA INTERBLOCCO PER CIRCUITI AUSILIARI E DI SERVIZIO INTERLOCK LIMIT SWITCHES FOR AUXILIARY AND SERVICE CIRCUITS



gr. 57

È un dispositivo che viene azionato direttamente da ogni porta dell'armadio elettrico. Di norma vengono collegati sul primo elemento di contatto (unico su cui può intervenire il dispositivo di interblocco) i circuiti ausiliari degli apparecchi di manovra. I restanti contatti montati posteriormente, vengono utilizzati per i circuiti di servizio, quali ad esempio: accensione luce armadio, inserimento ventole, condizionatore, segnalatori acustici, colonnine luminose. A porte aperte può essere commutato manualmente mediante una comoda ancoretta, contrassegnata da una freccia, realizzando svariate funzioni⁽³⁾.
This device is activated directly by each door of the cabinet. The auxiliary circuits of the switchgear are usually connected on the first contact element (the only one on which the interlock device can act). The remaining contacts mounted to the rear are used for the service circuits such as, for example: switching on of the cabinet light, activation of fans, conditioner, audible signals, beacons. With the doors open, it can be activated manually using a handy button marked by an arrow, performing various functions⁽³⁾.



gr. 101

Diagramma	Schema	Modello
		050FI01 ⁽¹⁾
		050FI10 ⁽²⁾
		050FI03 ⁽¹⁾
		050FI12 ⁽²⁾
		050FI01 ⁽¹⁾ +FCP+FAP
		050FI10 ⁽²⁾ +FCP+FAP

Il ripristino delle condizioni normali avviene ad ogni chiusura della porta dell'armadio
Normal conditions are reset each time the door of the cabinet is closed.

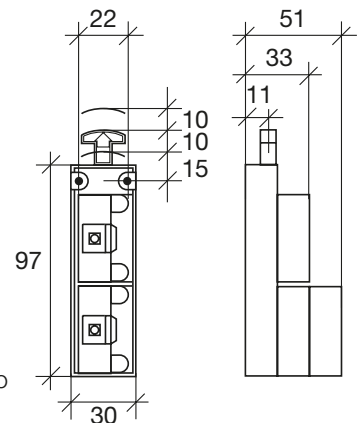

ELEMENTI DI CONTATTO PER FINECORSA INTERBLOCCO⁽⁴⁾ CONTACT ELEMENTS FOR INTERLOCK LIMIT SWITCH⁽⁴⁾



gr. 23

contatto/contact	schema/diagram	colore protezione/colour of protection	Modello
1NA			▲ 030FA-P
1NC			▲ 030FC-P

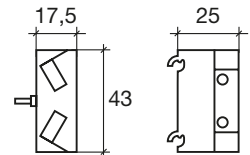

CARATTERISTICHE TECNICHE/TECHNICAL DATA

RISPONDEZZA ALLE NORME CONFORMING TO STANDARDS

IEC 947-5-1 VDE 0660 - UTE - BSI CENELEC

OMOLOGAZIONI / APPROVALS

CSA (CANADA) / UL (USA)

GRADO PROTEZIONE MORSETTI TERMINAL DEGREE OF PROTECTION

IP 2X secondo/conforming to IEC 529

MOMENTO TORCENTE MORSETTI TERMINAL TORQUE

1,5 Nm, vite M4 serrafilo autosollevante imperdibile $\geq 3 \text{ mm}^2$, $\leq 2 \times 2,5 \text{ mm}^2$
 1,5 Nm screw M4 self-lifting captive cable clamp $\geq 3 \text{ mm}^2$, $\leq 2 \times 2,5 \text{ mm}^2$

TENSIONE NOMINALE DI ISOLAMENTO Ui RATED INSULATION VOLTAGE Ui

690 V secondo/conforming to IEC 947-5-1

CORRENTE NOMINALE TERMICO Ith RATED THERMAL CURRENT Ith

10A

POTENZE NOMINALI DI IMPIEGO RATED OPERATIONAL POWER

Secondo/conforming to IEC 947-5-1
catAC15

Tensione/Voltage Ue	V	60	110	220	380	500	600
Corrente/Current Ie	A	10	6	3	2	1,5	1,2

FUNZIONAMENTO CONTATTI CONTACT OPERATION

Azionamento lento con NC azione positiva/Slow break with positive action on NC contact

DURATA / DURABILITY

Meccanica/mechanical 1.0×10^6 manovre/operations - Elettrica/electrical 5.0×10^5 manovre/operations

- (1) A lancio di corrente.
- (2) Di minima tensione.
- (3) Per combinazioni diverse, acquistare elementi di contatto separati.
- (4) Per prestazioni e caratteristiche dei contatti, vedere capitolo relativo nel catalogo pulsantiera "Serie EL-SG ø 30" forniti con viti di fissaggio.

- (1) Current inrush
- (2) With minimum voltage
- (3) For different combinations, purchase separate contact elements
- (4) For contact performance and characteristics, see the related chapter in the push-button catalogue "Series EL SG ø 30" c/w lock screws



FINECORSA BIPOLARE / TWO-POLE LIMIT SWITCH



gr.		
60	finecorsa/limit switch 1NC + 1NO	050F11
	finecorsa/limit switch 2NC	050F02
	finecorsa/limit switch 2NO	050F20

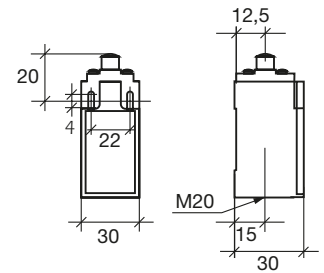

CARATTERISTICHE TECNICHE / TECHNICAL DATA

RISPONDEZZA ALLE NORME CONFORMING TO STANDARDS

OMOLOGAZIONI / APPROVALS

GRADO PROTEZIONE MORSETTI TERMINAL DEGREE OF PROTECTION

TEMPERATURA DI UTILIZZO OPERATING TEMPERATURE

TENSIONE NOMINALE DI ISOLAMENTO U_i RATED INSULATION VOLTAGE U_i

CORRENTE NOMINALE TERMICA RATED THERMAL CURRENT

POTENZE NOMINALI DI IMPIEGO RATED OPERATIONAL POWER

EN 50047

Nr. E224315 (UL - CSA)

IP65 secondo/according to IEC 529

-10 ÷ +80° C

U_i 690V secondo/according to IEC 947-5-1

I_{th}: 10A

Secondo/according to IEC 947-5-1 / UL 508

AC15 - A600

Tensione/Voltage U _e	V	24	110	220	400	600
---------------------------------	---	----	-----	-----	-----	-----

Corrente/Current I _e	A	10	6	3	1,5	1,2
---------------------------------	---	----	---	---	-----	-----

DC13 - Q 300

Tensione/Voltage U _e	V	24	110	230
---------------------------------	---	----	-----	-----

Corrente/Current I _e	A	2,5	0,6	0,3
---------------------------------	---	-----	-----	-----

FUNZIONAMENTO CONTATTI CONTACT OPERATION

DURATA / DURABILITY

Azionamento lento con NC azione positiva/Slow break with positive action on NC contact

Velocità di azionamento/Operating speed 0,05 ÷ 2 m/sec

Meccanica/mechanical 1.0x10⁷ manovre/operations - Elettrica/electrical 5.0x10⁵ manovre/operations



gr.	Pressacavi	
10	pressacavo 2 ingressi/2 gate cable gland	0102P20
13	pressacavo 1 ingresso/1 gate cable gland	010NM20
45	pressacavo 2 vie/2 way cable gland	010N2M20

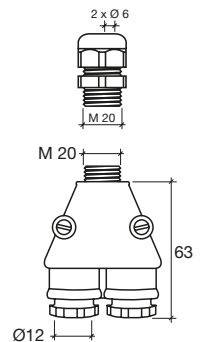

ACCESSORI / ACCESSORIES



gr.	Connettore bipolare/Two pin connector	050C7
14		

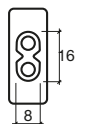

gr.	Cavo bipolare / two pole cable FROR NPI 2x0,75 mm ² matassa cavo / cable harness mt 100 - norme/omologation CEI 20-22 II tensione es. / rated voltage 300-500V	
4300		050CB075G
4300		050CB075A

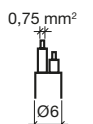

gr.	Cavo bipolare con terra / two pole cable with earth FROR NPI 2x15 mm ² - 1x15 mm ² matassa cavo / cable harness mt 100 - norme/omologation CEI 20-22 II tensione es. / rated voltage 300-500V	
4300		050CBG1A

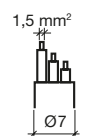

gr.	Cavo tripolare con terra / three pole cable with earth FROR NPI 3x15 mm ² matassa cavo / cable harness mt 100 - norme/omologation CEI 20-22 II tensione es. / rated voltage 300-500V	
4300		050CCT1A

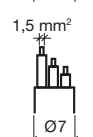

Sistema di illuminazione interno quadro Lighting system for industrial cabinets



RISCALDATORE ANTICONDENZA / ANTI-CONDENSATE HEATER



gr.	Potenza Termica Heating capacity	Corrente Accensione max Max inrush current	Temperatura Aria in uscita Air temperature output	L	H	P	
290	50 W	2,5 A	+86° C	60	110	90	050RA50
300	100 W	4,5 A	+120° C	60	110	90	050RA100
440	150 W	8 A	+145° C	60	150	90	050RA150

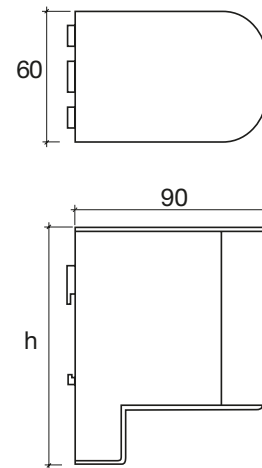

CARATTERISTICHE TECNICHE / TECHNICAL DATA

TENSIONE NOMINALE / POWER SUPPLY VOLTAGE
ELEMENTO TERMICO / HEATING ELEMENT
TEMPERATURA DELLA SUPERFICE / SURFACE TEMPERATURE
CONNESSIONE / CONNECTION

FISSAGGIO / MOUNTING

ALLOGGIAMENTO / HOUSING

POSIZIONE DI MONTAGGIO / FITTING POSITION

LIMITI DI TEMPERATURA / TEMPERATURE LIMITS

GRADO DI PROTEZIONE / PROTECTION DEGREE

CLASSE DI PROTEZIONE / PROTECTION CLASS

NORME / STANDARDS

120 - 250V AC/DC

Conduttore a freddo (PTC) autoregolante / PTC resistor self regulating < +80°C

4 morsetti 2,5 mm², coppia max di serraggio 0,8 Nm

4 terminals 2,5 mm², max clamping torque 0,8 Nm

Barra DIN 35 mm EN 50022 / 35 mm DIN rail EN 50022

Plastica UL94 V-0 nera / Plastic according UL94 V-0 black

Verticale / Vertical

-45°÷+70°C Funzionamento e stoccaggio / Functioning and stocking

IP20

II Doppio isolamento / Double insulated

VDE

ESEMPI DI INSTALLAZIONE / MOUNTING EXAMPLES

TERMOSTATI AD IMPOSTAZIONE FISSA THERMOSTAT WITH FIXING TEMPERATURE

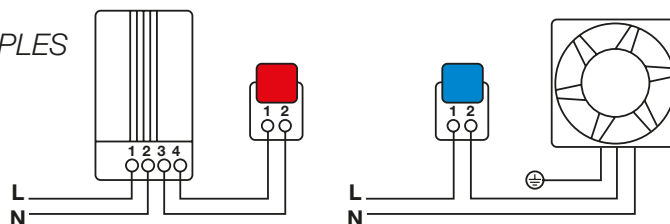

gr.	Contatto di apertura NC Contact breaker NC	Temperatura spegnimento Switch off temperature	
23	+15° C	+5° C	050TNC5
23	+25° C	+15° C	050TNC15



gr.	Contatto di chiusura NO Contact maker NO	Temperatura accensione Switch on temperature	
23	+35° C	+25° C	050TNO35
23	+50° C	+40° C	050TNO50
23	+60° C	+50° C	050TNO60

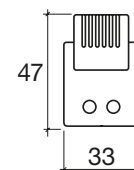
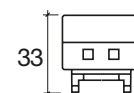

050

CARATTERISTICHE TECNICHE / TECHNICAL DATA

SONDA / SENSOR ELEMENT

TIPO DI CONTATTO / CONTACT TYPE

RESISTENZA DI CONTATTO / CONTACT RESISTANCE

DURATA UTILE / SERVICE LIFE

POTERE DI APERTURA MAX / MAX SWITCHING CAPACITY

CORRENTE DI ACCENSIONE MAX / MAX INRUSH CURRENT

EMC

CONNESSIONE / CONNECTION

FISSAGGIO / MOUNTING

ALLOGGIAMENTO / HOUSING

POSIZIONE DI MONTAGGIO / MOUNTING POSITION

LIMITI DI TEMPERATURA / TEMPERATURE LIMITS

GRADO DI PROTEZIONE / PROTECTION DEGREE

NORME / STANDARDS

A termostato / Thermostat

A scatto / Snap - action

< 20 mΩ

> 100.000 cicli / cycles

240 VAC 5 (1,6)A

DC 30W

AC 10A

Secondo / In according to EN 55014-1-2, EN 61000-3-2, EN 61000-3-3

2 morsetti 2,5 mm², coppia max di serraggio 0,8 Nm

2 terminals 2,5 mm², max clamping torque 0,8 Nm

Barra DIN 35 mm EN 50022 / 35 mm DIN rail EN 50022

Plastica UL94 V-0 grigio luminoso / Plastic according to UL94 V-0 light grey

Qualsiasi / Anyone

-20°÷+80°C Funzionamento / Functioning • -45°÷+80°C Stoccaggio / Stocking

IP20

VDE



Sistema di illuminazione interno quadro Lighting system for industrial cabinets

LAMPADA CON PRESA VDE / LIGHT WITH VDE SOCKET



1050

050LQPVDE

CARATTERISTICHE TECNICHE / TECHNICAL DATA

ALIMENTAZIONE/POWER SUPPLY	230V/50Hz
LAMPADA/BULB	Fluorescente a risparmio energetico - 11W Energy saving fluorescent
LUMINOSITA'/BRIGHTNESS	900 Lm
DURATA/LIFE	5.000 h
INTERFERENZE RADIO/RADIO INTERFERENCE	A norme/Complying with VDE 0712 IEC 82
PRESA DI CORRENTE/SOCKET	Incorporata/Incorporated 250V AC/16A
INSTALLAZIONE/INSTALLATION	Con piastra magnetica inclusa o guida DIN ⁽³⁾ With magnetic plate or DIN bracket
MATERIALE/MATERIAL	Termoplastico/Thermoplastic
GRADO DI PROTEZIONE/DEGREE OF PROTECTION	IP 20
NORME/STANDARDS	VDE

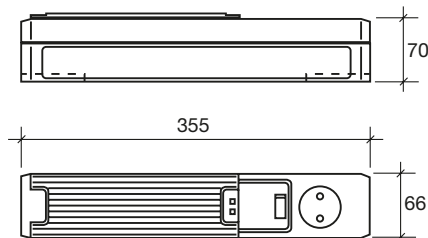

LAMPADA REMOVIBILE PER QUADRO CON PULSANTE ON/OFF/ LIGHT FOR CABINET WITH PRESENCE SENSOR



619

050LQP

CARATTERISTICHE TECNICHE / TECHNICAL DATA

ALIMENTAZIONE/POWER SUPPLY	220-240V / 50-60Hz
LAMPADA/BULB	Fluorescente a risparmio energetico Energy saving fluorescent- 20W attacco/attachment E 27
LUMINOSITA'/BRIGHTNESS	1.000 Lm
COLORE LUCE/COLOUR OF LIGHT	Bianco/White
DURATA/LIFE	10.000 h
INSTALLAZIONE/INSTALLATION	Con viti o piastra magnetica ⁽²⁾ With screws or magnetic plate ⁽²⁾
MATERIALE/MATERIAL	Termoplastico/Thermoplastic
GRADO DI PROTEZIONE/DEGREE OF PROTECTION	IP 20 - classe/class II

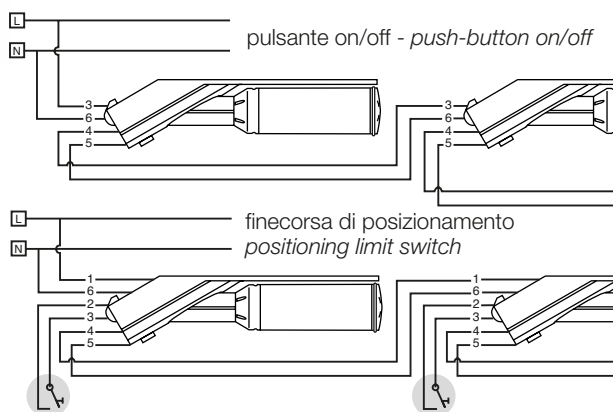

LAMPADA REMOVIBILE PER QUADRO CON SENSORE DI MOVIMENTO/ LIGHT FOR CABINET WITH ON/OFF SWITCH



622

050LQS

CARATTERISTICHE TECNICHE / TECHNICAL DATA

ALIMENTAZIONE/POWER SUPPLY	220-240V / 50-60Hz
LAMPADA/BULB	Fluorescente a risparmio energetico Energy saving fluorescent- 20W attacco/attachment E 27
LUMINOSITA'/BRIGHTNESS	1.000 Lm
COLORE LUCE/COLOUR OF LIGHT	Bianco/White
DURATA/LIFE	10.000 h
INSTALLAZIONE/INSTALLATION	Con viti o piastra magnetica ⁽²⁾ With screws or magnetic plate ⁽²⁾
MATERIALE/MATERIAL	Termoplastico/Thermoplastic
GRADO DI PROTEZIONE/DEGREE OF PROTECTION	IP 20 - classe/class II

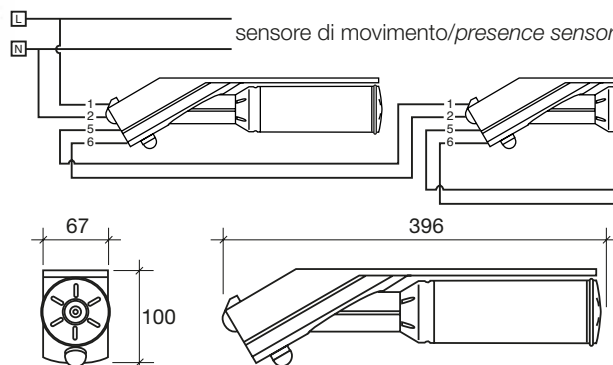

(1) Non utilizzare su quadri con porte in cristallo o materiali trasparenti
(2) Vedi capitolo staffe a pag. 15 - (3) Vedi ns. codice 080G3508

(1) Not to be used on cabinets with doors made of glass or transparent materials
(2) See brackets chapter on page 15 - (3) See code 080G3508

Sistema di illuminazione interno quadro Lighting system for industrial cabinets



LAMPADA REMOVIBILE PER QUADRO/ REMOVABLE LIGHT FOR CABINET



634

050LQR

CARATTERISTICHE TECNICHE / TECHNICAL DATA

ALIMENTAZIONE/POWER SUPPLY	220-240V / 50-60Hz Corredata con cavo da 2 m <i>Complete with 2-m cable</i>
LAMPADA/BULB	Fluorescente a risparmio energetico <i>Energy saving fluorescent - 20W</i> 20W attacco/attachment E 27
LUMINOSITA'/BRIGHTNESS	1.000 Lm
COLORE LUCE/COLOUR OF LIGHT	Bianco/White
DURATA/LIFE	10.000 h
INSTALLAZIONE/INSTALLATION	Con viti / With screws
MATERIALE/MATERIAL	Termoplastico/Thermoplastic
GRADO DI PROTEZIONE/DEGREE OF PROTECTION	IP 20 - classe II

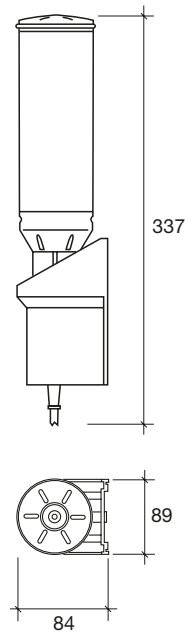

ACCESSORI PER LAMPADA AD USO MANUALE/ ACCESSORIES FOR MANUAL LIGHTS



SUPPORTO PER LAMPADE REMOVIBILI SUPPORT FOR REMOVABLE LIGHTS



234

050SLQ

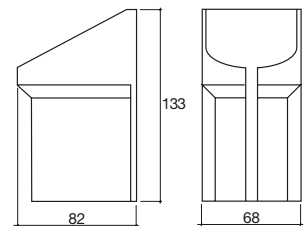

PRESA VDE CON FUSIBILE DI PROTEZIONE VDE SOCKET WITH PROTECTION FUSE



113 250V AC - 50/60Hz fusibile / fuse 6,3A

050PFVDE

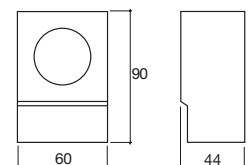

PRESA VDE VDE SOCKET



68 250V AC - 16A

050PVDE

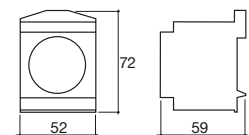

PRESA CEI CEI SOCKET



55 250V AC - 10/16A

050PCEI



CLIP PER BLOCCAGGIO CAVO⁽¹⁾ CLIP FOR CABLE CLAMPING⁽¹⁾



2

050CLIP

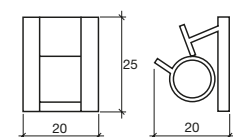

(1) Grazie a una comoda leva è possibile liberare il cavo per un eventuale uso manuale della lampada
(1) The cable can be released for hand-held use of the light using a handy lever.



ACCESSORI / ACCESSORIES



	Staffa base/main bracket	
230	passo/ pitch DIN 50	050S030

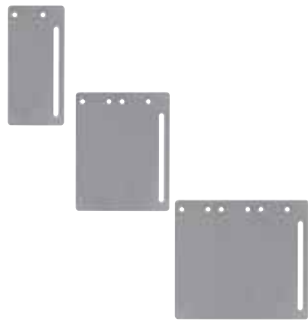
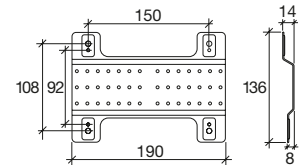

	Staffa slitta/sliding bracket	
48	1 fissaggio/fastener	050S031
86	2 fissaggi/fasteners	050S032
125	3 fissaggi/fasteners	050S033

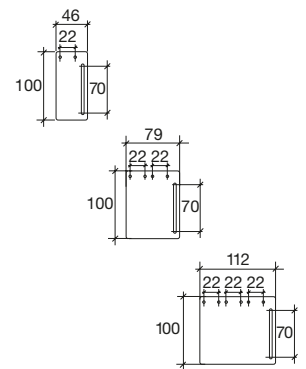

	Staffa base/basic bracket	
150	fissaggio interno quadri for fastening inside cabinets	050S001

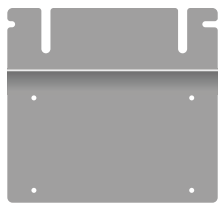
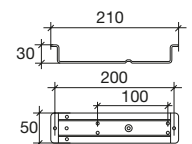

	Staffa slitta per plafoniera/sliding bracket for ceiling light	
670	incandescenza/incandescent	050S017

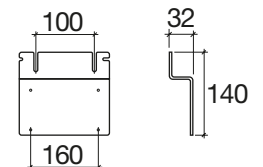

	Staffa adattatrice/adjustment bracket	
708		050SA005

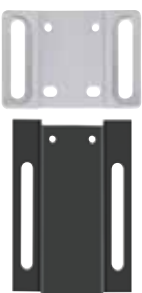
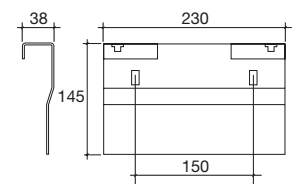

	Staffa a slitta fissaggio din/din sliding bracket	
23	1 fissaggio/fastener	050S003
86	1 fissaggio/fastener	050S003M

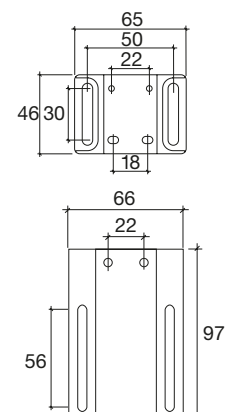

Viti di fissaggio incluse / Fixing screws included



L'utilizzo di questi componenti, unitamente ai componenti ed accessori elencati nei precedenti capitoli, permette di configurare l'apparecchio secondo le proprie esigenze.

Use of this component together with the devices and accessories listed above makes it possible to configure the appliance according to specific requirements.



ACCESSORI / ACCESSORIES



	Staffa guida omega /omega rail bracket	
128	DIN 35mm	050S013

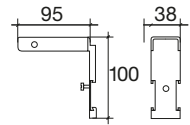

	Staffa per operatori/bracket for operators	
104		050S015

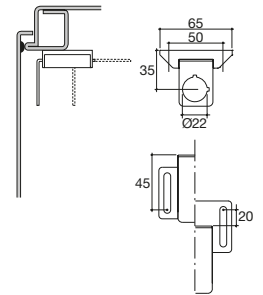

	Piastra magnetica/magnetic plate	
314	per plafoniere con presa tipo 050PPE8 - 050PPE13 e per lampada removibile 050LQP/QS for ceiling lamp type 050PPE8 - 050PPE13 and for removable lamp 050LQP/QS	050S019

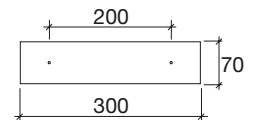

	Piastra magnetica/magnetic plate	
235	per plafoniera incandescente for incandescent ceiling light	050S020

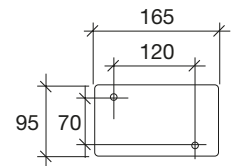

	Diffusori plafoniere fluorescenti / Diffuser fluorescent lamp	
26	per/for 020PE86C, 020PE8C	050DE8
48	per/for 020PE136C, 020PE13C	050DE13
70	per/for 020PE21C	050DE21



	Neon plafoniere fluorescenti / Neon fluorescent lamp	
32	per/for 020PE86C, 020PE8C	050TNE8
50	per/for 020PE136C, 020PE13C	050TNE13
80	per/for 020PE21C	050TNE21

UNITA' LUMINOSA⁽¹⁾ / ILLUMINATED UNITS⁽¹⁾



21		020LQBIRKS72

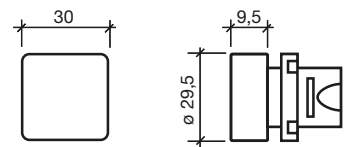

PULSANTI LUMINOSI⁽¹⁾ / ILLUMINATED PUSH-BUTTONS⁽¹⁾



25	normale/normal passo/pass - jog type	020PQAF LRKS72 020PPQAF LRKS72

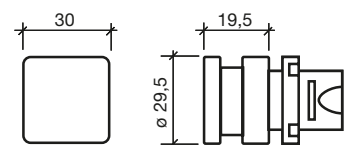

(1) Per altre versioni di operatori e portalampe, vedi catalogo ausiliari di comando e segnalazione SM2 020.
(1) For other versions of operators and lamp-holders, refer to the SM2 020 series manual pilot devices & 22 catalogue.



easy mounting

Colonne luminose Light towers



Gli attacchi a baionetta permettono un veloce montaggio della colonna, si posizionano gli elementi con le tacche, presenti sul corpo, allineate e si ruota l'anello di serraggio; i moduli così assemblati sono solidali fra di loro e non necessitano di cablaggi grazie connettori presenti nei moduli.

The coloured modules can be joined together with easy and fast movements, due to the bayonet connection system. All the elements have reference marks, which must be aligned each other, and subsequently the fixing ring rotation block the parts definitively. The assembled modules do not need other wiring operations because there are internal connectors to transmit the signals from a module to others.



La lampadina posizionata con l'attacco in alto si trova al centro del modulo così da distribuire la luce in modo uniforme ed essere visibile dal basso.

The bulb is positioned in the centre of the module with the base on top, so as to have a perfect evenly light distribution and an excellent visibility from below levels.



050

ESEMPI DI REALIZZAZIONI / EXAMPLES OF APPLICATION



050TMR

050TMA

050TMV

050TP100

050TBA



050TMA

050TP100

050TBA



050TMA

050TA

050TBA

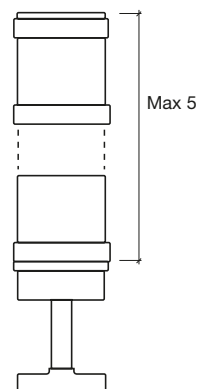

Colonne luminose Light towers



MODULO DI CONNESSIONE / CONNECTION MODULE



126 completo di base, connettore, coperchio
complete of base, connector, cover

050TBA

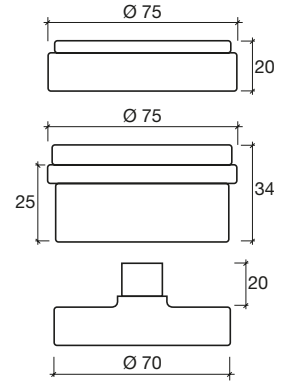

MODULI LUMINOSI LUCE FISSA ILLUMINATED FIX LIGHT



130 
130 
130 
130 
130 
130 

050TMR
050TMV
050TMG
050TMA
050TML
050TMI

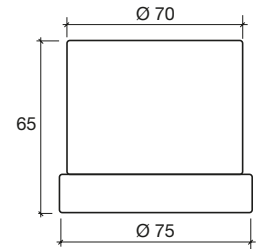

TUBI DI PROLUNGA / EXTENSION



6 anello di congiunzione / spacer

050TA





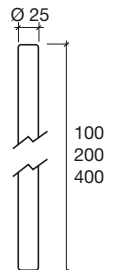

30 elemento da 100mm / long 100 mm
60 elemento da 200mm / long 200 mm
120 elemento da 400mm / long 400 mm

050TP100
050TP200
050TP400



LAMPADINE LED BA15D / BA15D LED BULB



					
24V AC-DC	010BA15DLR24	010BA15DLG24	010BA15DLV24	010BA15DLBL24	010BA15DLB24
230V AC-DC	010BA15DLR220	010BA15DLG220	010BA15DLV220	010BA15DLBL220	010BA15DLB220

TENSIONE DI ALIMENTAZIONE / POWER SUPPLY VOLTAGE
LAMPADINA BA15D / BULB BA15D
GRADO PROTEZIONE / PROTECTION DEGREE
CLASSE DI ISOLAMENTO / INSULATION CLASS
AUTOESTINGUENZA / SELF EXTINGUISHING CLASS
TEMPERATURE DI FUNZIONAMENTO / TEMPERATURE RANGE

Max 250V 50÷60Hz - 130V CC
Max 10W
IP44
II
V0
0°÷60°C

