

# HPA Series

Strobe light emission, high margin regulation, incoming light display on the front, and output suppression functions allow sensing range to be quickly and reliably adjusted.





- Strobe light emission permits easy confirmation of the sensing range (advanced function thru scan and polarized retroreflective models)
- The high margin regulation function permits adjustment of the sensing range at a margin three times greater than usual (advanced function thru scan and polarized retroreflective models)
- The front incoming light display facilitates adjustment of the sensing range (thru scan)
- The output suppression function permits secure adjustment of the sensing range while debugging the PLC (advanced function thru scan and polarized retroreflective models)
- An automatic pulse-phase shift system enhances mutual interference prevention (polarized retroreflective and diffuse scan models)
- Monoblock housing sealed to IP67



CLICK

## ORDER GUIDE

### ● Prelead type (2m cable)

Model	Detection method		Scanning distance	Light-ON/dark-ON selectable	Sensitivity adjustment	Self-diagnostic indication	Self-diagnostic output	Triple alignment function*1	Front incoming light indication	Supply voltage	Output mode	Catalog listing
Horizontal 	Thru scan	General use	10m	●	●*2	●	—	—	●	10 to 30Vdc	NPN open collector	HPA-T11
		Adv. function									PNP open collector	HPA-T12
											NPN open collector	HPA-T13
	Polarized retroreflective	General use	4m	●	●	●	●	●	—		PNP open collector	HPA-P11
		Adv. function									NPN open collector	HPA-P12
											PNP open collector	HPA-P13
		Polarized retroreflective for transparent object detection	0.3 to 1m								NPN open collector	HPA-P14
	Diffuse scan		20cm	●	●	●	—	—	—		NPN open collector	HPA-F11
			80cm								PNP open collector	HPA-D11
											PNP open collector	HPA-D12
Vertical 	Thru scan	General use	10m	●	●*2	●	—	—	●	NPN open collector	HPA-A11	
		Adv. function								PNP open collector	HPA-A12	
										NPN open collector	HPA-A21	
	Polarized retroreflective	General use	4m	●	●	●	●	—	—	PNP open collector	HPA-T21	
		Adv. function								NPN open collector	HPA-T22	
										PNP open collector	HPA-T23	
		Polarized retroreflective for transparent object detection	0.3 to 1m							NPN open collector	HPA-T24	
	Diffuse scan		20cm	●	●	●	—	—	—	NPN open collector	HPA-P21	
			80cm							PNP open collector	HPA-P22	
										NPN open collector	HPA-P23	
									PNP open collector	HPA-P24		
									NPN open collector	HPA-F21		
									NPN open collector	HPA-D21		
									PNP open collector	HPA-D22		
									NPN open collector	HPA-A21		
									PNP open collector	HPA-A22		

\*1. Triple alignment function for initial setup: stroboscopic light emission, high margin adjustment, output suppression.

\*2. On an advanced function models the emitter also has a variable adjustment potentiometer.

**Allegheny Electronics**  
 1301 Potomac Ave.  
 Hagerstown, MD 21742  
**TEL 800-296-6460 301-739-6460**  
**FAX 800-296-7674 301-739-5311**  
[www.alleghenyelectronics.com](http://www.alleghenyelectronics.com)

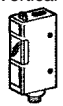

● Connector type

Model	Detection method		Scanning distance	Light-ON/dark-ON selectable	Sensitivity adjustment	Self-diagnostic indication	Self-diagnostic output	Triple alignment function <sup>*1</sup>		Front incoming light indication	Supply voltage	Output mode	Catalog listing	
Horizontal 	Thru scan	General use	10m	●	*2	●	●	—	—	●	10 to 30Vdc	NPN open collector	HPA-T31	
		Adv. function						●	●			—	—	—
	Polarized retroreflective	General use	4m	●	●	●	●	—	—	—		NPN open collector	HPA-T33	
		Adv. function						●	●			●	●	●
	Diffuse scan	20cm		●	●	●	—	—	—	—		NPN open collector	HPA-P31	
												80cm	●	●
		80cm	●	●	—	—	—	—	PNP open collector	HPA-P33				
									80cm	●		●	—	—
	20cm		●	●	●	—	—	—						
									80cm	●		●	—	—
	80cm	●	●	—	—	—	—	—						
									80cm	●		●	—	—
Thru scan	General use	10m	●	*2	●	●	—	—			●			
	Adv. function						●	●	●	●		●	—	—
Vertical 	Thru scan	General use	10m	●	*2	●	●	—	—	●	10 to 30Vdc	NPN open collector	HPA-T43	
		Adv. function						●	●			●	●	—
	Polarized retroreflective	General use	4m	●	●	●	●	—	—	—		NPN open collector	HPA-P41	
		Adv. function						●	●			●	●	●
	Diffuse scan	20cm		●	●	●	—	—	—	—		—	NPN open collector	HPA-P43
													80cm	●
		80cm	●	●	—	—	—	—	—	NPN open collector		HPA-D41		
										80cm		●	●	—
	20cm		●	●	●	—	—	—	—					
										80cm		●	●	—

\*1. Triple alignment function for initial setup: stroboscopic light emission, high margin adjustment, output suppression.

\*2. On advanced function models the emitter also has a variable adjustment potentiometer.

● Prelead connector type (30cm lead)

Model	Detection method		Scanning distance	Light-ON/dark-ON selectable	Sensitivity adjustment	Self-diagnostic indication	Self-diagnostic output	Triple alignment function <sup>*1</sup>		Front incoming light indication	Supply voltage	Output mode	Catalog listing	
Horizontal 	Thru scan	General use	10m	●	*2	●	●	—	—	●	10 to 30Vdc	NPN open collector	HPA-T51	
		Adv. function						●	●			—	—	—
	Polarized retroreflective	General use	4m	●	●	●	●	—	—	—		NPN open collector	HPA-T53	
		Adv. function						●	●			●	●	—
	Diffuse scan	20cm		●	●	●	—	—	—	—		—	NPN open collector	HPA-P51
													80cm	●
		80cm	●	●	—	—	—	—	—	NPN open collector		HPA-P53		
										80cm		●	●	—
	20cm		●	●	●	—	—	—	—					
										80cm		●	●	—
	80cm	●	●	—	—	—	—	—	—					
										80cm		●	●	—
Thru scan	General use	10m	●	*2	●	●	—	—	●		NPN open collector			
	Adv. function						●	●		●	●	—	—	PNP open collector
Vertical 	Thru scan	General use	10m	●	*2	●	●	—	—	●	10 to 30Vdc	NPN open collector	HPA-T63	
		Adv. function						●	●			●	●	—
	Polarized retroreflective	General use	4m	●	●	●	●	—	—	—		NPN open collector	HPA-P61	
		Adv. function						●	●			●	●	●
	Diffuse scan	20cm		●	●	●	—	—	—	—		—	NPN open collector	HPA-P63
													80cm	●
		80cm	●	●	—	—	—	—	—	NPN open collector		HPA-D61		
										80cm		●	●	—
	20cm		●	●	●	—	—	—	—					
										80cm		●	●	—

\*1. Triple alignment function for initial setup: stroboscopic light emission, high margin adjustment, output suppression.

\*2. On advanced function models the emitter also has a variable adjustment potentiometer.

**Allegheny Electronics - 1301 Potomac Ave. - Hagerstown, MD 21742**  
**TEL 800-296-6460 301-739-6460 - FAX 800-296-7674 301-739-5311 - www.alleghenyelectronics.com**

## SPECIFICATIONS

Detection method	Thru scan		Polarized retroreflective			Diffuse scan	
Model	General	Advanced function	General	Advanced function	Transparent object detection	Short distance	Long distance
Catalog listing	HPA-T□1 HPA-T□2	HPA-T□3 HPA-T□4	HPA-P□1 HPA-P□2	HPA-P□3 HPA-P□4	HPA-F11 HPA-F21	HPA-D□1 HPA-D□2	HPA-A□1 HPA-A□2
Supply voltage	10 to 30Vdc (ripple not over 10%)						
Current consumption	50mA max.*1 Emitter 20mA max. Receiver 30mA max.		40mA max.*1				
Scanning distance	10m		4m (with <b>FE-RR8</b> reflector)		0.3 to 1m	20cm	80cm
Target object	Opaque object, 8mm dia. min.		Opaque object 80mm dia. min. (with <b>FE-RR8</b> reflector)			—	
Standard target object	—		—			10 x 10cm white paper <sup>2</sup>	30 x 30cm white paper <sup>2</sup>
Directional angle	2 to 20°		Sensor body 1 to 5°, reflector 40°			—	
Differential travel	—		—			20%	
Operation mode	Light-operated/dark-operated, selectable by switch						
Output mode	NPN or PNP transistor open collector						
Control output	Switching current: 100mA max. (resistive load). Output dielectric strength: 30V max. Residual voltage: 1V max. (at 100mA switching current). Output short-circuit protection circuit						
Self-diagnostic output	No	Yes	No	Yes	No	No	No
	Switching current: 50mA max. (resistive load). Output dielectric strength: 30V max. Residual voltage: 1V max. (at 50mA switching current). Output short-circuit protection circuit						
Response time	0.5ms max. for both operation and reset		1ms max. for both operation and reset		0.5ms max. for both operation and reset	5ms max. for both operation and reset	
Sensitivity adjustment	Potentiometer (2 revolutions) with indicator						
Light emitter	Red LED					Infrared LED	
Indicator	Thru scan emitter: Power indicator (red while power is supplied); HPA-E13 has green SET mode indication Stability indication: Green during stable L.O. or D.O. operation, flashing during self-diagnostics Other indicators: Light-operated (L.O.) indicator (red).						
Ambient light immunity	Incandescent lamp: max. 5,000 lux. Sunlight: max. 20,000 lux.						
Operating ambient temp.	-25 to +60°C <sup>3</sup>						
Storage temperature	-40 to +70°C						
Humidity range	35 to 85% RH (non-condensing)						
Insulation resistance	20MΩmin. (by 500Vdc megger)						
Dielectric strength	1,000Vac, 50/60Hz for 1min between case and electrically live metal						
Vibration	10 to 55Hz, 1.5mm peak-to-peak amplitude, 2 hours each in X, Y, and Z directions						
Shock	490m/s <sup>2</sup> repeated 10 times each in X, Y, and Z directions						
Protective structure	IP67 (IEC standard)						
Wiring type	Preleaded / preleaded connector / connector						
Weight	About 55g (body only), with 2m cable						
Other	Equipped with a power ON/OFF malfunction prevention circuit (about 100ms) and reverse connection protection circuit						

\*1. During triple alignment current consumption increases about 30mA.

\*2. Kodak 90% white paper is used.

\*3. The triple alignment function should be used within a temperature range of 5 to 30°C.

## CATALOG LISTING

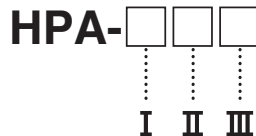







<b>I</b>	<b>Detection method:</b>
↓	
<b>T:</b>	Thru scan (E for emitter, R for receiver)
<b>P:</b>	Polarized retroreflective
<b>D:</b>	Short distance diffuse scan
<b>A:</b>	Long distance diffuse scan
<b>F:</b>	Polarized retroreflective

<b>II</b>	<b>Body, wiring type:</b>
↓	
<b>1:</b>	Horizontal, preleaded
<b>2:</b>	Vertical, preleaded
<b>3:</b>	Horizontal, connector
<b>4:</b>	Vertical, connector
<b>5:</b>	Horizontal, preleaded connector
<b>6:</b>	Vertical, preleaded connector

<b>III</b>	<b>Output mode/function:</b>
↓	
<b>1:</b>	General purpose NPN transistor output
<b>2:</b>	General purpose PNP transistor output
<b>3:</b>	Advanced function NPN transistor output (with self-diagnostic and triple alignment functions)
<b>4:</b>	Advanced function PNP transistor output (with self-diagnostic and triple alignment functions)

**Allegheny Electronics - 1301 Potomac Ave. - Hagerstown, MD 21742**  
**TEL 800-296-6460 301-739-6460 - FAX 800-296-7674 301-739-5311 - www.alleghenyelectronics.com**

## ACCESSORIES (sold separately)

Name	Appearance	Details	Catalog listing	Compatible models
Slit for thru scan model		One set of slits (2mm, 1mm, 0.5mm, 2mm dia., 1mm dia., and 0.5mm dia.) for emitter and receiver	HPA-U01	All thru scan models HPA-T□□
Mutual interference prevention filter for thru scan model		2 sets of filters (for emitter and receiver)	HPA-U02	All thru scan models HPA-T□□
Narrow view lens attachment		When lens is attached to the HPA-D, light focuses to a small spot 2mm in dia. at scanning distance of 30mm.	HPA-U03	All short distance diffuse scan models HPA-D□□
Small reflector for polarized retroreflective model		A small reflector used when mounting space for the reflector is tight. To be ordered separately from HPA-P□□ and HPA-F□□.	FE-RR15	All polarized retroreflective models HPA-P□□ HPA-F□□
Reflector for polarized retroreflective model		To be ordered separately from HPA-P□□ and HPA-F□□.	FE-RR8	All polarized retroreflective models HPA-P□□ HPA-F□□
Mounting bracket for vertical models		—	HPA-B02	All vertical models
Wraparound mounting bracket		—	HPA-B03	All models (cannot be used with a connector wiring type)

## CHARACTERISTICS DIAGRAMS

### ● Excess gain (light received over required level) (typical)

Thru scan model  
HPA-T

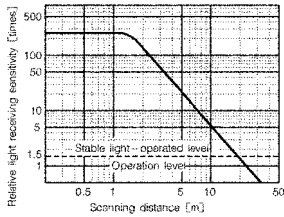

Thru scan model  
HPA-T + mutual interference prevention filter HPA-U02

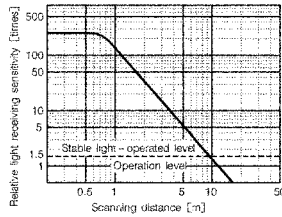

Polarized retroreflective model  
HPA-P + horizontal reflector FE-RR8/RR15

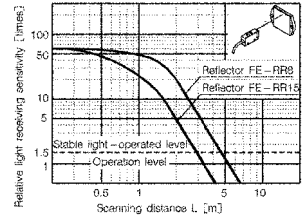

Polarized retroreflective model  
HPA-P + vertical reflector FE-RR8/RR15

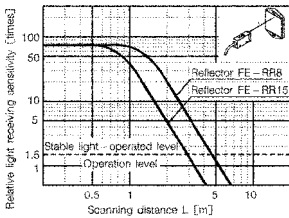

Short-distance diffuse scan model  
HPA-D

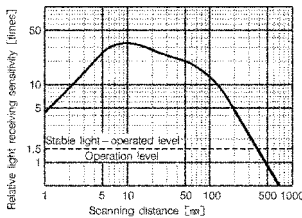

Long-distance diffuse scan model  
HPA-A

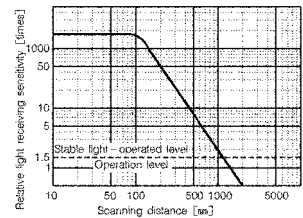

### ● PARALLEL DISPLACEMENT (typical)

Thru scan model  
HPA-T

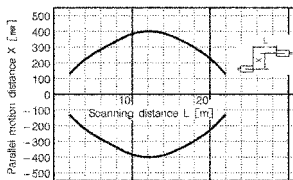

Thru scan model HPA-T + mutual interference prevention filter HPA-U02 on receiver

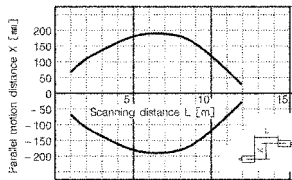

Polarized retroreflective model  
HPA-P + reflector FE-RR8/RR15 (vert. direction)

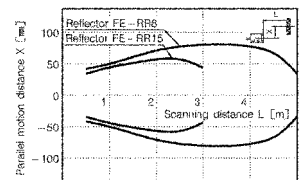

**Allegheny Electronics - 1301 Potomac Ave. - Hagerstown, MD 21742**

**TEL 800-296-6460 301-739-6460 - FAX 800-296-7674 301-739-5311 - www.alleghenyelectronics.com**

Polarized retroreflective model  
**HPA-P + reflector FE-RR8/RR15 (horiz. direction)**

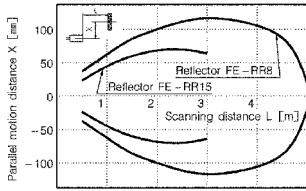

Polarized retroreflective for transparent targets model  
**HPA-F + reflector FE-RR8/RR15 (vert. direction)**

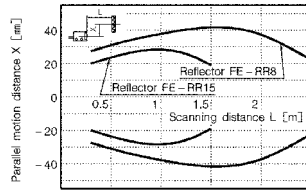

Polarized retroreflective for transparent targets model  
**HPA-F + small reflector FE-RR15 (horiz. direction)**

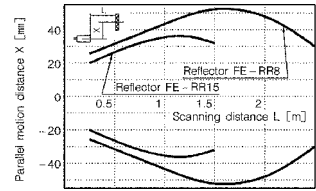

● **DETECTION AREA CHARACTERISTICS (typical)**

Short distance diffuse scan model  
**HPA-D**

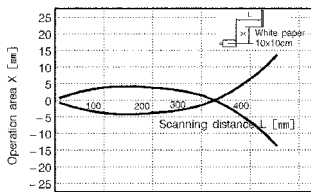

Short distance diffuse scan model  
**HPA-D + narrow view lens HPA-U03**

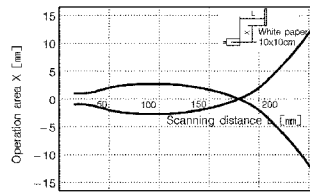

Long distance diffuse scan model  
**HPA-A**

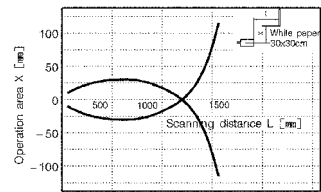

● **TARGET OBJECT WIDTH VS. SCANNING DISTANCE (typical)**

Short distance diffuse scan model  
**HPA-D**

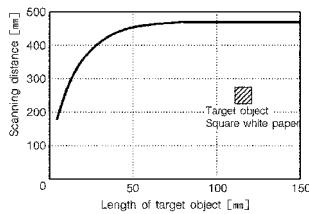

Short distance diffuse scan model  
**HPA-D + narrow view lens HPA-U03**

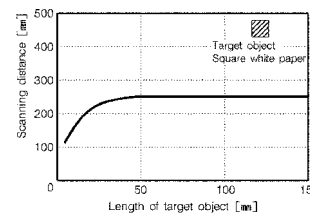

Long distance diffuse scan model  
**HPA-A**

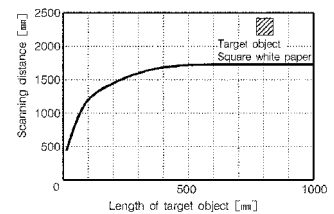

● **ANGULAR CHARACTERISTICS (typical)**

Thru scan model  
**HPA-T**

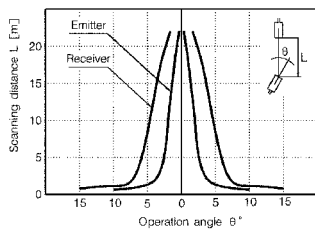

Polarized retroreflective model  
**HPA-P + reflector FE-RR8/RR15 (vert. direction)**

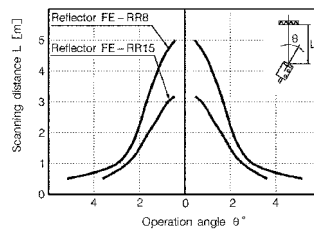

Polarized retroreflective model  
**HPA-P + reflector FE-RR8/RR15 (horiz. direction)**

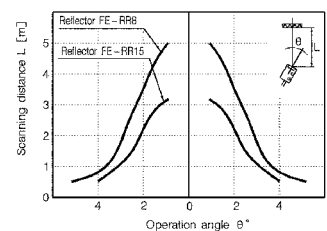

● **SCANNING DISTANCE VS. SPOT DIAMETER CHARACTERISTICS**

Short distance diffuse scan model  
**HPA-D + narrow view lens HPA-U03**

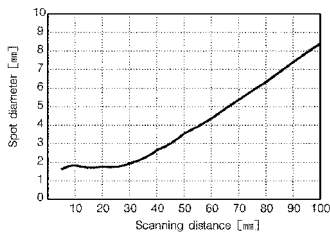

■ **TYPICAL SCANNING DISTANCES WITH SLIT (relative to distances without slit)**

Slit size	Slit used on emitter only	Slit used on receiver only	Slit used on emitter and receiver
2mm	46%	46%	18%
1mm	30%	32%	11%
0.5mm	16%	21%	3.6%
2mm dia.	15%	25%	3.6%
1mm dia.	4.8%	12%	0.6%

# EXTERNAL DIMENSIONS

(unit: mm)

## ● General use thru scan model (preleaded, preleaded connector)

Horizontal type  
**HPA-T11, T12, T51, T52**  
 Emitter

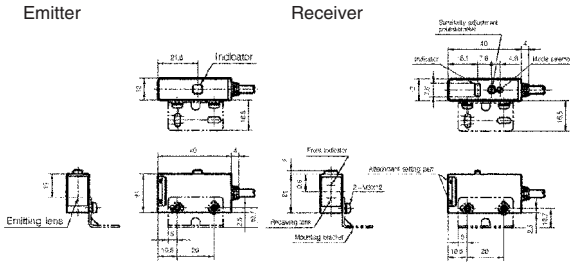

Receiver

## ● Advanced function thru scan model (preleaded, preleaded connector)

Horizontal type  
**HPA-T13, T14, T53, T54**  
 Both emitter and receiver

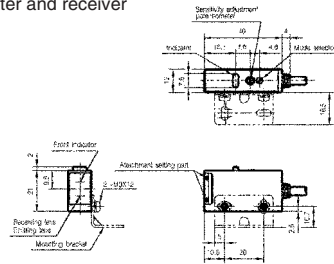

Polyvinyl chloride insulated cable (oil-resistant type: 0.2mm<sup>2</sup>), 4.2 dia.  
 Standard cable length 2m (preleaded)  
 Lead colors: Receiver: gray Emitter: black (preleaded), gray (preleaded connector)

Polyvinyl chloride insulated cable (oil-resistant type: 0.2mm<sup>2</sup>), 4.2 dia.  
 Standard cable length 2m (preleaded)  
 Lead colors: Receiver: gray Emitter: black (preleaded), gray (preleaded connector)

Vertical type  
**HPA-T21, T22, T61, T62**  
 Emitter

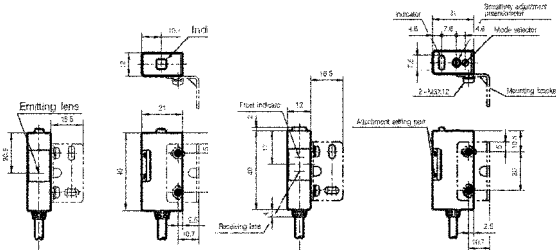

Receiver

Vertical type  
**HPA-T23, T24, T63, T64**  
 Both emitter and receiver

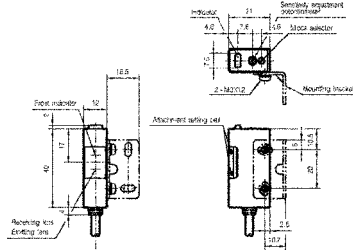

Polyvinyl chloride insulated cable (oil-resistant type: 0.2mm<sup>2</sup>), 4.2 dia.  
 Standard cable length 2m (preleaded)  
 Lead colors: Receiver: gray Emitter: black (preleaded), gray (preleaded connector)

Polyvinyl chloride insulated cable (oil-resistant type: 0.2mm<sup>2</sup>), 4.2 dia.  
 Standard cable length 2m (preleaded)  
 Lead colors: Receiver: gray Emitter: black (preleaded), gray (preleaded connector)

## ● Polarized retroreflective model (preleaded, preleaded connector)

Horizontal type  
**HPA-P11, P12, P13, P14, P51, P52, P53, P54, F11**

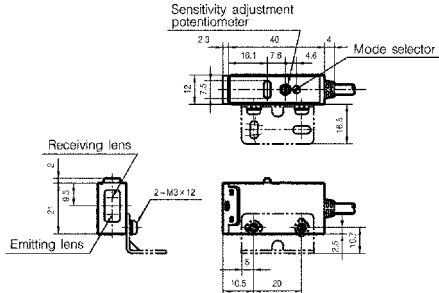

Polyvinyl chloride insulated cable (oil-resistant type: 0.2mm<sup>2</sup>), 4.2 dia.  
 Standard cable length 2m (preleaded)  
 Lead color: gray

Vertical type  
**HPA-P21, P22, P23, P24, P61, P62, P63, P64, F21**

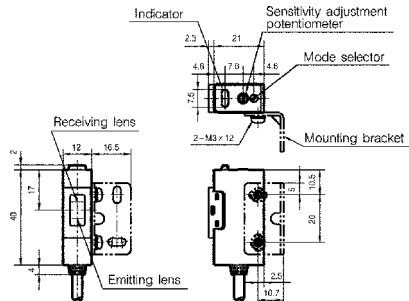

Polyvinyl chloride insulated cable (oil-resistant type: 0.2mm<sup>2</sup>), 4.2 dia.  
 Standard cable length 2m (preleaded)  
 Lead color: gray

**Allegheny Electronics**

1301 Potomac Ave.

Hagerstown, MD 21742

TEL 800-296-6460 301-739-6460

FAX 800-296-7674 301-739-5311

www.alleghenyelectronics.com

● Diffuse scan model (prelead, prelead connector)

(unit: mm)

Horizontal type  
HPA-D11, D12, A11, A12

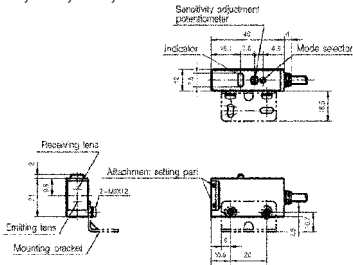

Polyvinyl chloride insulated cable (oil-resistant type: 0.2mm<sup>2</sup>), 4.2 dia.  
Standard cable length 2m (prelead)  
Lead color: gray

Vertical type  
HPA-D21, D22, A21, A22

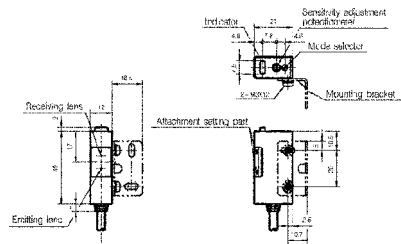

Polyvinyl chloride insulated cable (oil-resistant type: 0.2mm<sup>2</sup>), 4.2 dia.  
Standard cable length 2m (prelead)  
Lead color: gray

● General use thru scan model (connector)

Horizontal type  
HPA-T31, T32

Emitter

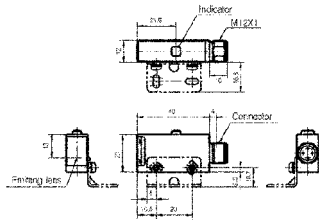

Receiver

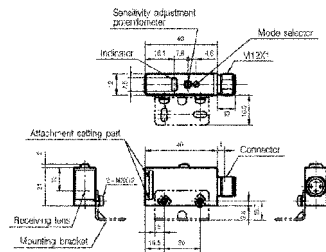

● Advanced function thru scan model (connector)

Horizontal type  
HPA-T33, T34

Both emitter and receiver

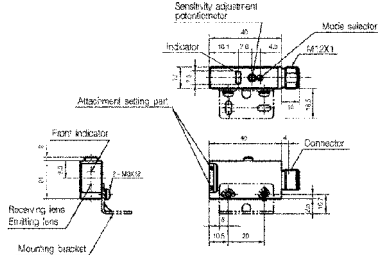

● General use thru scan model (connector)

Vertical type  
HPA-T41, T42

Emitter

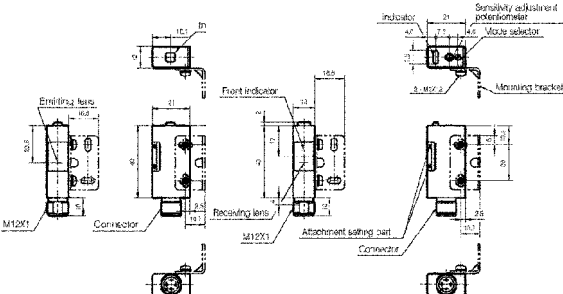

● Advanced function thru scan model (connector)

Vertical type  
HPA-T43, T44

Both emitter and receiver

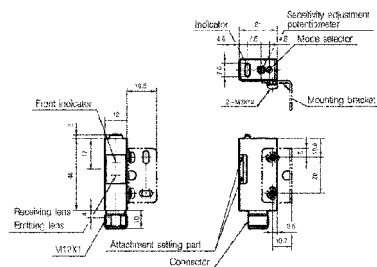



● Polarized retroreflective model (connector)

(unit: mm)

Horizontal type  
HPA-P31, P32, P33, P34

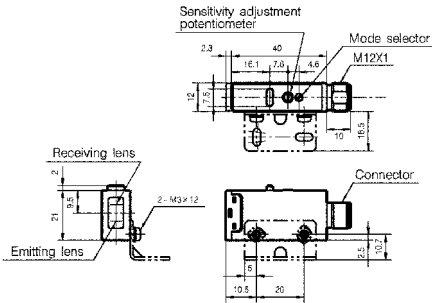

Vertical type  
HPA-P41, P42, P43, P44

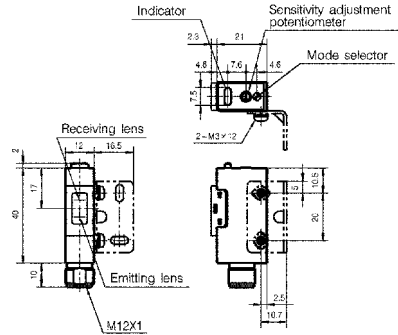

● Diffuse scan model (connector)

Horizontal type  
HPA-D31, D32, A31, A32

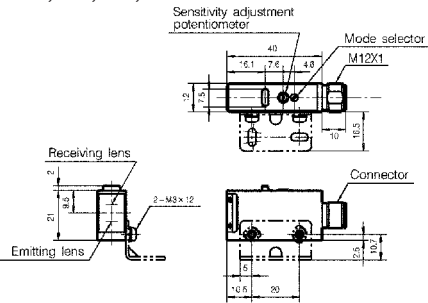

Vertical type  
HPA-D41, D42, A41, A42

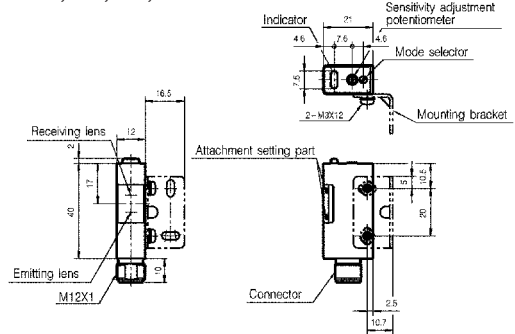

● Connector used in prelead connector type

HPA-□5□, □6□

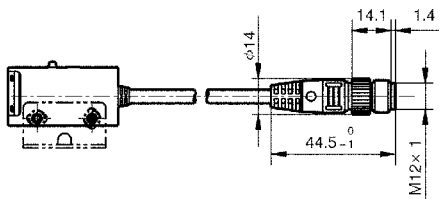

\*Cable length 30cm

● Bracket

HPA-B01 mounting bracket (included as standard)

With horizontal model

With vertical model

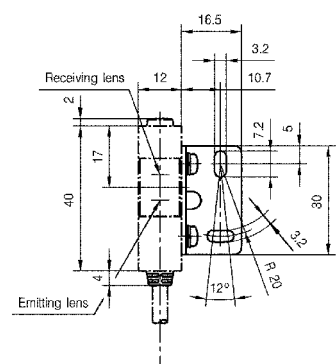
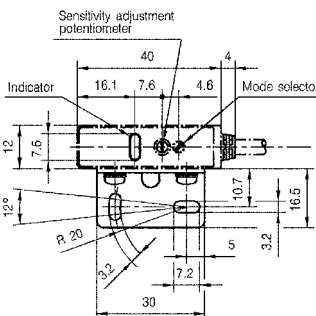
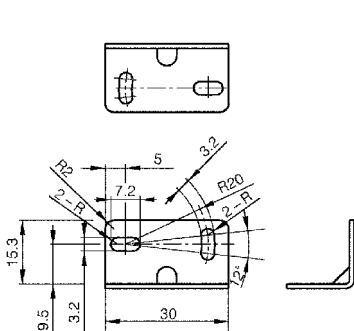



**HPA-B02 mounting bracket for vertical model\***

\*Sold separately. Cannot be used for a connector model.

(unit: mm)

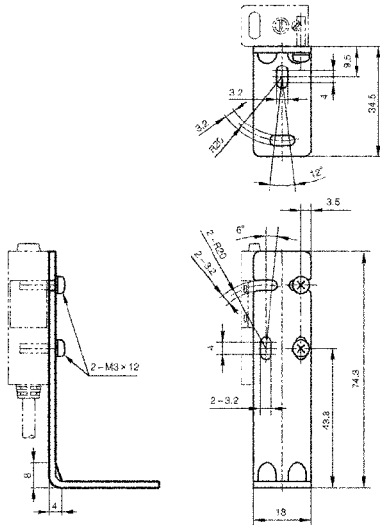

**HPA-B03 wraparound mounting bracket\***

\*Sold separately. Cannot be used for a connector model.

Horizontal mounting

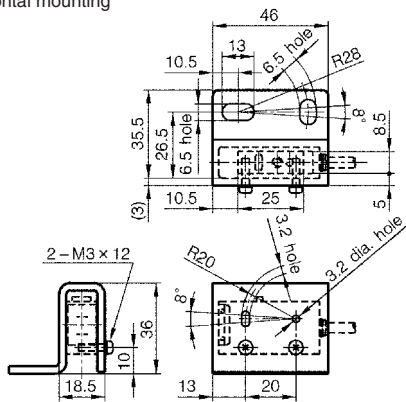

Vertical mounting

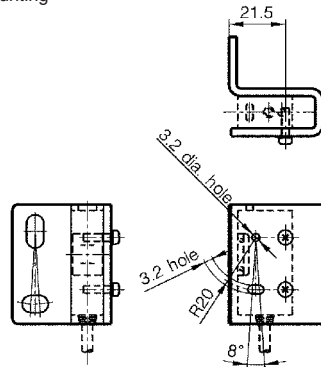

**● Reflector**

FE-RR8 reflector (sold separately)

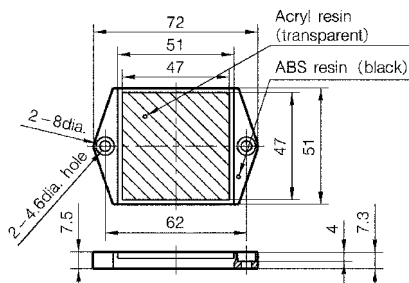

FE-RR15 small reflector (sold separately)

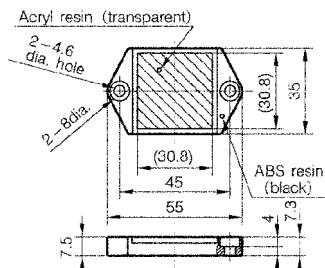

## COMPONENT NAMES

● **Advanced function thru scan receiver**  
Advanced function polarized retroreflective model

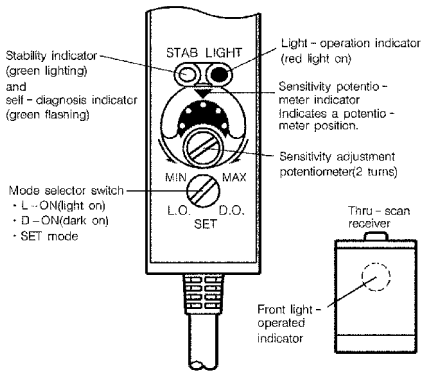

● **General use thru scan receiver**  
General use polarized retroreflective and diffuse scan models

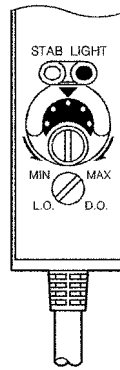

● **Advanced function thru scan emitter**

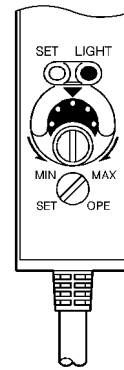

## TRIPLE ALIGNMENT FUNCTION (for initial setup)

Switch the mode selector switch to the SET position, and the system will enter the advanced-function mode. The three functions listed below are concurrently available.

### 1. Strobe Light Emission Function

A narrow beam strobe light with twice the usual luminosity.

### 2. High Margin Regulating Function

This function halves the quantity of light emitted. Use it in environments where the emitted light may not be transmitted reliably at normal levels. When switched back to the normal mode, the emitter generates triple the usual amount of light.

### 3. Output Suppression Function

Output is forced OFF irrespective of the sensor's ON/OFF status.

#### ⚠ Important points to note

For thru scan models, a mode selector switch is built into both the emitter and receiver. When the mode selector switch on the emitter side is thrown to the SET position, the strobe light emission function and high margin regulating function modes are set. When the switch on the receiver side is thrown to the SET position, the output suppression function mode is set. Note that the L-ON mode may momentarily occur when throwing the mode selector switch from one position to the other. After completion of the optical axis adjustment or after maintenance, change the SET mode back to normal mode.

**Allegheny Electronics**

1301 Potomac Ave.

Hagerstown, MD 21742

TEL 800-296-6460 301-739-6460

FAX 800-296-7674 301-739-5311

www.alleghenyelectronics.com

## OUTPUT CIRCUIT DIAGRAM

### ● NPN type

Thru scan receiver, polarized retroreflective and diffuse scan models

Without self-diagnostic output

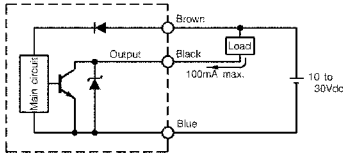

With self-diagnostic output

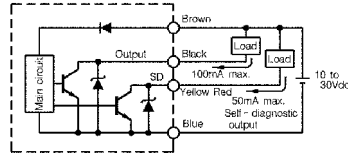

Thru scan emitter

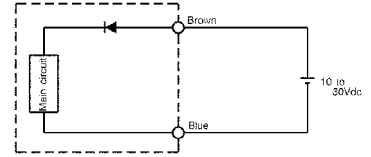

### ● PNP type

Thru scan receivers, polarized retroreflective and diffuse scan models

Without self-diagnostic output

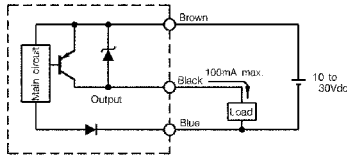

With self-diagnostic output

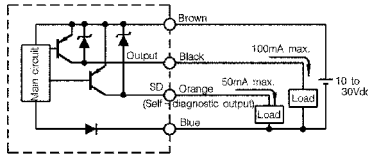

Thru scan emitter

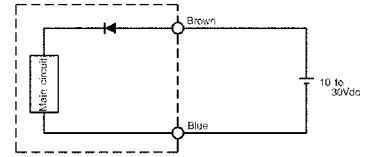

## WIRING DIAGRAM

### ● Preloaded models

Thru scan emitter

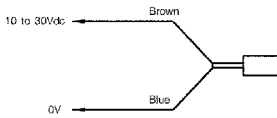

Thru scan receiver, polarized retroreflective and diffuse scan models

(When a load is directly applied)

NPN type

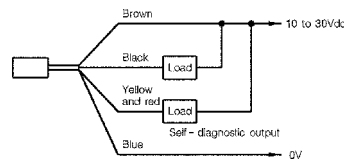

PNP type

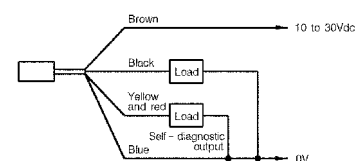

(When a voltage input device is connected)

NPN type

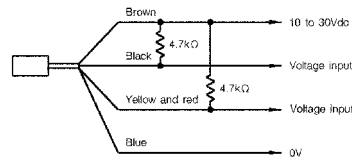

PNP type

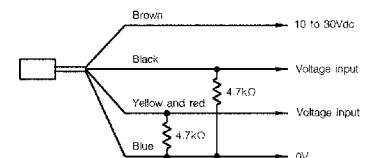

### ● Connector and preloaded connector models

Thru scan emitter

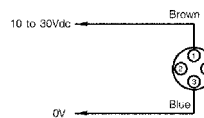

Thru scan receiver, polarized retroreflective and diffuse scan models

NPN type

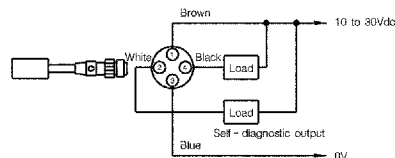

PNP type

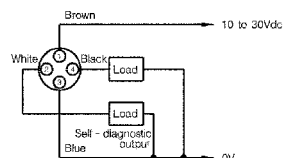

Note: Lead colors match the Yamatake PA5 Series cable with connector.

Allegheny Electronics - 1301 Potomac Ave. - Hagerstown, MD 21742

TEL 800-296-6460 301-739-6460 - FAX 800-296-7674 301-739-5311 - www.alleghenyelectronics.com

## TIMING CHARTS FOR OUTPUT AND INDICATORS

The HPA's self-diagnostic output and indicators latch ON when there is:

- ① insufficient incoming light (due to a decrease in the quantity of light caused by dirt, etc.)
- ② incompletely blocked light (due to irregular position of a workpiece, etc.). They latch in either dark-ON (D.O.) or light-ON (L.O.) mode.

### ● Diagnosis for L.O. operation

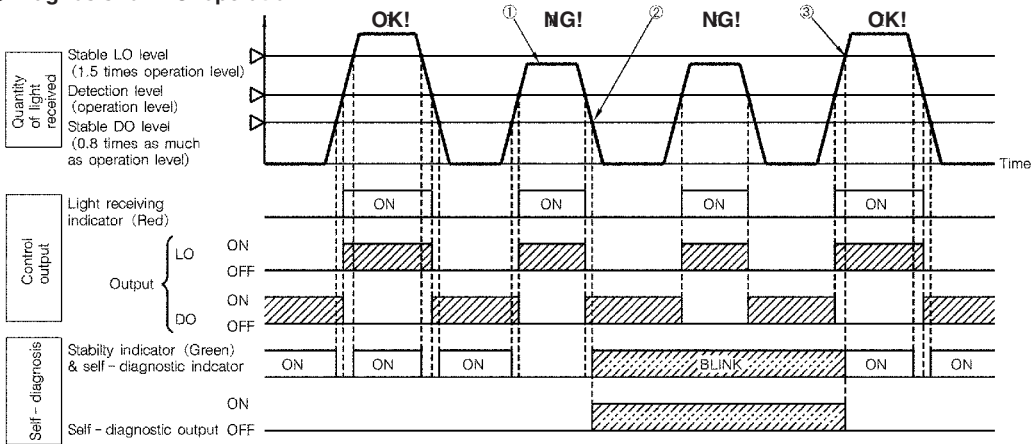

Ⓐ: The incoming light is sufficient for correct operation

Ⓑ: Incoming light is insufficient, making the self-diagnostic output and indicator go ON.

#### \*Explanation of timing charts:

1. If the photoelectric sensor returns to the stable D.O. level (above, ①) without reaching the stable L.O. state (②) after the photoelectric sensor operates, the self-diagnostic output will latch ON and the stability indicator will start blinking.
2. Afterwards, the self-diagnostic output will go OFF, the latch will be cancelled, and the stability indicator will stop blinking when the quantity of light received reaches the stable L.O. level (③).

### ● Diagnosis for D.O. operation

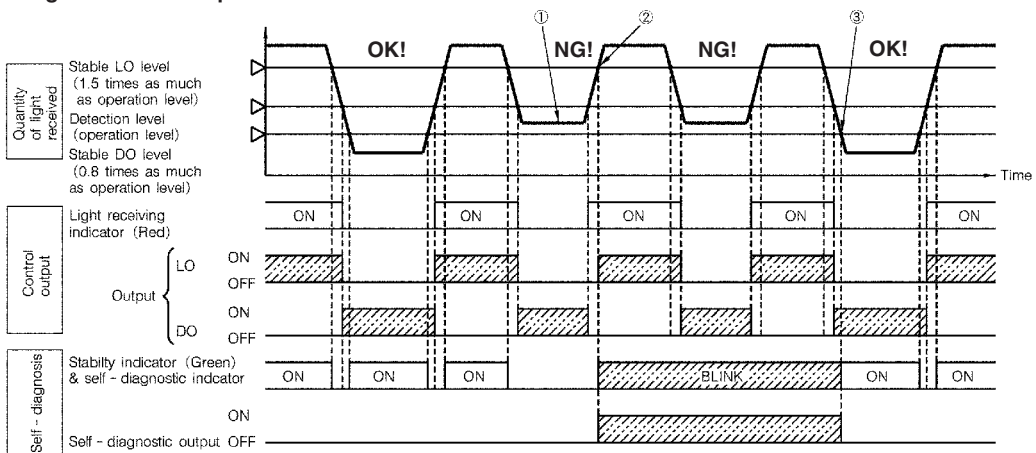

Ⓐ: The incoming light is sufficient for correct operation

Ⓑ: Incoming light is insufficient, making the self-diagnostic output and indicator go ON.

#### \*Explanation of timing charts:

1. If the photoelectric sensor returns to the stable L.O. level (above, ) without reaching the stable D.O. state (②) after the photoelectric sensor operates, the self-diagnostic output will latch ON and the stability indicator will start blinking.
2. Afterwards, the self-diagnostic output will go OFF, the latch will be cancelled, and the stability indicator will stop blinking when the quantity of light received reaches the stable D.O. level (③).

⚠ Caution regarding a situation that may not be diagnosed:  
Control output may be inverted in an unstable L.O. and D.O. state.

When a workpiece that is only slightly distinguished by the quantity of reflected of light is scanned, such as a transparent body, the quantity of light received may neither fall to the stable D.O. level nor rise to the stable L.O. level. In this case, neither the self-diagnostic output nor the indicating lamps go ON. (There is no indication or output unless ①, for L.O. diagnosis, the light level falls to the stable D.O. level, or ②, for D.O. diagnosis, the light level rises to the stable L.O. level.)

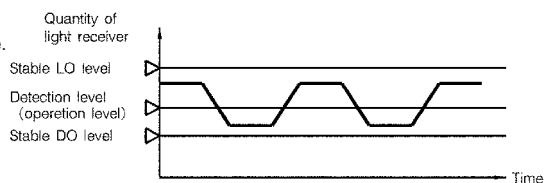

## SENSITIVITY ADJUSTMENT

### Thru scan models

Adjust the optical axis and sensitivity until the indicators light in the following two conditions:

<b>1</b>		Green <input type="radio"/> ON Red <input type="radio"/> OFF (Stable L.O.)
<b>2</b>		Green <input type="radio"/> ON Red <input checked="" type="radio"/> ON (Stable L.O.)

### Polarized retroreflective models

Basically, the adjustment is the same as thru scan models.

<b>1</b>		Green <input type="radio"/> ON Red <input type="radio"/> OFF (Stable L.O.)
<b>2</b>		Green <input type="radio"/> ON Red <input checked="" type="radio"/> ON (Stable L.O.)

### Polarized retroreflective models

Work sequence	Placement of target object	Sensitivity adjustment potentiometer	Indicators	Adjustment
<b>1</b>			Green <input type="radio"/> ON Red <input type="radio"/> OFF	With the target in position, turn the potentiometer counterclockwise from MAX until the red indicator goes off. This is point ①. If the red light is already off at MAX, MAX is point ①.
<b>2</b>			Green <input type="radio"/> OFF Red <input checked="" type="radio"/> ON	With no target object present, turn the potentiometer clockwise from MIN to find point ② where the red indicator turns on.
<b>3</b>			Green <input type="radio"/> OFF Red <input type="radio"/> OFF (Stable L.O.) Green <input checked="" type="radio"/> ON Red <input checked="" type="radio"/> ON (Stable L.O.)	Set the sensitivity potentiometer halfway between positions ① and ②. This is the optimal setting. Note: If the potentiometer has been turned completely once or more, make adjustment on the basis of the position of the indicator.

### Diffuse scan models

Work sequence	Placement of target object	Sensitivity adjustment potentiometer	Indicators	Adjustment
<b>1</b>			Green <input type="radio"/> ON Red <input type="radio"/> OFF	With no target object present, turn the potentiometer counterclockwise from MAX until the red indicator goes off. This is point ①. If the red light is already off at MAX, MAX is point ②.
<b>2</b>			Green <input type="radio"/> ON Red <input checked="" type="radio"/> ON	With the target object in position, turn the potentiometer clockwise from MIN to find point ② where the red indicator turns on.
<b>3</b>			Green <input type="radio"/> ON Red <input type="radio"/> ON (Stable L.O.) Green <input checked="" type="radio"/> ON Red <input checked="" type="radio"/> OFF (Stable L.O.)	Set the sensitivity potentiometer halfway between positions ① and ②. This is the optimal setting. Note: If the potentiometer has been turned completely once or more, make adjustment on the basis of the position of the indicator.

**Allegheny Electronics - 1301 Potomac Ave. - Hagerstown, MD 21742**

**TEL 800-296-6460 301-739-6460 - FAX 800-296-7674 301-739-5311 - www.alleghenyelectronics.com**

## CONNECTOR SPECIFICATIONS \*1

Item	Specifications
Insulation resistance	Max. 100MΩ (by 500Vdc megger)
Dielectric strength	1,500Vac for 1 minute (between contacts, and between contact and connector housing)
Initial contact resistance	Max. 40mΩ (with 3A current to connected male and female connectors. Semiconductor lead-specific resistance not included.)
Mating/unmating force	0.4 to 4.0 N per contact
Mating cycles	50
Connector nut tightening torque	Min. 0.8N·m*2
Cable pullout strength	Min. 100 N
Vibration resistance	10 to 55Hz, 1.5mm peak-to-peak amplitude, for 2 hours each in X, Y and Z directions
Impact resistance	300m/s <sup>2</sup> , 3 times each in X, Y and Z directions
Protective structure	IP67
Ambient operating temperature	-10 to +70°C
Ambient storage temperature	-20 to +80°C
Ambient operating humidity	Max. 95% RH
Material	Contacts: Gold-plated brass Contact holder: Glass-lined polyester resin Housing: Polyester elastomer Coupling: Ni-plated brass O-ring: NBR

\*1: Specifications assume Yamatake male/female connectors.

\*2: The recommended torque is 0.4 to 0.6N·m. If fastened poorly, the IP67 protection is lost, or looseness occurs. Fasten the connector securely by hand.

## CABLE WITH CONNECTOR

Be sure to use a PA5 Series cable with connector when connecting a preleaded connector or connector-type sensor.

### ● PA5 Series cable with connector

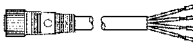
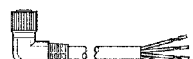
Shape	Power supply	Cable properties	Cable length	Catalog listing	Lead colors
	DC	Oil-resistant, flexible; UL2464; flame-resistant; EN-compliant	2m	PA5-4ISX2MK-E	1: brown, 2: white, 3: blue, 4: black
			5m	PA5-4ISX5MK-E	1: brown, 2: white, 3: blue, 4: black
			2m	PA5-4ILX2MK-E	1: brown, 2: white, 3: blue, 4: black
			5m	PA5-4ILX5MK-E	1: brown, 2: white, 3: blue, 4: black

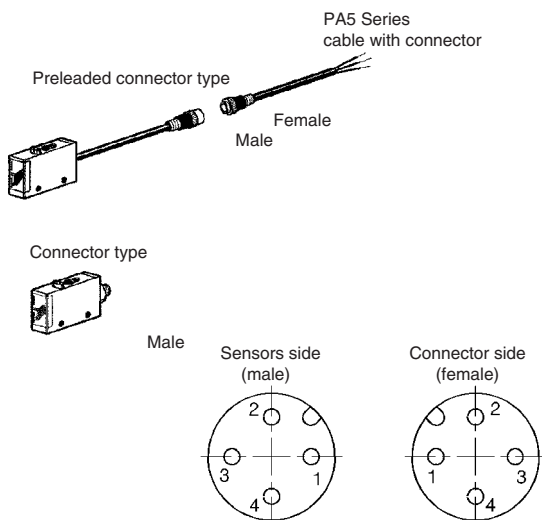

### ● Tightening the connector

Align the grooves and rotate the fastening nut on the PA5 connector by hand until it fits tightly with the connector on the sensors side.

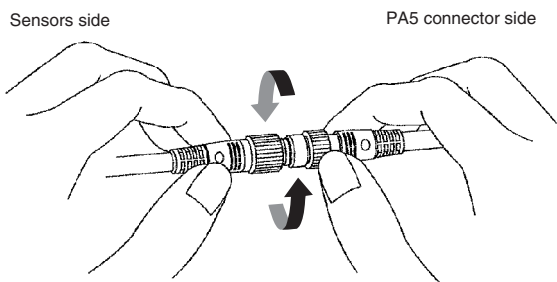

**Allegheny Electronics - 1301 Potomac Ave. - Hagerstown, MD 21742**  
**TEL 800-296-6460 301-739-6460 - FAX 800-296-7674 301-739-5311 - www.alleghenyelectronics.com**

## PRECAUTIONS FOR USE

### 1. Wiring

- Be sure to connect the photoelectric sensor to its power supply and load correctly.
- If there is a high-voltage or power cable near the photoelectric sensor cable, route the sensor cable separately or put it in a separate conduit to prevent surge and noise influence.
- Connect the lead ends securely using crimp terminals.
- If extending the cable, use wire at least 0.3mm<sup>2</sup> in cross-sectional area. The length should not exceed 100m. Consider the effects of increased electrical noise due to cable extension.
- If a switching regulator is used, ground its frame.
- If a capacitive load is used, connect a current-limiting resistor to limit inrush current to 100mA max.

### 2. Handling

- Do not swing a photoelectric sensor by its cable.
- Do not pull the cable of a photoelectric sensor with excessive force. The pullout strength is 49N max.
- Do not strike or scratch the sensing head.
- Do not use a photoelectric sensor outdoors, in environments where chemicals (organic solvent, acid, alkali) are present, or where water or oil may splash onto the sensor.
- Fasten connectors firmly by hand.
- Do not bend the cable beyond the bend radius of 30mm.

### 3. Polarized retroreflective model

The polarized retroreflective model uses a light-polarizing filter, and employs a detection method intended to prevent reflection from mirror surfaces or shiny detection objects. For this reason, malfunction may occur when the characteristics of the target object are such that its surface polarizes light. Check this before use.

Examples:

Target objects covered in transparent film

Mirror surfaces with slight surface unevenness, or shiny target objects.