

# BRECO *flex* CO., L.L.C.

High Precision Drive Components



ESBAND TRULY ENDLESS WOVEN FLAT BELTS

B210



## TRULY ENDLESS FLAT BELTS DEFINED:

ESBAND truly endless homogeneous flat belts are manufactured without joints or splices for high-performance drive and conveying applications. These unique flat belts offer many advantages and benefits for demanding drive and conveying machinery and equipment. ESBAND endless belt technology outperforms conventional joined flat belt designs.

## CHARACTERISTICS

- **Homogeneous**  
Uniform elongation, tear resistance and thickness tolerances over the entire belt length – weak points are eliminated
- **Flexible**  
Reliable for frequent back bending. Also suited for very small pulley and shaft diameters as well as knife edges.
- **Quiet running**  
Low noise level due to truly endless design (no joints)
- **Reduced preload**  
The bipolar design: Low longitudinal elongation and high transverse flexibility result in reduced pretension and low shaft loading
- **Customized**  
Wide selection of materials for carcass and covers allows for customer specific belt configurations to meet unique needs

## PRODUCTS & PROPERTIES

- **Drive belts**  
High running accuracy, low vibration, flexible
- **Standard Conveyor belts**  
Tear-resistant, elastic, customized
- **Weighing belts**  
Homogeneous, constant weight, reliable
- **Vacuum conveyor belts**  
Precise, perforated, customized
- **Food transport belts**  
Easy to clean, temperature resistant
- **High temperature belts**  
Reliable in temperature ranges up to 300°C
- **Machine and process belts**  
Robust, reliable, durable
- **Special belts (to customer's specifications)**  
Diverse, unique, solution-oriented
- **Conveyor belts for paper transport and paper handling**  
Abrasion-resistant, ozone-resistant, customized
- **Coating materials for timing and Multi-V belts**  
Application specific, innovative

All recommendations for the use of the products described herein and all other data or information set forth in this publication, whether concerning such products or otherwise, are furnished without any guarantee, warranty representations or inducement of any kind whether express or implied, including but not limited to warranties of merchantability and fitness for a particular purpose.

## ADVANTAGES

- **Highly efficient**  
(> 98.5%)
- **Belt speeds of 150 m/s possible**
- **Long service life**
- **High loads possible**  
(up to 30 kW/cm)
- **Good dynamic characteristics**
- **Improved shock absorption**
- **Can be used as overload protection**

## TABLE OF CONTENTS

<b>General Information</b>	
Drives . . . . .	.3
Conveying . . . . .	.3
Carcass Materials . . . . .	.4
Coating Materials . . . . .	.5
Coefficients of Friction . . . . .	.6
Special Processing . . . . .	.7
<b>Technical Specifications</b>	
Polyurethane . . . . .	.8
Neoprene . . . . .	.10
FX-Polyurethane / Silicone / PVC . . . . .	.12
<b>Design Considerations</b>	
Design Considerations . . . . .	.14
Drive Layout . . . . .	.15
Belt Sizing . . . . .	.16
Duty Cycle . . . . .	.16
Power and belt speed . . . . .	.16
Bending frequency . . . . .	.17
Special drive designs . . . . .	.17
<b>Belt Examples</b>	
Belt Examples . . . . .	.18

BRECOflex CO., L.L.C. expressly disclaims liability under any theory, including without limitation, contract negligence, misrepresentation or breach of any obligation relating to the recommendation, data or information set forth herein. Readers and customers are encouraged to conduct their own test before using any product. Read its label and all related instructions.

## DRIVES

ESBAND belts are manufactured as truly endless woven flat belts to provide high efficiency, precise running, low vibration, low noise and long life even at high belt speeds and bending frequencies.

### 1. Two Pulley Drives

- Power transmission with low shaft loads and minimal wear
- Power transmission of up to 60 kW (special versions up to 150 kW)
- Temperature range up to 130°C
- Absorption of shock and vibration
- Suitable for overload protection
- High reliability and efficiency

### 2. Perpendicular Belt Drives

- Ideal solutions for right angle drives

### 3. Crossed Belt Drives

- Simple designs for changing the running direction of shaft (Crossed Belt Drives) or shaft position (Half-Crossed Belt Drives)

### 4. Serpentine Drives

- Long life at high belt speeds and bending frequencies

### 5. Spindle Drives

- Spindle tapes and tangential drives in the textile industry
- Especially suited for very small shaft diameters and high belt speeds

### Light-Duty Drives up to 2.5 kW

Wear resistant belts with superior running and traction properties, high flexibility, well defined coefficients of friction, antistatic.

Typical applications:

- High-speed drives
- Office equipment
- Household appliances
- Power tools
- Grinding machines
- Saws
- Testing equipment
- Spindle drives
- Spinning frames
- Bobbin machines
- Textile machinery

### Medium-Duty Drives up to 15 kW

Wear resistant belts with superior

running and traction properties, low noise, low elongation, antistatic.

Typical applications:

- High-speed drives
- Woodworking machinery
- Floor maintenance equipment
- Grinding machines
- Machine tools
- Textile machinery
- Construction equipment

### Heavy-Duty Drives up to 60 kW

Highly wear resistant belts with good traction properties, low elongation and smooth running.

Typical applications:

- Balancing equipment
- Construction machinery
- Stamping presses
- Woodworking machinery
- Fan drives
- Engine test benches
- Turbine drives
- Hydro-electric power plants
- Mills
- Testing equipment

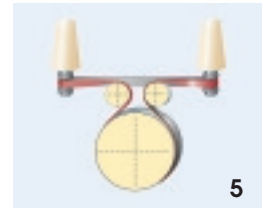
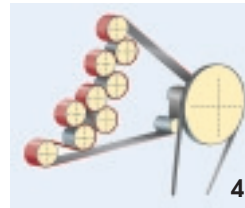
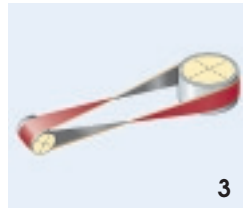
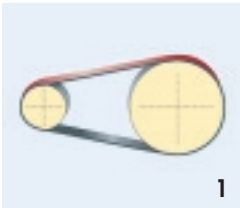

## CONVEYING

ESBAND truly endless woven conveyor belts are available in many carcass materials with different coatings to meet the required coefficient of friction for a specific application. The most common types of conveying applications are as follows.

### Paper

For paper processing and paper handling ESBAND offers belts with various degrees of elasticity (supported and unsupported), high ozone-resistance, high break strength and low elongation, based on specific needs. Typical applications: printing machines, copiers and scanners, ATMs and ticket dispensing equipment as well as paper and cardboard converting machines.

### Food

ESBAND truly endless woven conveyor belts allow delicate processing and packaging of food. The belts are easy to clean and temperature-resistant with various degrees of elasticity, flexibility and coefficients of friction.

Typical applications: transfer stations, automatic packaging machines, cheese processing machines, bakery equipment and knife edges.

### Weighing technology

ESBAND truly endless woven conveyor belts are homogeneous over the entire belt width and length (including weight). All coating and elongation characteristics are consistent throughout the belt. Special surface finishes and low friction covers are applied evenly across the belt. The uniformity of ESBAND truly endless woven flat belts makes them the perfect choice for weighing equipment. Typical applications: light weight bulk material handling, dynamic weighing devices and small shaft diameters.

### Bulk Material and Unit Goods

ESBAND truly endless woven flat belts convey every type of unit goods and bulk material of all weights and sizes to perfection. The belts are easy to clean

and temperature-resistant with various degrees of elasticity and flexibility and well defined coefficients of friction.

Typical applications: speed-up conveyors, vacuum conveyors, fixed shaft centers and knife edges.

### Special Conveyor Belts

ESBAND supplies truly endless woven conveyor belts with special surface treatments to convey unit goods and bulk materials in extreme conditions. Typical applications: incline conveyors, synchronous and vacuum conveyors, sharp inclines and extended temperature ranges.

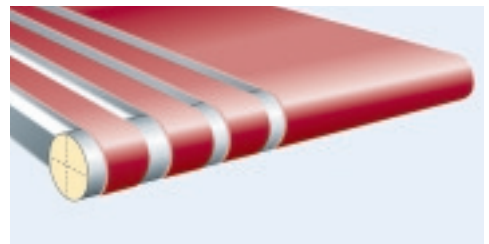

# Carcass Materials

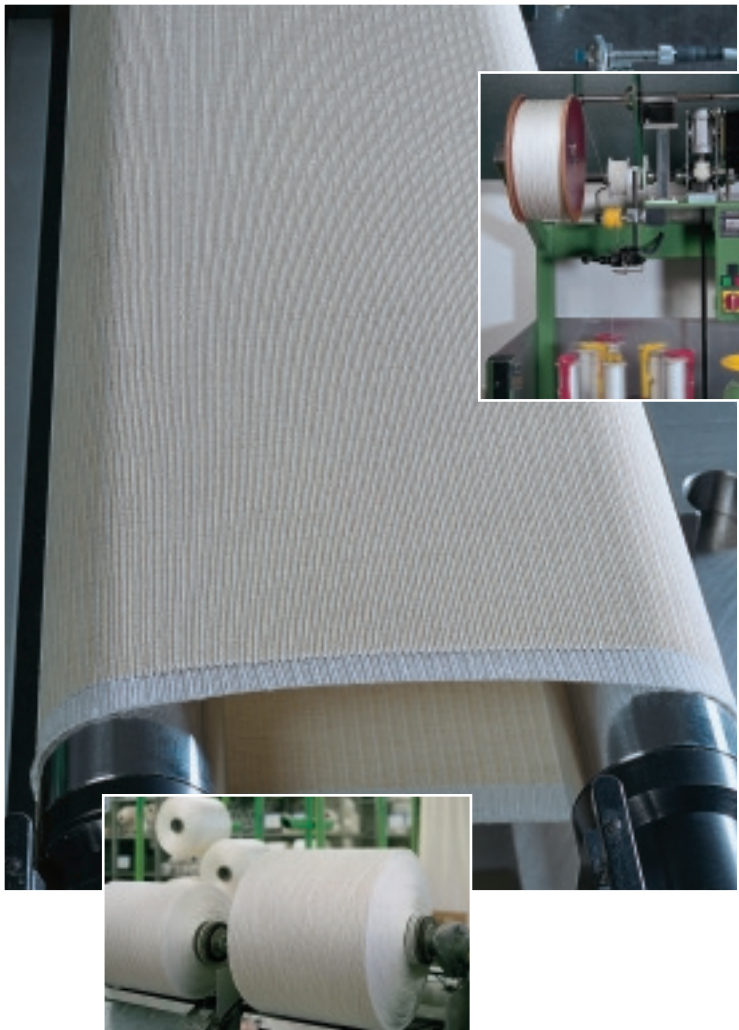

ESBAND flat belt carcasses are produced in truly endless form by using high tech weaving machines. These specialty carcasses are the belt bases for further processing, coating and treatment.

Various carcass materials are used for specific belt characteristics.

## Available carcass materials

### Elastic yarn

- High elasticity, elongation from 4 – 10%
- For fixed shaft centers
- No tensioning devices necessary

### Kevlar®

- Extremely low elasticity
- Low coefficient of friction
- Temperature range up to 280°C

### Polyamide

- Medium elasticity, elongation from 0.5- 1.5%
- For fixed shaft centers

### Nomex

- Low elasticity
- Temperature range up to 300°C

### Polyester

- Low elasticity
- Chemical-resistant

### Fiberglass

- Low elasticity
- Low coefficient of friction
- Temperature range up to 300°C

### Cotton

- Low elasticity
- Low coefficient of friction

## Carcass Material Chemical Compatibility Chart

Chemicals	Carcass materials					
	Polyester	Cotton	Nomex	Fiberglass	Kevlar®	
Water	+	+	+	+	+	High = +
Oils, Greases	+	○	+	+	+	
Diluted Acids	+	+	+	+	+	
Diluted Bases	○	+	+	+	+	Medium = ○
Aromatics - Benzene based	+	+	+	+	+	Low = -
Alcohol	+	+	+	+	+	
Aliphatic compounds	+	+	+	+	+	
Ether	+	+	+	+	+	
Chlorinated hydrocarbons	+	+	+	+	+	
<b>Dimensional stability</b>						
at high humidity	+	-	+	+	+	
with highly fluctuating temperatures	+	+	+	+	+	

All ESBAND coatings are applied as endless covers so belts may be run in either direction. In addition polyurethane timing belts can be coated using the same materials.

## Available coating materials

### Polyurethane (PU)

- Foamed (yellow, gray, white, red)
- Compact (white, FDA)
- Temperature range up to 60°C (intermittent up to 80°C)
- Good coefficient of friction to paper
- Different durometers available
- Thickness up to 10 mm

### Natural Rubber (NK)

- Red (durometer approx. 42 Shore A)
- Maroon (durometer approx. 50 Shore A)
- High coefficient of friction
- Temperature range up to 70°C
- High elasticity
- Low tear propagation

### Neoprene Rubber (NE)

- Black (durometer approx. 75 Shore A)
- Good abrasion resistance
- High coefficient of friction
- Good resistance to oils, greases, ozone
- Temperature range up to 100°C
- High flexibility
- Antistatic

### NBR Rubber (NBR)

- Light gray, blue, white
- White (FDA)
- Good abrasion resistance
- High coefficient of friction
- Very good resistance to oils and greases
- Temperature range up to 100°C

### xNBR Rubber (xNBR)

- Off-white (durometer approx. 75 Shore A)
- Good abrasion resistance
- High coefficient of friction
- Ozone-resistant
- Good resistance to oils and greases
- Temperature range up to 130°C

### Silicone (SI, HN, HG, HK)

- White, gray (durometer approx. 30 – 35 Shore A)
- Thickness up to 10 mm
- Temperature range up to 280°C
- High coefficient of friction
- Stain resistant
- FDA
- Resistant to adhesives

### PVC (PC)

- Red
- Temperature range up to 60°C
- Good resistance to chemicals

### EPDM

- Green (durometer approx. 65 Shore A)
- Very good resistance to weather aging
- Temperature range up to 80°C
- High coefficient of friction

## Coating Material Chemical Compatibility Chart

Chemicals	Coating materials					
	Polyurethane (PU)	Neoprene (NE)	Silicone (SI)	PVC (PC)	NBR/xNBR	
Water	○	+	+	+	+	High = +
Oils, Greases	+	+	○	○	+	
Diluted Acids	-	+	○	+	○	Medium = ○
Diluted Bases	-	+	○	+	+	
Aromatics - Benzene based	○	-	-	-	-	Low = -
Alcohol	○	+	+	○	+	
Aliphatic compounds	+	+	○	+	+	
Ether	○	+	-	-	○	
Chlorinated hydrocarbons	○	+	-	-	-	

# Coefficients of Friction

Various coating materials along with several surface finishes offer a wide range of coefficients of friction both on the running and the carrying side. Almost all combinations of coatings are available.

## Coefficients of friction in clean, unused condition

Measured on ground or smooth surfaces; all values  $\mu \pm 0.1 \mu$

ESBAND Coating / Surface Finishes	Steel	Aluminum	Aluminum Anodized	Cast Iron	Stainless Steel	UHMW	PETP White	Paper	PE Foil
NE textured	0.6	0.4	0.6	0.5	0.6	0.3	0.6	0.8	0.2
NE ground	0.5	0.5	0.6	0.7	0.5	0.3	0.7	0.8	0.3
NE smooth	0.6	0.6	0.8	> 0.9	0.6	0.4	0.8	0.9	0.9
PU ground	0.4	0.4	0.8	0.4	0.3	0.2	0.6	0.8	0.2
PU soft, ground	0.4	0.4	0.9	0.5	0.3	0.2	0.5	0.8	0.2
PU non-porous	0.3	0.5	0.6	0.8	0.3	0.2	0.4	0.5	0.2
PU low-friction coating	0.2	0.3	0.7	0.4	0.2	0.2	0.4	0.6	0.2
SI ground	0.4	0.4	0.6	0.5	0.3	0.2	0.3	0.6	0.3
SI skim coat	0.7	0.8	0.9	0.8	0.5	0.4	0.8	0.9	> 0.9
PVC textured	0.7	0.8	> 0.9	0.9	0.6	0.4	0.8	0.9	0.5
PVC smooth	0.6	0.8	0.9	0.8	0.5	0.4	0.8	0.9	> 0.9
FX ground	0.4	0.3	0.4	0.5	0.2	0.2	0.4	0.7	0.1
FX smooth	0.5	0.4	0.5	0.6	0.4	0.1	0.2	0.4	0.9
FX structured	0.3	0.4	0.5	0.5	0.2	0.1	0.4	0.6	0.1
NK red or maroon ground	0.8	0.8	0.6	0.9	0.6	0.7	0.6	0.8	0.7
NBR smooth, textured, ground	0.4	0.4	0.4	0.5	0.3	0.3	0.4	0.5	0.8
NBR blue textured, ground	0.4	0.4	0.9	0.5	0.4	0.2	0.6	0.8	0.2
xNBR off-white textured, ground	0.3	0.4	0.5	0.4	0.3	0.2	0.5	0.6	0.2
EPDM smooth	0.8	> 0.9	> 0.9	0.9	> 0.9	> 0.9	> 0.9	0.9	> 0.9
EPDM ground, 80-grain	0.9	> 0.9	> 0.9	0.9	0.9	> 0.9	> 0.9	0.9	0.3
EPDM ground, 150-grain	0.9	> 0.9	> 0.9	0.9	0.9	> 0.9	> 0.9	0.9	0.4
Carcass raw polyester, Kevlar®	0.2	0.2	0.3	0.2	0.2	0.1	0.2	0.3	0.1
Carcass raw fiberglass	0.2	0.2	0.3	0.2	0.2	0.1	0.2	0.3	0.1
Carcass raw cotton	0.1	0.2	0.3	0.2	0.1	0.1	0.2	0.3	0.1
Carcass NE impregnated	0.2	0.2	0.3	0.2	0.2	0.1	0.2	0.4	0.2



All ESBAND products are truly endless flat belts manufactured to exacting standards to meet specific application requirements.

ESBAND can accommodate custom designs. Perforations, vacuum slots and transport pockets are manufactured using a 5-axis, computer controlled machine to meet specific application requirements.

The following are examples of the many possible machined belt configurations

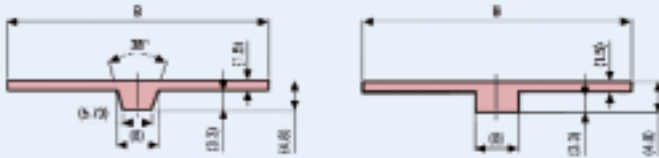

### Flat Belts with Self-Tracking Guides

- Guides are either bonded to the flat belt or milled from solid material

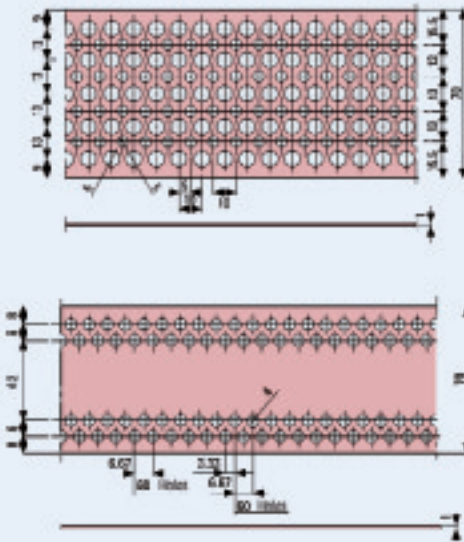

### Flat Belts with Perforations

- Hole diameters from 1.5 to 10 mm
- Perforation patterns according to specific requirements
- Non-standard holes possible

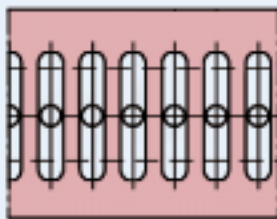

### Flat Belts with Heavy Coating and Vacuum Holes

- Suction slots increase the vacuum surface area

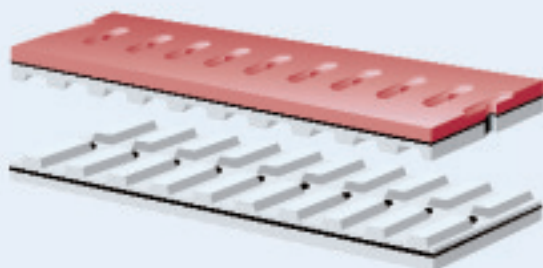

### Polyurethane Timing Belts with Coating

- Vacuum holes and suction slots for Form-Fill-Seal applications

PU Type	Surface Versions	Carcass Materials	Coating/ Hardness*	Colors	Break Strength per cm Endless Belt (Shaft Load)
<b>PU 0/6</b>	- see table on page 9 for all possible surface versions	without carcass	Polyurethane 55±7 Shore A	yellow, gray, white, red	140 N
<b>PU elastic</b>	- see table on page 9 for all possible surface versions	Rubber cords/ Cotton	Polyurethane 55±7 Shore A	yellow, gray, white, red	250 N
<b>PU elastic + SI carrying side</b>	- ground on one side, silicone on other side - non-porous ply on one side, silicone on other side - low-friction coating on one side, silicone on other side	Rubber cords/ Cotton	Polyurethane 55±7 Shore A Silicone 30±5 Shore A	PU = yellow, gray, white, red SI = white, gray	300 N
<b>PU elastic 13</b>	- see table on page 9 for all possible surface versions	Rubber cords/ Cotton	Polyurethane 55±7 Shore A	yellow, gray, white, red	200 N
<b>PU 4/6</b>	- see table on page 9 for all possible surface versions	Polyester	Polyurethane 55±7 Shore A	yellow, gray, white, red	650 N
<b>PU 10</b>	- see table on page 9 for all possible surface versions	Polyester/ Polyamide	Polyurethane 55±7 Shore A	yellow, gray, white, red	700 N
<b>PU 11</b>	- see table on page 9 for all possible surface versions	Polyester	Polyurethane 55±7 Shore A	yellow, gray, white, red	1250 N
<b>PU 12</b>	- see table on page 9 for all possible surface versions	Polyester	Polyurethane 55±7 Shore A	yellow, gray, white, red	3400 N
<b>PU 17</b>	- see table on page 9 for all possible surface versions	Kevlar®	Polyurethane 55±7 Shore A	yellow, gray, white, red	2400 N
<b>PU 18</b>	- see table on page 9 for all possible surface versions	Kevlar®	Polyurethane 55±7 Shore A	yellow, gray, white, red	6400 N
<b>PU 20/1</b>	- see table on page 9 for all possible surface versions	Polyester/ Cotton	Polyurethane 55±7 Shore A	yellow, gray, white, red	1150 N
<b>PU 20</b>	- see table on page 9 for all possible surface versions	Polyester/ Cotton	Polyurethane 55±7 Shore A	yellow, gray, white, red	850 N



P	Belt Elongation in % per cm Belt Width (Shaft Load)			Required Shaft Load for 1% Elongation per cm Belt Width	Minimum Pulley Diameter	Temperature Range		Recommended Pre-Tension	Antistatic
						Continuous	Intermittent		
	10 N 8.5 - 9.5%	20 N 33 - 35%	30 N 72 - 76%	4 ± 2 N	8 mm	-10 to + 60°C	-10 to + 80°C	4% - 8%	no
	10 N 1.8 - 3.1%	20 N 5.2 - 8.2%	30 N 9.5 - 13%	6 ± 3 N	25 mm	-10 to + 60°C	-10 to + 80°C	4% - 8%	possible
	10 N 1.9 - 2.1%	20 N 5.8 - 6.2%	30 N 9.6 - 10%	9 ± 3 N	30 mm	-10 to + 60°C	-10 to + 80°C	4% - 8%	possible
	10 N 1.9 - 2.1%	20 N 5.8 - 6.2%	30 N 9.6 - 10.4%	8 ± 2 N	25 mm	-10 to + 60°C	-10 to + 80°C	4% - 8%	possible
	30 N 0.1 - 0.2%	100 N 0.6 - 0.8%	300 N 3.3 - 3.7%	130 ± 15 N	9 mm	-10 to + 60°C	-10 to + 80°C	0.4% - 0.8%	possible
	30 N 0.2 - 0.3%	60 N 0.5 - 0.6%	100 N 0.9 - 1.2%	100 ± 15 N	8 mm	-10 to + 60°C	-10 to + 80°C	1.2% - 1.5%	possible
	100 N 0.3 - 0.5%	300 N 1.2 - 1.7%	600 N 5.0 - 5.5%	230 ± 30 N	12 mm	-10 to + 60°C	-10 to + 80°C	0.4% - 0.8%	possible
	100 N 0.3 - 0.5%	300 N 0.9 - 1.2%	600 N 2.0 - 2.8%	290 ± 30 N	20 mm	-10 to + 60°C	-10 to + 80°C	0.4% - 0.8%	possible
	300 N 0.2 - 0.4%	600 N 0.5 - 0.7%	1000 N 1.0 - 1.2%	950 ± 50 N	15 mm	-10 to + 60°C	-10 to + 80°C	0.1% - 0.3%	possible
	300 N 0.4 - 0.5%	600 N 0.7 - 0.8%	1000 N 0.9 - 1.0%	1280 ± 50 N	30 mm	-10 to + 60°C	-10 to + 80°C	0.1% - 0.3%	possible
	30 N 0.1 - 0.2%	100 N 0.5 - 0.7%	300 N 2.1 - 2.6%	165 ± 15 N	9 mm	-10 to + 60°C	-10 to + 80°C	0.4% - 0.8%	possible
	30 N 0.1 - 0.2%	100 N 0.5 - 0.7%	300 N 2.1 - 2.6%	165 ± 15 N	5 mm	-10 to + 60°C	-10 to + 80°C	0.4% - 0.8%	possible

PU Properties	Standard Manufacturing Dimensions (mm)**			Standard Tolerances**		
	Length	Width	Thickness (max.)	Length	Width	Thickness
- highly elastic - friction lining - for fixed shaft centers - belts used as sets	200 - 600 600 - 2400	up to 300 up to 400	0.9 1.2 (from 1000mm) 1.5 (from 1500mm) 2.0 (from 2000mm) (8.0)	± 2.0%	up to 50 mm = ± 0.5 mm up to 100 mm = ± 1.0 mm over 100 mm = ± 2.0 mm	± 0.10mm
- elastic - for fixed shaft centers - belts used as sets	200 - 600 600 - 3500	up to 300 up to 600	1.8 (9.0)	± 2.0%	up to 50 mm = ± 0.5 mm up to 100 mm = ± 1.0 mm over 100 mm = ± 2.0 mm	± 0.10mm
- elastic - for fixed shaft centers - different values of coefficient of friction - belts used as sets	200 - 600 600 - 3500	up to 300 up to 600	2.4 (10.0)	± 2.0%	up to 50 mm = ± 0.5 mm up to 100 mm = ± 1.0 mm over 100 mm = ± 2.0 mm	± 0.10mm
- elastic - for fixed shaft centers - belts used as sets	200 - 600 600 - 3500	up to 300 up to 600	1.5 (10.0)	± 2.0%	up to 50 mm = ± 0.5 mm up to 100 mm = ± 1.0 mm over 100 mm = ± 2.0 mm	± 0.10mm
- accumulator conveyor - paper transport - very flexible	200 - 600 600 - 4400	up to 300 up to 600	0.8 (10.0)	± 0.5%	up to 50 mm = ± 0.5 mm up to 100 mm = ± 1.0 mm over 100 mm = ± 2.0 mm	± 0.10mm
- slightly elastic - for fixed shaft centers - belts used as sets	200 - 600 600 - 4400	up to 300 up to 600	0.9 (10.0)	± 0.5%	up to 50 mm = ± 0.5 mm up to 100 mm = ± 1.0 mm over 100 mm = ± 2.0 mm	± 0.10mm
- preferred lengths up to 2400mm - very good running characteristics - general applications	200 - 600 600 - 5000	up to 300 up to 600	1.0 (10.0)	± 0.5%	up to 50 mm = ± 0.5 mm up to 100 mm = ± 1.0 mm over 100 mm = ± 2.0 mm	± 0.10mm
- preferred lengths up to 2400mm - general applications - medium-duty drives	200 - 600 600 - 4800	up to 300 up to 600	1.5 (10.0)	± 0.5%	up to 50 mm = ± 0.5 mm up to 100 mm = ± 1.0 mm over 100 mm = ± 2.0 mm	± 0.10mm
- very low elongation	200 - 600 600 - 4600	up to 300 up to 600	1.0 (10.0)	± 1.0%	up to 50 mm = ± 0.5 mm up to 100 mm = ± 1.0 mm over 100 mm = ± 2.0 mm	± 0.10mm
- extremely low elongation - heavy-duty drives	200 - 600 600 - 4200	up to 300 up to 600	2.2 (10.0)	± 1.0%	up to 50 mm = ± 0.5 mm up to 100 mm = ± 1.0 mm over 100 mm = ± 2.0 mm	± 0.10mm
- speed-up conveyor - knife edge - low coefficient of friction on textile side	200 - 600 600 - 4200	up to 300 up to 600	0.9 (10.0)	± 0.5%	up to 50 mm = ± 0.5 mm up to 100 mm = ± 1.0 mm over 100 mm = ± 2.0 mm	± 0.10mm
- thin, highly flexible	200 - 600 600 - 4200	up to 300 up to 600	0.8 (10.0)	± 0.5%	up to 50 mm = ± 0.5 mm up to 100 mm = ± 1.0 mm over 100 mm = ± 2.0 mm	± 0.10mm

\*The standard durometer of PU coating is approx. 55 Shore A.

Changing the surface also means altering the coefficient of friction, thickness and thickness tolerances.

The following options are available:

- PU red hard (approx. 70 ± 7 Shore A)
- PU gray hard (approx. 70 ± 7 Shore A)
- PU yellow soft (approx. 30 ± 7 Shore A)

\*\*Additional dimensions & tolerances possible.

Length tolerances below ± 2.5 mm not possible.

## PU Surface Versions

ESBAND truly endless woven flat belts with a polyurethane coating are available with different surface finishes to meet the needs of a particular application. The following is a guideline to select a suitable finish combination.

### Coated and ground on one side

- Standard configuration
- Other side impregnated

### Coated and ground on both sides

- Increases the coefficient of friction
- Seals the carcass

### Special grinding

- Provides a very smooth finish
- Improves the belt thickness tolerance

### One side textile raw

- Only available for PU-Elastic, PU 12, PU 18 and PU 20/1
- Carcass material is exposed without penetration of the coating material from the other side
- Reduces the coefficient of friction

### Non-porous ply

- Seals the surface
- Stain resistant and easy to clean
- Increases the coefficient of friction

### Low friction coating

- Reduces the coefficient of friction on the coated side

### Silicone skim coat

- Can be applied to any polyurethane coated belts
- Increases the coefficient of friction
- Stain resistant and easy to clean

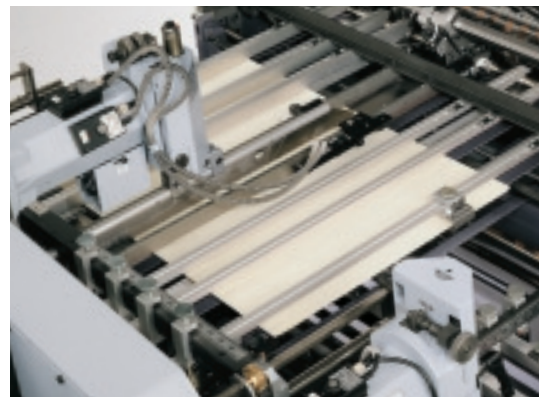
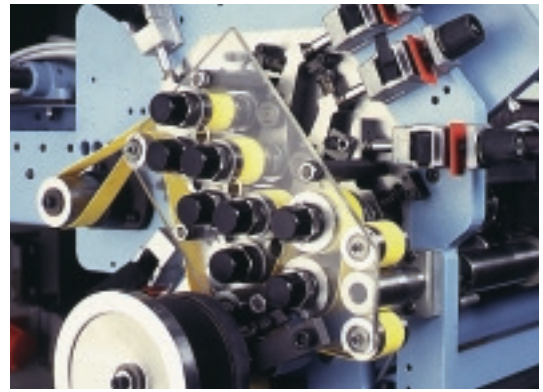

Surface Versions		Type										
one side	other side	PU 0/6	PU-Elastic	PU-Elastic 13	PU 4/6	PU 10	PU 11	PU 12	PU 17	PU 18	PU 20/1	PU 20
ground	uncoated		X	X	X	X	X	X	X	X		X
non-porous ply	uncoated		X	X	X	X	X	X	X	X		X
low-friction coating	uncoated		X	X	X	X						
special grinding/ low-friction coating	uncoated						X	X	X	X		X
ground	ground	X	X	X	X	X	X	X	X	X		X
ground	non-porous ply		X	X	X	X	X	X	X	X		X
ground	low-friction coating		X	X	X	X						
ground	textile raw		X	X				X		X	X	
ground	textile impregnated		X	X				X		X		
ground	special grinding / low-friction coating						X	X	X	X		X
non-porous ply	non-porous ply		X	X	X	X	X	X	X	X		X
non-porous ply	low-friction coating		X	X	X	X						
non-porous ply	textile raw		X	X				X		X	X	
non-porous ply	textile impregnated		X	X				X		X		
non-porous ply	special grinding / low-friction coating						X	X	X	X		X
low-friction coating	textile raw		X	X								
low-friction coating	textile impregnated		X	X								
low-friction coating	low-friction coating		X	X	X	X						
textile raw	special grinding / low-friction coating							X		X		
textile impregnated	special grinding / low-friction coating							X		X		
special grinding / low-friction coating	special grinding / low-friction coating							X		X		



NE Type	Surface Versions	Carcass Materials	Coating/ Hardness	Color	Break Strength per cm Endless Belt (Shaft Load)
NE Mini	- textured on one side, smooth on other side	Polyester	Neoprene 75±5 Shore A	black	550 N
NE 10	- textured on both sides - smooth on one side, textured on other side	Polyamide/ Polyester	Neoprene 75±5 Shore A	black	750 N
NE 10/133	- textured on one side, textile impregnated on other side - smooth on one side, textile impregnated on other side	Polyamide/ Polyester	Neoprene 75±5 Shore A	black	700 N
NE 17	- textured on one side, smooth on other side - ground on both sides	Kevlar®	Neoprene 75±5 Shore A	black	2400 N
NE 17/133	- textured on one side, textile impregnated on other side - smooth on one side, textile impregnated on other side	Kevlar®	Neoprene 75±5 Shore A	black	2400 N
NE 18	- textured on one side, smooth on other side - textured on both sides - ground on both sides	Kevlar®	Neoprene 75±5 Shore A	black	7950 N
NE 18 GA V 10535	- ground on both sides	Kevlar®	Neoprene 75±5 Shore A	black	11340 N
NE 20	- textured on both sides - textured on one side, smooth on other side	Polyester/ Cotton	Neoprene 75±5 Shore A	black	950 N
NE 20/133	- textured on one side, textile impregnated on other side	Polyester/ Cotton	Neoprene 75±5 Shore A	black	950 N
NE 20/1	- ground on one side, textile raw on other side - smooth on one side, textile raw on other side - textured on one side, textile raw on other side	Polyester/ Cotton	Neoprene 75±5 Shore A	black	950 N
NE 21	- textured on both sides - textured on one side, smooth on other side - ground on one or both sides	Polyester	Neoprene 75±5 Shore A	black	1700 N
NE 21/133	- textured on one side, textile impregnated on other side - smooth on one side, textile impregnated on other side	Polyester	Neoprene 75±5 Shore A	black	1700 N
NE 22	- textured on both sides - textured on one side, smooth on other side - ground on one or both sides	Polyester	Neoprene 75±5 Shore A	black	3400 N
NE 26	- textured on both sides - textured on one side, smooth on other side - ground on one or both sides	Polyester	Neoprene 75±5 Shore A	black	4150 N
NE 133 SB	- textured on one side, textile impregnated on other side	Polyester/ Cotton	Neoprene 75±5 Shore A	black	2100 N
NE 133/1	- textured on one side, textile raw on other side	Polyester/ Cotton	Neoprene 75±5 Shore A	black	2100 N
NE Elastic	- ground	without carcass	Neoprene 75±5 Shore A	black	on request

NE	Belt Elongation in % per cm Belt Width (Shaft Load)			Required Shaft Load for 1% Elongation per cm Belt Width	Minimum Pulley Diameter	Temperature Range		Recommended Pre-Tension	Anti-static
						Continuous	Intermittent		
	30 N 0.1 - 0.3%	100 N 0.5 - 0.7%	300 N 3.5 - 3.9%	170 ± 10 N	6 mm	-20 to +100°C	-25 to +140°C	0.4% - 0.8%	yes
	30 N 0.2 - 0.4%	100 N 1.1 - 1.5%	300 N 6.8 - 7.8%	80 ± 10 N	8 mm	-20 to +100°C	-25 to +140°C	0.4% - 0.8%	yes
	30 N 0.3 - 0.5%	100 N 1.3 - 1.6%	300 N 8.2 - 8.5%	70 ± 10 N	8 mm	-20 to +100°C	-25 to +140°C	0.4% - 0.8%	yes
	300 N 0.2 - 0.4%	600 N 0.5 - 0.7%	1000 N 0.9 - 1.1%	1040 ± 50 N	12 mm	-20 to +100°C	-25 to +140°C	0.1% - 0.3%	yes
	300 N 0.2 - 0.4%	600 N 0.5 - 0.7%	1000 N 0.9 - 1.1%	1040 ± 50 N	12 mm	-20 to +100°C	-25 to +140°C	0.1% - 0.3%	yes
	300 N 0.2 - 0.3%	600 N 0.4 - 0.5%	1000 N 0.6 - 0.7%	1700 ± 200 N	30 mm	-20 to +100°C	-25 to +140°C	0.1% - 0.3%	yes
	300 N 0.1 - 0.3%	600 N 0.3 - 0.5%	1000 N 0.5 - 0.7%	on request	50 mm	-20 to +100°C	-25 to +140°C	0.1% - 0.3%	yes
	100 N 0.4 - 0.6%	300 N 1.8 - 2.0%	600 N 5.5 - 5.9%	190 ± 10 N	10 mm	-20 to +100°C	-25 to +140°C	0.4% - 0.8%	yes
	100 N 0.4 - 0.6%	300 N 1.8 - 2.0%	600 N 5.5 - 5.9%	190 ± 10 N	10 mm	-20 to +100°C	-25 to +140°C	0.4% - 0.8%	yes
	100 N 0.4 - 0.6%	300 N 1.8 - 2.0%	600 N 5.5 - 5.9%	190 ± 10 N	8 mm	-20 to +100°C	-25 to +140°C	0.4% - 0.8%	yes
	100 N 0.3 - 0.4%	300 N 1.0 - 1.2%	600 N 4.0 - 4.5%	270 ± 10 N	15 mm	-20 to +100°C	-25 to +140°C	0.4% - 0.8%	yes
	100 N 0.3 - 0.4%	300 N 1.0 - 1.2%	600 N 4.0 - 4.5%	270 ± 10 N	15 mm	-20 to +100°C	-25 to +140°C	0.4% - 0.8%	yes
	100 N 0.2 - 0.3%	300 N 0.7 - 0.8%	600 N 1.6 - 1.7%	375 ± 15 N	20 mm	-20 to +100°C	-25 to +140°C	0.4% - 0.8%	yes
	300 N 0.8 - 0.9%	600 N 1.4 - 1.6%	1000 N 3.0 - 3.4%	385 ± 15 N	25 mm	-20 to +100°C	-25 to +140°C	0.2% - 0.5%	yes
	30 N 0.0 - 0.1%	300 N 0.5 - 0.7%	600 N 1.6 - 2.0%	300 ± 30 N	15 mm	-20 to +100°C	-25 to +140°C	0.4% - 0.8%	yes
	30 N 0.0 - 0.1%	300 N 0.5 - 0.7%	600 N 1.6 - 2.0%	300 ± 30 N	15 mm	-20 to +100°C	-25 to +140°C	0.4% - 0.8%	yes
	5 N 1.5 - 2.5%	15 N 8.0 - 12.0%	30 N 26.0 - 34.0%	on request	5 mm	-20 to +100°C	-25 to +140°C	5% - 6%	yes

NE	Properties	Standard Manufacturing Dimensions (mm)*			Standard Tolerances*		
		Length	Width	Thickness	Length	Width	Thickness
	- for miniature drives	120 - 330	up to 150	0.5	±0.5%	up to 50 mm = ± 0.5 mm up to 100 mm = ± 1.0 mm over 100 mm = ± 2.0 mm	±0.15mm
	- slightly elastic - for fixed shaft centers - belts used as sets	400 - 2000	5 - 420	0.8	±0.5%	up to 50 mm = ± 0.5 mm up to 100 mm = ± 1.0 mm over 100 mm = ± 2.0 mm	±0.15mm
	- running side textile impregnated and low coefficient of friction	400 - 2000	5 - 420	0.7	±0.5%	up to 50 mm = ± 0.5 mm up to 100 mm = ± 1.0 mm over 100 mm = ± 2.0 mm	±0.15mm
	- drive belt - very low elongation	400 - 4600	up to 420	0.9	±1.0%	up to 50 mm = ± 0.5 mm up to 100 mm = ± 1.0 mm over 100 mm = ± 2.0 mm	±0.15mm
	- drive belt with various coefficients of friction - very low elongation	250 - 400 400 - 4600	up to 350 up to 420	0.8	±1.0%	up to 50 mm = ± 0.5 mm up to 100 mm = ± 1.0 mm over 100 mm = ± 2.0 mm	±0.15mm
	- extremely low elongation - heavy-duty drives	400 - 4200	up to 420	2.0	±1.0%	up to 50 mm = ± 0.5 mm up to 100 mm = ± 1.0 mm over 100 mm = ± 2.0 mm	±0.15mm
	- extremely low elongation - heavy-duty drives	1800 - 9000	10 - 280	3.0	±1.0%	up to 50 mm = ± 0.5 mm up to 100 mm = ± 1.0 mm over 100 mm = ± 2.0 mm	±0.10mm
	- very flexible - good running characteristics	400 - 4200	up to 420	0.8	±0.5%	up to 50 mm = ± 0.5 mm up to 100 mm = ± 1.0 mm over 100 mm = ± 2.0 mm	±0.15mm
	- various coefficients of friction - very flexible	200 - 400 400 - 4200	up to 350 up to 400	0.7	±0.5%	up to 50 mm = ± 0.5 mm up to 100 mm = ± 1.0 mm over 100 mm = ± 2.0 mm	±0.15mm
	- speed-up conveyor - knife edge - low coefficient of friction on textile side	200 - 400 400 - 4200	up to 350 up to 420	0.8	±0.5%	up to 50 mm = ± 0.5 mm up to 100 mm = ± 1.0 mm over 100 mm = ± 2.0 mm	±0.15mm
	- high belt speeds - very good running characteristics - general applications	400 - 4800	up to 420	0.9	±0.5%	up to 50 mm = ± 0.5 mm up to 100 mm = ± 1.0 mm over 100 mm = ± 2.0 mm	±0.15mm
	- various coefficients of friction - very good running characteristics	250 - 400 400 - 4800	up to 350 up to 420	0.8	±0.5%	up to 50 mm = ± 0.5 mm up to 100 mm = ± 1.0 mm over 100 mm = ± 2.0 mm	±0.15mm
	- preferred lengths up to 2400mm - general applications - medium-duty drives	400 - 4800	up to 420	1.4	±0.5%	up to 50 mm = ± 0.5 mm up to 100 mm = ± 1.0 mm over 100 mm = ± 2.0 mm	±0.15mm
	- heavy-duty drives	400 - 4800	up to 420	2.0	±0.5%	up to 50 mm = ± 0.5 mm up to 100 mm = ± 1.0 mm over 100 mm = ± 2.0 mm	±0.15mm
	- spindle drives	400 - 4400	up to 420	1.3	±0.5%	up to 50 mm = ± 0.5 mm up to 100 mm = ± 1.0 mm over 100 mm = ± 2.0 mm	±0.15mm
	- speed-up conveyor - high load conveying	400 - 4400	up to 420	1.2	±0.5%	up to 50 mm = ± 0.5 mm up to 100 mm = ± 1.0 mm over 100 mm = ± 2.0 mm	±0.15mm
	- highly elastic - lagging material - belts used as sets - for fixed shaft centers	150 - 2000	up to 200	0.8 - 5.0	±1.0%	up to 50 mm = ± 0.5 mm up to 100 mm = ± 1.0 mm over 100 mm = ± 2.0 mm	±0.10mm

\*Additional dimensions & tolerances possible. Length tolerances below ± 2.5 mm not possible.



## Neoprene NE - Characteristics

Color: black

Antistatic

Temperature range -20°C to 100°C,  
intermittent -25°C to 140°C

Durometer approx. 75 Shore A

High coefficient of friction

Low abrasion

Good resistance to oils, greases, ozone

High flexibility

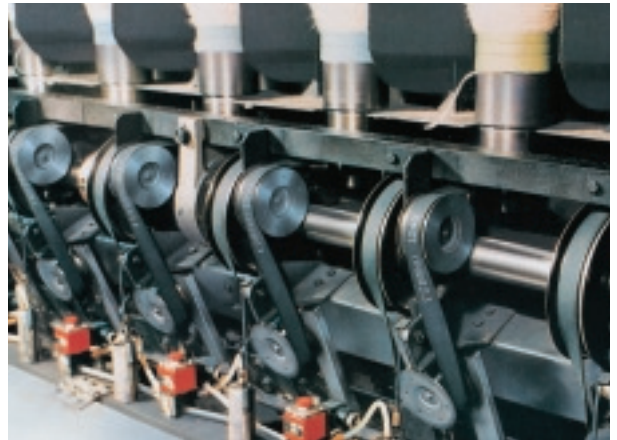

Type	Surface Versions	Carcass Materials	Coating/ Hardness	Colors	Break Strength per cm Endless Belt (Shaft Load)
<b>FX 05 white</b>	- ground on one side, structured on other side - smooth on one side, structured on other side	Polyamide/ Polyester	Polyurethane 80±5 Shore A	white	450 N
<b>FX 10</b> coated on both sides	- ground on one side, structured on other side	Polyamide/ Polyester	Polyurethane 80±5 Shore A	white	750 N
<b>FX 11</b>	- ground on one side, textile raw on other side	Polyester	Polyurethane 80±5 Shore A	white	1000 N
<b>FX 11</b> coated on both sides	- smooth on one side, structured on other side	Polyester	Polyurethane 80±5 Shore A	white	1000 N
<b>FX 17</b> coated on both sides	- smooth on one side, structured on other side	Kevlar®	Polyurethane 80±5 Shore A	white	2300 N
<b>FX 20</b>	- ground on one side, textile raw on other side	Polyester/ Cotton	Polyurethane 80±5 Shore A	white	1360 N
<b>FX 20</b> coated on both sides	- ground on both sides	Polyester/ Cotton	Polyurethane 80±5 Shore A	white	1300 N
<b>SI 1</b>	- see table on page 13 for all possible surface versions	Polyester	Silicone 30±5 Shore A	white, gray	1450 N
<b>SI 3</b>	- see table on page 13 for all possible surface versions	Polyester/ Cotton	Silicone 30±5 Shore A	white, gray	800 N
<b>HN 1</b>	- see table on page 13 for all possible surface versions	Nomex	Silicone 30±5 Shore A	white, gray	820 N
<b>HG 1</b>	- see table on page 13 for all possible surface versions	Fiberglass	Silicone 30±5 Shore A	white, gray	1080 N
<b>HK 17</b>	- see table on page 13 for all possible surface versions	Kevlar®	Silicone 30±5 Shore A	white, gray	1700 N
<b>HK 18</b>	- see table on page 13 for all possible surface versions	Kevlar®	Silicone 30±5 Shore A	white, gray	5800 N
<b>PC</b>	- one side textured, textile impregnated on other side	Polyester/ Cotton	PVC 50±10 Shore A	red	2750 N
<b>PC 1</b>	- one side textured, textile raw on other side	Polyester/ Cotton	PVC 50±10 Shore A	red	2750 N
<b>PC 1 + SI carrying side</b>	- one side textured, silicone ground on other side	Polyester/ Cotton	PVC 50±10 Shore A	red/ white	2750 N
<b>PC 1 + PU carrying side</b>	- one side textured, polyurethane ground on other side	Polyester/ Cotton	PVC 50±10 Shore A	red/ yellow	2750 N

	Belt Elongation in % per cm Belt Width (Shaft Load)			Required Shaft Load for 1% Elongation per cm Belt Width	Minimum Pulley Diameter	Temperature Range		Antistatic	Properties
						Continuous	Intermittent		
	100 N 1.1 - 1.3%	300 N 4.6 - 5.2%	400 N 6.3 - 7.0%	90 ± 10 N	6 mm	-10 to +80°C	-10 to +80°C	possible	- very thin and flexible
	30 N 0.3 - 0.5%	100 N 2.2 - 2.6%	300 N 8.8 - 9.3%	55 ± 10 N	15 mm	-10 to +80°C	-10 to +80°C	possible	- slightly elastic
	100 N 0.3 - 0.5%	300 N 1.3 - 1.7%	600 N 5.0 - 5.8%	230 ± 20 N	10 mm	-10 to +80°C	-10 to +80°C	possible	- very good running characteristics
	100 N 0.3 - 0.5%	300 N 1.3 - 1.7%	600 N 5.0 - 5.8%	230 ± 20 N	20 mm	-10 to +80°C	-10 to +80°C	possible	- very good running characteristics
	300 N 0.3 - 0.4%	600 N 0.6 - 0.7%	1000 N 0.9 - 1.0%	1040 ± 50 N	20 mm	-10 to +80°C	-10 to +80°C	possible	- low elongation
	30 N 0.1 - 0.2%	100 N 0.5 - 0.7%	300 N 2.1 - 2.6%	165 ± 15 N	15 mm	-10 to +80°C	-10 to +80°C	possible	- speed-up conveyor
	100 N 0.6 - 0.7%	300 N 1.8 - 2.0%	600 N 4.6 - 5.1%	170 ± 15 N	15 mm	-10 to +80°C	-10 to +80°C	possible	- good running characteristics
	100 N 0.3 - 0.5%	300 N 2.0 - 2.2%	600 N 6.6 - 7.0%	190 ± 20 N	12 mm	-20 to +150°C	-20 to +180°C	possible	- dirt-resistant - resistant to adhesives - weighing belt
	30 N 0.0 - 0.2%	300 N 1.4 - 1.6%	600 N 4.3 - 4.7%	135 ± 15 N	10 mm	-20 to +120°C	-20 to +160°C	possible	- dirt-resistant - highly flexible - knife edge
	30 N 0.0 - 0.1%	300 N 1.8 - 2.2%	600 N 7.5 - 8.5%	170 ± 20 N	20 mm	-50 to +180°C	-60 to +250°C	possible	- temperature-resistant - dirt-resistant - resistant to adhesives
	30 N 0.0 - 0.1%	300 N 0.5 - 0.7%	600 N 0.8 - 1.2%	600 ± 50 N	20 mm	-60 to +200°C	-60 to +250°C	possible	- temperature-resistant - resistant to adhesives - resistant to chemicals - dirt-resistant
	300 N 0.9 - 1.2%	600 N 1.4 - 1.7%	1000 N 1.9 - 2.2%	290 ± 50 N	20 mm	-50 to +200°C	-50 to +250°C	possible	- temperature-resistant - low elongation
	300 N 0.3 - 0.5%	600 N 0.5 - 0.8%	1000 N 0.9 - 1.0%	990 ± 100 N	20 mm	-50 to +200°C	-50 to +250°C	possible	- temperature-resistant - low elongation
	100 N 0.0 - 0.1%	300 N 0.6 - 0.8%	600 N 1.5 - 1.8%	380 ± 30 N	15 mm	-10 to +60°C	-10 to +80°C	no	- very good resistance to acids and bases - high coefficient of friction
	100 N 0.0 - 0.1%	300 N 0.6 - 0.8%	600 N 1.5 - 1.8%	380 ± 30 N	12 mm	-10 to +60°C	-10 to +80°C	no	- speed-up conveyor - different values of coefficient of friction
	100 N 0.0 - 0.1%	300 N 0.6 - 0.8%	600 N 1.5 - 1.8%	380 ± 30 N	25 mm	-10 to +60°C	-10 to +80°C	no	- conveyor belt with various coefficients of friction
	100 N 0.0 - 0.1%	300 N 0.6 - 0.8%	600 N 1.5 - 1.8%	380 ± 30 N	25 mm	-10 to +60°C	-10 to +80°C	no	- conveyor belt with various coefficients of friction



Standard Manufacturing Dimensions (mm)*			Standard Tolerances*			
Length	Width	Thickness (max.)	Length	Width	Thickness	
480 - 4800	5 - 900	0.5	±0.5%	up to 50 mm = ± 0.5 mm over 100 mm = ± 2.0 mm	up to 100 mm = ± 1.0 mm	±0.15 mm
480 - 4000	5 - 900	1.0	±0.5%	up to 50 mm = ± 0.5 mm over 100 mm = ± 2.0 mm	up to 100 mm = ± 1.0 mm	±0.15 mm
480 - 4000	5 - 900	1.4	±0.5%	up to 50 mm = ± 0.5 mm over 100 mm = ± 2.0 mm	up to 100 mm = ± 1.0 mm	±0.10 mm
480 - 4000	5 - 900	1.2	±0.5%	up to 50 mm = ± 0.5 mm over 100 mm = ± 2.0 mm	up to 100 mm = ± 1.0 mm	±0.15 mm
480 - 4000	5 - 900	1.3	±1.0%	up to 50 mm = ± 0.5 mm over 100 mm = ± 2.0 mm	up to 100 mm = ± 1.0 mm	±0.15 mm
480 - 4000	5 - 900	0.7 - 0.9	±0.5%	up to 50 mm = ± 0.5 mm over 100 mm = ± 2.0 mm	up to 100 mm = ± 1.0 mm	±0.10 mm
480 - 4000	5 - 900	1.0	±0.5%	up to 50 mm = ± 0.5 mm over 100 mm = ± 2.0 mm	up to 100 mm = ± 1.0 mm	±0.10 mm
<b>PC</b>						
200 - 600 600 - 4800	up to 300 up to 600	1.0 (10.0)	±0.5%	up to 50 mm = ± 0.5 mm over 100 mm = ± 2.0 mm	up to 100 mm = ± 1.0 mm	±0.10 mm
200 - 600 600 - 4200	up to 300 up to 600	1.0 (10.0)	±0.5%	up to 50 mm = ± 0.5 mm over 100 mm = ± 2.0 mm	up to 100 mm = ± 1.0 mm	±0.10 mm
200 - 600 600 - 4200	up to 300 up to 600	1.5 (10.0)	±0.5%	up to 50 mm = ± 0.5 mm over 100 mm = ± 2.0 mm	up to 100 mm = ± 1.0 mm	±0.10 mm
200 - 600 600 - 4200	up to 300 up to 600	1.5 (10.0)	±1.0%	up to 50 mm = ± 0.5 mm over 100 mm = ± 2.0 mm	up to 100 mm = ± 1.0 mm	±0.10 mm
200 - 600 600 - 4600	up to 300 up to 600	1.3 (10.0)	±1.0%	up to 50 mm = ± 0.5 mm over 100 mm = ± 2.0 mm	up to 100 mm = ± 1.0 mm	±0.10 mm
200 - 600 600 - 4200	up to 300 up to 600	2.0 (10.0)	±1.0%	up to 50 mm = ± 0.5 mm over 100 mm = ± 2.0 mm	up to 100 mm = ± 1.0 mm	±0.10 mm
<b>PC</b>						
500 - 4200	up to 400	1.1	±0.5%	up to 50 mm = ± 0.5 mm over 100 mm = ± 2.0 mm	up to 100 mm = ± 1.0 mm	±0.15 mm
500 - 4200	up to 400	1.0	±0.5%	up to 50 mm = ± 0.5 mm over 100 mm = ± 2.0 mm	up to 100 mm = ± 1.0 mm	±0.15 mm
500 - 4200	up to 400	2.0	±0.5%	up to 50 mm = ± 0.5 mm over 100 mm = ± 2.0 mm	up to 100 mm = ± 1.0 mm	±0.15 mm
500 - 4200	up to 400	2.0	±0.5%	up to 50 mm = ± 0.5 mm over 100 mm = ± 2.0 mm	up to 100 mm = ± 1.0 mm	±0.15 mm

\*Additional dimensions & tolerances possible. Length tolerances below ± 2.5 mm not possible.

## Compact Polyurethane FX

## Silicone SI

## PVC PC

### Compact Polyurethane FX

Color: white

Durometer approx. 80 Shore A

FDA

Temperature range -10°C to 80°C,

intermittent -10°C to 80°C

Surface versions: smooth, ground  
or structured

Only available in certain thicknesses

### Silicone SI

Colors: white, gray

Durometer approx. 30-35 Shore A

FDA

Temperature range -60°C to 200°C,

intermittent -60°C to 250°C

High coefficient of friction

Resistant to dirt and chemicals

### PVC PC

Color: red

Temperature range -10°C to 60°C,

intermittent -10°C to 80°C

Resistant to chemicals and microbes



Surface versions		Type					
one side	other side	SI 1	SI 3	HN 1	HG 1	HK 17	HK 18
ground	uncoated	X	X	X	X	X	X
silicone skim coat	uncoated	X	X	X	X	X	X
ground	ground	X	X	X	X	X	X
ground	silicone skim coat	X	X	X	X	X	X
silicone skim coat	silicone skim coat	X	X	X	X	X	X

# Design Considerations

ESBAND truly endless woven flat belts offer the opportunity to create limitless belt drive designs. Below is a helpful guideline regarding pulley designs, belt layout, placement of idlers and special belt drive designs.

## Flat belt guiding by crowned pulleys

Textile flat belts run with a high degree of directional stability. To ensure optimum belt tracking at least one of the pulleys should be crowned. The remaining pulleys may then be flat.

If crowned or large pulley widths are not available due to manufacturing limitations, then one of the other illustrated crown forms may be substituted.

**Important note:** To maximize the service life of the belt, pulleys which rotate in the same direction should be designed with the same crown configuration.

Recommended materials are steel, cast iron or aluminum with surface roughness of  $R_a$  3.2 $\mu$ m or  $R_a$  1.6 $\mu$ m.

## Crowned Pulley Design Dependent on Belt Width b

b (mm)	b <sub>s</sub> (mm)	h (mm)	r <sub>s</sub> (mm)
10	13	0.3	71
13	16	0.3	107
16	20	0.3	167
20	25	0.3	261
25	32	0.3	427
32	40	0.4	500
40	50	0.4	782
50	63	0.4	1241
63	80	0.4	2000
80	100	0.5	2500
100	125	0.5	3907
125	160	0.6	5334
160	200	0.7	7143
200	250	0.8	9766

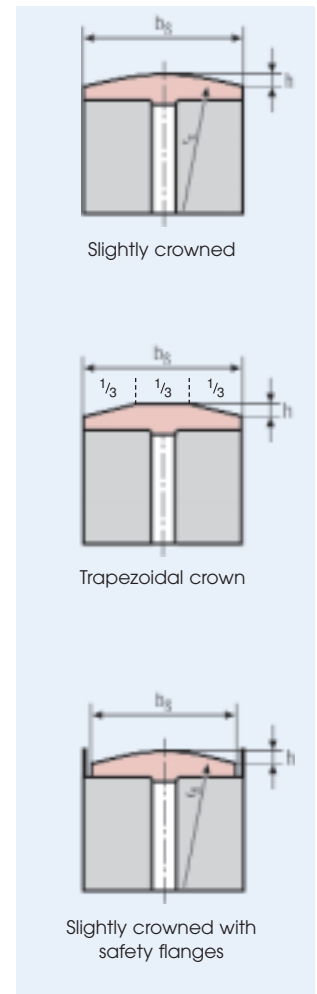
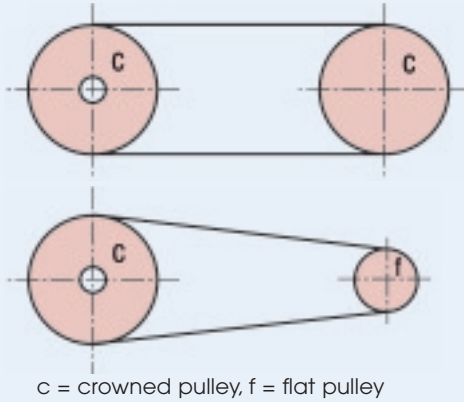



Fig. 1



## Design of the belt drive with crowned / flat pulleys

With gearing ratios exceeding 3:1 and horizontal shaft positions, the small pulley may be flat. In the case of drives with vertical shaft positions it is recommended to have both pulleys crowned.

(see Fig. 1)

For Multi-Shaft belt drives, the pulleys with the biggest diameters and rotating in the same direction, must be crowned.

(see Fig. 2)

Fig. 2

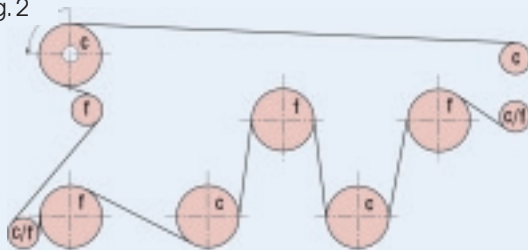

## Arrangement of tensioning rollers

When using tensioning rollers the following must be observed:

- The diameter of the tensioning roller should be selected as large as possible
- The tensioning roller should always be in the slack side of the drive
- The tensioning roller should always be flat
- The necessary pre-tension can be applied by using tensioning roller, eccentric tensioner, spring tension or the inherent elasticity of the belt

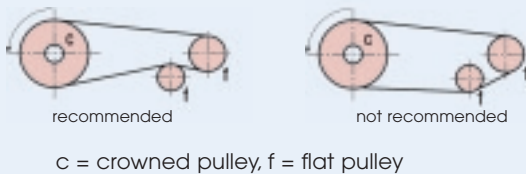

## Properties of the conveyor belts in the designs shown on the left hand side:

- Low coefficient of friction on running side
- Belt thickness as thin as possible (especially knife edge and checkweigher belts)
- If necessary, increase coefficient of friction on the pulley (rubber coating on pulley)
- Chemical-resistant
- Antistatic (carcass)
- Belts with self-tracking guides

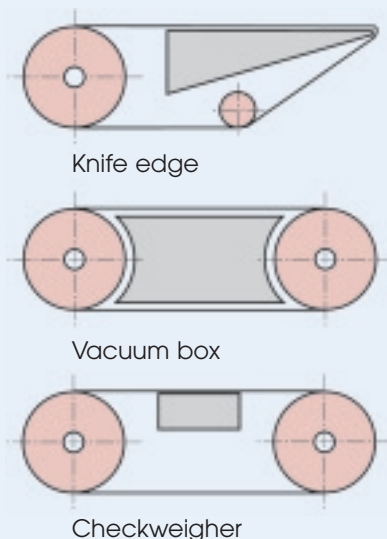

# Belt Sizing

## 1. Calculation example for standard drives

The calculation example is based on the following:

- Power  $P = 7.5 \text{ kW}$
- Pulley dia.  $d_1 = 140 \text{ mm}$
- Pulley Speed  $n_1 = 2900 \text{ rpm}$
- Pulley dia.  $d_2 = 52 \text{ mm}$
- Number of pulleys  $z = 2$
- Shaft center distance  $e = 165 \text{ mm}$
- Belt type selected: NE 22
- Coefficient of friction  $= 0.5 \mu$
- Duty factor  $C_B = 0.9$

**1.1 Belt length  $L =$**   

$$2 \cdot e + \frac{\pi}{2} (d_2 + d_1) + \frac{(d_2 - d_1)^2}{4 \cdot e} = 643 \text{ mm}$$

**1.2 Belt speed  $v =$**   

$$\frac{d_1 \cdot n_1}{19100} = 21.26 \text{ m/s}$$

**1.3 Bending frequency  $f_B =$**   

$$1000 \cdot z \cdot \frac{v}{L} = 66 \text{ 1/s}$$

**1.4 Arc of contact  $\beta =$**   

$$180 - \frac{60 \cdot |d_1 - d_2|}{e} = 148^\circ$$

Please check graph 4 "Determining the bending frequency" for min. allowable pulley diameter

**1.5 Specific rated power  $P_N =$**   
 According to graph 3:  
 $2.3 \text{ kW per cm of belt width}$

**1.6 Belt width  $b =$**   

$$\frac{10 \cdot P}{C_B \cdot P_N} = 36.2 \text{ mm} \Rightarrow \text{select } 40 \text{ mm}$$

**1.7 Strand force ratio  $m =$**   

$$2.71828^{\frac{\beta \cdot \pi \cdot \mu}{180}} = 3.64$$
  
 (Euler's number)

**1.8 Minimum pre-tension  $F_V =$**   

$$\frac{m+1}{m-1} \cdot \frac{500 \cdot P}{v} + \frac{1.21 \cdot b \cdot v^2}{1000} = 331.9 \text{ N}$$

**1.9 Static shaft load  $F_W =$**   

$$2 \cdot F_V \cdot \sin \frac{\beta}{2} = 638.1 \text{ N}$$

**1.10 Suggested ordering text:**  
 ESBAND NE 22; 643 x 40 mm ,  
 or closest preferred size = 650 x 40 mm

## 2. Selecting the Duty factor $C_B$

- 1.0**  
 Steady operation, small mass to be accelerated
- 0.9**  
 Almost steady operation, medium mass to be accelerated
- 0.75**  
 Non-steady operation, medium mass to be accelerated
- 0.65**  
 Non-steady operation, large mass to be accelerated, heavy shock loads

## 3. Relationship between transmittable power and belt speed

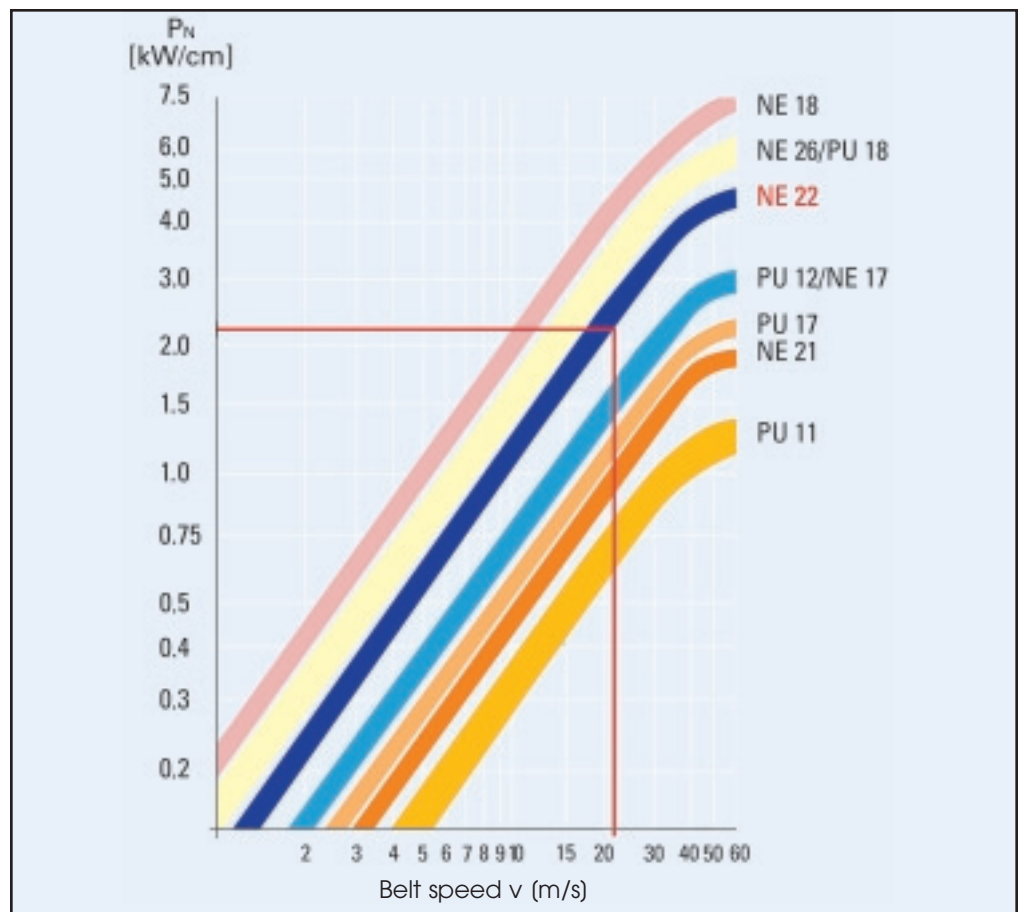

## 4. Determining the bending frequency $f_B$

Guide values for maximum bending frequency and minimum pulley diameter for ESBAND truly endless woven drive belts of standard thickness.

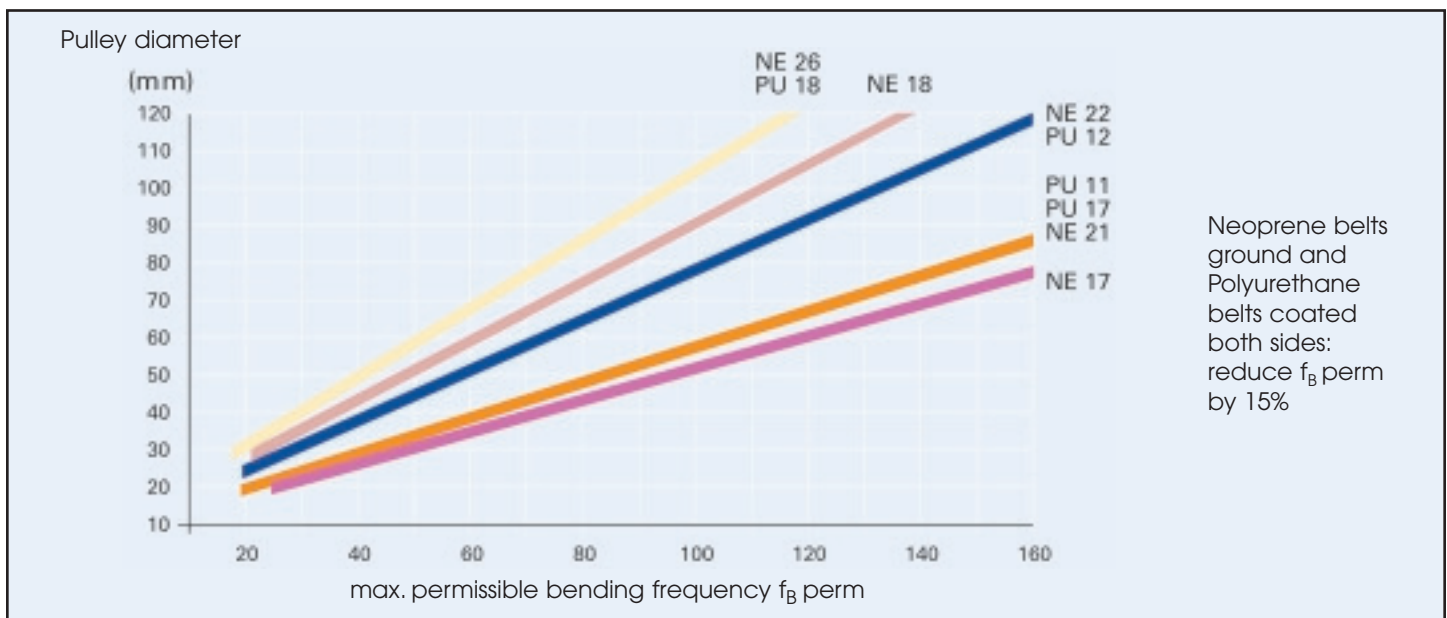

## 5. Equations for special drive designs

### Crossed Belt Drive

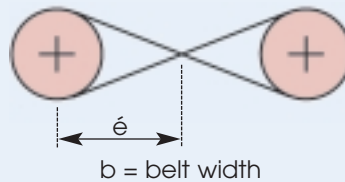

**Determining the minimum shaft center distance:**

$$\acute{e} \geq 20 \cdot b$$

**Calculating the belt length:**

$$L = 4 \cdot \acute{e} + \frac{\pi}{2} (d_1 + d_2) + \frac{(d_1 + d_2)^2}{8 \cdot \acute{e}}$$

### Half-Crossed Belt Drive

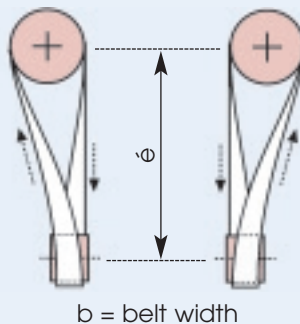

**Determining the minimum shaft center distance:**

$$\acute{e} \geq 20 \cdot b$$

**Calculating the belt length:**

$$L = 2 \cdot \acute{e} + \frac{\pi}{2} (d_1 + d_2) + \frac{d_1^2 + d_2^2}{4 \cdot \acute{e}}$$

### Perpendicular Belt Drive

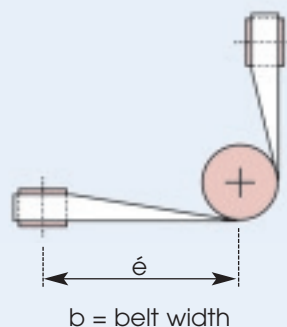

**Determining the minimum shaft center distance:**

$$\acute{e} \geq 20 \cdot b$$

**Calculating the belt length:**

$$L = 4 \cdot \acute{e} + \frac{\pi}{2} (d_1 + d_2 + d_3) + \frac{d_1^2 + d_2^2}{8 \cdot \acute{e}}$$

# Belt Examples

1



PU gray  
Vacuum Flat Belt

2



PU yellow  
Vacuum Timing Belt

3



PU red  
Vacuum Timing Belt

4



PU yellow  
Profiled Flat Belt

5

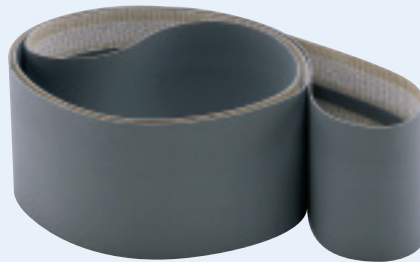

SI gray  
Flat Belt with Self-Tracking Guide

6

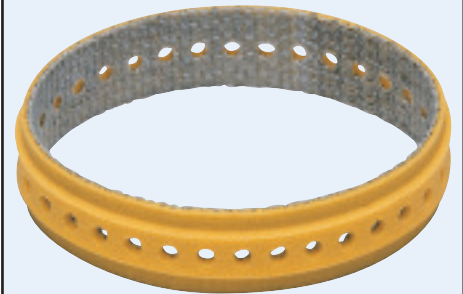

PU yellow  
Machined Vacuum Flat Belt

7

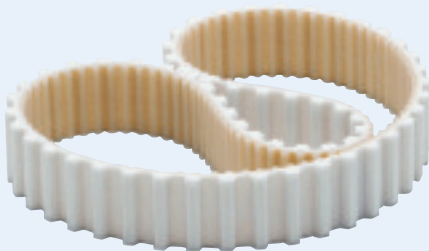

PU white  
Custom Machined Timing Belt

8



Web  
Vacuum Flat Belt

9

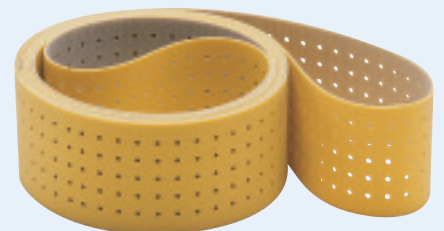

PU yellow  
Vacuum Flat Belt



# Belt Examples

10

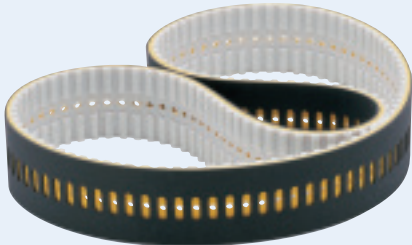

PU gray/yellow  
Vacuum Timing Belt

11



PU red  
Machined Vacuum Flat Belt

12



SI gray  
Vacuum Flat Belt

13



SI gray  
Vacuum Flat Belt

14



PU yellow  
Multi V-Belt

15



SI gray  
Flat Belt with Self-Tracking Guide

16



PU gray/yellow  
Custom Machined Timing Belt

17



PU gray  
Vacuum Flat Belt

18

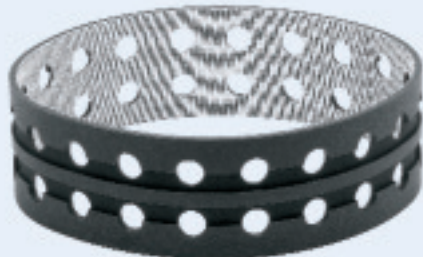

PU gray  
Machined Vacuum Flat Belt

**FOR IMMEDIATE RESPONSE PLEASE SEND DESIGN INFORMATION**

**Basic design:**

Type of machine: \_\_\_\_\_

Give number of Shafts in design: \_\_\_\_\_

Power P: \_\_\_\_\_ kW  
or  
Torque  $M_1$ : \_\_\_\_\_ Nm

Dia. of drive pulley  $d_1$ : \_\_\_\_\_ mm

Max. permissible pulley width  $bs_1$ : \_\_\_\_\_ mm

Drive pulley speed  $n_1$ : \_\_\_\_\_ rpm

Shaft center distance e: \_\_\_\_\_ mm  
adjustable by: \_\_\_\_\_ mm

Dia. of driven pulley  $d_2$ : \_\_\_\_\_ mm

Max. permissible pulley width  $bs_2$ : \_\_\_\_\_ mm

New design  
or  
 Existing drive

Number of belts: \_\_\_\_\_

Belt dimensions (L x W x T): \_\_\_\_\_

**Pre-tension achieved by:**

Proportional shortening of the belt length with fixed shaft centers

Take up

Tensioning pulley

Other: \_\_\_\_\_

**External influencing factors:**

Oil                       Dust

Water

Chemicals \_\_\_\_\_

Heat \_\_\_\_\_ °C / \_\_\_\_\_ °F

**Does the belt operate outdoors?**

Yes                       No

Name \_\_\_\_\_

Company \_\_\_\_\_

Street \_\_\_\_\_













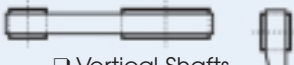

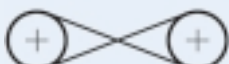
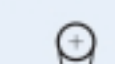

City/State/Zip-Code \_\_\_\_\_

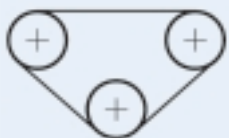
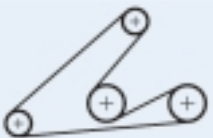
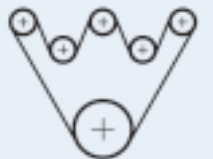
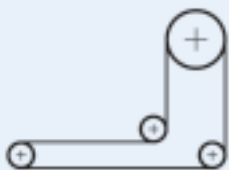
Phone \_\_\_\_\_

Fax \_\_\_\_\_

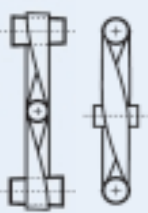
e-mail \_\_\_\_\_

**Belt Drive Design - please check:**

		<input type="checkbox"/> Horizontal						
<input type="checkbox"/> Open Drive	<input type="checkbox"/> Inclined	<input type="checkbox"/> Vertical	<input type="checkbox"/> Perpendicular Belt Drive	Half-Crossed Belt Drive <input type="checkbox"/> left <input type="checkbox"/> right	<input type="checkbox"/> Tensioning roller outside	<input type="checkbox"/> Tensioning roller inside		
		<input type="checkbox"/> Crossed Belt Drive						
		<input type="checkbox"/> Half-Crossed Belt Drive with guide roller						
<input type="checkbox"/> Multi-Shaft Drive	<input type="checkbox"/> Triangular Drive	<input type="checkbox"/> Reverse Drive	<input type="checkbox"/> Serpentine Drive	<input type="checkbox"/> Deflecting Drive	<input type="checkbox"/> Jockey Drive			
<input type="checkbox"/> Conical Belt Drive with guide rollers	<input type="checkbox"/> Conical Crossed Belt Drive with guide fork	<input type="checkbox"/> Twin Drive	<input type="checkbox"/> Stepped Pulley	<input type="checkbox"/> Oscillating Shaft	<input type="checkbox"/> Fixed and loose Pulley			

**FOR IMMEDIATE RESPONSE PLEASE SEND DESIGN INFORMATION**

**Basic design:**

Type of machine:

\_\_\_\_\_

Belt length: \_\_\_\_\_ mm

Belt width: \_\_\_\_\_ mm

Belt thickness: \_\_\_\_\_ mm

Dia. of driving pulley  $d_1$ : \_\_\_\_\_ mm

Dia. of driven pulley  $d_2$ : \_\_\_\_\_ mm

Shaft center distance  $e$ : \_\_\_\_\_ mm

Motor power  $P$ : \_\_\_\_\_ kW

Drive pulley speed  $n_1$ : \_\_\_\_\_ rpm

Number of belts: \_\_\_\_\_

Goods to be transported and/or weighed: \_\_\_\_\_

Belt tracking

FDA approved

Temperature range \_\_\_\_\_ °C / \_\_\_\_\_ °F

Chemical-resistant to \_\_\_\_\_

Antistatic

Extreme climate

Weighing belt

Speed-up conveyor

Tensioning device  Yes  No

Coefficient of friction on running side:

low  high

Coefficient of friction on carrying side:

low  high

\_\_\_\_\_ Name

\_\_\_\_\_ Company

\_\_\_\_\_ Street

\_\_\_\_\_ City/State/Zip-Code

\_\_\_\_\_ Phone

\_\_\_\_\_ Fax

\_\_\_\_\_ e-mail

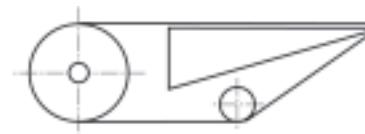

Knife edge



Checkweigher

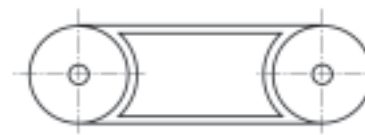

Vacuum belt  
(perforations as shown in sketch)

**Sketch:**

# BRECOflex Product Catalogs

ISO 9001  
CERTIFIED  
COMPANY

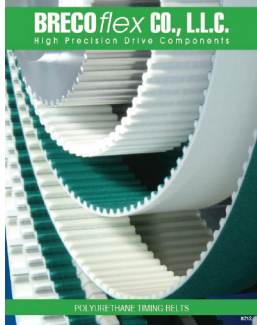

## Polyurethane Timing Belts

Industry leading polyurethane timing belts in Metric and English pitches. Widest range of available options.

Catalog #B212

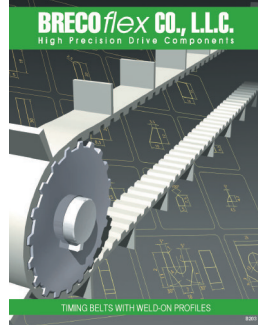

## Polyurethane Timing Belts with Weld-on Profiles

Dividing, Stepping, Positioning.

Catalog #B203

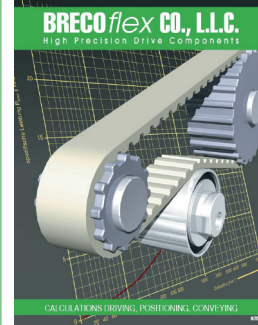

## Calculations Driving, Positioning, Conveying

Power, Torque, and Peripheral Force calculations.

Catalog #B204



## Accessory Items for Polyurethane Timing Belts

Pulleys, Tensioners, Clamps, Tensioning Clamps.

Catalog #B205



## Tension Meter

Improve Performance, lifetime, positioning accuracy, bearing load, and noise level.

Catalog #B207

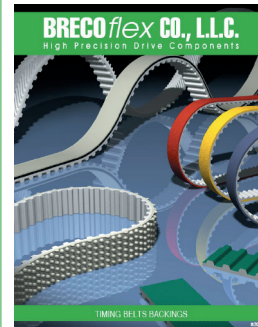

## Timing Belts Backings

Polyurethane Timing Belts in Metric and English pitches with a wide range of cover materials.

Catalog #B208

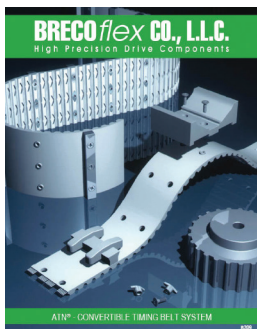

## ATN - Convertible Timing Belt System

ATN technology allows the reconfiguration of profiled timing belts at the customer site.

Catalog #B209



## ESBAND Truly Endless Woven Flat Belts

Wide variety of Polyurethane, Neoprene and Silicone state-of-the-art flat belts.

Catalog #B210

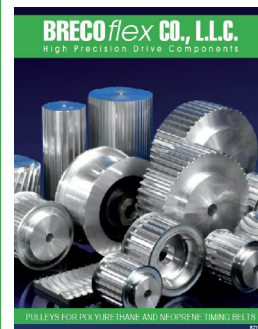

## Pulleys for Polyurethane and Neoprene Timing Belts

Finished pulleys and stock pulley program.

Catalog #B216



## ARC-POWER Technology

ARC-POWER Technology Best Performing Timing Belts Available.

Catalog #B217

# BRECOflex CO., L.L.C.

High Precision Drive Components

222 Industrial Way West • Eatontown • NJ 07724

Tel: 732-460-9500 • Fax: 732-542-6725

[www.brecoflex.com](http://www.brecoflex.com)

email: [info@brecoflex.com](mailto:info@brecoflex.com)

Copyright 2003 BRECOflex CO., L.L.C. • BRECO®, BRECOFLEX® & ATN® are registered trademarks of BRECO Antriebstechnik GmbH • ARC-POWER® is a registered trademark of BRECOflex CO., L.L.C. • Kevlar® is a registered trademark of DuPont Patents Pending • ESBAND® is a registered trademark of Max Schlatterer GmbH & Co. KG Patents Pending. Specifications are subject to change without prior notice.

All recommendations for the use of the products described herein and all other data or information set forth in this publication, whether concerning such products or otherwise, are furnished without any guarantee, warranty representations or inducement of any kind whether expressed or implied, including but not limited to warranties of merchantability and fitness for a particular purpose. BRECOflex CO., L.L.C. expressly disclaims liability under any theory, including without limitation, contract negligence, misrepresentation or breach of any obligation relating to the recommendation, data or information set forth herein. Readers and customers are encouraged to conduct their own test before using any product. Read its label and all related instructions. BRECOflex CO., L.L.C. reserves the right to make changes in the technical and dimensional specifications of its products without prior notice. Responsibility for expenses incurred as a result of product changes or discontinuance of a product lies solely with the purchaser.