

Datasheet - ZQ 700-02

Pull-wire emergency stop switches / ZQ 700



Preferred typ



- Thermoplastic enclosure
- one-side operation / wire up to 10 m long
- Release push button
- Position indicator
- Large wiring compartment
- Twisting of towing eye not possible
- wire pull and breakage detection
- One tension force for cable lengths up to 10 m
- 1 Cable entry M 20 x 1.5

(Minor differences between the printed image and the original product may exist!)

Ordering details

Product type description	ZQ 700-02
Article number	101192478
EAN code	4030661352671
eCl@ss	27-37-12-90

Approval

Approval

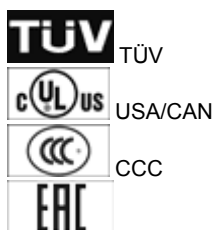

Classification

Standards	EN ISO 13849-1
B _{10d} Opener (NC)	100.000
Mission time	20 Years
notice	$MTTF_d = \frac{B_{10d}}{0,1 \times n_{op}}$ $n_{op} = \frac{d_{op} \times h_{op} \times 3600 \text{ s/h}}{t_{cycle}}$

Global Properties

Product name	ZQ 700
Standards	IEC/EN 60947-5-1, IEC/EN 60947-5-5, EN ISO 13850
Compliance with the Directives (Y/N) 	Yes
Materials	
- Material of the housings	Plastic, thermoplastic
- Material of the cover	Plastic, thermoplastic
- Material of the contacts	Silver
Weight	216 g
Emergency-Stop button (Y/N)	No

Mechanical data

Design of electrical connection	Screw connection
Cable section	
- Min. Cable section	0,75 mm ²
- Max. Cable section	2.5 mm ²
Mechanical life	> 1.000.000 operations
notice	All indications about the cable section are including the conductor ferrules.
Length of wire	max. 10 m

Ambient conditions

Ambient temperature	
- Min. environmental temperature	-25 °C
- Max. environmental temperature	+70 °C
Protection class	IP67 to IEC/EN 60529

Electrical data

Design of control element	Opener (NC)
Switching principle	Snap switch element
Number of auxiliary contacts	0 piece
Number of safety contacts	2 piece
Rated impulse withstand voltage U_{imp}	6 kV
Rated insulation voltage U_i	500 V
Thermal test current I_{the}	10 A
Utilisation category	AC-15: 230 V / 4 A, DC-13: 24 V / 4 A
Max. fuse rating	6 A gG D-fuse

Dimensions

Dimensions	
- Width	40.5 mm
- Height	160 mm
- Depth	50.9 mm

notice

At 2 bis 5 m distance intermediate wire supports are required, see accessories

Recommended cable lengths for pull-wire Emergency-Stop switches in relation to the range of ambient temperature.

Code: mrl_zq700_cs

Operating instructions and Declaration of conformity (it) 467 kB, 02.03.2015

Code: mrl_zq700_it

Operating instructions and Declaration of conformity (fr) 473 kB, 16.02.2017

Code: mrl_zq700_fr

Operating instructions and Declaration of conformity (de) 451 kB, 07.02.2017

Code: mrl_zq700_de

Operating instructions and Declaration of conformity (en) 465 kB, 07.02.2017

Code: mrl_zq700_en

Operating instructions and Declaration of conformity (pt) 470 kB, 07.02.2017

Code: mrl_zq700_pt

Operating instructions and Declaration of conformity (es) 934 kB, 09.12.2009

Code: mrl_zq700_es

Operating instructions and Declaration of conformity (es) 471 kB, 09.02.2017

Code: mrl_zq700_es

Operating instructions and Declaration of conformity (pl) 503 kB, 08.03.2017

Code: mrl_zq700_pl

TÜV certification (en, de) 727 kB, 24.02.2017

Code: z_tq7p02

TÜV certification (de, en) 727 kB, 24.02.2017

Code: z_tq7p01

TÜV certification (de, en) 727 kB, 24.02.2017

Code: z_tq7p03

CCC certification (en) 819 kB, 15.08.2016

Code: q_zq7p02

CCC certification (cn) 814 kB, 15.08.2016

Code: q_zq7p03

EAC certification (ru) 844 kB, 05.10.2015

Code: q_6037p17_ru

Images

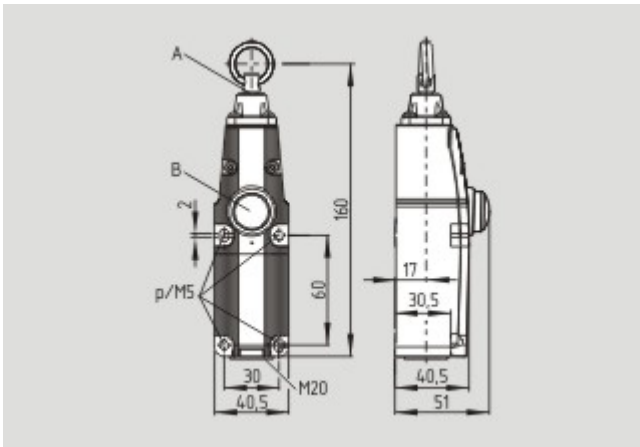

Dimensional drawing (basic component)

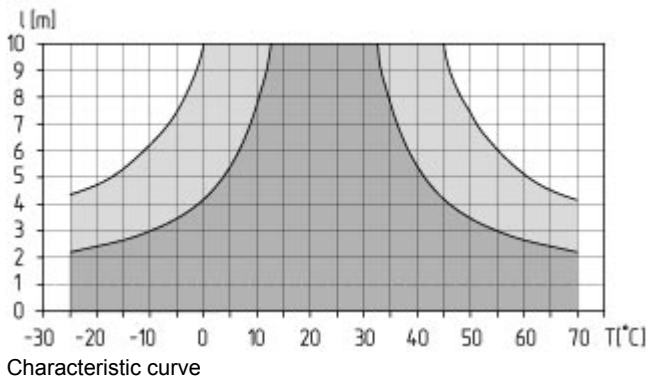

Characteristic curve

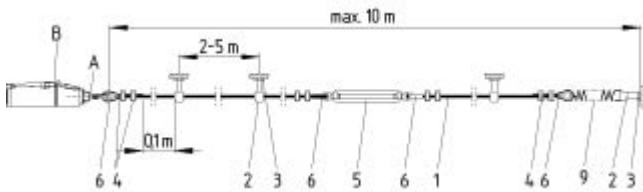

Application

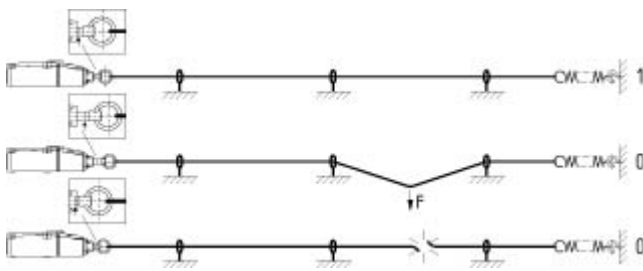

Application

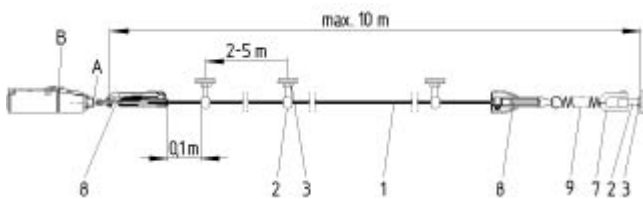

Application

System components

Accessories

101192471 - Eyebolt BM 8 x 70 NIRO



101084928 - Eyebolt BM 10 x 40



101203477 - Wire clamp 3 mm NIRO



101203478 - Wire clamp 5 mm NIRO



101190917 - Duplex wire clamp 3 mm NIRO

- for Wire rope Ø 3 mm



101196043 - Egg-shaped wire clamp GR 3

- for Wire rope Ø 3 mm



101203472 - WIRE THIMBLE 3 mm NIRO

- for Wire rope Ø 3 mm
- to DIN 6899



101203476 - WIRE THIMBLE 5 mm NIRO

- for Wire rope Ø 5 mm
- to DIN 6899





101192433 - PULLEY

- for Wire rope \varnothing 3 mm
- To guide the wire rope where the path is not a straight line



101087930 - TENSIONING JACK M6

- For exact adjustment of the tension of the wire rope
- to DIN 1480



103005863 - TENSION SPRING ACC-700-RZ173I

- To maintain the reaction force



101186490 - SHACKLE NIRO

- Shackle for fixing the wire rope to the eyebolt



101078670 - WIRE ROPE 5 mm

- With red PVC sheath
- \varnothing 5 mm total
- Steel core \varnothing 3 mm
- Quantity: Meter



103003628 - WIRE UNIT COMPLETE 5 m

- Ready-to-fit
- With red PVC sheath



103003629 - WIRE UNIT COMPLETE 10 m

- Ready-to-fit
- With red PVC sheath

101186704 - rope tensioner S 900

- Smooth adjustment
- Only one tool
- Antiskid
- Time-saving



- Ergonomic
 - No risk of injury
-



103003510 - MP ZQ/TQ700-71

- Mounting plate set for ZQ 700 / TQ 700
-



103006013 - ACC-CGLD-M20-P

- cable gland M20
 - Plastic
-

K.A. Schmersal GmbH & Co. KG, Möddinghofe 30, D-42279 Wuppertal

The data and values have been checked thoroughly. Technical modifications and errors excepted.

Generiert am 18.05.2017 - 09:21:27h Kasbase 3.2.6.F.64I