

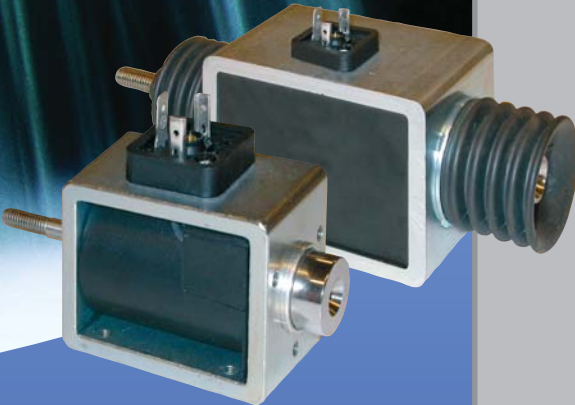

BINDER NEUE HAHN MAGNET *thoma*
MAGNETTECHNIK

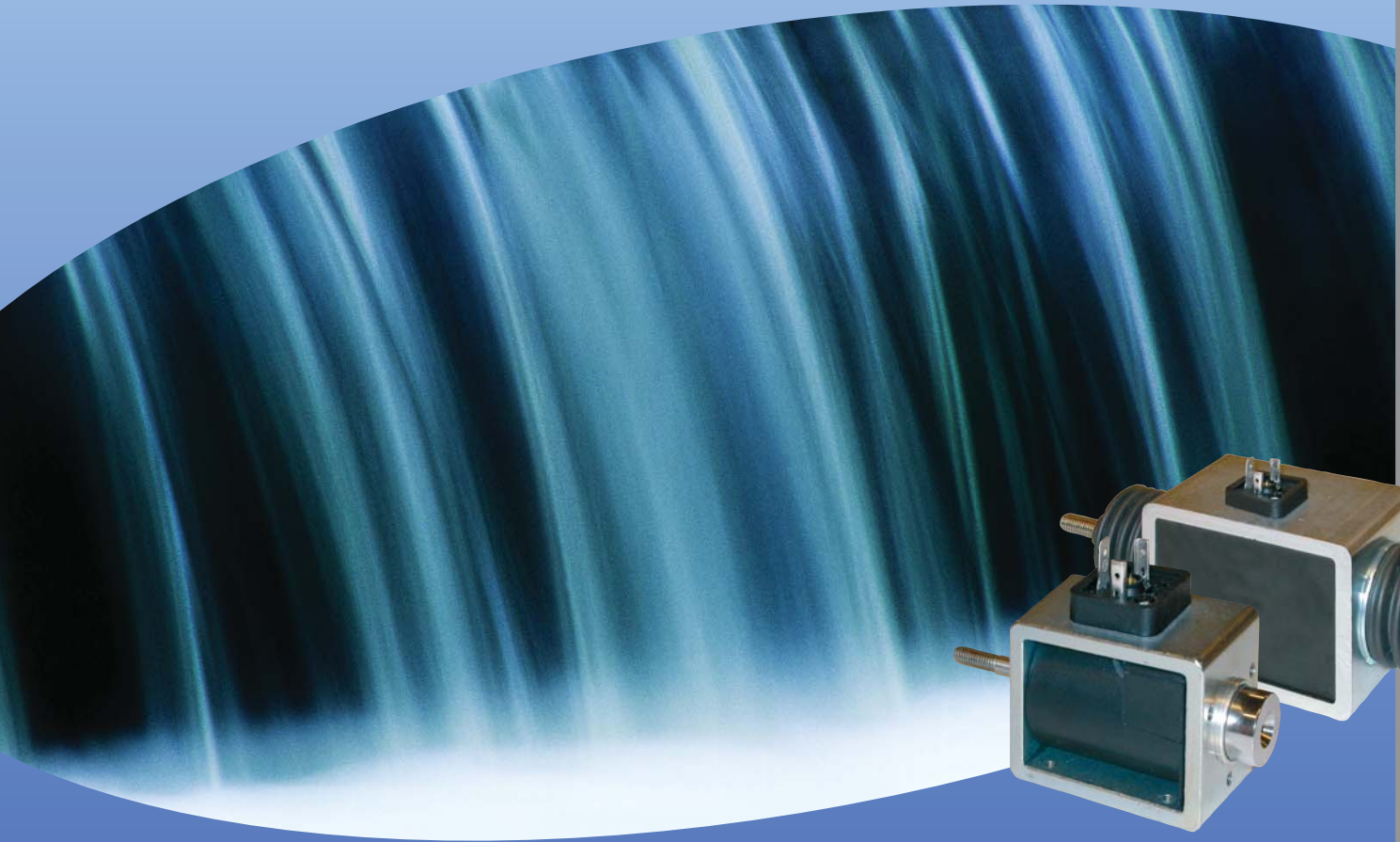

FAST RELIABLE UNIVERSAL

- DC SINGLE DIRECTION LINEAR SOLENOIDS
- MONOSTABLE DC SINGLE DIRECTION LINEAR SOLENOIDS



POWER OF PARTNERSHIP AND MAGNETISM

CLASSIC LINE

The KENDRION ELECTROMAGNETIC COMPONENTS Group (KEC Group) sees itself as a centre of excellence in the field of electromagnetism.

KENDRION MAGNETTECHNIK GmbH develops and manufactures a wide range of electromagnetic products in the most diverse variations and designs for countless technical applications. The company grew out of the traditional operations of Binder, Thoma and Neue Hahn and is now Europe's leading manufacturer of electromagnetic components.

Project work is our focal point. We at KENDRION MAGNETTECHNIK take this to mean the joint development of devices together with our customers, taking into account special operating conditions, special requirements and high economic efficiency. Our objective is to provide the market with the devices it needs. With optimised costs-benefits ratios to secure the competitiveness of our customers.

Our many years of experience in the development and manufacture of electromagnetic devices plus the skills and commitment of our employees enable us to recognise the needs of the market. And we turn those needs into high-quality products in cooperation with our customers.

We at KENDRION MAGNETTECHNIK achieve customer-focused solutions in all corporate divisions. Those solutions bring maximum benefits for customers and hence considerably strengthen their position in their markets.

- **Customer-centred market management,**
- **innovative product developments,**
- **lean, flexible logistics,**
- **high quality standards,**
- **affordable prices,**
- **and the power of magnetism guarantee the success of KENDRION MAGNETTECHNIK.**



KENDRION MAGNETTECHNIK - YOUR ONE-STOP SOLUTION



Type LCL024031



Type LCL032040



Type LCL040050

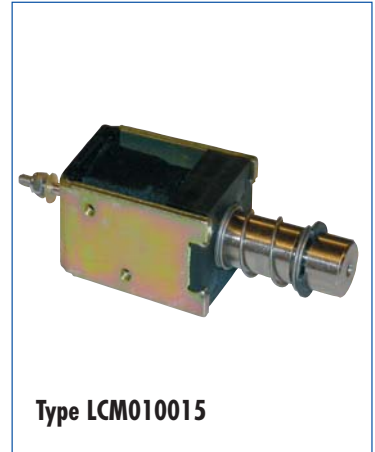

Type LCM010015

DC single direction linear solenoids
Monostable DC single direction linear solenoids

DC single direction linear solenoids are the universal, inexpensive answer for precision engineering and industrial applications as well as for locking/latching requirements.

They can be installed in any position. Push or pull actuation is possible. However, the force transfer should be in the axial direction only; lateral loads increase the wear on the bearings.

For details of life expectancy and switching frequency, please consult the manufacturer.

The application of an electromagnetic force brings about a linear movement from the initial position to the end position; the return movement is accomplished with external forces or, as an option, by incorporating a return spring. The devices are not fitted with a plunger stop as standard.

Standard rated voltage

24V DC

Standard duty cycle

100%

The duty cycle is based on a maximum total cycle time of 5 minutes.

Other voltages, duty cycles not given in the tables and stroke adjustments are available for a surcharge.

The switching times given in the tables are for guidance only. They are valid for the rated voltage, operating temperature and loaded with 70% of the magnetic force of the device.

Ambient temperature: 35°C

Insulation class: B

The products are manufactured and tested to DIN VDE 0580 (July 2000).

Class of protection: to IEC 60529

For further information on the use of electromagnetic devices please refer to the publication "The Technical Background".

CE symbol solenoids/electronics

electromagnets, electromagnetic devices

The electromagnetic products from Kendrion Magnettechnik are components for incorporation and operation in electrical equipment and devices.

They therefore do not fall within the remit of the Low Voltage Directive 73/23/EEC.

However, the components comply with various standards for incorporation and operation in devices covered by the Low Voltage Directive, in particular DIN VDE 0580 (July 2000). The corresponding data is given on the data sheets for the individual components.

The products are components in the meaning of the Machinery Directive 98/37/EC. According to this directive, such products incorporated in a machine may not be operated until said machine's conformity with the EC directive has been established. A manufacturer's declaration, which is not automatically supplied with the product, can be obtained on request.

The user must ensure conformity with the EMC Directive 89/336/EEC by using suitable switching devices or controls. When using the recommended electronic switching devices and controls from Kendrion Magnettechnik, conformity with the EMC Directive is stated on the respective data sheets.

Notes:

- to DIN VDE 0580 (July 2000) ICS29.020.53.020.01 (valid as manufacturer's Declaration of Conformity)
- directives 98/37/EC and 73/23/EEC
- CCC certificate for China not required

We reserve the right to make changes to the product design.

DC single direction linear solenoids, force ranges/sizes (duty cycles 5 to 100%)

Type	Stroke (mm)	Force (N) in relation to duty cycle																
		0	0.2	0.3	0.4	0.5	1	1.5	2	2.5	3	3.5	4	4.5	5	7.5	10	15
LCL012014	3		0.2															11.0
LCL015018	3						0.7											5.2
LCL018022	4								1.7									8.5
LCL018024	6									2.0								11.5
LCL024031	6												3.7					
LCL030035	15										3.0							
LCL032040	8																	10
LCL040050	20																	8.0
LCL048060	25																	12.5
LCL050060	12																	
LCL060070	25																	
LCL070080	30																	

Notes:

diagram

															Page	Size		
5	17.5	20	25	30	40	50	70	100	125	150	175	200	250	400	500		mm	
																	6-7	12 x 14 x 30
																	6-7	15 x 18 x 25
																	6-7	18 x 22 x 31.5
																	6-7	18 x 24 x 40.5
			25.0														6-7	24 x 31 x 40
				30.0													10-11, 12-13	30 x 35 x 45
					37.0												8-9	32 x 40 x 60
						68.0											10-11, 12-13	40 x 50 x 65
										150.0							10-11, 12-13	48 x 60 x 75
				24.0							170.0						8-9	50 x 60 x 80
			21.0											245.0			10-11, 12-13	60 x 70 x 90
					35.0										400.0		10-11, 12-13	70 x 80 x 105

Type LCL...



Options

- Return spring possible with some types

Design

Lead wires, class of protection IP 00 to IEC 60529. Insulation class B to DIN VDE 0580 (July 2000). The magnetic forces specified are based on operating temperature and 90% of the rated voltage. Owing to completely normal scatter effects, deviations in the magnetic force of $\pm 10\%$ may occur.

Standard rated voltage = 24 VDC

Standard duty cycle = 100%

Other voltages, duty cycles not given in the tables and stroke adjustments are available for a surcharge. Different supply voltages may lead to magnetic force values higher or lower than the specified values owing to the changing copper factor.

LCL012014 to LCL024031

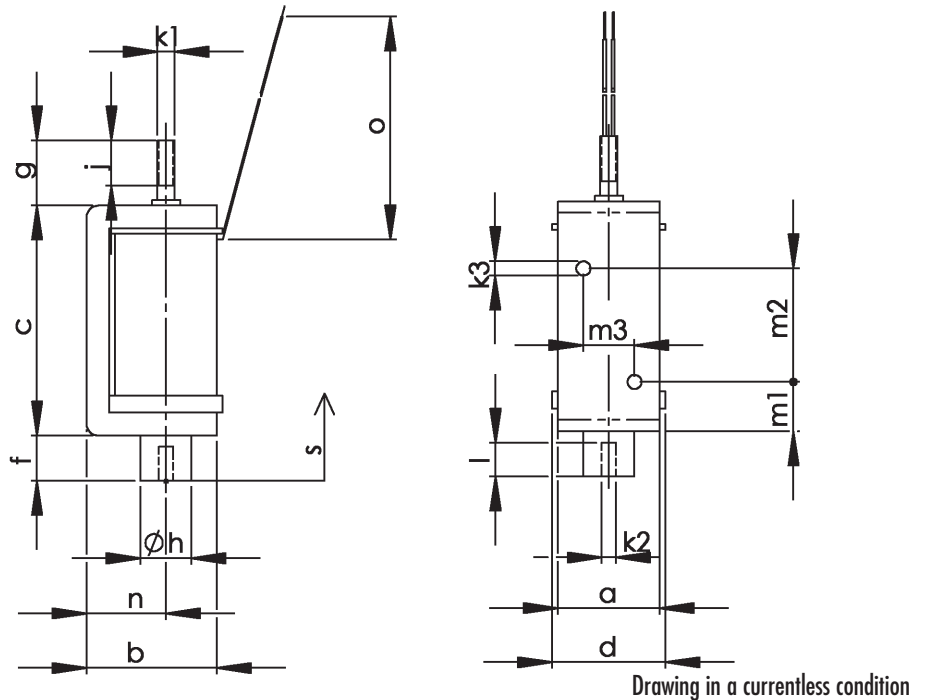

DC single direction linear solenoids

The DC single direction linear solenoids of the LCL012014 to LCL024031 series are open frame solenoids with a plunger and a punched C-frame. The plunger guide is in the form of a brass sleeve. The solenoid has threaded fixing holes on the side. Parts at risk of corrosion are electrogalvanised to EN 12329. The plunger has an electroless nickel plate finish to ISO 4527.

For a small surcharge, this series can be supplied with a specially coated plunger, which substantially increases the life expectancy. The high-quality special coating with a highly wear-resistant sliding surface and particularly low friction coefficient enables many additional switching operations.

New applications, which hitherto had been the exclusive province of heavy-duty DC linear solenoids for reasons of life expectancy, are now open to these devices.

We reserve the right to make changes without prior notice.

DC single direction linear solenoids (dimensions in mm)

Designation	a	b	c	d	e	f	g	h	i	k ₁	k ₂	k ₃	m ₁	m ₂	m ₂	l	n	o
LCL012014	12	14	30	13	3	5	12.5	6	8	M2	M3	M3	6	18	6	6	8	130
LCL015018	15	18	25	16	3	8	10	7	7	M2	M3	M3	8	10	9	6	10.2	130
LCL018022	18	22	31.5	20	4	6	10	8	8.5	M3	M3	M3	5.5	20	8	6	12	130
LCL018024	18	24	40.5	20	6	8	9.5	9	8.5	M3	M3	M3	8.7	20	9	6	13.5	130
LCL024031	24	31	40	26	6	8	10	12	10	M3	M3	M4	7.5	25	14	6	16.5	130

DC single direction linear solenoids

Types LCL012014 to LCL024031, ascending characteristic

Magnetic force and performance data:

duty cycle (%); stroke (mm); rated power (W); magnetic force (N); times (ms); linear work (Ncm); weight (kg)

Type	100% duty cycle				40% duty cycle				Plunger weight	Solenoid weight
	Rated power	Linear work	Response time	Release time	Rated power	Linear work	Response time	Release time		
LCL012014	4	0.11	23	20	7.6	0.21	21	19	0.006	0.02
LCL015018	3.8	0.2	34	31	7.5	0.4	31	30	0.005	0.04
LCL018022	6.7	0.77	45	40	13.2	1.16	41	39	0.01	0.06
LCL018024	7.6	1.48	42	45	16	2.38	40	43	0.014	0.08
LCL024031	8.7	2.7	48	38	18	4.5	47	36	0.024	0.15

Type	25% duty cycle				5% duty cycle				Plunger weight	Solenoid weight
	Rated power	Linear work	Response time	Release time	Rated power	Linear work	Response time	Release time		
LCL012014	11	0.23	20	16	35	0.66	17	15	0.006	0.02
LCL015018	10,5	0.5	31	30	34.5	1.25	29	30	0.005	0.04
LCL018022	19	1.52	40	37	63	3.02	38	36	0.01	0.06
LCL018024	23.5	2.88	37	43	87	5.75	35	41	0.014	0.08
LCL024031	25.5	5.7	47	34	89	11.8	45	32	0.024	0.15

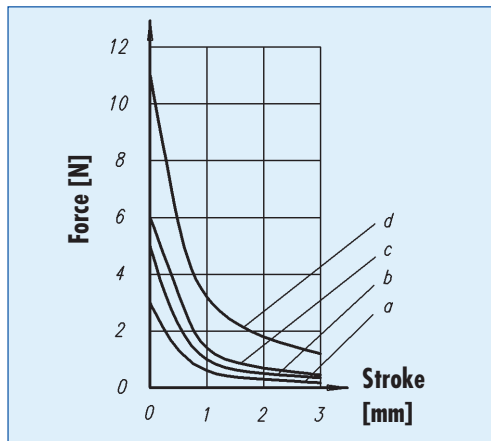

LCL012014 (GCM 3015)

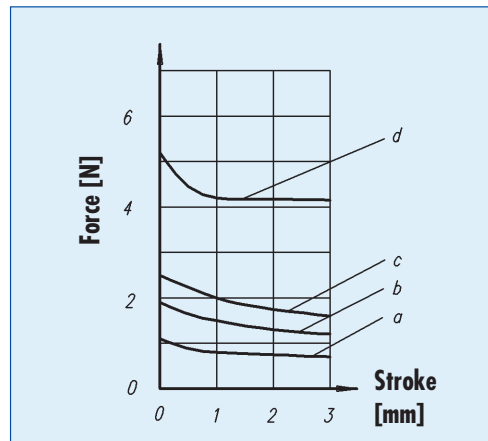

LCL015018 (GCM 2518)

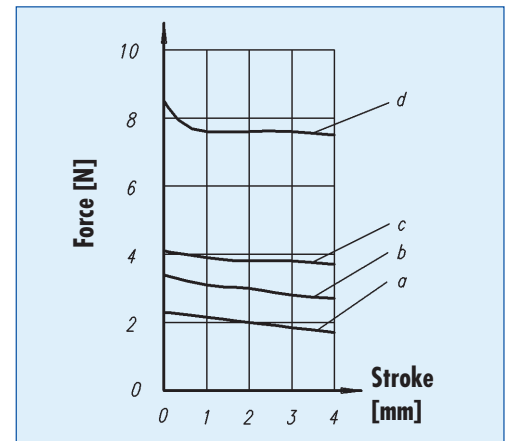

LCL018022 (GCM 3220)

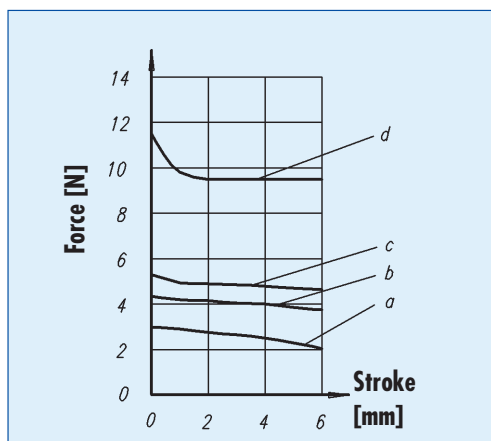

LCL018024 (GCM 4025)

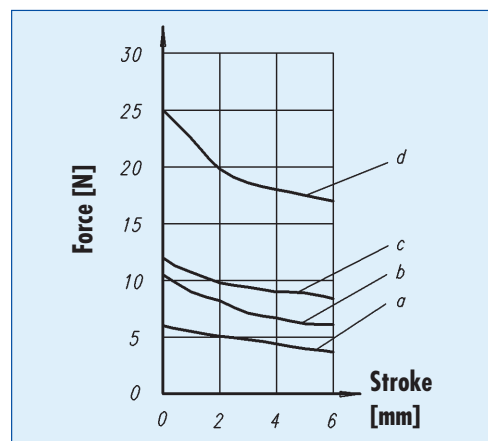

LCL024031 (GCM 4030)

Legend

- a: 100% duty cycle
- b: 40% duty cycle
- c: 25% duty cycle
- d: 5% duty cycle
- (...): former designation

Example of order

DC single direction linear solenoid
LCL018024
24 VDC
100% duty cycle

Type LCL...



Options

- Plug-in connection to DIN EN 175301-803 (DIN 43650)
- Bellows
- Return spring
- Fork joint
- Plug-in connector with bridge rectifier
- Switching device with overvoltage (rated power of solenoid max. 48 W)
- See "Accessories" data sheet

Design

Device: IP 00
 Connection: lead wires, class of protection IP 00, or device connector to DIN EN 175301-803 (DIN 43650), class of protection IP 65 to IEC 60529.
 Insulation class B to DIN VDE 0580 (July 2000).
 The magnetic forces specified are based on operating temperature and 90% of the rated voltage.
 Standard rated voltage = 24 VDC
 Standard duty cycle = 100%
 Different supply voltages may lead to magnetic force values higher or lower than the specified values owing to the changing copper factor.

LCL032040 to LCL050060

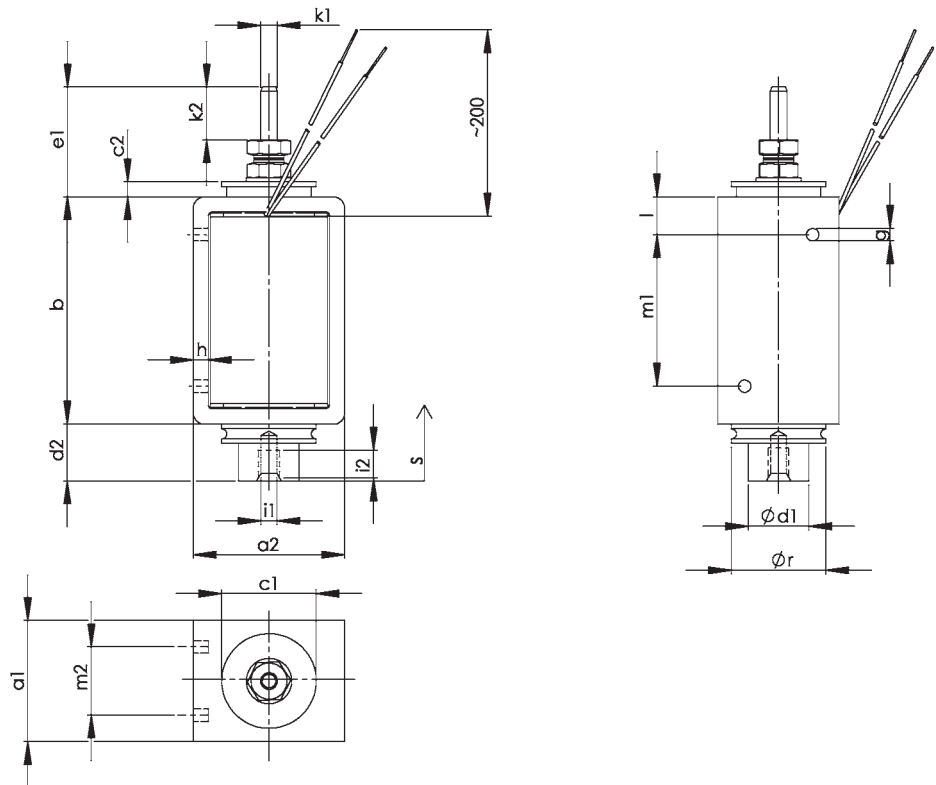

Drawing in a currentless condition

DC single direction linear solenoids

The DC single direction linear solenoids of the LCL032040 and LCL050060 series meet high standards in terms of performance and life expectancy. Compact dimensions and low power consumption, fast switching times and smooth operation characterise these series.

New applications, which hitherto had been the exclusive province of heavy-duty DC linear solenoids for reasons of life expectancy, are now open to these devices.

The C-frame is fabricated from profiled steel strip. The plunger is guided in highly wear-resistant maintenance-free precision bearings on both sides. That means consistent solenoid performance throughout the long service life of these components. The solenoid has threaded fixing holes on one side; additional threaded holes at the ends are possible on request. The coil is wrapped in tape as standard but can also be supplied encapsulated for a surcharge.

Parts at risk of corrosion are electrogalvanised to EN 12329. The plunger has a phosphate conversion coating to EN 12476. The use of a plug-in connector to DIN EN 175301-803 (DIN 43650) with integral rectifier enables these solenoids to be operated directly in AC systems. The plug-in connector is not included in the scope of supply and must be ordered separately (see "Accessories" data sheet).

We reserve the right to make changes without prior notice.

Dimensions of LCL032040 and LCL050060 (mm)

Designation	s	a1	a2	b	c1	c2	d1	d2	e1	g	h	i1	i2	k1	k2	l	m1	m2	r
LCL032040	8	32	40	60	25	4	16	15	29	M4	4	M5	8	M5	14	10	40	18	25
LCL050060	12	50	60	80	38	4.5	24	22	36	M5	4	M6	10	M6	20	15	50	32	38

DC single direction linear solenoids

Types LCL032040 and LCL050060

Magnetic force and performance data:

duty cycle (%); stroke (mm); rated power (W); magnetic force (N); times (ms); linear work (Ncm); weight (kg)

Type	100% duty cycle				40% duty cycle				Plunger weight	Solenoid weight
	Rated power	Linear work	Response time	Release time	Rated power	Linear work	Response time	Release time		
LCL032040	15	8.4	120	85	31	14.4	110	75	0.055	0.25
LCL050060	28.5	38	230	100	60	69	160	100	0.27	1.25

Type	25% duty cycle				5% duty cycle				Plunger weight	Solenoid weight
	Rated power	Linear work	Response time	Release time	Rated power	Linear work	Response time	Release time		
LCL032040	46	18	100	70	170	30.4	80	60	0.055	0.25
LCL050060	87	82	140	95	320	139	100	90	0.27	1.25

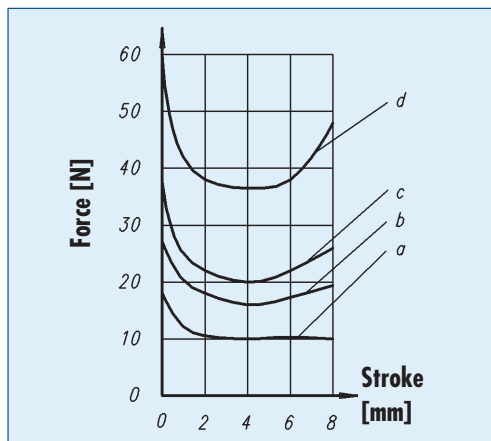

LCL032040 (DBM 6040)

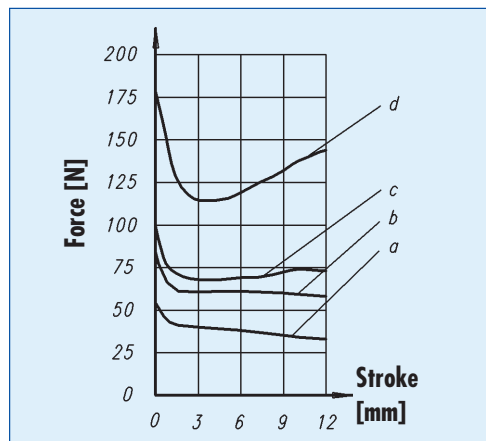

LCL050060 (DBM 8060)

Legend
a: 100% duty cycle
b: 40% duty cycle
c: 25% duty cycle
d: 5% duty cycle
(...): former designation

Example of order
DC single direction linear solenoid
LCL032040
24 VDC
5% duty cycle

Type LCL...

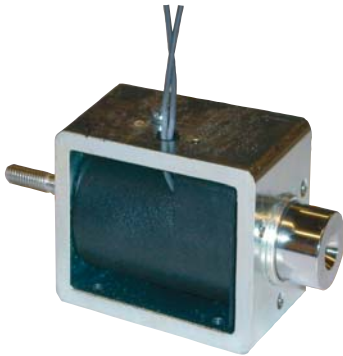

Options

- Plug-in connection to DIN EN 175301-803 (DIN 43650)
- Return spring • Fork joint
- Plug-in connector with bridge rectifier
- Switching device with overvoltage (rated power of solenoid max. 48 W)
- See "Accessories" data sheet

Design

Device: IP 40
 Connection: lead wires, class of protection IP 00, or device connector to DIN EN 175301-803 (DIN 43650), class of protection IP 65 to IEC 60529.
 Insulation class B to DIN VDE 0580 (July 2000).
 The magnetic forces specified are based on operating temperature and 90% of the rated voltage.
 Standard rated voltage = 24 VDC
 Standard duty cycle = 100%
 Different supply voltages may lead to magnetic force values higher or lower than the specified values owing to the changing copper factor.

LCL030035 to LCL070080

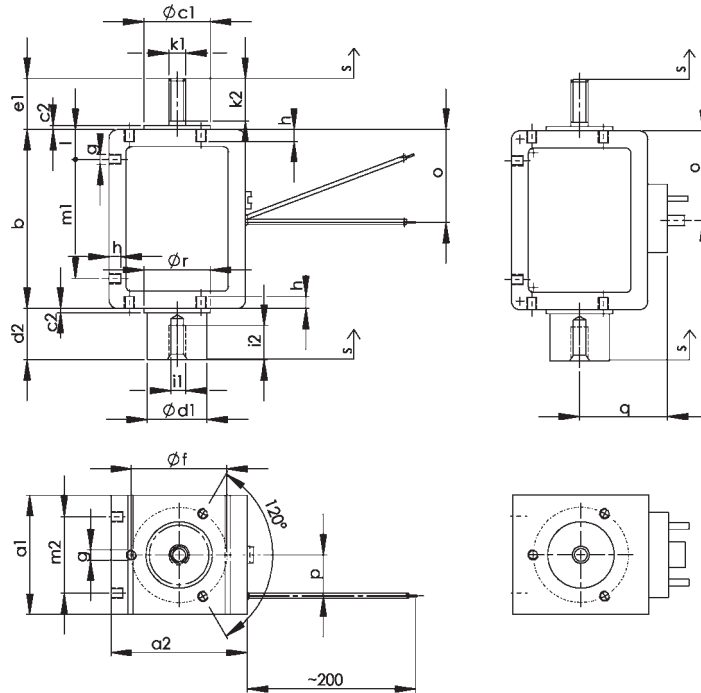

Drawing in a currentless condition

DC single direction linear solenoids

The DC single direction linear solenoids of the LCL030035 to LCL070080 series meet high standards in terms of performance and life expectancy. Compact dimensions and low power consumption, fast switching times and smooth operation characterise these series. New applications, which hitherto had been the exclusive province of heavy-duty DC linear solenoids for reasons of life expectancy, are now open to these devices. The frame is fabricated from precision steel tube. The plunger is guided in highly wear-resistant maintenance-free precision bearings on both sides. That means consistent solenoid performance throughout the long service life of these components. The solenoid has threaded fixing holes on one side or at the ends. The coil is supplied encapsulated as standard.

Parts at risk of corrosion are electrogalvanised to EN 12329. The plunger is electroplated to EN 12540.

The use of a plug-in connector to DIN EN 175301-803 (DIN 43650) with integral rectifier enables these solenoids to be operated directly in AC systems.

The plug-in connector is not included in the scope of supply and must be ordered separately (see "Accessories" data sheet).

We reserve the right to make changes without prior notice.

Dimensions of LCL030035 to LCL070080 (mm)

Designation	s	a1	a2	b	c1	c2	d1	d2	e1	f	g	h	i1	i2	k1	k2	l	m1	m2	o	p	q	r
LCL030035	15	30	35	45	17	2.5	15	18	15	24	M3	3.5	M4	8	M4	10	10	25	22	22.5	9	27	17
LCL040050	20	40	50	65	23	2.5	20	23	20	34	M4	5	M6	14	M6	15	12.5	40	30	32.5	9	34.5	23
LCL048060	25	48	60	75	28	2.5	25	28	25	40	M4	6	M8	15	M8	20	15	45	38	37.5	9	39.5	28
LCL060070	25	60	70	90	34	2.5	30	28	25	48	M5	6.5	M8	15	M8	20	15	60	48	45	9	44.5	34
LCL070080	30	70	80	105	39	2.5	35	33	30	56	M6	7	M10	22	M10	25	17.5	70	55	52.5	9	49.5	39

DC single direction linear solenoids

Types LCL030035 to LCL070080

Magnetic force and performance data:

duty cycle (%); stroke (mm); rated power (W); magnetic force (N); times (ms); linear work (Ncm); weight (kg)

Type	100% duty cycle			40% duty cycle			Plunger weight	Solenoid weight
	Rated power	Response time	Release time	Rated power	Response time	Release time		
LCL030035	10.5	75	35	18.0	65	30	0.055	0.25
LCL040050	18.0	135	45	38.0	90	40	0.125	0.66
LCL048060	22.0	220	55	45.0	140	50	0.23	1.16
LCL060070	28.0	350	67	65.0	210	62	0.41	2.04
LCL070080	39.0	450	81	95.0	315	80	0.63	3.25

Type	25% duty cycle			5% duty cycle			Plunger weight	Solenoid weight
	Rated power	Response time	Release time	Rated power	Response time	Release time		
LCL030035	26.5	50	25	100.0	30	20	0.055	0.25
LCL040050	57.0	70	33	234.0	45	25	0.125	0.66
LCL048060	75.0	95	40	308.0	50	30	0.23	1.16
LCL060070	98.0	130	48	470.0	55	36	0.41	2.04
LCL070080	150.0	175	58	680.0	60	43	0.63	3.25

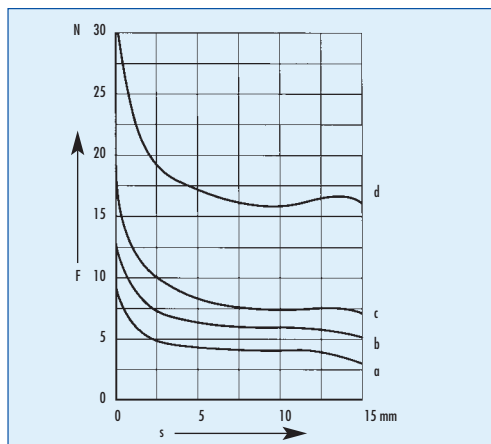

LCL030035 (43 11103D00)

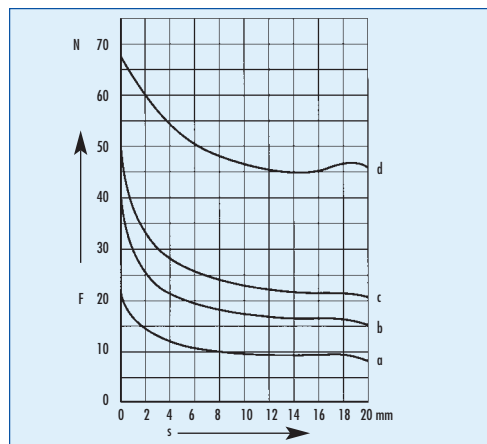

LCL040050 (43 11104E00)

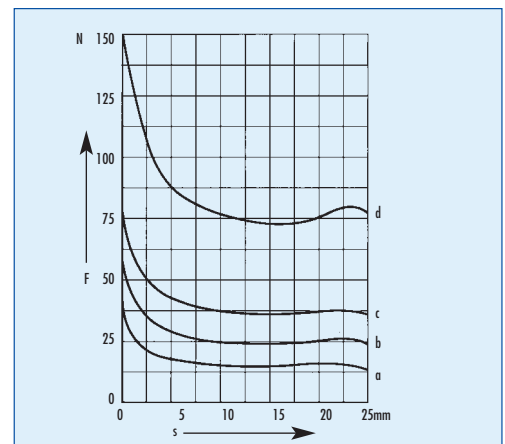

LCL048060 (43 11105D00)

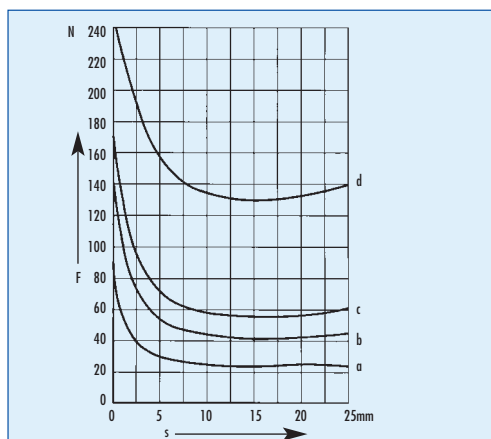

LCL060070 (43 11106D00)

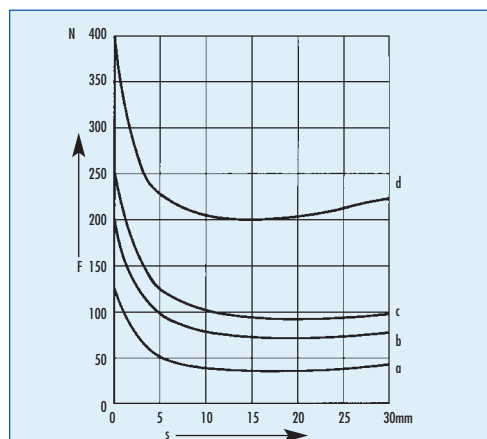

LCL070080 (43 11107D00)

Legend

- a: 100% duty cycle
- b: 40% duty cycle
- c: 25% duty cycle
- d: 5% duty cycle
- (...): former designation

Example of order

DC single direction linear solenoid
LCL070080
24 VDC, 100% duty cycle
with plug-in connection

Type LCL...



Options

- Fork joint
- Plug-in connector with bridge rectifier
- Switching device with overvoltage (rated power of solenoid max. 48 W)
- See "Accessories" data sheet

Design

Device: IP 54
 Connection: with device connector to DIN EN 175301-803, IP 65.
 Bellows at both ends.
 Insulation class B to DIN VDE 0580 (July 2000).

The magnetic forces specified are based on operating temperature and 90% of the rated voltage.

Standard rated voltage = 24 VDC

Standard duty cycle = 100%

Different supply voltages may lead to magnetic force values higher or lower than the specified values owing to the changing copper factor.

LCL030035 to LCL070080 with enhanced class of protection IP 54/65, encapsulated, with plug and bellows

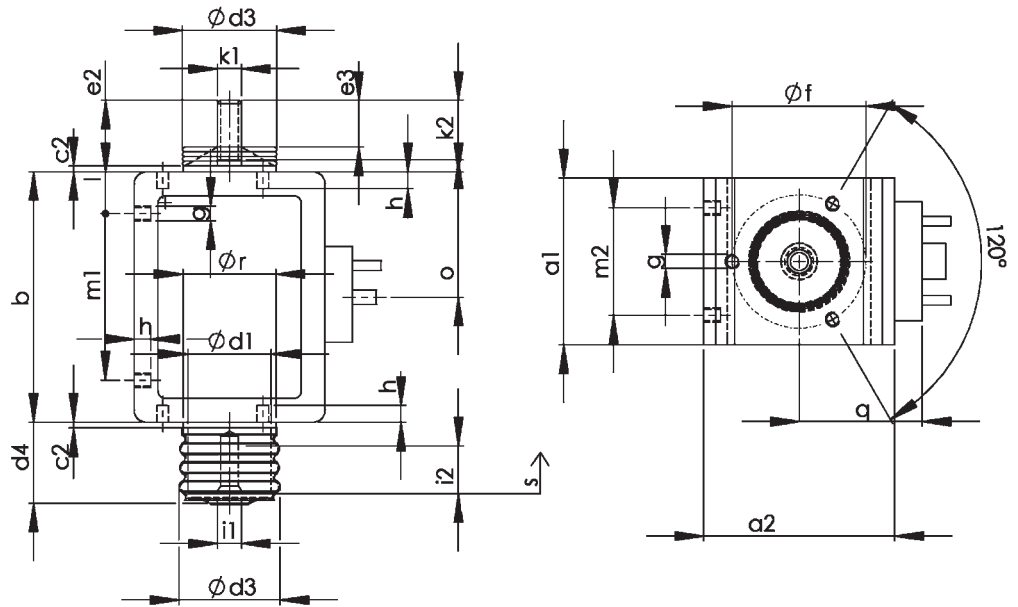

Drawing in a currentless condition

DC single direction linear solenoids

The DC single direction linear solenoids of the LCL030035 to LCL070080 series complying with class of protection IP 54/65 meet high standards in terms of performance and life expectancy. Compact dimensions and low power consumption, fast switching times and smooth operation characterise these series.

New applications, which hitherto had been the exclusive province of heavy-duty DC linear solenoids for reasons of life expectancy, are now open to these devices.

The frame is fabricated from precision steel tube. The plunger is guided in highly wear-resistant maintenance-free precision bearings on both sides. That means consistent solenoid performance throughout the long service life of these components. The solenoid has threaded fixing holes on one side or at the ends. The coil is supplied encapsulated as standard.

Parts at risk of corrosion are electrogalvanised to EN 12329. The plunger is electroplated to EN 12540.

The use of a plug-in connector to DIN EN 175301-803 (DIN 43650) with integral rectifier enables these solenoids to be operated directly in AC systems.

The plug-in connector is not included in the scope of supply and must be ordered separately (see "Accessories" data sheet).

We reserve the right to make changes without prior notice.

Dimensions of LCL030035 to LCL070080 (mm)

Designation	s	a1	a2	b	c1	c2	d1	d2	d3	d4	e1	e2	e3	f	g	h	i1	i2	k1	k2	l	m1	m2	o	p	q	r
LCL030035	15	30	35	45	17	2.5	15	18	26.5	24	15	19	10	24	M3	3.5	M4	8	M4	10	10	25	22	22.5	9	27	17
LCL040050	20	40	50	65	23	2.5	20	23	34	34	20	27	17	34	M4	5	M6	14	M6	15	12.5	40	30	32.5	9	34.5	23
LCL048060	25	48	60	75	28	2.5	25	28	40	38	25	36	20	40	M4	6	M8	15	M8	20	15	45	38	37.5	9	39.5	28
LCL060070	25	60	70	90	34	2.5	30	28	46	47	25	42	20	48	M5	6.5	M8	15	M8	20	15	60	48	45	9	44.5	34
LCL070080	30	70	80	105	39	2.5	35	33	53	55	30	50	25	56	M6	7	M10	22	M10	25	17.5	70	55	52.5	9	49.5	39

DC single direction linear solenoids Types LCL030035 to LCL070080

Magnetic force and performance data:

duty cycle (%); stroke (mm); rated power (W); magnetic force (N); times (ms); linear work (Ncm); weight (kg)

Type	100% duty cycle			40% duty cycle			Plunger weight	Solenoid weight
	Rated power	Response time	Release time	Rated power	Response time	Release time		
LCL030035	10.5	75	35	18.0	65	30	0.055	0.25
LCL040050	18.0	135	45	38.0	90	40	0.125	0.66
LCL048060	22.0	220	55	45.0	140	50	0.23	1.16
LCL060070	28.0	350	67	65.0	210	62	0.41	2.04
LCL070080	39.0	450	81	95.0	315	80	0.63	3.25

Type	25% duty cycle			5% duty cycle			Plunger weight	Solenoid weight
	Rated power	Response time	Release time	Rated power	Response time	Release time		
LCL030035	26.5	50	25	100.0	30	20	0.055	0.25
LCL040050	57.0	70	33	234.0	45	25	0.125	0.66
LCL048060	75.0	95	40	308.0	50	30	0.23	1.16
LCL060070	98.0	130	48	470.0	55	36	0.41	2.04
LCL070080	150.0	175	58	680.0	60	43	0.63	3.25

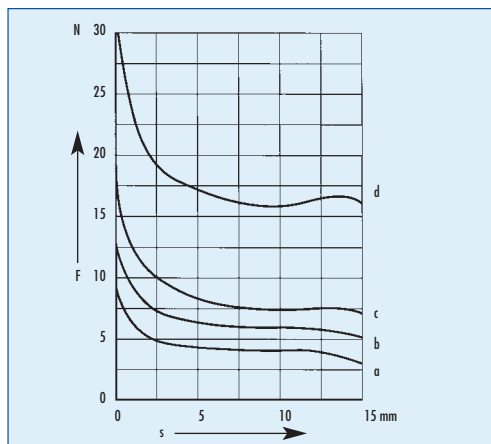

LCL030035 (43 11603D50)

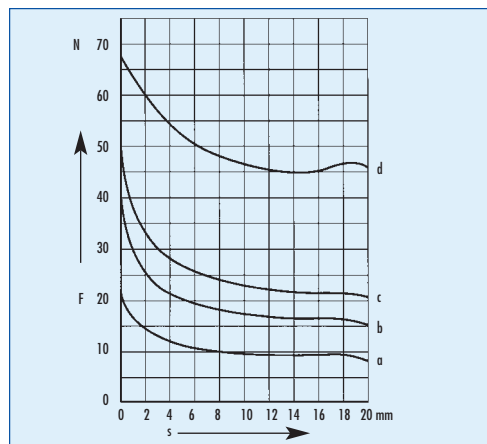

LCL040050 (43 11604E50)

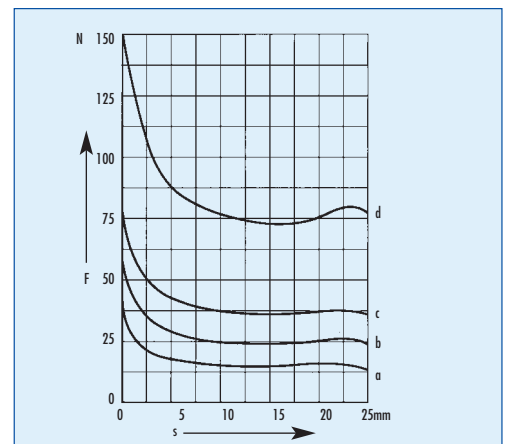

LCL048060 (43 11605D50)

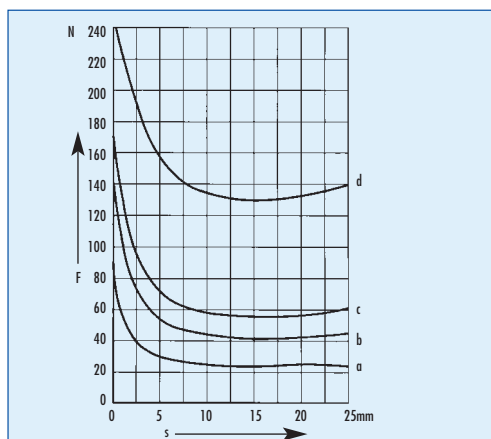

LCL060070 (43 11606D50)

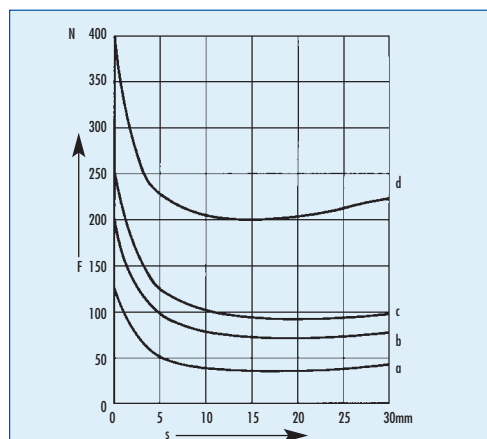

LCL070080 (43 11607D50)

Legend

- a: 100% duty cycle
- b: 40% duty cycle
- c: 25% duty cycle
- d: 5% duty cycle
- (...): former designation

Example of order

DC single direction linear solenoid
LCL040050
24 VDC, 100% duty cycle, encapsulated
with bellows and plug-in connection

Type LCM...

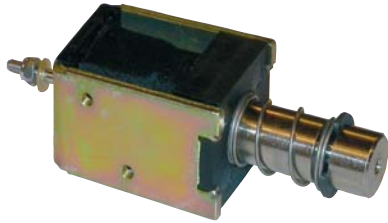

Options

- Return spring

Design

Lead wires, class of protection IP 00 to IEC 60529. Insulation class E to DIN VDE 0580 (July 2000). The magnetic forces specified are based on operating temperature and 90% of the rated voltage. Standard rated voltage = 24 VDC. Different voltages and stroke adjustments are available for a surcharge.

Different supply voltages may lead to magnetic force values higher or lower than the specified values owing to the changing copper factor.

LCM010015 to LCM025030

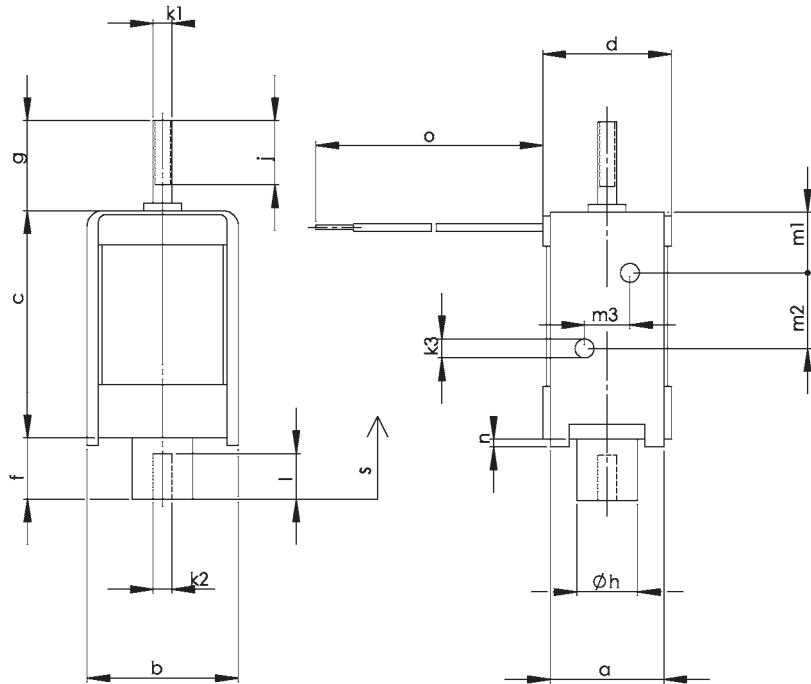

Drawing in a currentless condition

Monostable DC single direction linear solenoids

The monostable DC single direction linear solenoids of the LCM series are single-action solenoids for fast and slow intermittent duty with an ascending force-stroke characteristic. After the response phase, integral permanent magnets hold the plunger in the end position with a certain holding force in the de-energised state. The electromagnetic force is used for the linear movement and the permanent magnetic force to hold the plunger in the end position without the need for any electrical power. The return movement (overcoming the force of the permanent magnets) is triggered by a reversed, possibly lower, voltage pulse, depending on the magnitude of the external restoring force.

A bistable version can be created from this monostable version by using a compression spring. Monostable DC single direction linear solenoids are manufactured with a low-cost punched frame. The plunger is guided in highly wear-resistant maintenance-free precision bearings on both sides. The plunger stop must be fitted externally by the customer. The solenoid has threaded fixing holes on the side. Parts at risk of corrosion are electrogalvanised to EN 12329. The plunger has a phosphate conversion coating to EN 12476. The holding forces of the permanent magnets in the de-energised state are also reached at the operating temperature.

We reserve the right to make changes without prior notice.

Dimensions (mm)

Designation	a	b	c	d	e	f	g	h	j	k1	k2	k3	m1	m2	m3	l	n	o
LCM010015	10	15	25	12	2	4	10	6	7	M3	M3	M3	8	15	8	6	1	130
LCM015020	15	20	30	17	4	6	10	8	9	M3	M3	M3	8	10	6	6	1	130
LCM024030	24	30	40	25	8	10	10	12	9	M3	M3	M3	10	10	14	6	1	130
LCM025030	24	30	60	25	8	10	10	12	9	M3	M3	M3	10	20	14	6	1	130

Monostable DC single direction linear solenoids

Types LCM010015 to LCM025030

Magnetic force and performance data:

duty cycle (%); stroke (mm); power consumption, energisation and de-energisation (W); electromagnet and permanent magnet forces (N); times (ms); linear work (Ncm); weight (kg)

	100% duty cycle (1)				(2) Response time	40% duty cycle (1)				Plunger weight	Solenoid weight
	Power consumption energisation	de-energisation	Linear work			Power consumption energisation	de-energisation	Linear work			
LCM010015	2.6	1.3	0.2		45	4.5	1.3	0.24	37	0.005	0.022
LCM015020	3.7	2.8	0.76		60	7.1	2.8	1.12	56	0.011	0.045
LCM024030	6.6	5.4	4.2		80	13.5	5.4	5.8	75	0.032	0.15
LCM025030	9.1	7.3	7.4		83	19	7.3	10	75	0.045	0.225

	25% duty cycle (1)				(2) Response time	5% duty cycle (1)				Plunger weight	Solenoid weight
	Power consumption energisation	de-energisation	Linear work			Power consumption energisation	de-energisation	Linear work			
LCM010015	6	1.3	0.3		34	15.8	1.3	0.44	30	0.005	0.022
LCM015020	9.9	2.8	1.16		54	30.6	2.8	2	50	0.011	0.045
LCM024030	19.8	5.4	6.6		70	70.4	5.4	12.2	60	0.032	0.15
LCM025030	28	7.3	12		75	104	7.3	19.8	70	0.045	0.225

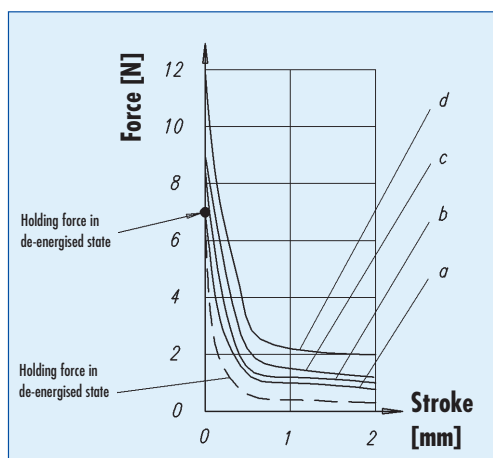

LCM010015 (SLP 2515)

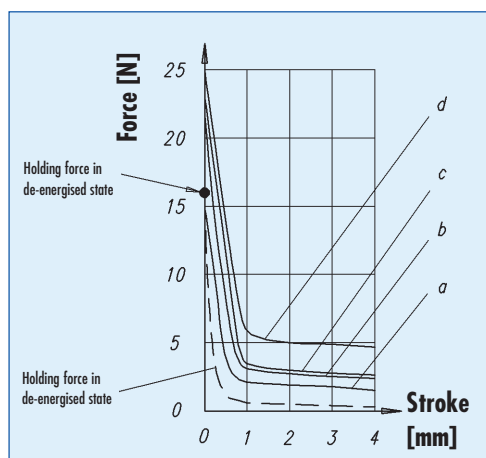

LCM015020 (SLP 3020)

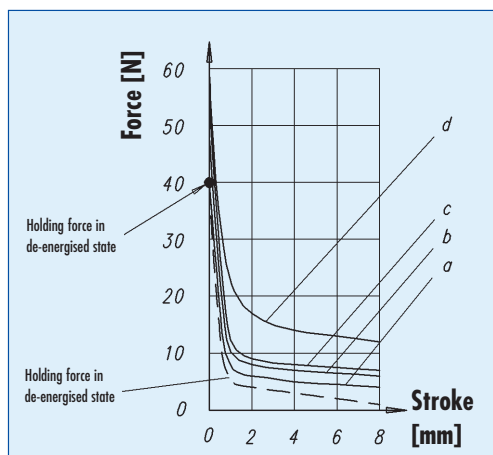

LCM024030 (SLP 4030)

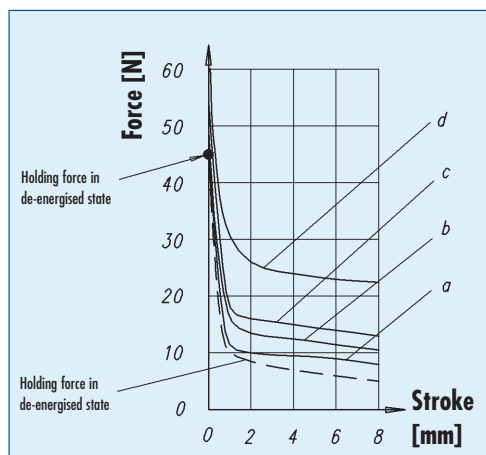

LCM025030 (SLP 6030)

Legend:

- a: 100% duty cycle c: 25% duty cycle
- b: 40% duty cycle d: 5% duty cycle
- (...): former designation

The values for the holding force in the de-energised state were calculated in the direction of maximum stroke.

(1) The return movement (overcoming the force of the permanent magnets) is triggered by a reversed, lower voltage pulse, depending on the magnitude of the external restoring force. The de-energisation power required has no time limit (100% duty cycle) and was calculated for a horizontal installation without external restoring forces. The optimum release voltage depends on system-related scatter effects and should be adjustable with low mechanical restoring forces provided by the customer.

(2) The response times were calculated with an additional load (70% of specified electromagnetic force at maximum stroke) at rated voltage and a series resistor for the simulated operating temperature of the coil.

Example of order

Monostable DC single direction linear solenoid
LCL015020
24 VDC
100% duty cycle

Kendrion Magnettechnik GmbH

August-Fischbach-Strasse 1
78166 Donaueschingen
Germany
Tel. +49 (0) 77 1 80 09-0
Fax +49 (0) 77 1 80 09-63 4
www.kendrionmt.com
info@kendrionmt.com

Engelswies Works

Fred-Hahn-Strasse 33
72514 Inzigkofen-Engelswies, Germany
Tel. +49 (0) 75 75 20 8-0
Fax +49 (0) 75 75 20 8-1 90
www.kendrionmt.com
info@kendrionmt.com

Kendrion Binder Magnete Ges.m.b.H.

8552 Eibiswald 269, Austria
Tel. +43 (0) 34 66 42 32 2-0
Fax +43 (0) 34 66 42 72 2
office@kendrion.com

Kendrion Binder Componentes, S.L.

Parque Industrial "El Poligono"
c./Rio Arba, 25
50410 Cuarte de Huerva /
Zaragoza, Spain
Tel. +34 9 76 46 30 40
Fax +34 9 76 46 30 42
guadalupe.cabrera@kendrion.com

Technical offices (Germany)

Kendrion Magnettechnik GmbH

Technisches Büro West
Bottroper Strasse 15
46244 Bottrop
Tel. +49 (0) 20 45 41 34 34
Fax +49 (0) 20 45 40 64 26
www.kendrionmt.com
wilhelm.martin@kendrion.com

Kendrion Magnettechnik GmbH

Technisches Büro Nord
Delmer Bogen 71
21614 Buxtehude
Tel. +49 (0) 41 61 73 37 77
Fax +49 (0) 41 61 60 07 39 3
www.kendrionmt.com
reinhard.lenser@kendrion.com

Representatives (Germany)

VOR-Steuerungstechnik

Friedrich Rudolph GmbH
Wichernstrasse 9
50389 Wesseling
Tel. +49 (0) 22 36 94 27 88
Fax +49 (0) 22 36 84 27 86
info@vor.de
www.vor.de

Claus Kähne

Industrievertretungen GmbH

Kurmainzer Str. 199a
65936 Frankfurt
Tel. +49 (0) 69 34 05 90 20
Fax +49 (0) 69 34 05 90 27
kaehne.gmbh@t-online.de

RUG

Regler- und Gerätebau GmbH

Karl-Ehmann-Str. 50
73037 Göppingen
Tel. +49 (0) 71 61 85 70
Fax +49 (0) 71 61 85 72 9
jurenka@r-u-g.de

Antriebstechnik Laipple GmbH

Burgstrasse 84
73614 Schorndorf
Tel. +49 (0) 71 81 97 94 92
Fax +49 (0) 71 81 97 94 93
antriebstechnik-laipple@t-online.de

Winfried Kerner GmbH

Ingenieurbüro
Kiebitzweg 11
85375 Neufahrn
Tel. +49 (0) 81 65 52 45
Fax +49 (0) 81 65 62 12 8
www.kerner-gmbh.de
kerner-gmbh@t-online.de

Hans-Christian Pilder

Wirtschaftsingenieur
Ablers 119
88175 Scheidegg
Tel. +49 (0) 17 17 23 13 31
Fax +49 (0) 83 81 94 87 62
www.kendrionmt.com
kendrion@pilder.de

Representatives (worldwide)

Austria

Kendrion Binder Magnete
Vertriebs. GmbH
Estermannstrasse 27
4020 Linz
Tel. +43 (0) 7 32 77 63 83
Fax +43 (0) 7 32 78 35 58
www.kendrion-binder.at
office@kendrion-binder.at

Belgium, Luxembourg

Bintz technics N.V.
Brixtonlaan 25
1930 Zaventem
Tel. +32 (0) 2 7 20 49 16
Fax +32 (0) 2 7 20 37 50
www.bintz-technics.be
info@bintz.be

Canada

VL Motion Systems Inc.
1105 Goodson Cres.
Oakville, Ontario L6H4A7
Tel. +01 905 842 0244
Fax +01 905 844 1293
vince@vlmotion.com

Denmark

Lind Jacobsen & Co. A / S
Blokken 62
3460 Birkerød
Tel. +45 (0) 45 81 82 22
Fax +45 (0) 45 82 10 22
www.lind-jacobsen.dk
strong@lind-jacobsen.dk

Desim Elektronik APS

Tasingevej 15
9500 Hobro
Tel. +45 (0) 70 22 00 66
Fax +45 (0) 70 22 22 20
www.desim.dk
desim@desim.dk

Farstrup & Benzon A/S

Engholmvej 1, Saunte
3100 Hombæk
Tel. +45 (0) 49 70 40 33
Fax +45 (0) 49 70 40 32
www.safeline.dk
f&b@safeline.dk

Finland

SKS-mekaniikka Oy
Martinkyläntie 50
P.O. Box 122
01721 Vantaa
Tel. +358 (0) 98 52 66 1
Fax +358 (0) 98 52 68 20
www.sks.fi
mekaniikka@sks.fi

Moeller Electric Oy

Sahaajankatu 24
00811 Helsinki
Tel. +358 (0) 9 25 25 21 00
Fax +358 (0) 9 25 25 21 77
www.moeller.fi
info.fin@moeller.net

France

Binder Magnetic
1, Allée des Barbannières
92632 Gennevilliers Cedex
Tel. +33 (0) 1 46 13 80 80
Fax +33 (0) 1 46 13 80 99
info@binder-magnetic.fr

Italy

SPII S.p.A
Via Don Volpi 37
21047 Saronno (VA)
Tel. +39 (0) 2 96 22 921
Fax +39 (0) 2 96 09 611
www.spil.it
info@spil.it

Netherlands

Solar Electro B. V.
Effect 5
6921 RG Duiven
Tel. +31 (0) 26 3 65 29 11
Fax +31 (0) 26 3 65 23 90
www.solarelektro.nl
algemeen@solarelektro.nl

GTI Electroproject B.V.

Grote Tocht 102
1507 CE-Zaandam
Tel. +31 (0) 75 68 11 11 1
Fax +31 (0) 75 63 54 00 3

Norway

Industrielementer AS
Postboks 43
1556 Son
Tel. +47 (0) 64 95 81 32
Fax +47 (0) 64 98 29 29
www.industrielementer.no
post@industrielementer.no

siv. ing. J.F. Knudtzen A/S

Billingstadsletta 97
1396 Billingstad
Tel. +47 (0) 66 98 33 50
Fax +47 (0) 66 98 09 55
www.jfk.no
firmapost@jfk.no

South Africa

Magnete Service Binder
P.O. Box 44051
2104 Linden
Tel. +27 (0) 11 46 2-32 08
Fax +27 (0) 11 46 2-33 04
info@binder.co.za

Spain, Portugal

Binder Magnete Iberica S.L.
Apartado de Correos 116
Costa Zefir 99
43892 Miami-Playa (Tarragona)
Tel. +34 9 77 17 27 07
+34 9 77 81 04 29
Fax +34 9 77 17 01 82
www.binder-es.com
binder@binder-es.com

Sweden

Industrikomponenter AB

Industrivägen 12
17148 Solna
Tel. +46 (0) 8 51 48 44 00
Fax +46 (0) 8 51 48 44 01
www.inkom.se
info@inkom.se

Uno Gunnarsson / Höör AB

Box 64
24322 Höör
Tel. +46 (0) 4 13 24 54 0
Fax +46 (0) 4 13 23 18 3

Moeller Electric AB

Granitvägen 2
55303 Jönköping
Tel. +46 (0) 86 32 30 00
Fax +46 (0) 86 32 32 99

Switzerland

Kendrion Binder Magnet AG

Albisstrasse 26
8915 Hausen a/A
Tel. +41 (0) 17 64 80 60
Fax +41 (0) 17 64 80 69
www.kendrion.ch
binder.magnet@kendrion.com

United Kingdom

Kendrion Binder Magnete (U.K.) Ltd.

Huddersfield Road, Low Moor
Bradford, West Yorkshire,
BD12 0TQ
Tel. +44 (0) 12 74 60 11 11
Fax +44 (0) 12 74 69 10 93
www.kendrion-binder.co.uk
sales@kendrion-binder.co.uk

USA

Gradframe Inc.

950 E. Baldwin Road
Palatine IL 60074
Tel. +01 847 991 1788
Fax +01 847 991 1788
gradframe@aol.com

This publication is for information purposes only and should not be regarded as a binding presentation of the products, unless we expressly confirm otherwise. We reserve the right to make changes to the specification, form, price and availability of the products described herein at any time without prior notice. Each product may be used only for its intended purpose. We reserve to make changes to the product design.