



P I X S Y S
electronica

ATR 121
ATR 141



- **Regolatore**
- **Controller**

Manuale Installatore
User manual



Contents

1 - SECTION FOR USERS	4
2 - DISPLAYS AND KEYS	4
3 - CHANGE OF SETPOINT VALUE	5
4 - LIST OF ERROR MESSAGES.....	6
5 - SECTION FOR INSTALLERS.....	6
6 - INTRODUCTION	6
7 - ORDERING CODES.....	7
8 - TECHNICAL DATA.....	8
9 - ELECTRICAL WIRINGS.....	9
10 - WIRING DIAGRAM ATR121 / ATR141.....	10
11 - ALARM INTERVENTION MODES	13
12 - MODIFY CONFIGURATION PARAMETERS.....	17
13 - CONFIGURATION PARAMETERS.....	18
14 - TUNING.....	30
15 - MANUAL START OF TUNING.....	31
16 - AUTOTUNING	31
17 - FUNCTION LATCH ON	32
18 - FUNCTION NEUTRAL ZONE.....	34
19 - SERIAL COMMUNICATION	35
20 - MEMORY CARD (OPTIONAL)	39
21 - LOADING DEFAULT VALUES.....	41
22 - SUPERVISORY SYSTEM WITH CONTROLLERS ATR121 / 141 ..	42
23 - CONFIGURATION MEMORANDUM	43
24 - NOTES / UPDATE.....	45

Sommario

25 - SEZIONE UTENTE.....	46
26 - VISUALIZZATORI E TASTI	46
27 - CAMBIO DEL SETPOINT	47
28 - SEGNALAZIONE ANOMALIE.....	48
29 - SEZIONE INSTALLATORE	49
30 - INTRODUZIONE.....	49
31 - COMPOSIZIONE DELLA SIGLA	50
32 - CARATTERISTICHE	51
33 - COLLEGAMENTI ELETTRICI.....	53
34 - SCHEMA DI COLLEGAMENTO ATR121 / ATR141.....	53
35 - MODI D'INTERVENTO ALLARME.....	57
36 - MODIFICA PARAMETRI DI CONFIGURAZIONE	60
37 - TABELLA PARAMETRI DI CONFIGURAZIONE.....	62
38 - TUNING.....	75
39 - LANCIO DEL TUNING MANUALE.....	76
40 - TECNICA DI TUNING AUTOMATICO	77
41 - FUNZIONE LATCH ON.....	77
42 - FUNZIONE BANDA MORTA.....	79
43 - COMUNICAZIONE SERIALE.....	80
44 - MEMORY CARD (OPZIONALE).....	84
45 - CARICAMENTO VALORI DI DEFAULT.....	86
46 - SUPERVISIONE CON ATR121 / 141	87
47 - PROMEMORIA CONFIGURAZIONE	88
48 - NOTE / AGGIORNAMENTI.....	90
49 - IDENTIFICATION DU MODÈLE	91
50 - DONNÉES TECHNIQUES.....	92
51 - RACCORDS ÉLECTRIQUES	94

1 - SECTION FOR USERS

2 - DISPLAYS AND KEYS

Display normally shows process value (ex. measured temperature), but can also visualize setpoints or value of entering data

Visualize set, increase set or scroll parameters (whith fast advancement)

Visualize set, decrease set, scroll parameters. (whith fast advancement)



Visualize setpoints (ex. programmed temperature):
press once for SET1 (Led Out1 flashes),
press twice for SET2 (Led Out2 flashes).
In configuration mode press with arrow keys to modify value of visualized parameter.

Flashing when setpoint is visualized on display and can be modified.
ON when output is active.









ON when controller responds to a Master request over serial line RS485



Enter configuration of parameters (by password).
Activate special functions.

3 - CHANGE OF SETPOINT VALUE

To modify the setpoint value, press  key or one of the arrow-keys: led OUT1 flashes and it is now possible to enter/modify setpoint value by pressing the arrow-keys.

	Press	Display	Do
1	 or  or 	Display shows control setpoint ; Led OUT1 flashes.	Press  or  To modify setpoint (fast advancement available). Approx. 4 seconds after last modify, display shows again process value (value read by sensor input).
2		Display shows alarm setpoint and led OUT2 flashes.	Press  or  to increase or decrease setpoint value. When the keys are released, the new value is automatically stored and in a few seconds display shows again process value.

4 - LIST OF ERROR MESSAGES

If the plant does not work properly, the controller stops the running cycle and shows the anomaly.

For example the controller will notice the failure of a thermocouple displaying E-5 (flashing).

For further error signs check the list below.

Error	Cause	Do
E-01	Programming error EPROM.	Contact technical service
E-02	Cold junction failure or room temperature out of range	Contact technical service
E-04	Wrong configuration data. Possible lost of calibration values	Check configuration parameters
E-05	Open thermocouple or room temperature out of range	Check sensors connection and their integrity
E-08	Missing calibration data	Contact technical service

5 - SECTION FOR INSTALLERS

6 - INTRODUCTION

Thanks for choosing a Pixsys Controllers. Various models with 3-4 digits display make the controller suitable for a wide range of applications with temperature, humidity, pressure sensors and linear potentiometers. Output options include two relays and SSR, but the unit is configurable also as visualizer/indicator for applications not requiring control or alarm outputs. PID control with Autotuning function enables to adapt control algorithm to the plant. For applications with linear potentiometers the function LATCH ON allows a quick calibration. Memory-card is available to copy configuration parameters and to keep record of them.

The tables below allow to select the required model.

7 - ORDERING CODES

Ordering codes model ATR121

ATR121-	xx	x	
<i>Power supply</i>	AD		12...24Vac \pm 10% 50/60Hz 12...35Vdc
	A		24 Vac \pm 10% 50/60 Hz
	B		230 Vac \pm 10% 50/60 Hz
	C		115 Vac \pm 10% 50/60 Hz
<i>Serial communication</i>	A	T	RS485 - protocol Modbus RTU slave. Relay Q2 not available in this model, alarm available on SSR output. Only Code AT: 24Vac +/- 10% 50/60 Hz Only Code ADT: 12...35Vdc
	AD	T	

Ordering codes Model ATR141

ATR141-	xx	x	
<i>Power supply</i>	AD		12...24Vac \pm 10% 50/60Hz 12...35Vdc
	A		24 Vac \pm 10% 50/60 Hz
	B		230 Vac \pm 10% 50/60 Hz
	C		115 Vac \pm 10% 50/60 Hz
<i>Serial communication</i>	A	T	RS485 -protocol Modbus RTU slave. Relay Q2 not available in this model, alarm available on SSR output. Only Code AT: 24Vac +/- 10% 50/60 Hz Only Code ADT: 12...35Vdc
	AD	T	

8 - TECHNICAL DATA

Main features

<i>Displays</i>	3 digits (0,56 inches) on ATR121 4 digits (0,40 inches) on ATR141 + 3 Leds (Out1 , Out2 , Fnc)
<i>Operating temperature</i>	0-40°C - humidity 35..95uR%
<i>Sealing</i>	Front panel IP65 (with gasket) / Box IP30 / Terminal blocks IP20
<i>Material</i>	ABS UL94V2 self- extinguish
<i>Weight</i>	Approx. 100 gr.

Hardware data

<i>Analogu e input</i>	AN1 Configurable via software Thermocouples: Type K, S, R, J. Thermoresistance: PT100, PT500, PT1000, Ni100, PTC1K, NTC10K (β 3435K) Linear: 0-10V ($R_i \geq 110 \text{ K}\Omega$) 0-20, 4-20mA ($R_i \leq 4.7 \Omega$) Potentiometers: $\leq 6\text{K}\Omega$, $\leq 150\text{K}\Omega$	Tolerance 25°C 0.5 % \pm 1 digit for thermocouples and RTD Cold junction 0.2°C/°c of ambient temperature 0.2% \pm 1 digit for V, mA
<i>Relay outputs</i>	2 Relays OUT1 :10A resistive on 8A resistive with internal transformer OUT2 : 5A resistive	AD codes,
<i>SSR output</i>	8 Volt 20mA for version A/B/C 15 Volt 30mA for version AD (alim. 12Vac) 30 Volt 30mA for version AD (alim. 24Vac)	

Software data

<i>Control algorithm</i>	On/OFF with hysteresis or P.I.D. with Autotuning
<i>Data protection</i>	Configuration password, quick programming by Memory card

8.1 Sizes and installation

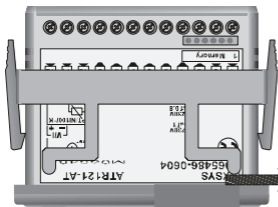

Dima di foratura
28.5 x 70.5 mm
Frontal panel cut-out

Spessore suggerito
2÷8 mm
Suggested thickness

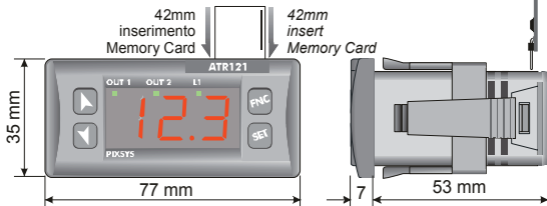

9 - ELECTRICAL WIRINGS



Although this controller has been designed to resist the noises in an industrial environment, please notice the following safety guidelines:

- Separate control lines from the power wires.
- Avoid the proximity of remote control switches, electromagnetic meters, powerful engines.
- Avoid the proximity of power groups, especially those with phase control

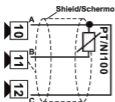

For thermoresistances PT100, NI100

- For a three-wires PT100 use cables with the same diameter
- For a two-wires PT100 short-circuit terminals 10 and 12.

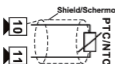

For thermoresistances NTC, PTC, PT500, PT1000 e potentiometers

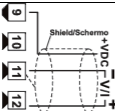

For linear signals V/mA

- Comply whit polarity

10.4 Examples of connection for linear input

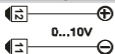

For signals 0...10V
Comply with polarity
 $R_i \geq 110K\Omega$

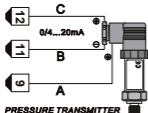

For signals 0/4...20mA with **three-wires sensors**

Comply with polarity
A= sensor supply

! Check power supply requirements on technical data sheet of sensor!

Capacity 12...24V / 30mA for models AD

Capacity 8V / 20mA for models A-B-C

B= sensor ground

C= sensor output

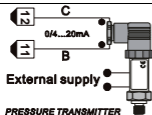

For signals 0/4...20mA with **external power of sensor**
 Comply with polarity
 B= sensor ground
 C= sensor output

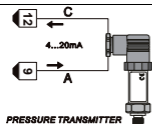

For signals 0/4...20mA with **two-wires sensors**
 Comply with polarity
 A= sensor supply
 ⚠ Check power supply requirements on technical data sheet of sensor!
 Capacity 12...24V / 30mA for models AD
 Capacity 8V / 20mA for models A-B-C
 C= sensor output

10.5 Relay outputs

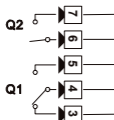

- Q1 capacity 8A/250V~ (**Models A-B-C**)
resistive (manoeuvre 2×10^5 min - 8A/250V~)
- Q1 capacity 10A/250V~ (**Model AD**)
resistive (manoeuvre 2×10^5 min - 10A /250V~)
- Q2 capacity 5A/250V~ resistive
(manoeuvre 2×10^5 min a 3A /250V~)

10.6 SSR output



Capacity 12...24V/30mA on model AD
 Capacity 8V/20mA on models A-B-C
 Command output if configured as SSR

10.7 Serial communication

Models ATR121-xT , ATR141-xT

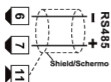

RS485, protocol MODBUS-RTU

⚠ Do not use LT (line termination) resistors

11 - ALARM INTERVENTION MODES

11.1 Absolute Alarm or Threshold Alarm (**AAAA** selection)

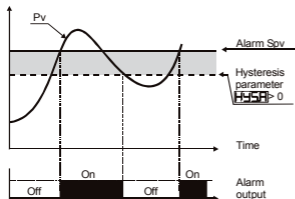

Absolute alarm with controller in heating functioning (Par.11 **FEQ** selected **HERE**) and hysteresis (absolute value)

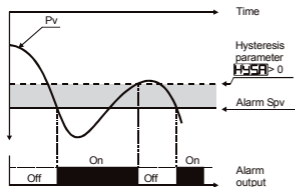

Absolute alarm with controller in cooling functioning (Par.11 **FEQ** selected **COOL**) and hysteresis (absolute value)

11.2 Absolute Alarm or Threshold Alarm Referring to Setpoint Command (**ALAS** selection)

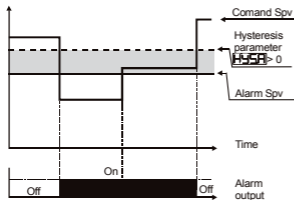

Absolute alarm refers to the command set, with the controller in heating functioning

(Par.11 **REG** selected **HEAT**) and hysteresis (absolute value)

The command set can be changed by pressing the arrow keys on front panel or using serial port RS485 commands.

11.3 Band Alarm (**ALBA** selection)

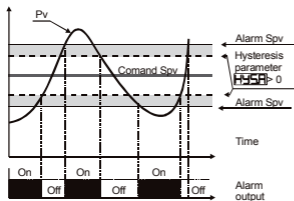

Band alarm with hysteresis
N.B.: hysteresis value can't be less than "0"

11.4 Upper Deviation Alarm (**ALAS** selection)

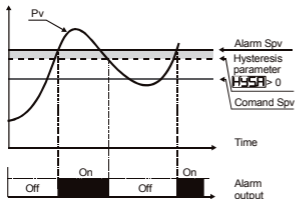

Upper deviation alarm value of alarm setpoint greater than "0" and hysteresis value greater than "0" (Par.23 **HYSA** > 0)
 N.B.: hysteresis value can't be less than "0"

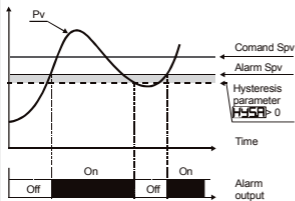

Upper deviation alarm value of alarm setpoint less than "0" and hysteresis value greater than "0" (Par.23 **HYSA** > 0)
 N.B.: hysteresis value can't be less than "0"

11.5 Lower Deviation Alarm (ALBA selection)

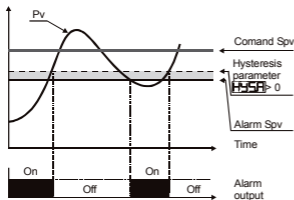

Lower deviation alarm value of alarm setpoint greater than "0" and hysteresis value greater than "0"

(Par.23 $HYSFA > 0$).

N.B.: hysteresis value can't be less than "0"

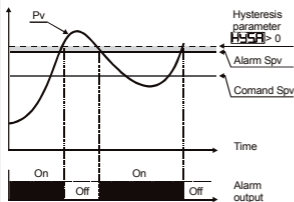











Lower deviation alarm value of alarm setpoint less than "0" and hysteresis value greater than "0"

(Par.23 $HYSFA > 0$).

N.B.: hysteresis value can't be less than "0"

12 - MODIFY CONFIGURATION PARAMETERS











The configuration menu of the unit is password protected to prevent unauthorised access to the instrument set-up. Password cannot be modified.





	Press	Display	Do
1		After 5 seconds display shows  , first digit on the left is flashing.  on ATR141	
2		Increase first digit to "1"	Press  to reach following digit and enter configuration password "123" for ATR121 or "1234" for ATR141
3		Display shows first configuration parameter  for ATR121  for ATR141	
4	 	The arrow-keys allow the movement through the configuration table in both forward and backward directions.	Select parameter to modify, press  to visualize it and use arrow keys to modify value.

13 - CONFIGURATION PARAMETERS

P	Display	Description	Range		
			ATR121	ATR141	Description
1	ATR121 <input type="text" value="COU"/> ATR141 <input type="text" value="COU"/>	Select type of control output	<input type="text" value="012"/>	<input type="text" value="0102"/>	Control Q1 Alarm Q2 (default)
			<input type="text" value="015"/>	<input type="text" value="0155"/>	Control Q1 Alarm SSR
			<input type="text" value="55r"/>	<input type="text" value="55r"/>	Control SSR Alarm Q1
			<input type="text" value="02.1"/>	<input type="text" value="020.1"/>	Control Q2 Alarm Q1
			<input type="text" value="5Er"/>	<input type="text" value="5Er.u"/>	Open Q1 Close Q2 (SSR on versions with RS485)
2	<input type="text" value="5Er"/>	Select type of connected sensor  <u>only for AD models :</u> To assure optimal working of the unit, use ground-isolated sensors. Otherwise use single isolated transformers for each controller.	<input type="text" value="tct"/>	<input type="text" value="tc. t"/>	TC type K -260...1360 °C (default)
			<input type="text" value="tcS"/>	<input type="text" value="tc. S"/>	TC type S -40...1760°C
			<input type="text" value="tcr"/>	<input type="text" value="tc. r"/>	TC type R -40...1760°C
			<input type="text" value="tcJ"/>	<input type="text" value="tc. J"/>	TC type J -200...1200°C
			<input type="text" value="Pt"/>	<input type="text" value="Pt"/>	Pt100-200..600°C
			<input type="text" value="Pt1"/>	<input type="text" value="Pt1"/>	Pt100-200..140°C
			<input type="text" value="ni"/>	<input type="text" value="ni"/>	Ni100 -60..180°C
			<input type="text" value="ntc"/>	<input type="text" value="ntc"/>	Ntc 10KΩ -40...125°C
			<input type="text" value="Ptc"/>	<input type="text" value="Ptc"/>	Ptc 1KΩ -50...150°C
			<input type="text" value="PtS"/>	<input type="text" value="PtS"/>	Pt500- 100...600°C

			P 1F	P 1F	Pt1000 -100...600°C
			Q 10	Q 10	0...10V
			Q 20	Q 20	0...20mA
			Y 20	Y 20	4...20mA
			Po 1	Pot 1	Potenzimeter ≤ 6KΩ
			Po 2	Pot 2	Potenzimeter ≤ 150KΩ
3	dP.	Select position	0	0	no decimal point (default)
		decimal point	00	00	1 decimal point
			000	000	2 decimal points
			-----	0000	3 decimal points
4	La 5	Lower limit selectable for setpoint value	-199.. +999 digit	-999.. +9999 digit	Degrees for temperature sensors Digits for linear signals and potentiometers (default 0)
5	Ha 5	Upper limit selectable for setpoint value	-199... +999 digit	-999... +9999 digit	Degrees for temperature sensor. Digits for linear signals and potentiometers (default: 999 for ATR121 and 1750 for ATR141)

6		<p>Lower limit signals V/mA Example: for input 4...20mA, enter on this parameter the value corresponding to 4mA</p>	<p>-199... +999 digit</p>	<p>-999... +9999 digit</p>	<p>(default 0)</p>
7		<p>Upper limit signals V/mA Example: for input 4...20mA, enter on this parameter the value corresponding to 20mA</p>	<p>-199... +999 digit</p>	<p>-999... +9999 digit</p>	<p>(default 999)</p>
8	ATR121 	<p>Function Latch On (Automatic setting of limits for potentiometers and linear signals)</p>			<p>Disabled (default)</p>
					<p>Standard</p>
	ATR141 				<p>virtual zero stored</p>
					<p>virtual zero at start</p>















9	ATR121  ATR141 	Offset calibration. This value is added to the process value visualized on display (usually correcting the ambient temperature)	-19.9... +99.9 units	-99.9... +99.9 units	Tenths of degree for temperature. Digits for linear signals and potentiometers (default 0.0)
10	ATR121  ATR141 	Gain calibration of sensor input (The visualized number is multiplied for this % value to calibrate process value)	-19.9% +99.9 %	-99.9% +99.9%	(default 0.0)

11	FEG	Type of control	HEA	HEAT	Heating (N.O.) (default)
			COO	COOL	Cooling (N.C.)
			Nr.	Nr.	Absolute alarm with manual reset of contact
			NrN	NrN	Absolute alarm with manual reset; status of relay stored in case of switch-off
			Hoo	Hoo	Heating mode with PID set to 0 if process value is above setpoint value
12	SCC	Type of contact for control output in case of error	CO		Open contact safety (default)
			CC		Closed contact safety
13	ATR121 Ld I	State of led OUT1 according to relevant contact	CO		On with open contact
	ATR141 LEd I		CC		On with closed contact (default)
14	ATR121 HYC ATR141 HYSc	ON/OFF hysteresis or dead band for P.I.D. control	-199... +999 digits	-999... +999 digits	Tenth of degree for temperature sensor. Digits for linear signals and potentiometers (default 0.0)

15	<input type="text" value="Pb"/>	Proportional band Width of the process expressed as units (°C if temperature)	0...999	0...9999	0 = On/Off °C (temp.) digit (V/mA) (default 0)
16	<input type="text" value="Ei"/>	Integral time. Inertia of the process expressed as seconds	0-999	0-9999	seconds (0 excludes Integral) (default 0)
17	<input type="text" value="Ed"/>	Derivative time for P.I.D. Usually ¼ of integral time	0...999	0...9999	seconds (0 excludes Derivative) (default 0)
18	<input type="text" value="Ec"/>	Cycle time for time-proportioning output (usually over 10s for contactors, 1s for SSR, value declared by manufacturer for motorised valves)	1-300		Seconds. Entering 0 the cycle time will be 100ms (default 10)

19	AL	Operating mode of alarm. Setpoint for alarm is SET2	AA	ALA	Absolute related to process /Treshold alarm (default)
			Ab	ALb	Band alarm
			AdS	ALdS	Deviation high
			AdL	ALdL	Deviation low
			AAS	ALAS	Absolute related to setpoint 1
			COO	COOL	Command output for cooling action for PID Heating/Cooling mode ¹
Ar.	Ar.	Absolute – with manual reset (after alarm activation, press FNC key to reset the output)			

¹ Parameters 33,34,35,36 are considered only if double action Heating/ Cooling (AL selected as COO) and value of Ph other than 0.

					Absolute with manual reset (after alarm activation, press FNC key to reset the output) ; status of relay stored in case of switch-off
20		State of contact for alarm output and type of operating		Normally open, active at Start (default)	
				Normally closed, active at Start	
				Normally open, active at alarm setpoint ¹	
				Normally closed, active at alarm setpoint ¹	
21		State of contact for alarm output in case of error		Open contact safety (default)	
				Closed contact safety	
22	ATR121  ATR141 	State of led OUT2 according to relevant contact		ON with open contact	
				ON with closed contact (default)	

¹ At starting the output is disabled in case of any alarm condition. After the alarm has been solved, output will be activated only if alarm condition should occur again.

23	ATR121 HYA ATR141 HYSA	Alarms hysteresis	-199... +999 digits	-999... +9999 digits	Tenth of degree for temperature sensor. Digits for linear signals and potentiometers (default 0.0)
24	ATR121 dEA ATR141 dELA	Alarm delay	-180...+180		seconds Negative: delay at alarm deactivation Positive: delay at alarm activation (default 0)
25	PSE	Allow/deny modification of setpoint values by frontal keyboard	FrE	FrEE	Allow modification of all setpoints (default)
			PrS	ProS	Control setpoint SPV1 protected
			PrA	ProA	Alarm setpoint SPV2 protected
			ALL	ALL	Access denied to all setpoints
26	ATR121 FIL ATR141 FILE	Software filter. Number of readings to calculate the comparison value PV-SPV	1-15		Number of means (Sampling frequency 15Hz) (default 10)

27	ATR121 Eun	Select type of auto-tuning	oFF	oFF	Disabled (default)
	ATR141 EunE		Aut	Auto	automatic
			NA _n	NA _n	manual start of Tuning
28	ATR121 Fnc	Select operating mode and visualization options	dSE	dSEt	Double setpoint (default)
	ATR141 Func		SSE	SSEt	Single setpoint
			u IS	u .S	Indicator only (no relay output)
			Fb _n	Fb _n	Function Neutral zone/Dead band
			NA ,	NA ,n	Hide process and setpoint values
			ldo	ldo _n	Domotics 1 : switch off displays and LEDs after 15" since last pressing of keys
			2do	2do _n	Domotics 2 : switch off only display after 15" since last pressing of keys
			3do	3do _n	Domotics 3 : switch off the display except for decimal point after 15" since last pressing of keys

			SSu	SSu	Single setpoint: setpoint always visualized on display. Press  to visualize process value (flashing)
29	ATR121 GrA ATR141 GrAd	Type of degree	0C	0C	Celsius (default)
			0F	0F	Fahrenheit
30	ATR121 bdr ATR141 bdrT	Baud rate of serial communication	0b1	0db1	300 bit/s
			0b2	0db2	9600 bit/s
			0b3	0db3	19200 bit/s (default)
			0b4	0db4	38400 bit/s
31	ATR121 Add ATR141 Addr	Slave address	1-254		(default 254)
32	ATR121 dES ATR141 dLSc	Delay serial communication	0-100		Milliseconds (default 20)
33	ATR121 coF ATR141 cooF	Select type of cooling fluid in PID Heating/Cooling mode : modifying	Air	Air	Set TC2 as 10s and P.B.M as 1.00. (default)
			Oil	Oil	Set TC2 as 4s and P.B.M as 1.25.

	See remark 1	this parameter, Pb1 and Tc2 will assume one of the listed values	H2o Water	Set TC2 as 2s and P.B.M as 2.50.
34	Pb1 See remark 1	Proportional band multiplier for cooling action	1.00 ... 5.00	Proportional band for cooling is given by the value of Pb (parameter 15) multiplied for the value of this parameter (default 1.00)
35	ATR121 oud ATR141 oudb See remark 1	In Heating/ Cooling PID this parameter defines the combinations of dead band for heating and cooling action	-20...50 % of Pb value	Negative value means dead band, positive value means overlapping (default 0)
36	Tc2 See remark 1	Cycle time for cooling output	1...300	Seconds (default 10)

37	FLW	Filter applied to visualization of process. This filter can slow down the refresh of value on display in order to simplify the reading.	OFF	Filter disabled (default)
			onF	Enable filter of first order (time const. 1s).
			5 2	Mean on 2 samples
			5 3	Mean on 3 samples
			5 4	Mean on 4 samples
			5 5	Mean on 5 samples
			5 6	Mean on 6 samples
			5 7	Mean on 7 samples
			5 8	Mean on 8 samples
			5 9	Mean on 9 samples
			5 10	Mean on 10 samples

14 - TUNING

Tuning operation allows the setting of optimal PID parameters in order to assure good control action:

- Stable, “straight-line” control of temperature around setpoint, without fluctuations;
- quick response to deviations from setpoint caused by external noises





Tuning involves calculating and setting of the following parameters:

- Proportional band (inertia of plant; expressed as °C for temperature)
- Integral time (determines the time taken by the controller to remove steady-state error signals, Inertia of plant expresses as time value);
- Derivative time (reaction of controller to change of measured value, usually $\frac{1}{4}$ of integral time)

Setpoint value cannot be modified during Autotuning.

15 - MANUAL START OF TUNING

Select parameter **EUn** as **MAN** (manual start)

	Press	Display	Do
1		Display shows toF	
2		Display shows ton	
3	 or wait for 4 seconds.	Display will show process value and EUn alternately until the function is completed (it may take a few minutes).	To interrupt the function press  and press  to select toF .

16 - AUTOTUNING

Parameter **EUn** must be selected as **Aut**. Autotuning starts automatically when the controller is switched-on or when setpoint value has been modified. Display alternates between process value and the writing **EUn** until the function has been completed (it may take a few minutes).

To interrupt the function, press  and press  to select **toF**.



17 - FUNCTION LATCH ON

For application with linear potentiometers P_{o1} (potentiometer $\leq 6K$) and P_{o2} (potentiometer $\leq 150K$) or 0...10Volt, 0/4...20mA inputs, the lower limit of scale (see parameter $L_{a n}$) can be set to minimum position of sensor; it is also possible to set the upper limit of scale (parameter $H_{i n}$) to the max. position of sensor and this can be done directly on site.







The option "virtual zero" (selecting W_{0n} or W_{0S}) allows also to fix the point where the controller will read zero (but still keeping the range of scale between $L_{a n}$ and $H_{i n}$).

Selecting W_{0S} virtual zero must be reprogrammed at each starting of the controller; selecting W_{0n} virtual zero will be stored after first calibration.

To enable function LATCH ON, select chosen configuration for parameter $L_{A E}^2$. For calibration function follow the table below.

	Press	Display	Do
1		Leave configuration mode. Display shows cycling process value and writing $L_{A E}$.	Set the sensor on minimum operating value (corresponding to $L_{a n}$)
2		Store minimum value. Display shows $L_{o U}$	Set the sensor on max. operating value (corresponding to $H_{i n}$)

² Calibration function exits configuration mode after that the relevant parameter has been modified.

3		Store max. value Display shows 	To quit standard proceeding press  . To enter "virtual zero" set the sensor to zero point.
4		Store virtual zero. Display shows  ** If  is selected, at starting repeat calibration on point 4.	To interrupt the function press  .

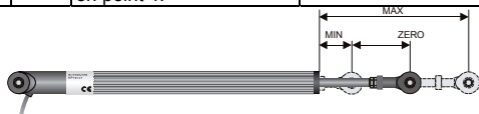

18 - FUNCTION NEUTRAL ZONE

The Neutral Zone function (which can be enabled selecting **FbN** on parameter 28 **FnC**) allows the setting of a neutral zone control action as described in the graph. In Heating mode (parameter **FEU** selected as **HEA**), the operating treshold for control relay will be the value resulting from SET1 minus SET2, and the operating treshold for alarm relay will be SET1 plus SET2 (hysteresis is always set via parameter **HYC**). Within this band both relays are off; one relay works above this band and one relay works below.

In Cooling mode (parameter **FEU** selected as **COO**) the operating tresholds of both relays are reversed.

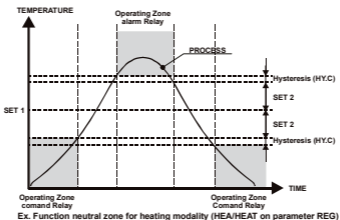

Standard alarm (band, deviation ...) is not available in this mode.

19 - SERIAL COMMUNICATION

Serial communication RS485 and protocol MODBUS – RTU enable the controller ATR121/141 to receive and exchange data, allowing the connection of more units to a centralized supervisory system. The device can be configured only as Slave unit.

LT (line termination) resistors on RS485 line must be removed to avoid anomalies.

Each controller will respond to a request only if it contains the same address which is written on parameter **Addr**. The range of admitted addresses is 1 – 254. Address 255 is used to communicate with all the connected units (Broadcast modality). Single units ATR121/141 on the same line cannot have the same address. Selecting 0 all connected units receive request but no answer is required. ATR121/141 may delay the answer to request. This delay (expressed as milliseconds) must be entered on parameter **dES**.

After each parameters change, the controller stores the new values on EEPROM memory (100000 writing). Modified sepoint values are stored on EEPROM memory with 10 seconds delay.

** Any operation on words which are not listed in the table below may cause anomalies or malfunction.

<i>Baud-rate</i>	Selectable by parameter bdr MD.1 = 300bit/s MD.2 = 9600bit/s MD.3 = 19200bit/s MD.4 = 38400bit/s
<i>Format</i>	8, N, 1 (8bit, no parity, 1 stop)
<i>Supported functions</i>	WORD READING (max 20 word) (0x03, 0x04) SINGLE WORD WRITING (0x06) MULTIPLE WORDS WRITING (0x10)

MODBUS ADDRESS	DESCRIPTION	READ/ WRITE	RESET VALUE
0	Type of device	R	101/102
1	Software version	R	?
2	Reserved	R	?
3	Reserved	R	?
4	Reserved	R	0
5	Slave Address	R	EEPR
6	Reserved	R	?
500	Loading default values (write 9999)	R/W	0
1000	Process value	R	0
1001	Cold junction value	R	0
1002	Value Setpoint 1	R/W	EEPR
1003	Value Setpoint 2	R/W	EEPR
1004	Heating output percentage (0-10000)	R	0
1005	Cooling output percentage (0-10000)	R	0
1006	Relay status (0=off, 1=on) Bit 0 = relay Q1 Bit 1 = relay Q2 Bit 2 = SSR	R/W	0
1007	Manual reset alarm. Write 1 to reset all alarms	R/W	0
1008	Error flags Bit0 = Eeprom writing error Bit1 = Eeprom reading error Bit2 = Cold junction error Bit3 = Process error (sensor) Bit4 = Generic error Bit5 = Missing calibration data error	R	0
1009	Start/Stop 0=controller in STOP	R/W	0

	1=controller in START		
1010	OFF LINE ¹ time (milliseconds)	R/W	0
2001	Parameter 1 <input type="text" value="cou"/> <input type="text" value="cout"/>	R/W	EEPR
2002	Parameter 2 <input type="text" value="SEn"/> <input type="text" value="SEn"/>	R/W	EEPR
2003	Parameter 3 <input type="text" value="dP."/> <input type="text" value="dP."/>	R/W	EEPR
2004	Parameter 4 <input type="text" value="LoS"/> <input type="text" value="Lo S"/>	R/W	EEPR
2005	Parameter 5 <input type="text" value="H.S"/> <input type="text" value="H. S"/>	R/W	EEPR
2006	Parameter 6 <input type="text" value="Lon"/> <input type="text" value="Lo n"/>	R/W	EEPR
2007	Parameter 7 <input type="text" value="H.n"/> <input type="text" value="H. n"/>	R/W	EEPR
2008	Parameter 8 <input type="text" value="LAtc"/> <input type="text" value="LAtc"/>	R/W	EEPR
2009	Parameter 9 <input type="text" value="cALo"/> <input type="text" value="cALo"/>	R/W	EEPR
2010	Parameter 10 <input type="text" value="cALG"/> <input type="text" value="cALG"/>	R/W	EEPR
2011	Parameter 11 <input type="text" value="rEG"/> <input type="text" value="rEG"/>	R/W	EEPR
2012	Parameter 12 <input type="text" value="ScC."/> <input type="text" value="ScC."/>	R/W	EEPR
2013	Parameter 13 <input type="text" value="LEd I"/> <input type="text" value="LEd I"/>	R/W	EEPR
2014	Parameter 14 <input type="text" value="HYc"/> <input type="text" value="HYSc"/>	R/W	EEPR
2015	Parameter 15 <input type="text" value="Pb"/> <input type="text" value="Pb"/>	R/W	EEPR
2016	Parameter 16 <input type="text" value="E.v"/> <input type="text" value="E.v"/>	R/W	EEPR
2017	Parameter 17 <input type="text" value="Ed"/> <input type="text" value="Ed"/>	R/W	EEPR
2018	Parameter 18 <input type="text" value="Ec."/> <input type="text" value="Ec."/>	R/W	EEPR

¹ If value is 0, the control is disabled. If different from 0, it is the max. time which can elapse between two pollings before the controller goes off-line.









If it goes off-line, the controller returns to Stop mode, the control output is disabled but the alarms are active

2019	Parameter 19	AL	AL	R/W	EEPR
2020	Parameter 20	crA	cr. A	R/W	EEPR
2021	Parameter 21	ScA	ScA	R/W	EEPR
2022	Parameter 22	Ld2	LEd2	R/W	EEPR
2023	Parameter 23	HYA	HYSA	R/W	EEPR
2024	Parameter 24	dEA	dELA	R/W	EEPR
2025	Parameter 25	PSE	PSE.	R/W	EEPR
2026	Parameter 26	FIL	FILT.	R/W	EEPR
2027	Parameter 27	tun	tunE	R/W	EEPR
2028	Parameter 28	Fnc	Func.	R/W	EEPR
2029	Parameter 29	GrA	GrAd.	R/W	EEPR
2030	Parameter 30	bdr	bdrE.	R/W	EEPR
2031	Parameter 31	Add	Addr.	R/W	EEPR
2032	Parameter 32	dES	dLSr.	R/W	EEPR
2033	Parameter 33	coF	cooF.	R/W	EEPR
2034	Parameter 34	PbN	PbN	R/W	EEPR
2035	Parameter 35	oud	oudb.	R/W	EEPR
2036	Parameter 36	tc2	tc. 2	R/W	EEPR
2037	Parameter 37	FLU	FLtu	R/W	EEPR

20 - MEMORY CARD (OPTIONAL)

Parameters and setpoint values can be easily copied from one controller to others using the MEMORY CARD. The controller must be switched-off before entering the Card. Check also entry direction (components must be turned towards front panel).

Switching-on the controller, display will show ³.

	Press	Display	Do
1	 	 shows   shows  .	Select  (Memo load) to store values of Memory on the controller. Select  to keep values of the controller unchanged.
2		The controller stores value and restarts.	

Updating values of memory card

To update values of Memory card follow the above proceedings, selecting  on display, so values of memory will not be stored on the controller⁴. Enter configuration mode, **modify at least one parameter** and exit.



³ Only if values stored on Memory Card are correct.

⁴ If the controller does not visualize  at starting, this

20.1 Memory C.243 with battery (OPTIONAL)



With the controller not connected to power supply.

The memory card is equipped with an internal battery with an autonomy of about 1000 uses.









Insert the memory card and press the programming buttons.

When writing the parameters, the led turns red and on completing the procedure it changes to green. It is possible to repeat the procedure without any particular attention.

means that no values are stored on Memory Card, but they may be copied and updated.

21 - LOADING DEFAULT VALUES

This procedure makes it possible to restore factory settings of the instrument.

	Premere	Effetto	Eeguire
1	 for 3 seconds.	After 5 seconds display shows  , first digit on the left is flashing.  on ATR141	
2	 or 	Change the flashing digit and move to the next one using the  key.	Enter password:  for ATR121  for ATR141
3	 to confirm	Instrument loads default settings and resets	

23 - CONFIGURATION MEMORANDUM

Date: _____ **Model** ATR121/141:
Installer: _____ **Plant:** _____
Notes: _____

Par.	Description	Default	Prom.
COU T	Select type of command output	0 102	
SE N	Sensor Type	Ec F	
DP	Visualization of decimal point	0	
Lo S	Lower limit of setpoint	0	
H S	Upper limit of setpoint	999	
	ATR121	1750	
	ATR141		
Lo n	Lower limit only for V/I V/mA	0	
H n	Upper limit only for V/I V/mA	999	
LAE C	Latch On Function	OFF	
eAL o	Offset calibration	00	
eAL G	Gain calibration	00	
F E C	Type of action	HEAT	
SC C	Type of contact for control output in case of anomaly	ca	
LE d I	Select state of OUT1	cc	
HYS c	Hysteresis dead/band	0	
P b	Proportional band	0	
E i	Integral time	0	
E d	Derivative time	0	
E c	Proportional cycle time	10	
AL	Type of alarm	ALA	
ca A	Contact alarm OUT	noS	

ScA	State of contact for alarm output in case of anomaly	co	
LEd2	State of the LED	cc	
HYSA	Alarms hysteresis	0	
dELA	delay alarm	0	
PSE	Set protection.	FrEE	
FILT	Software filter	10	
tunE	Type of autotuning	oFF	
Func	Type of operating	dSEt	
GrAd	Degrees selection	°C	
bdrE	Baud rate	7db3	
Addr	address slave	254	
dLSr	Serial delay	20	
cooF	Cooling fluid	Air	
PbN	Proportional band multiplier	100	
owdb	Overlapping / dead band	0	
tC_2	Cycle time 2	10	
FLtW	Visualization Filter	oFF	

26 - VISUALIZZATORI E TASTI

Visualizza normalmente il processo (es.: Temperatura sonda), ma può visualizzare anche il valore dei setpoint (punti d'intervento) oppure i dati in inserimento.

Visualizza il set, incrementa il set o scorre i parametri (con avanzamento veloce).

Visualizza il set, decrementa il set o scorre i parametri. (Con avanzamento veloce)

Visualizza i set-point (ex.:temperatura impostata), una pressione Set1(Led Out1 lampeggia) , seconda pressione Set2 (Led Out2 Lampeggia). In Configurazione se premuto contemporaneamente ad uno dei tasti freccia permette di modificare il valore del parametro visualizzato.



Quando lampeggiano stanno ad indicare il setpoint visualizzato sul display e quindi la possibilità di variarlo con i tasti freccia.

Quando accesi fissi indicano l'uscita attiva.









Si accende quando il regolatore risponde ad un'interrogazione da Seriale (versione con RS485).

Accesso alla programmazione dei parametri(sotto password).
Attiva le funzioni speciali



27 - CAMBIO DEL SETPOINT

Per modificare il valore impostato premere il tasto  una volta, o premere uno dei tasti freccia; il led OUT1 lampeggia, è quindi possibile impostare un nuovo valore con le frecce.

	Premere	Effetto	Eseguire
1	 oppure  oppure 	Il display visualizza il setpoint di comando e il Led OUT1 lampeggia.	Premere uno dei tasti  ,  per modificare il valore di setpoint (con avanzamento veloce). Dopo circa 4 secondi dall'ultima modifica il display torna a visualizzare il processo (ingresso sonda).
2		Il display visualizza il setpoint di allarme e il Led OUT2 lampeggia.	Premere  o  per aumentare o diminuire il valore di setpoint desiderato. Al rilascio dei tasti dopo circa 4 secondi il nuovo valore viene registrato automaticamente, il display torna a visualizzare il processo

28 - SEGNALAZIONE ANOMALIE

In caso di mal funzionamento dell'impianto, il regolatore attiva i relè, come da parametri 12 e 21 e segnala il tipo di anomalia riscontrata. Per esempio il regolatore segnalerà la rottura di una eventuale termocoppia collegata visualizzando E-5 (lampeggiante) sul display.

Per le segnalazioni vedere la tabella:

Errore	Causa	Cosa Fare
E-01	Errore in programmazione cella EPROM.	Contattare assistenza
E-02	Guasto sensore temperatura giunto freddo o temperatura ambiente al di fuori dei limiti ammessi.	Contattare assistenza
E-04	Dati di configurazione errati. Possibile perdita della tarature dello strumento.	Verificare che i parametri di configurazione siano corretti.
E-05	Termocoppia aperta o temperatura fuori limite.	Controllare il collegamento con le sonde e la loro integrità.
E-08	Taratura mancante	Contattare assistenza

Grazie per aver scelto un regolatore Pixsys.

Le versioni con display a tre e quattro digits permettono di impiegare lo strumento in una vasta gamma di applicazioni, ad esempio con sensori di temperatura, umidità, pressione, livello o potenziometri lineari. Le soluzioni di uscita prevedono sia il relè che la logica per SSR, è comunque configurabile il solo funzionamento come visualizzatore per gli impianti che non necessitano di uscite comando o di allarme. Con il PID e l'Autotune è semplice adattare all'impianto l'algoritmo di regolazione migliore, mentre nel caso di funzionamento con potenziometri lineari la funzione LATCH ON velocizza la taratura della macchina.

Come sulla più recente strumentazione Pixsys sono disponibili Memory-card per la configurazione in serie e per lo storico degli impianti. Seguendo le tabelle sottostante si può facilmente identificare il modello desiderato.

31 - COMPOSIZIONE DELLA SIGLA

Composizione della sigla Modello ATR121

ATR121-	xx	x	
<i>Alimentazione</i>	AD		12...24Vac \pm 10% 50/60Hz 12...35Vdc
	A		24 Vac \pm 10% 50/60 Hz
	B		230 Vac \pm 10% 50/60 Hz
	C		115 Vac \pm 10% 50/60 Hz
<i>Seriale</i>	A	T	Rs485 con protocollo Modbus RTU slave.
	AD	T	In queste versioni non è disponibile il Relè Q2 e la funzione allarme è disponibile su uscita SSR. Solo versione AT: 24Vac \pm 10% 50/60 Hz Solo versione ADT: 12...35Vdc

Composizione della sigla Modello ATR141

ATR141-	xx	x	
<i>Alimentazione</i>	AD		12...24Vac \pm 10% 50/60Hz 12...35Vdc
	A		24 Vac \pm 10% 50/60 Hz
	B		230 Vac \pm 10% 50/60 Hz
	C		115 Vac \pm 10% 50/60 Hz
<i>Seriale</i>	A	T	Rs485 con protocollo Modbus RTU slave.
	AD	T	In queste versioni non è disponibile il Relè Q2 e la funzione allarme è disponibile su uscita SSR. Solo versione AT: 24Vac \pm 10% 50/60 Hz Solo versione ADT: 12...35Vdc

Caratteristiche generali

<i>Display</i>	3 display (0,56 pollici) su ATR121 4 display (0,40 pollici) su ATR141 + 3 led (Out1 , Out2 , Fnc)
<i>Temperatura di esercizio</i>	0-40°C - umidità 35..95uR%
<i>Protezione</i>	Pannello frontale IP65 (con guarnizione) / Contenitore IP30 / Morsettiere IP20
<i>Materiale</i>	Policarbonato UL94V0 autoestinguente
<i>Peso</i>	ca. 100 g.

Caratteristiche hardware

<i>Ingressi analogici</i>	AN1 Configurabile via software Termocoppie: Tipo K, S, R, J. Termoresistenze: PT100, PT500, PT1000, NI100, PTC 1K, NTC 10K (β 3435K) Ingresso V/I: 0-10V ($R_i \geq 110 \text{ K}\Omega$) 0-20, 4-20mA ($R_i \leq 4,7 \Omega$) Potenzimetri: 6K Ω , 150K Ω	Tolleranze a 25°C 0.5 % \pm 1 digit x termocoppie e termoresistenze Giunto freddo 0.2°C/°C di temperatura ambiente 0.2% \pm 1 digit per V/I
<i>Uscite relè</i>	2 Relè': OUT1: 10A carico resistivo su versione AD , 8A carico resistivo su versioni con trasformatore. OUT2: 5A carico resistivo.	
<i>Uscita SSR</i>	8 Volt 20mA per versioni A/B/C. 15Volt 30mA per versioni AD(alim. 12Vac) 30Volt 30mA per versioni AD(alim. 24Vac)	

Caratteristiche software

Algoritmo di regolazione	On/OFF con isteresi o P.I.D. con Autotune
Protezione dati	Parametri sotto password programmazione veloce da memory-card

32.1 Dimensioni e installazione

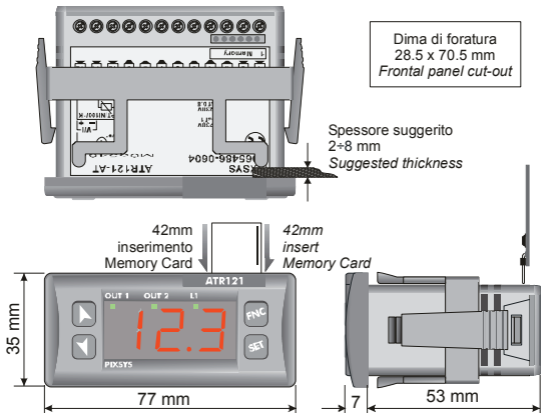

33 - COLLEGAMENTI ELETTRICI



Benché questo regolatore sia stato progettato per resistere ai più gravosi disturbi presenti in ambienti industriali, è buona norma seguire le seguenti precauzioni: Distinguere la linea d'alimentazione da quelle di potenza. Evitare la vicinanza di gruppi di teleruttori, contattori elettromagnetici, motori di grossa potenza.

Evitare la vicinanza di gruppi di potenza, in particolare se a controllo di fase.

34 - SCHEMA DI COLLEGAMENTO ATR121 / ATR141

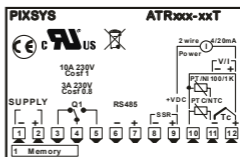
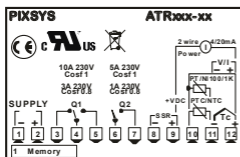

34.1 Alimentazione in bassa tensione 12/24 Vac-dc Modelli: ATR121-AD e ATR141-AD



12...24Vac $\pm 10\%$ 50Hz/60Hz

12...35Vdc

N.B.: per versione "T" con seriale solo
12...35Vdc

34.2 Alimentazione da rete a 24/115/230 Vac

Modelli: ATR121-AB o C e ATR141-AB o C



24Vac $\pm 10\%$ 50/60Hz

230Vac $\pm 10\%$ 50/60Hz

115Vac $\pm 10\%$ 50/60Hz

34.3 AN1 Ingresso analogico

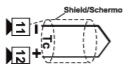

Per termocoppia K, S, R, J;

- Rispettare le polarità
- Per eventuali prolunghe utilizzare cavo e morsetti compensati adatti alla termocoppia utilizzata.

⚠ (solo per modelli AD)

Per un corretto funzionamento dello strumento, utilizzare sonde isolate da terra. In caso contrario, utilizzare singolo trasformatore isolato per ogni strumento.

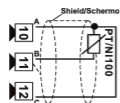

Per termoresistenza Pt100, NI100:

- Per il collegamento a tre fili usare cavi della stessa sezione.
- Per Pt100 a due fili cortocircuitare morsetti 10 e 12.



Normalmente, su Pt100, A e C sono dello stesso colore.

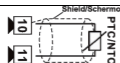

Per termoresistenza NTC, PTC, PT500, PT1000 e potenziometri.

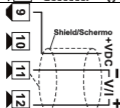

Per ingressi normalizzati V/I

- Rispettare le polarità

34.4 Esempi di connessione per ingressi normalizzati

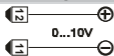

Per segnali normalizzati in tensione
0...10V
Rispettare le polarità
 $R_i \geq 110K\Omega$

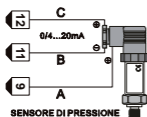

Per segnali normalizzati in corrente 0 ÷ 20mA oppure
4 ÷ 20mA con sensori a tre fili. Rispettare le polarità
A= alimentazione sensore

 Verificare la compatibilità dell'alimentazione sulla documentazione del sensore.

Portata 12...24V / 30mA su versioni AD

Portata 8V / 20mA su versioni A-B-C

B= massa sensore

C= uscita sensore

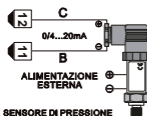

Per segnali normalizzati in corrente
0 ÷ 20mA oppure 4 ÷ 20mA
con sensori ad alimentazione esterna
Rispettare le polarità
B= massa sensore
C= uscita sensore

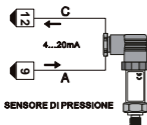

Per segnali normalizzati in corrente
4 ÷ 20mA con sensori a due fili.
Rispettare le polarità

A= alimentazione sensore

 Verificare la compatibilità dell'alimentazione sulla documentazione del sensore.

Portata 12...24V / 30mA su versioni AD

Portata 8V / 20mA su versioni A-B-C

C= uscita sensore

34.5 Uscite a relè

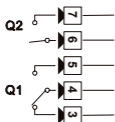

- Q1 con contatti : 8A/250V~ (**Su versioni A-B-C**) per carichi resistivi (manovre 2×10^5 min a 8A /250V~)
- Q1 con contatti : 10A/250V~ (**Su versioni AD**) per carichi resistivi (manovre 2×10^5 min a 10A /250V~)
- Q2 con contatti : 5A/250V~ per carichi resistivi (manovre 2×10^5 min a 3A /250V~)

34.6 Uscita SSR



Portata 12...30V/30mA su versioni AD
Portata 8V/20mA su versioni A-B-C
Uscita comando con configurazione relè stato solido (SSR)

34.7 Comunicazione seriale

Modelli: ATR121-xT e ATR141-xT

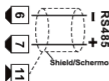

Comunicazione compatibile RS485 con protocollo MODBUS-RTU

⚠ Non usare resistenza terminazione BUS su entrambi i capi.

35.1 Allarme assoluto o allarme di soglia (selezione

ALA)

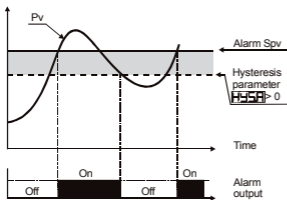

Allarme assoluto con regolatore in funzionamento caldo.

Par.11 **FEG** selezionato
HEAT e isteresi (valore assoluto)

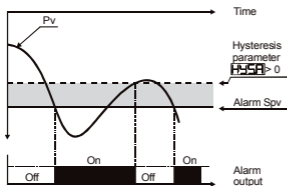

Allarme assoluto con regolatore in funzionamento freddo.

Par.11 **FEG** selezionato
COOL e isteresi (valore assoluto)

35.2 Allarme assoluto o allarme di soglia riferito al setpoint di comando (selezione **ALAS**)

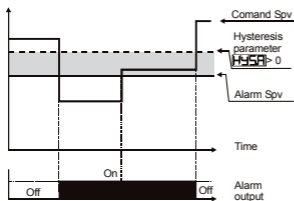

Allarme assoluto riferito al set di comando, con regolatore in funzionamento caldo.

Par.11 **REC** selezionato **HEAL** e isteresi (valore assoluto)

Il set di comando può essere variato con la pressione dei tasti freccia da frontale o con comandi su porta seriale RS485.

35.3 Allarme di Banda (selezione **ALB**)

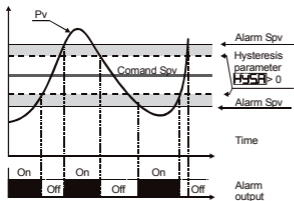

Allarme di banda con isteresi

N.B.: il valore dell'isteresi non può essere minore di 0.

35.4 Allarme deviazione superiore (selezione **ALDS**)

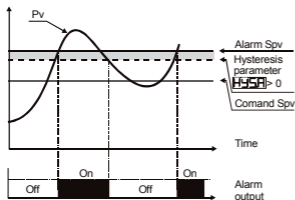

Allarme di deviazione superiore valore di setpoint allarme maggiore di "0" e valore di isteresi maggiore di "0" (Par.23 **HYSA** > 0).
 N.B.: il valore dell'isteresi non può essere minore di 0.

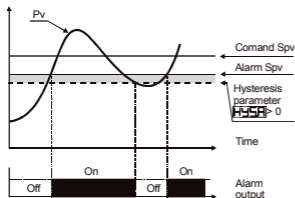

Allarme di deviazione superiore valore di setpoint allarme minore di "0" e valore di isteresi maggiore di "0" (Par.23 **HYSA** > 0).
 N.B.: il valore dell'isteresi non può essere minore di 0.

35.5 Allarme deviazione inferiore (selezione **Ald 1**)

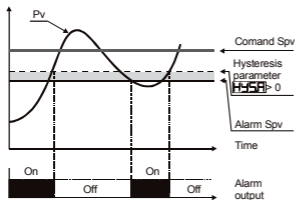



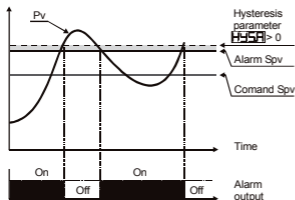



Allarme di deviazione inferiore valore di setpoint allarme maggiore di "0" e valore di isteresi maggiore di "0" (Par.23 **HYSA** > 0).
N.B.: il valore dell'isteresi non può essere minore di 0.



Allarme di deviazione inferiore valore di setpoint allarme minore di "0" e valore di isteresi maggiore di "0" (Par.23 **HYSA** > 0).
N.B.: il valore dell'isteresi non può essere minore di 0.

36 - MODIFICA PARAMETRI DI CONFIGURAZIONE

La configurazione dello strumento è prevista sotto password in quanto di responsabilità del gestore dell' impianto. Tale password ha la funzione di preservare i parametri di configurazioni da operazioni indesiderate da parte dell'operatore e non è modificabile.







	Premere	Effetto	Eseguire
1		Il display dopo circa 5 secondi visualizza 000 con la prima cifra da sinistra lampeggiante. 0000 Nel caso del ATR141	
2		Incrementare la prima cifra al valore "1".	Premere  per passare alla cifra successiva ed inserire la password di configurazione "123" o "1234" per ATR141
3		Il display visualizza il primo parametro della tabella di configurazione. COU per ATR121 COU per ATR141	
4	 	Con i tasti freccia è possibile scorrere in avanti e indietro tutta la tabella di configurazione.	Scegliere il parametro che si desidera variare, premere il tasto  per visualizzarlo, e i tasti freccia per configurarlo.

37 - TABELLA PARAMETRI DI CONFIGURAZIONE

N	Display	Descrizione Parametri	Range di inserimento		
			ATR12 1	ATR141	Descrizione
1	ATR121 COU	Selezione tipo uscita di comando	012	0102	<ul style="list-style-type: none"> Comando Q1 Allarme Q2 (Default)
	ATR141 COU2		015	0155	<ul style="list-style-type: none"> Comando Q1 Allarme SSR
			55r	55r	<ul style="list-style-type: none"> Comando SSR Allarme Q1
			02.1	0201	<ul style="list-style-type: none"> Comando Q2 Allarme Q1
			5Er	5Erw	<ul style="list-style-type: none"> Apri Q1 Chiudi Q2 (SSR se vers. seriale)
2	5Er	Definisce il tipo di sensore collegato. ATTENZIONE (solo per modelli -AD) Per un corretto funzionamento dello strumento, utilizzare sonde isolate da terra. In caso	EcT	Ec. T	Termocoppia K -260...1360 °C (Default)
			EcS	Ec. S	Termocoppia S -40...1760 °C
			EcR	Ec. r	Termocoppia R -40...1760 °C
			EcJ	Ec. J	Termocoppia J -200...1760°C
			Pt	Pt	Pt100 - 200..600°C
			Pt1	Pt1	Pt100 - 200..140°C
			Ni	Ni	Ni100 - 60..180°C

		contrario, utilizzare singolo trasformatore isolato per ogni strumento.			Ntc 10K Ω - 40...125 °C
					Ptc 1K Ω - 50...150 °C
					Pt500 - 100...600 °C
					Pt1000 - 100...600 °C
					0...10V
					0...20mA
					4...20mA
					Potenzimetro \leq 6K Ω fondo scala
					Potenzimetro \leq 150K Ω fondo scala
3		Seleziona il tipo di decimale visualizzato			No decimale (Default)
					Un decimale
					Due decimali
					Tre decimali
4		Limite inferiore impostabile per il setpoint	-199... +999	-999... +9999	Valore in gradi per sensori di temperatura e digit per sensori normalizzati e potenziometri. (Default 0)

5	H.L.S	Limite superiore impostabile per il setpoint	-199... +999	-999... +9999	Valore in gradi per sensori di temperatura e digit per sensori normalizzati e potenziometri. (Default: 999 per ATR121 e 1750 per ATR141)
6	L.a.n	Limite inferiore range solo per normalizzati Esempio: con ingresso 4..20mA questo parametro assume il valore associato a 4mA	-199... +999	-999... +9999	Valore in digit (Default 0)
7	H.L.n	Limite superiore range solo per normalizzati Esempio: con ingresso 4..20mA questo parametro assume il valore associato a 20mA	-199... +999	-999... +9999	Valore in digit (Default 999)
8	ATR121 L.A.E	Funzione Latch On (Impostazione	oFF		Disabilitata (Default)
			Std		Standard







	ATR141 LAtc	automatica limiti per potenziometri lineari e ingressi normalizzati)	 		Zero virtuale memorizzato Zero virtuale start
9	ATR121  ATR141 	Definisce la correzione offset sulla visualizzazione dell'ingresso sensore. (Numero che si somma/ sottrae al valore di processo visualizzato; normalmente usato per correggere il valore di temp.ambiente)	-19.9... +99.9	-99.9... +99.9	Valore in decimi di grado per sensori di temperatura e digit per sensori normalizzati e potenziometri. (Default 0.0)
10	ATR121  ATR141 	Definisce la calibrazione del guadagno sull'ingresso sensore (valore che moltiplica il numero visualizzato per eseguire calibrazioni sul punto di lavoro del processo)	-19.9% +99.9%	-99.9% +99.9%	Percentuale (Default 0.0)

11	rEG	Tipo regolazione	HEA	HEAE	Caldo (N.A.) (Default)
			COO	COOL	Freddo (N.C.)
			AL.	AL.	Allarme assoluto con riarmo manuale
			ALN	ALN	Allarme assoluto con riarmo manuale e memoria stato relè in caso di spegnimento
			HOO	HOO	Caldo con PID sempre a 0 se il processo è sopra il set.
12	Scc	Stato del contatto di uscita comando in caso di guasto	ca.		Sicurezza a contatto aperto. (Default)
			cc.		Sicurezza a contatto chiuso.
13	ATR121 Ld I	Definisce lo stato del led OUT1 in corrispondenza del relativo contatto	ca.		Acceso a contatto aperto.
	ATR141 LEd I		cc.		Acceso a contatto chiuso. (Default)













14	ATR121 H4c ATR141 H45c	Isteresi in ON/OFF o banda morta in P.I.D. dell'uscita di comando	-199... +999	-999... +999	Valore in decimi di gradi per sensori di temperatura e digit per sensori normalizzati e potenziometri. (Default 0.0)
15	Pb	Banda proporzionale Inerzia del processo in unità (Esempio: se temperatura in °C)	0...999	0...9999	0 = On/Off Valore in gradi per sensori di temperatura e digit per sensori normalizzati e potenziometri. (Default 0)
16	Ti	Tempo integrale. Inerzia del processo in secondi	0-999	0-9999	Secondi. (0 integrale disabilitato). (Default 0)
17	Td	Definisce il tempo derivativo dell'azione P.I.D. Normalmente ¼ del tempo integrale	0...999	0...9999	Secondi. (0 derivativo disabilitato). (Default 0)

18	E.C.	Definisce la durata del ciclo per l'uscita a tempo proporzionale (per contattori normalmente superiore a 10, per SSR normalmente a 1, per valvole motorizzate valore dichiarato da produttore)	1-300		Secondi. Impostando 0 il tempo di ciclo diventa 100ms (Default 10)
19	AL	Modalità di allarme. L'intervento dell'allarme è associato al SET2.	A A	AL A	Assoluto riferito al processo (allarme di soglia) (Default)
			A b	AL b	Banda
			Ad S	AL d S	Deviazione superiore
			Ad I	AL d I	Deviazione inferiore
			AAS	AL AS	Assoluto riferito al setpoint 1
			COO	COOL	Uscita comando raffreddamento in modalità Caldo/freddo ¹

¹ I parametri 33,34,35,36 vengono considerati solo in doppia azione caldo/freddo (AL impostato su COO) e con Pb diverso da 0.

					Assoluto con riarmo manuale. Dopo l'attivazione dell'allarme l'uscita viene sbloccata premendo il tasto FNC sul frontale
					Assoluto con riarmo manuale e memoria stato relè in caso di spegnimento. Dopo l'attivazione dell'allarme l'uscita viene sbloccata premendo il tasto FNC sul frontale
20		Contatto uscita allarme e tipo intervento			Normalmente aperto attivo allo start. (Default)
					Normalmente chiuso attivo allo start.
					Normalmente aperto attivo al raggiungimento dell'allarme ⁵ .

⁵ All'accensione, l'uscita è inibita se lo strumento è in condizione di allarme. Si attiva solo quando rientrato dalla



					Normalmente chiuso attivo al raggiungimento dell'allarme ⁵ .
21		Stato del contatto dell'uscita di allarme in caso di guasto			Sicurezza a contatto aperto. (Default)
					Sicurezza a contatto chiuso.
22	ATR121 	Definisce lo stato del led OUT2 in corrispondenza del relativo contatto			Acceso a contatto aperto.
	ATR141 				Acceso a contatto chiuso. (Default)
23	ATR121 	Isteresi allarmi	-199... +999	-999... +9999	Valore in decimi di gradi per sensori di temperatura e digit per sensori normalizzati e potenziometri. (Default 0.0)
	ATR141 				
24	ATR121 	Ritardo allarme	-180...+180		Secondi. Negativo: ritardo all'uscita dallo stato di allarme. Positivo: ritardo all'entrata dello stato di allarme. (Default 0)
	ATR141 				

condizione d'allarme, questa si ripresenta.

25	PSE	Protezione set. Consente o inibisce la modifica dei setpoint da tastiera	FrE	FrEE	Entrambi i set modificabili. (Default)
			PrS	ProS	Protezione set di comando SPV1
			PrA	PrOa	Protezione set di allarme SPV2
			ALL	ALL	Protezione di entrambi i set.
26	ATR121 FIL ATR141 FILT	Filtro software. Numero di letture per il calcolo della media che definisce il valore di confronto PV-SPV	1-15		Numero di medie. Campionamento a 15Hz. (Default 10)
27	ATR121 tun ATR141 tunE	Selezione tipo auto-tuning	oFF	oFF	Disabilitato. (Default)
			Aut	Auto	Automatico.
			MAN	MAN	Lancio manuale.
28	ATR121 Func ATR141 Func	Selezione funzionamento e opzioni di visualizzazione	dSE	dSEt	Doppio setpoint. (Default)
			sSE	sSEt	Singolo setpoint.
			u iS	u iS	Visualizzatore
			FbN	FbN	Funzione banda morta
			NA i	NA in	Funzione maschera processo e setpoint.

					Demotica 1 : spegne il display e i led dopo 15" dall'ultima azione sui tasti
					Demotica 2 : spegne solo il display dopo 15" dall'ultima azione sui tasti.
					Demotica 3 : spegne il display (ma non il punto decimale) dopo 15" dall'ultima azione sui tasti.
					Singolo setpoint: il setpoint resta sempre visualizzato. Per vedere il processo premere il tasto : il processo lampeggia
29	ATR121 	Selezione tipo gradi			Gradi centigradi (Default)
	ATR141 				Gradi Fahrenheit
30	ATR121 	Baud rate della comunicazione seriale			300 bit/s
					9600 bit/s
					19200 bit/s (Default)
	ATR141 				38400 bit/s

31	ATR121 Add ATR141 Addr.	Indirizzi slave	1-254	(Default 254)
32	ATR121 dES ATR141 dLSr.	Ritardo seriale	0-100	Millisecondi (Default 20)
33	Atr121 coF Atr141 cooF. Vedi nota 1	In modalità PID Caldo/freddo definisce il fluido di raffreddamento: modificando questo parametro PbN e tcc2 assumono i valori riportati a lato.	Air Aria	Imposta TC2 a 10s e P.B.M a 1.00. (Default)
			oil Olio	Imposta TC2 a 4s e P.B.M a 1.25.
			H2o Acqua	Imposta TC2 a 2s e P.B.M a 2.50.
34	PbN Vedi nota 1	Moltiplicatore di banda proporzionale per il raffreddamento.	1.00 ... 5.00	La banda proporzionale per il freddo è il valore di Pb (parametro 15) moltiplicato per questo valore. (Default 1.00)
35	Atr121 oud Atr141 oudb. Vedi nota 1	In modalità PID Caldo/freddo definisce le combinazioni di banda morta per l'azione di riscaldamento e raffreddamento	-20...50 % del valore di Pb	Negativo indica banda morta, positivo significa sovrapposizione. (Default 0)

36	 Vedi nota 1	Tempo ciclo per l'uscita di raffreddamento.	1...300	Secondi (Default 10)
37		Filtro in visualizzazione del processo. Rallenta il refresh del valore di processo visualizzato per facilitarne la lettura	OFF	Filtro disabilitato. (Default)
			ONF	Abilitato filtro del primo ordine (cost. di tempo 1s).
			5 2	Media su 2 campioni.
			5 3	Media su 3 campioni.
			5 4	Media su 4 campioni.
			5 5	Media su 5 campioni.
			5 6	Media su 6 campioni.
			5 7	Media su 7 campioni.
			5 8	Media su 8 campioni.
			5 9	Media su 9 campioni.
			5 10	Media su 10 campioni

L'operazione di tuning consente di calcolare i parametri PID al fine di ottenere una buona regolazione. Ciò significa controllo stabile della temperatura/processo sul setpoint senza fluttuazioni e risposta veloce alle deviazioni dal setpoint causate da disturbi esterni.





L'operazione di tuning prevede il calcolo ed il settaggio dei seguenti parametri:

- Banda proporzionale (inerzia del sistema in °C con temperature).
- Tempo integrale (il tempo impiegato dal regolatore per rimuovere segnalazioni di errore fisse , corrisponde all'inerzia del sistema in tempo).
- Tempo derivativo (determina l'intensità della reazione del regolatore alla variazione del valore misurato, normalmente $\frac{1}{4}$ del tempo integrale).

Durante il calcolo dell'autotune non è possibile cambiare il setpoint.

39 - LANCIO DEL TUNING MANUALE

Il parametro **tun** impostato su **MAN**.

	Premere	Effetto	Eeguire
1		Il display visualizza toF	
2		Il display visualizza ton	
3	 o attendere 4 secondi.	Il display visualizza alternativamente il processo e la scritta tun fino al completamento della procedura (può durare qualche minuto).	Per terminare anticipatamente la procedura, premere  e il tasto  per selezionare toF .

40 - TECNICA DI TUNING AUTOMATICO

Il tuning automatico (parametro **Eun** impostato su **AUT**) si attiva all'accensione dello strumento o quando viene modificato sensibilmente il setpoint.

Il display visualizza alternativamente il processo e la scritta **Eun** fino al completamento della procedura (può durare qualche minuto).

Per terminare anticipatamente la procedura, premere **ANC** e il tasto  per selezionare **EOF**.

41 - FUNZIONE LATCH ON

Per l'impiego con ingresso **Po1** (potenziometro $\leq 6K$) e **Po2** (potenziometro $\leq 150K$) e con ingressi normalizzati (0...10Volt, 0/4...20mA), è possibile associare il valore di inizio scala (parametro **La n**) alla posizione di minimo del sensore e quello di fine scala (parametro **H n**) alla posizione di massimo del sensore, direttamente sull'impianto.







E' inoltre possibile fissare il punto in cui lo strumento visualizzerà 0 (mantenendo comunque il campo scala compreso tra **La n** e **H n**) tramite l'opzione di "zero virtuale" impostando **W0n** oppure **W0S**.

Se si imposta **W0S** lo zero virtuale andrà riprogrammato dopo ogni accensione dello strumento; se si imposta **W0n** lo zero virtuale resterà fisso una volta tarato.

Per utilizzare la funzione LATCH ON configurare come desiderato il parametro **LAE**.⁶

⁶ La procedura di taratura parte uscendo dalla configurazione dopo aver variato il parametro.

Per la procedura di taratura fare riferimento alla seguente tabella:

	Premere	Effetto	Eeguire
1		Esce dalla configurazione parametri. Lo strumento visualizza alternativamente il processo e la scritta LAE .	Posizionare il sensore sul valore minimo di funzionamento (associato a Lo n)
2		Fissa il valore sul minimo. Il display visualizza LoU	Posizionare il sensore sul valore massimo di funzionamento (associato a Hu n)
3		Fissa il valore sul massimo. Il display visualizza HuG	Per uscire dalla procedura standard premere  . Nel caso di impostazione con "zero virtuale" posizionare il sensore nel punto di zero.
4		Fissa il valore di zero virtuale. Il display visualizza Uir N.B.: nel caso di selezione UOS all'accensione va rieseguita la procedura al punto 4.	Per uscire dalla procedura premere  .



42 - FUNZIONE BANDA MORTA

La funzione Banda Morta (abilitata impostando **FbN** nel parametro 28 **FnO**) permette di eseguire una regolazione detta appunto di “banda morta” (vedi figura). In funzionamento caldo (parametro **REG** impostato su **HEA**), la soglia di intervento del relè di comando sarà data da SET1-SET2 (con isteresi impostata sul parametro **HYC**), mentre la soglia di intervento del relè di allarme sarà SET1+SET2 (l'isteresi è sempre **HYC**). In sostanza si viene a creare una banda all'interno della quale i relè sono entrambi aperti; i relè, invece, intervengono uno sopra e l'altro sotto la banda. In funzionamento freddo (parametro **REG** impostato su **COO**) si invertono le soglie di intervento dei due relè.

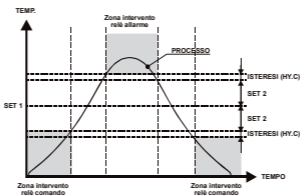

Es. Funzione Banda morta in modalità caldo (HEA/HEAT su Parametro REG)

In questa modalità l'uso dell'allarme nel modo tradizionale (banda, deviazione, ecc..) viene inibito.

L'ATR121/141 con RS485 è in grado di ricevere e trasmettere dati via seriale tramite protocollo MODBUS RTU. Il dispositivo può essere configurato solo come Slave. Questa funzione permette il controllo di più unità ATR121/141 collegandole ad un sistema di supervisione. La linea RS485 deve essere priva delle resistenze di terminazione LT per evitare mal funzionamenti.

Ogni strumento risponderà ad un'interrogazione del Master solo se questa contiene l'indirizzo uguale a quello contenuto nel parametro

Add. Gli indirizzi permessi vanno da 1 a 254, non devono esserci più ATR121/141 con lo stesso indirizzo sulla stessa linea.

L'indirizzo 255 viene usato per comunicare con tutte le apparecchiature collegate (modalità broadcast); selezionando 0 tutti i dispositivi ricevono il comando ma non è prevista la risposta.

L'ATR121/141 può introdurre un ritardo (in millisecondi) della risposta alla richiesta del Master; tale ritardo deve essere

impostato sul parametro **dES**

Ad ogni variazione dei parametri lo strumento salva il valore in memoria EEPROM (100000 cicli di scrittura). Il salvataggio in memoria EEPROM del setpoint avviene con un ritardo di 10 secondi dalla modifica.

NB: Modifiche apportate a Word diverse da quelle riportate nella tabella seguente possono causare mal funzionamenti dello strumento.

<i>Baud-rate</i>	Selezionabile da parametro bdr	
	MD.1 = 300bit/s	
	MD.2 = 9600bit/s	
	MD.3 = 19200bit/s	
	MD.4 = 38400bit/s	
<i>Formato</i>	8, N, 1 (8bit, no parità, 1 stop)	
<i>Funzioni supportate</i>	WORD READING (max 20 word)	(0x03, 0x04)
	SINGLE WORD WRITING	(0x06)
	MULTIPLE WORDS WRITING	(0x10)
	(max 20 word)	

MODBUS ADDRESS	DESCRIZIONE	READ/ WRITE	RESET VALUE
0	Tipo dispositivo	R	101/102
1	Versione software	R	?
2	Riservato	R	?
3	Riservato	R	?
4	Riservato	R	0
5	Address Slave	R	EEPR
6	Riservato	R	?
500	Caricamento valori di default (scrivere 9999)	R/W	0
1000	Valore processo	R	0
1001	Valore giunto freddo	R	0
1002	Valore Setpoint 1	R/W	EEPR
1003	Valore Setpoint 2	R/W	EEPR
1004	Percentuale uscita caldo (0-10000)	R	0
1005	Percentuale uscita freddo (0-10000)	R	0
1006	Stato relè (0=off, 1=on) Bit 0 = relè Q1 Bit 1 = relè Q2 Bit 2 = SSR	R/W	0
1007	Riarmo manuale allarmi. Scrivere 1 per riarmare tutti gli allarmi	R/W	0
1008	Flags errori Bit0 = errore scrittura eeprom Bit1 = errore lettura eeprom Bit2 = Errore giunto freddo Bit3 = Errore processo (sensore) Bit4 = Error generico Bit5 = Dati di taratura mancanti	R	0
1009	Start/Stop 0=regolatore in STOP	R/W	0

	1=regolatore in START		
1010	Tempo OFF LINE ¹ (millisecondi)	R/W	0
2001	Parametro 1 <input type="text" value="cov"/> <input type="text" value="cout"/>	R/W	EEPR
2002	Parametro 2 <input type="text" value="SEn"/> <input type="text" value="SEn"/>	R/W	EEPR
2003	Parametro 3 <input type="text" value="dP."/> <input type="text" value="dP."/>	R/W	EEPR
2004	Parametro 4 <input type="text" value="LoS"/> <input type="text" value="Lo S"/>	R/W	EEPR
2005	Parametro 5 <input type="text" value="H.S"/> <input type="text" value="H. S"/>	R/W	EEPR
2006	Parametro 6 <input type="text" value="Lon"/> <input type="text" value="Lo n"/>	R/W	EEPR
2007	Parametro 7 <input type="text" value="H n"/> <input type="text" value="H. n"/>	R/W	EEPR
2008	Parametro 8 <input type="text" value="LAt"/> <input type="text" value="LAtc"/>	R/W	EEPR
2009	Parametro 9 <input type="text" value="cALo"/> <input type="text" value="cALo"/>	R/W	EEPR
2010	Parametro 10 <input type="text" value="cALG"/> <input type="text" value="cALG"/>	R/W	EEPR
2011	Parametro 11 <input type="text" value="rEG"/> <input type="text" value="rEG"/>	R/W	EEPR
2012	Parametro 12 <input type="text" value="ScC"/> <input type="text" value="ScC."/>	R/W	EEPR
2013	Parametro 13 <input type="text" value="LEd I"/> <input type="text" value="LEd I"/>	R/W	EEPR
2014	Parametro 14 <input type="text" value="HYc"/> <input type="text" value="HYSc"/>	R/W	EEPR
2015	Parametro 15 <input type="text" value="Pb."/> <input type="text" value="Pb."/>	R/W	EEPR
2016	Parametro 16 <input type="text" value="E."/> <input type="text" value="E."/>	R/W	EEPR
2017	Parametro 17 <input type="text" value="Ed."/> <input type="text" value="Ed."/>	R/W	EEPR
2018	Parametro 18 <input type="text" value="Ec."/> <input type="text" value="Ec."/>	R/W	EEPR









¹ Se vale 0 il controllo è disabilitato. Se diverso da 0, è "Il tempo massimo che può trascorrere tra due interrogazioni senza che il regolatore si porti in Off-Line". In Off-Line il regolatore va in stato di Stop, disabilita l'uscita di comando, ma mantiene gli allarmi attivi.

2019	Parametro 19	AL	AL	R/W	EEPR
2020	Parametro 20	crA	cr. A	R/W	EEPR
2021	Parametro 21	ScA	ScA	R/W	EEPR
2022	Parametro 22	Ld2	LEd2	R/W	EEPR
2023	Parametro 23	HYA	HYSA	R/W	EEPR
2024	Parametro 24	dEA	dELA	R/W	EEPR
2025	Parametro 25	PSE	PSE	R/W	EEPR
2026	Parametro 26	FIL	FILt	R/W	EEPR
2027	Parametro 27	tun	tunE	R/W	EEPR
2028	Parametro 28	Fnc	Func	R/W	EEPR
2029	Parametro 29	GrA	GrAd	R/W	EEPR
2030	Parametro 30	bdr	bdrE	R/W	EEPR
2031	Parametro 31	Add	Addr.	R/W	EEPR
2032	Parametro 32	dES	dLSr	R/W	EEPR
2033	Parametro 33	coF	cooF	R/W	EEPR
2034	Parametro 34	PbN	PbN	R/W	EEPR
2035	Parametro 35	oud	oudb	R/W	EEPR
2036	Parametro 36	ecc2	ec. 2	R/W	EEPR
2037	Parametro 37	FLW	FLtW	R/W	EEPR

44 - MEMORY CARD (OPZIONALE)

E' possibile duplicare parametri e setpoint da un regolatore ad un altro mediante l'uso della Memory Card. Inserire la Memory Card **con regolatore spento** facendo **attenzione al verso di inserimento** (componenti verso il frontale).

Accendendo il regolatore il display visualizza ⁷.

	Preme re	Effetto	Eeguire
1	 	 visualizza  ,  visualizza  .	Selezionare  (memo load) se si desidera caricare i valori contenuti nella MemoryCard all'interno del regolatore. Selezionando  i valori del regolatore rimarranno invariati.
2		Il regolatore carica i valori e riparte.	

Aggiornamento dei valori della Memory Card.

Per *aggiornare* i valori della Memory Card, seguire il procedimento appena descritto impostando  sul display in modo da non caricare i valori della Memory Card sul regolatore⁸. Entrare in configurazione, **variare almeno uno dei parametri** e uscire.



⁷ Solo se nella Memory Card sono salvati valori corretti.

⁸ Nel caso in cui all'accensione il regolatore non visualizzi

44.1 Memory C.243 con batteria (OPZIONALE)



Con regolatore non connesso all'alimentazione:









La memory card è dotata di batteria interna con autonomia per circa 1000 utilizzi.

Inserire la memory card e premere il tasto di programmazione. Durante la scrittura dei parametri il led si accende rosso, al termine della procedura si accende verde. E' possibile ripetere la procedura senza particolari attenzioni.

 significa che non ci sono dati salvati nella Memory Card, ma è possibile ugualmente aggiornarne i valori.

45 - CARICAMENTO VALORI DI DEFAULT

Questa procedura permette di ripristinare le impostazioni di fabbrica dello strumento.

	Premere	Effetto	Eseguire
1	 per 3 secondi.	Il display dopo circa 5 secondi visualizza  con la prima cifra da sinistra lampeggiante.  nel caso del ATR141	
2	 o 	Si modifica la cifra lampeggiante si passa alla successiva con il tasto 	Inserire la password:  per ATR121  per ATR141
3	 per conferma	Lo strumento carica le impostazioni di fabbrica e si riavvia	

Esempio di sistema di controllo con supervisione e regolatori ATR121-AT. Sono evidenziati gli elementi del sistema, far attenzione in particolare al convertitore Rs232 / Rs485 con Dir. Automatico, e alla tipologia di cavo per rete dati.

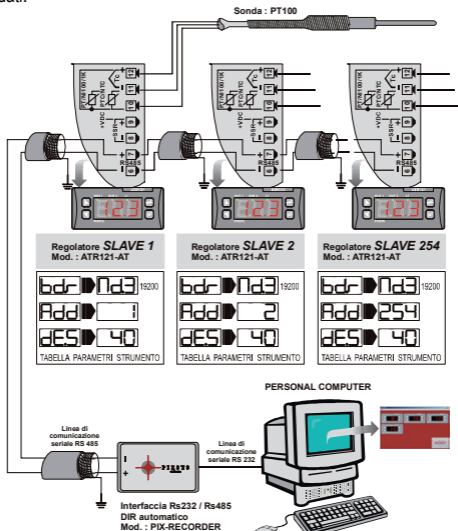

Utilizzare cavo schermato a 1 coppia di conduttori twistati conforme alle norme EIA RS-485. Cavo raccomandato: Belden 9841.

AN-0020-3704

47 - PROMEMORIA CONFIGURAZIONE

Data: Modello ATR121/141:
 Installatore: Impianto:
 Note:

Par.	Descrizione	Default	Prom.
COU	Tipo uscita comando	062	
SEN	Tipo di sensore	Ec F	
DP	Tipo di decimale	0	
Lo S	Limite inferiore setpoint	0	
Hi S	Limite superiore setpoint ATR121	999	
		1750	
	ATR141		
Lo R	Limite inferiore range per V/I V/mA	0	
Hi R	Limite superiore range per V/I V/mA	999	
LAE	Funzione Latch On	OFF	
CAL	Calibrazione offset	00	
GA	Calibrazione guadagno	00	
REG	Tipo regolazione	HEAT	
SC	Stato comando in caso di guasto	CO	
LED1	Stato led OUT1	CC	
HYS	Isteresi/banda morta	0	
PB	Banda proporzionale	0	
TI	Tempo integrale.	0	
TD	Tempo derivativo	0	
TC	Tempo ciclo proporzionale	10	
AL	Selezione allarme.	ALA	
CS.A	Contatto uscita allarme	NO5	

ScA	Stato allarme in caso di guasto	co	
LEd2	Stato del led	cc	
HYSA	Isteresi allarmi	0	
dELA	Ritardo allarme	0	
PSE	Protezione set.	FrEE	
FILT	Filtro software.	10	
tunE	Selezione auto-tuning	oFF	
Func	Selezione funzionamento	dSEt	
GrAd	Selezione gradi	°C	
bdrE	Baud rate	7db3	
Addr	Indirizzi slave	254	
dLSr	Ritardo seriale	20	
cooF	Liquido refrigerante	Air	
PbN	Moltiplicatore di banda proporzionale	100	
oudb	Sovrapposizione / Banda morta	0	
tc. 2	Tempo ciclo 2	10	
FLtu	Filtro in visualizzazione	oFF	

49 - IDENTIFICATION DU MODÈLE

Modèle ATR121

ATR121-	xx	x	
<i>Alimentation</i>	AD		12...24Vac \pm 10% 50/60Hz 12...35Vdc
	A		24 Vac \pm 10% 50/60 Hz
	B		230 Vac \pm 10% 50/60 Hz
	C		115 Vac \pm 10% 50/60 Hz
<i>Seriale</i>	A	T	RS485 avec protocole Modbus RTU Slave. Relais Q2 n'est pas disponible dans cette version et la fonction alarme est interdite. Seulement version AT: 24Vac \pm 10% 50/60 Hz Seulement version ADT: 12...35Vdc
	AD	T	

Modèle ATR141

ATR141-	xx	x	
<i>Alimentation</i>	AD		12...24Vac \pm 10% 50/60Hz 12...35Vdc
	A		24 Vac \pm 10% 50/60 Hz
	B		230 Vac \pm 10% 50/60 Hz
	C		115 Vac \pm 10% 50/60 Hz
<i>Seriale</i>	A	T	RS485 avec protocole Modbus RTU slave. Relais Q2 n'est pas disponible dans cette version et la fonction alarme est interdite. Seulement version AT: 24Vac \pm 10% 50/60 Hz Seulement version ADT: 12...35Vdc
	AD	T	

Caractéristiques générales		
Affichage	3 digits (0,56 pouces) ATR121 4 digits (0,40 pouces) ATR141 + 3 indicateurs lumineux (Out1 , Out2 , Fnc)	
Température ambiante	0-40°C - humidité 35..95uR%	
Protection	Façade IP65 (avec garniture) / Boîte IP30 / Raccordements électriques IP20	
Matière	Polycarbonate UL94V2 auto-extinguible	
Poids	ca. 100 g.	
Caractéristiques matériel		
<i>Entrées analogiques</i>	AN1 Programmable avec logiciel Thermocouples : K, S, R, J Thermorésistances: PT100, NI100, PT500, PT1000, PTC 1000 ohm , NTC 10Kohm Signaux: 0/4..20mA ($R_i \leq 4,7\text{ohm}$) 0...10V ($R_i \geq 110\text{Kohm}$) 0...6Kohm 0...150Kohm	Tolérance (25°C) 0.5 % \pm 1 digit pour thermocouples et thermoresistance s Joint froid 0.2°C/c de température ambiante 0.2% \pm 1 digit pour entrées normalisées

<i>Sorties</i>	2 Relais + SSR: OUT1: 10A charge résistive modèle AD , 8A charge résistive modèles avec transformateur OUT2: 5A charge résistive. SSR:8 Volt 20mA version A/B/C. 15Volt 30mA version AD (alim. 12Vac) 30Volt 30mA version AD (alim. 24Vac)
Caractéristiques logiciel	
<i>Algorithmes réglage</i>	ON/OFF avec hystérésis ou P.I.D. autoréglant
<i>Protection des données</i>	Paramètres sous le mot de passe Carte de mémoire pour une configuration rapide



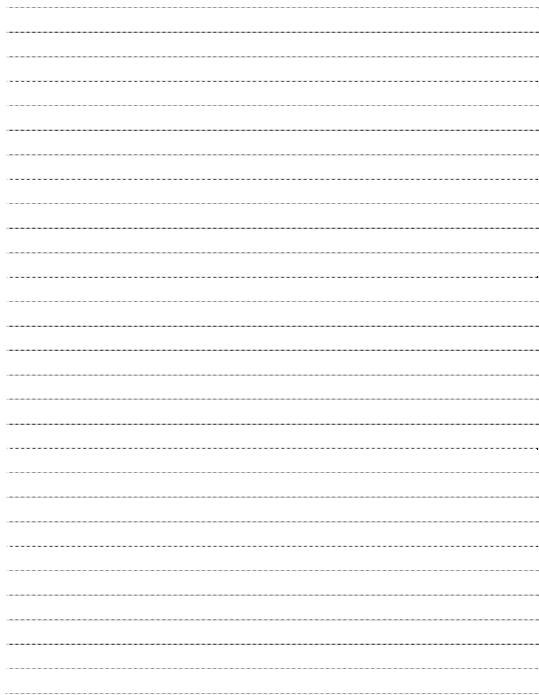



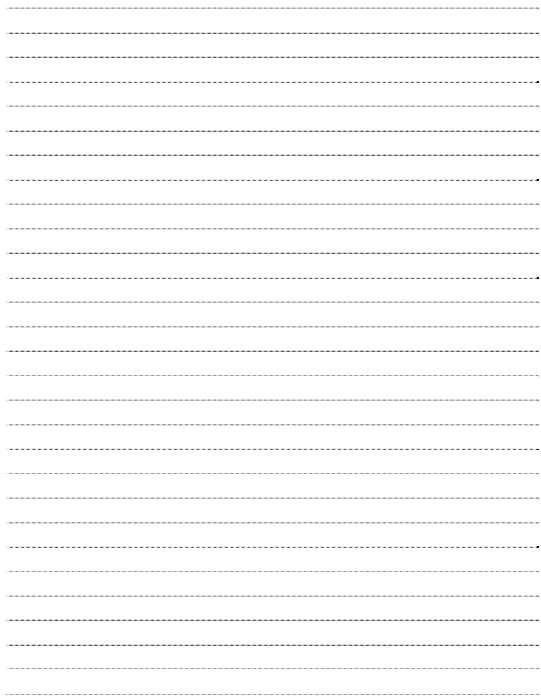

PIXSYS srl

Via Tagliamento, 18 - I - 30030 Mellaredo di Pianiga (VE)
www.pixsys.net - e-mail:sales@pixsys.net - support@pixsys.net

2300.10.056-RevD

031208

