

LX6EQ

Photoelectric Sensor – Opposed Mode Sensor (Emitter)

Emitter

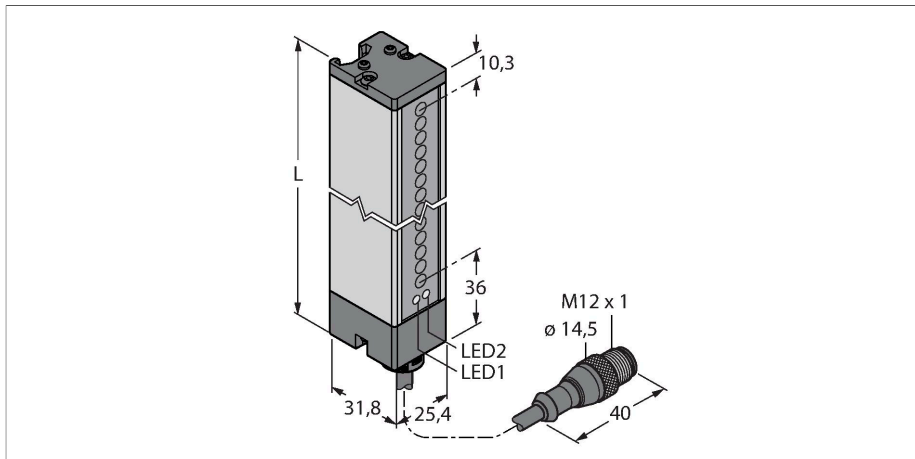

Technical data

Type	LX6EQ
ID	3002673
Optical data	
Function	Light screen
Operating mode	Emitter
Light type	IR
Wavelength	880 nm
Optical resolution	9.5 mm
Range	150...2000 mm
Scan field	143 mm
Electrical data	
Operating voltage	10...30 VDC
Residual ripple	< 10 % U _{ss}
No-load current	≤ 100 mA
Short-circuit protection	yes
Reverse polarity protection	yes
Response time typical	< 1.6 ms
Mechanical data	
Design	Rectangular, LX
Dimensions	31.8 x 25.4 x 189.6 mm
Housing material	Metal, AL, Grey
Lens	plastic, Acrylic
Electrical connection	Cable with connector, M12 × 1, 0.15 m, PVC
Number of cores	5
Core cross-section	0.5 mm ²

Features

- Cable with male end M12 × 1, 5-pin, 0.15 m
- Protection class IP65
- Scan field 143 mm
- Minimum target size 9.5 mm
- Operating voltage: 10 ... 30 VDC
- Programmable connection for reduced sensing range
- 2 slot nuts including M5 screws for wall mounting included in the scope of delivery

Wiring diagram

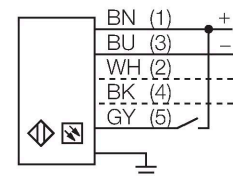

Functional principle

Light screens are used to monitor large areas. They consist of an emitter and a receiver. Switching light screens with scanning heights of up to 76 mm (LX3...) and up to 914 mm (LX36...) are available. The crossed beams of the LX light screen enable small objects and/or objects that are not standard shapes to be reliably detected.

Technical data

Ambient temperature	-20...+70 °C
Relative humidity	0...90 %
Protection class	IP65
Power-on indication	LED, Green
Error indication	LED, red, Flashing
Tests/approvals	
MTTF	74 years acc. to SN 29500 (Ed. 99) 40 °C
Approvals	CE, cURus



Accessories

SMBLX 3002915

Mounting bracket, galvanized steel, for LX series, 2 pcs., not included in delivery

SMBLXR 3002914

Foot, galvanized steel, for LX series

Accessories

Dimension drawing	Type	ID	
	MQDEC2-506	3060810	Anschlusskabel, PVC, geschirmt, Länge 1.83 m, M12 x 1 Kupplung 5-polig auf offenes Ende
	MQDEC2-506RA	3060813	Anschlusskabel, PVC, geschirmt, Länge 1.83 m, M12 x 1 Kupplung gewinkelt 5-polig auf offenes Ende
	RKC4.5T-2/TEL	6625016	Connection cable, female M12, straight, 5-pin, cable length: 2 m, sheath material: PVC, black; cULus approval; other cable lengths and qualities available, see www.turck.com
	WKC4.5T-2/TEL	6625028	Connection cable, female M12, angled, 5-pin, cable length: 2 m, sheath material: PVC, black; cULus approval; other cable lengths and qualities available, see www.turck.com