

## Description

The E3 is a high resolution rotary encoder with a molded polycarbonate enclosure, which utilizes either a 5-pin locking or standard connector. This optical incremental encoder is designed to easily mount to and dismount from an existing shaft to provide digital feedback information.

The E3 is easy to add to existing applications and only consists of four main components; base, cover, hubdisk and optical encoder module.

The E3 is normally designed for applications of 10 feet or less. For longer cable lengths, adding a PC4 / PC5 differential line driver is recommended.

The base and cover are both constructed of rugged 20% glass filled polycarbonate. Attachment of the base to a surface may be accomplished by utilizing one of several machine screw bolt circle options. Positioning of the base to the centerline of a shaft is ensured by use of a centering tool (sold separately). The cover is securely attached to the base with two 4-40 flat head screws to provide a resilient package protecting the internal components.

The internal components consist of a mylar disk mounted to a precision machined aluminum hub and an encoder module. The hub is available for diameters up to 1". The module consists of a highly collimated solid state light source and monolithic phased array sensor, which together provide a system extremely tolerant to mechanical misalignments.

Connection to the E3 product is made through either a 5-pin locking or standard connector (sold separately). The mating connectors are available from US Digital ½ with several cable options and lengths.

## Mechanical Drawing



## Features

- ▶ Quick, simple assembly and disassembly
- ▶ Rugged screw-together housing
- ▶ Accepts .010" axial shaft play
- ▶ Small size
- ▶ 64 to 10000 cycles per revolution (CPR)
- ▶ 256 to 40000 pulses per revolution (PPR)
- ▶ 2 channel quadrature TTL squarewave outputs
- ▶ Optional index (3rd channel)

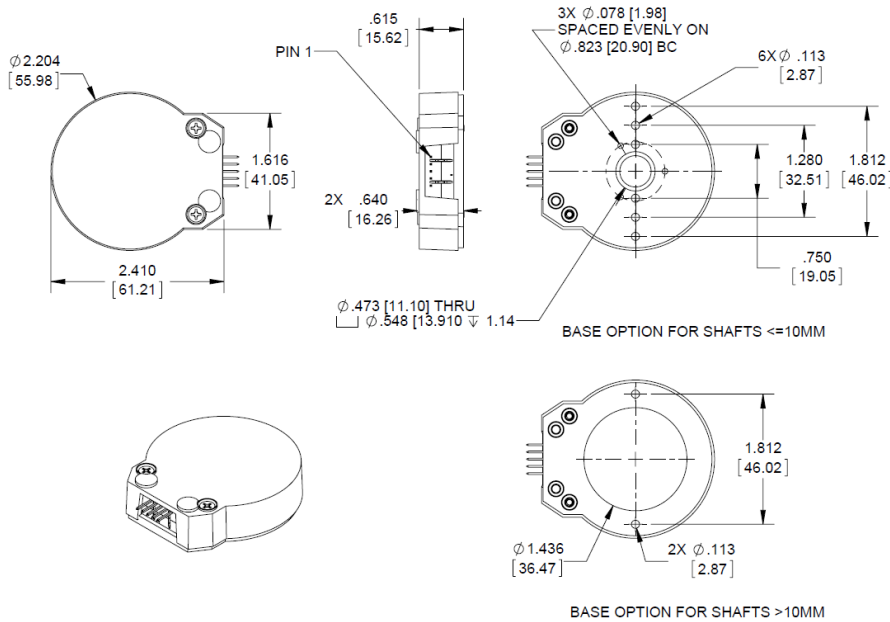

**Environmental**

Parameter	Value	Units
Operating Temperature (CPR < 3600)	-40 to 100	C
Operating Temperature (CPR ≥ 3600)	-25 to 100	C
Vibration (5Hz to 2kHz)	20	G
Electrostatic Discharge, IEC 61000-4-2	± 4	kV

**Mechanical**

Parameter	Value	Units
Max. Shaft Axial Play	±0.010	in.
Max. Shaft Eccentricity Plus Radial Play (1)	0.004	in.
Max. Acceleration	250000	rad/sec <sup>2</sup>
Max. RPM (2) (CPR ≤ 2500) e.x. CPR=2500, max. rpm=7200 e.x. CPR=100, max. rpm=60000	minimum value of ((18 x 10 <sup>6</sup> ) / CPR) and (60000)	rpm
Max. RPM (2) (CPR > 2500 and ≤ 5000) e.x. CPR=4096, max. rpm=5273	(21.6 x 10 <sup>6</sup> ) / CPR	rpm
Max. RPM (2) (CPR > 5000) e.x. CPR=10000, max. rpm=4320	(43.2 x 10 <sup>6</sup> ) / CPR	rpm

Parameter	Value	Units
Typical Product Weight	1.28	oz.
Codewheel Moment of Inertia	8.9 x 10 <sup>-5</sup> for bore < 12mm 4.0 x 10 <sup>-4</sup> for bore ≥ 12 mm	oz-in-s <sup>2</sup>
Hub Set Screw	#3-48 or #4-48	
Hex Wrench Size	0.050	in.
Encoder Base Plate Thickness	0.135	in.
3 Mounting Screw Size	#0-80	
3 Screw Bolt Circle Diameter (3)	0.823 ± 0.005	in.
2 Mounting Screw Size	#2-56 or #4-40	
2 Screw Bolt Circle Diameter	0.750 ± 0.005	in.
2 Screw Bolt Circle Diameter	1.280 ± 0.005	in.
2 Screw Bolt Circle Diameter	1.812 ± 0.005	in.
Required Shaft Length (4)	0.445 to 0.525	in.
With E-option (3)	0.445 to 0.670	in.
With H-option	> 0.445	in.
Index alignment to hub set screw	180 ± Typical	mechanical degrees
Technical Bulletin TB1001 - Shaft and Bore Tolerances		<a href="#">Download</a>

(1) Position inaccuracy is proportional to shaft radial play.

(2) 60000 rpm is the maximum rpm due to mechanical considerations. The maximum rpm due to the module's 300kHz maximum count frequency is  $(18 \times 10^6) / \text{CPR}$ .

(3) Only for shaft diameters < 0.472".

(4) Add 0.125" to all required shaft lengths when using M-option.

## Torque Specifications

Parameter	Torque
Hub Set Screw to Shaft	2-3 in-lbs
Cover (4-40 screws through cover into base)	2-4 in-lbs
Base to Mounting Surface	4-6 in-lbs
Base to Mounting Adapter Plate	4-6 in-lbs
Adapter Plate to Mounting Surface	4-6 in-lbs
Module to Base	3.5-4 in-lbs

## Phase Relationship

A leads B for clockwise shaft rotation, and B leads A for counterclockwise rotation viewed from the cover/label side of the encoder.

## Electrical

- Specifications apply over entire operating temperature range.
- Typical values are specified at  $V_{cc} = 5.0V_{dc}$  and  $25^{\circ}C$ .
- For complete details, see the EM1 and EM2 product pages.

Parameter	Min.	Typ.	Max.	Units	Conditions
Supply Voltage	4.5	5.0	5.5	V	
Supply Current		27	33	mA	CPR < 1000, no load
		54	62	mA	CPR ≥ 1000 and < 3600, no load
		72	85	mA	CPR ≥ 3600, no load
Low-level Output			0.5	V	IOL = 8mA max., CPR < 3600
			0.5	mA	IOL = 5mA max., CPR ≥ 3600
		0.05		mA	no load, CPR < 3600
		0.25		mA	no load, CPR ≥ 3600
High-level Output	2.0			V	IOH = -8mA max., CPR < 3600
	2.0			V	IOH = -5mA max., CPR ≥ 3600
		4.8		V	no load, CPR < 3600
		3.5		V	no load, CPR ≥ 3600
Output Current Per Channel	-8		8	mA	CPR < 3600
	-5		5	mA	CPR ≥ 3600
Output Rise Time		110		nS	CPR < 3600
		50		nS	CPR ≥ 3600
Output Fall Time		35		nS	CPR < 3600
		50		nS	CPR ≥ 3600

## Pin-out

Pin	Description
1	Ground
2	Index
3	A channel
4	+5VDC power
5	B channel

**Note:** 5-pin single ended mating connector is CON-C5 or CON-LC5

## Options

### Index

Provides a single pulse per revolution.



### E-option

The **E**-option provides a cylindrical extension to the cover allowing for longer shafts of up to .670". This option is only for shaft diameters < .472".



### H-option

The **H**-option adds a hole to the cover for the shaft to pass through.

- Shafts ≤ 1/2", a 0.55" diameter hole is supplied.
- Shafts > 1/2", a 1.05" diameter hole is supplied.



### M-option

These adapter plates are for mounting to a 3" diameter bolt circle.



### T-option

When mounting holes are not applicable, a pre-applied transfer adhesive mounting option is available.

**Instructions:** The T-option includes transfer adhesive with a peel-off backing on the encoder base. First, peel the paper backing from the transfer adhesive. Next, align the centering tool with the center hole on the non-adhesive side of the encoder base. Slide the base (adhesive side down) with the centering tool over the motor shaft and press firmly to form a solid bond between the encoder base and mounting surface. Remove the centering tool and continue with the standard assembly. You are required to use the centering tool with the T-option to ensure proper placement.

## Assembly Instructions

### For Shafts Less Than or Equal To 0.394" (10mm):

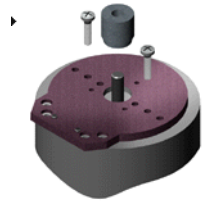

**1. Base Mounting**

Secure the base to the mounting surface using two or three screws (sold separately). If a centering tool is used, slip it over the shaft and into the center hole of the base. Tighten the mounting screws and then remove the centering tool.

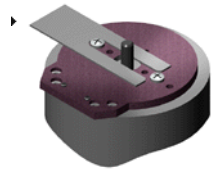

**2. Spacer Installation**

Place the spacer tool around the shaft, flat on the base.

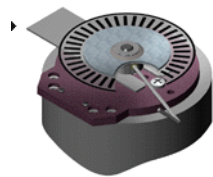

**3. Hub/Disk Assembly Installation**

Slip the hub over the shaft until it bottoms out against the spacer tool. Tighten the set screw with the hex wrench provided while pressing down on the hub. Remove the spacer tool.

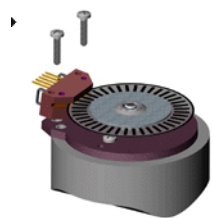

**4. Encoder Module Installation**

Orientate the module with the connector pins toward the top. Slide the module from front to back, being careful not to damage the disk. Stop when the two alignment pins on the base fit into the holes of the module. Secure with two 4-40 1/2" pan head screws (supplied).

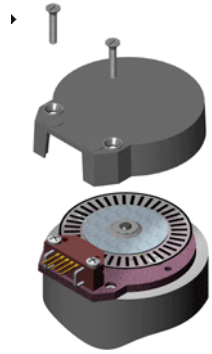

**5. Cover Installation**

Place the cover over the assembly and secure with the two 4-40 5/8" flat head screws provided.

**For Shafts Greater Than 0.394" (10mm):**

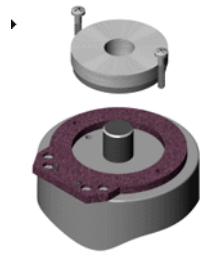

**1. Base Mounting**

Secure the base to the mounting surface using two or three screws (sold separately). If a centering tool is used, slip it over the shaft and into the center hole of the base. Tighten the mounting screws and then remove the centering tool.

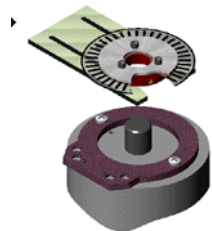

**2. Spacer Installation**

Push the spacer tool onto the bottom section of the hub/disk assembly. Make sure the spacer tool snaps only on the lower part of the hub. Align hub set screws as shown in drawing.

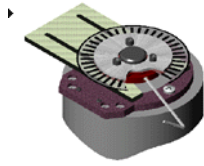

### 3. Hub/Disk Assembly Installation

Slip the hub over the shaft until it bottoms out against the spacer tool. Make sure the spacer tool clears the mounting screws on the base. Tighten both set screws with the hex wrench provided while pressing down on the hub. Remove the spacer tool.

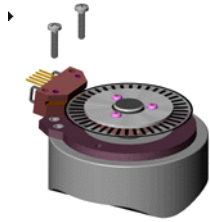

### 4. Encoder Module Installation

Orientate the module with the connector pins toward the top. Slide the module from front to back, being careful not to damage the disk. Stop when the two alignment pins on the base fit into the holes of the module. Secure with two 4-40 1/2" pan head screws (supplied).

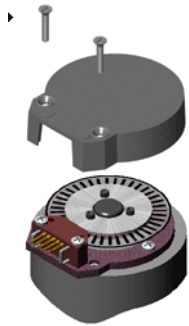

### 5. Cover Installation

Place the cover over the assembly and secure with the two 4-40 5/8" flat head screws (supplied).

## Accessories

### 1. Centering Tool

The centering tool is only included with the **-3** packaging option. It has to be ordered separately for other packaging options.

**Part #: CTOOL - (Shaft Diameter)**

**Description:** This reusable tool provides a simple method for accurately centering the E3 base onto the shaft in order to promote concentricity and thus, higher accuracy. It is recommended for the following situations:

- ▶ When using mounting screws smaller than #4-40.



- › When the position of the mounting holes is in question.
- › When using the 3-hole mounting pattern.
- › When using the T-option transfer adhesive.

**Instructions:** When mounting encoder base, slide centering tool down shaft until it slips into centering hole of encoder base. Tighten mounting screws, then remove centering tool.

## 2. Hex Tool

Depending on the order packaging option, either a hex driver or hex wrench is included.

**Part #: HEXD-050**

**Description:** Hex driver, 0.050" flat-to-flat for #3-48 or #4-48 set screws. Only included with **-B** or **-1** packaging options.

**Part #: HEXW-050**

**Description:** Hex wrench, 0.050" flat-to-flat for #3-48 or #4-48 set screws. Only included with **-2** or **-3** packaging options.

## 3. Spacer Tool

A spacer tool is included for all packaging options.

**Part #: SPACER-E3S**

**Description:** For shafts  $\leq 0.394$ "

**Part #: SPACER-E3L**

**Description:** For shafts 12mm - 1"

## 4. Screws

Screws for base mounting must be purchased separately. Screws for mounting the housing to the base are included.

**Part #: SCREW-080-250-PH**

**Description:** Pan Head, Philips #0-80 UNF x 1/4"

**Quantity Required for Mounting:** 3 per encoder

**Part #: SCREW-256-250-PH**

**Description:** Pan Head, Philips #2-56 UNC x 1/4"

**Quantity Required for Mounting:** 2 per encoder

**Part #: SCREW-440-250-PH**

**Description:** Pan Head, Philips #4-40 UNC x 1/4"

**Quantity Required for Mounting:** 2 per encoder



## Output Waveforms

SINGLE-ENDED

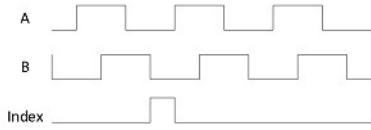

### Ordering Information

E3 -  -  -  -  -  -

CPR	Bore	Index	Cover	Base	Packaging
64	079 =	NE =No	D =Default	D =Default	B =Encoder components packaged in bulk. One spacer tool and one hex wrench for orders up to 9 units, for orders of 10...
100	2mm	Index	E =Cover	M =4-hole	1 =Encoders individually packaged. One spacer tool and one hex wrench for orders up to 9 units, for orders of 10...
200	118 =	IE =Index	Extension	mounting adapter	2 =Encoders packaged individually with one spacer tool and one hex wrench per encoder.
400	3mm		H =Hole in	plate	3 =Encoders packaged individually with one spacer tool, one hex wrench, and one centering tool per encoder.
500	125 =1/8"		Cover	T =Transfer adhesive	
512	156 =				
1000	5/32"				
1024	157 =				
1800	4mm				
2000	188 =				
2048	3/16"				
2500	197 =				
3600	5mm				
4000	236 =				
4096	6mm				
5000	250 =1/4"				
7200	313 =				
8000	5/16"				
8192	315 =				
10000	8mm				
	375 =3/8"				
	394 =				
	10mm				
	472 =				
	12mm				
	500 =1/2"				
	551 =				
	14mm				
	625 =5/8"				
	750 =3/4"				
	787 =				
	20mm				
	875 =7/8"				
	984 =				
	25mm				
	1000 =1"				

## Notes

- US Digital® warrants its products against defects in materials and workmanship for two years. See complete warranty for details.