



▶ Permanent magnet stepper motors

**6231 A**

- Step angle ..... 7.5°
- Diameter ..... 42 mm
- Weight ..... 120 g
- Holding torque ..... 75/61 mNm

Compact in size, light and noiseless this motor is used when low power is needed. Easily integrated in a wide range of applications.

▶ Technical data

	Part N°	Phase resistance [Ω]	Phase inductance [mH]	Phase current [A]	Holding torque [mNm]	Nominal power [W]	Cable code
Bipolar	6231-2A-17.5	17.5	23	0.34	75	4	Red
	6231-2A-70	70	94	0.17	75	4	Blue
Unipolar	6231-4A70	70	53	0.17	61	4	Blue

Steps/rev.	48
Step accuracy	± 7%
Rotor inertia	12 gcm <sup>2</sup>
Insulation class	E 120 °C
Protection	DIN 40050 IP 30
Test voltage	500 VAC
Detent torque	7.5 mNm

▶ Dimensions

Drawing not to scale. All dimensions in mm

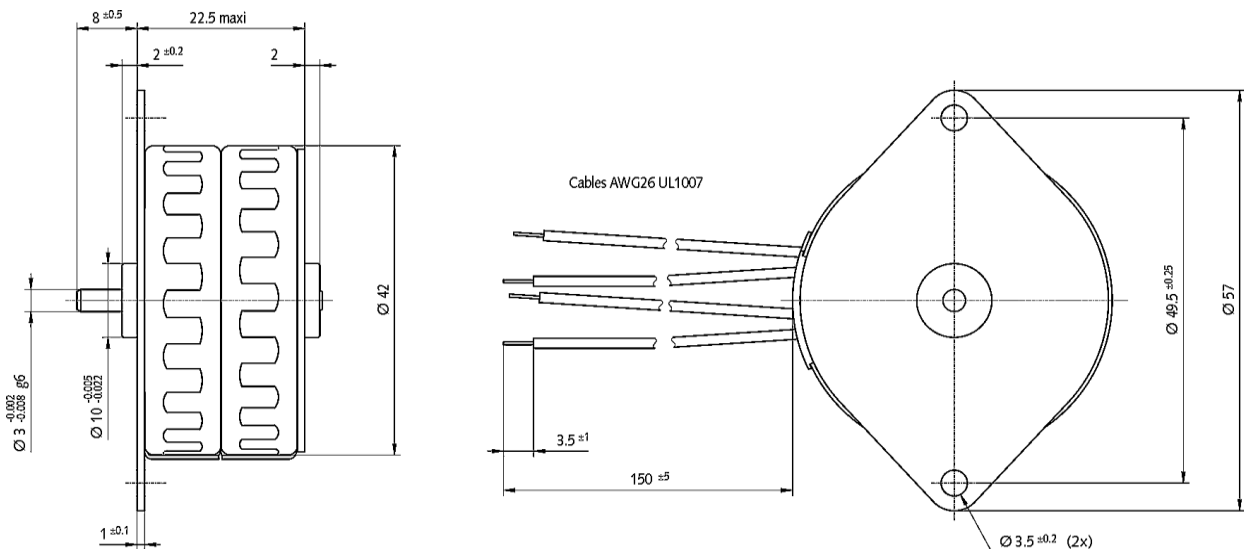

► Dynamic characteristics

• 6231-2A-17.5

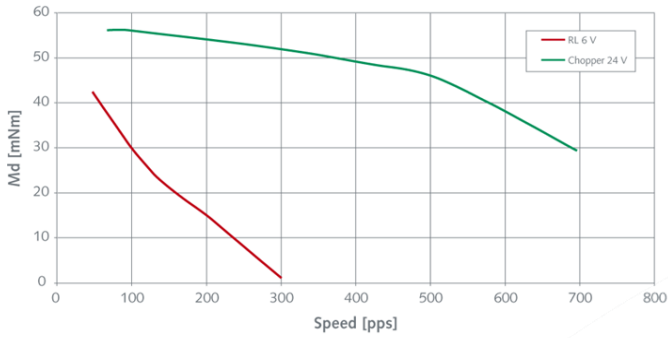

• 6231-2A-70

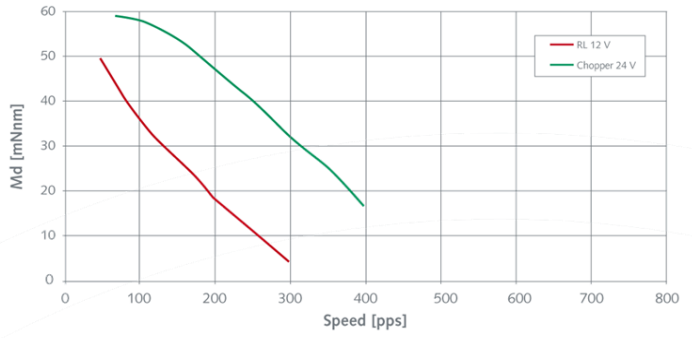

• 6231-4A-70

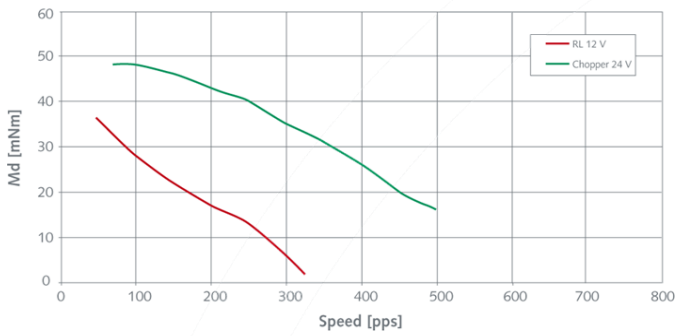

[pps] = pulses per second

► Static characteristics

• 6231-2A

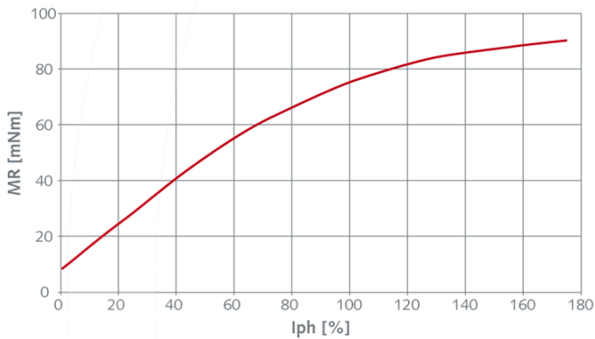

• 6231-4A

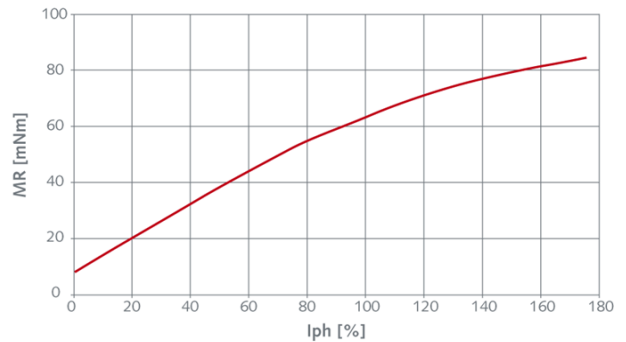

► Electrical Interface

• Bipolar

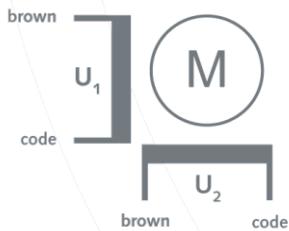

• Unipolar

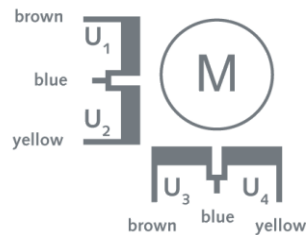

Special requirements upon customer specifications. Right to change without notifications reserved.

<2.0>

SONCEBOZ SA

2605 Sonceboz – Switzerland

Tel. +41(0) 32 488 11 11

Fax +41(0) 32 488 11 00

info@sonceboz.com - www.sonceboz.com

