

Characteristics

The D1MW is based on the D1VW series of directional control valves size NG06, but offers additional corrosion protection of the valve body, the solenoid coil and the anchor tube as well as the typical solenoid connections for the mobile market such as AMP Junior Timer and DT04-2P “Deutsch”.

Technical features

- High corrosion protection (optional)
- Solenoid connection:
 - Standard (as per EN175301-803)
 - AMP Junior Timer
 - DT04-2P “Deutsch”
- Robust design for rough applications
- Extended manual override with rubber cover (optional)



With AMP Junior Timer

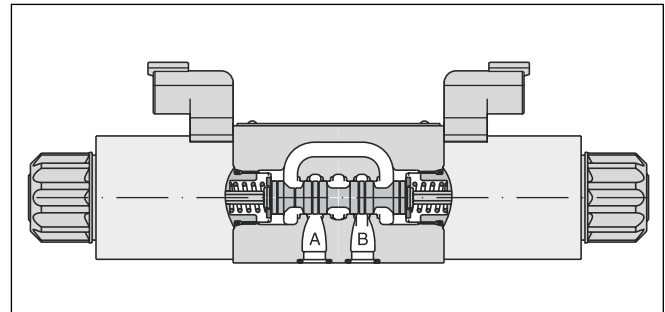
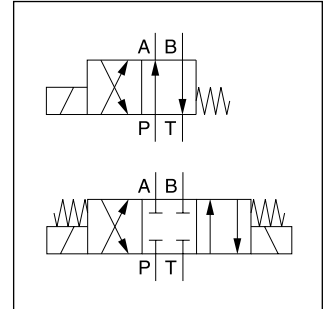

Connector DT04-2P “Deutsch”

Technical data

General	
Design	Directional spool valve
Actuation	Solenoid
Size	DIN NG06 / CETOP 03 / NFPA D03
Mounting interface	DIN 24340 A6 / ISO 4401 / CETOP RP 121-H / NFPA D03
Mounting position	Unrestricted, preferably horizontal
Ambient temperature	[°C] -25...+60
MTTF _D value	[years] 150
Weight	[kg] 1.5 (1 solenoid), 2.1 (2 solenoids)
Vibration resistance	[g] 10 Sinus 5...2000 Hz acc. IEC 68-2-6
	30 Random noise 20...2000 Hz acc. IEC 68-2-36
	15 Shock acc. IEC 68-2-27
Hydraulic	
Max. operating pressure	[bar] P, A B: 350; T: 210
Fluid	Hydraulic oil according to DIN 51524
Fluid temperature	[°C] -20 ... +70 (NBR: -25...+70)
Viscosity permitted	[cSt] / [mm ² /s] 2.8...400
Viscosity recommended	[cSt] / [mm ² /s] 30...80
Filtration	ISO 4406 (1999); 18/16/13
Flow max.	[l/min] 80 (see shift limits)
Leakage at 50 bar	[ml/min] Up to 10 per flow path, depending on spool
Static / Dynamic	
Step response at 95 %	[ms] Energized: 32 De-energized: 40
Electrical characteristics	
Duty ratio	100 % ED; CAUTION: coil temperature up to 150 °C possible
Max. switching frequency	[1/h] 15000
Protection class	Standard (as per EN175301-803) IP65 acc. EN60529 (w. corr. mount. plug-in connector) AMP Junior Timer IP67 in acc. with EN60529 (with correctly mounted plug-in connector) DT04-2P “Deutsch” IP69K (with correctly mounted plug-in connector)
	Code
Supply voltage	[V] K 12 V = J 24 V =
Tolerance supply voltage	[%] ±10 ±10
Current consumption hold	[A] 2.72 1.29
Power consumption hold	[W] 32.7 31
Solenoid connection	Connector as per EN 175301-803 (code W), AMP Junior Timer (code A), DT04-2P “Deutsch” connector (code J). Solenoid identification as per ISO 9461.
Wiring min.	[mm ²] 3 x 1.5 recommended
Wiring length max.	[m] 50 recommended

With electrical connections the protective conductor (PE ⚡) must be connected according to the relevant regulations.

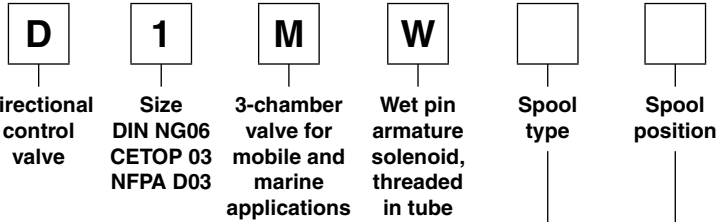

2

3 position spools	
Code	Spool type
	a 0 b
001	
002	
003	
004	
005	
006	
007	
008 ¹⁾	
009 ¹⁾	
010	
011	
014	
015	
016	
021	
022	
031	
032	
034	
035	
061	
081	
082	
102	
204 ¹⁾	
205 ¹⁾	

2 position spools	
Code	Spool type
	a b
020	
026	
030	
083 ¹⁾	
101	
208	

3 position spools			
Code	Spool position		
C			3 positions. Spring offset in position "0". Operated in position "a" or "b".
	Standard	Spool type 008, 009, 204, 205	
E	 Operated in position "a".	 Operated in position "b".	2 positions. Spring offset in position "0".
F	 Spring offset in position "b".	 Spring offset in position "a".	2 positions. Operated in position "0".
K	 Operated in position "b".	 Operated in position "a".	2 positions. Spring offset in position "0".
M	 Spring offset in position "a".	 Spring offset in position "b".	2 positions. Operated in position "0".

2 position spools			
Code	Spool position		
	Standard	Spool type 083	
B	 Operated in position "b".	 Operated in position "a".	2 positions. Spring offset in position "b". Operated in position "a".
D	 Operated in position "a" or "b".	—	2 positions. Operated in position "a" or "b". No center or offset position.
H	 Spring offset in position "a".	 Spring offset in position "b".	2 positions. Spring offset in position "a". Operated in position "b".

1) Consider specific spool position.
 2) Please order plug separately.
 3) Only in combination with connection "J" and "W".

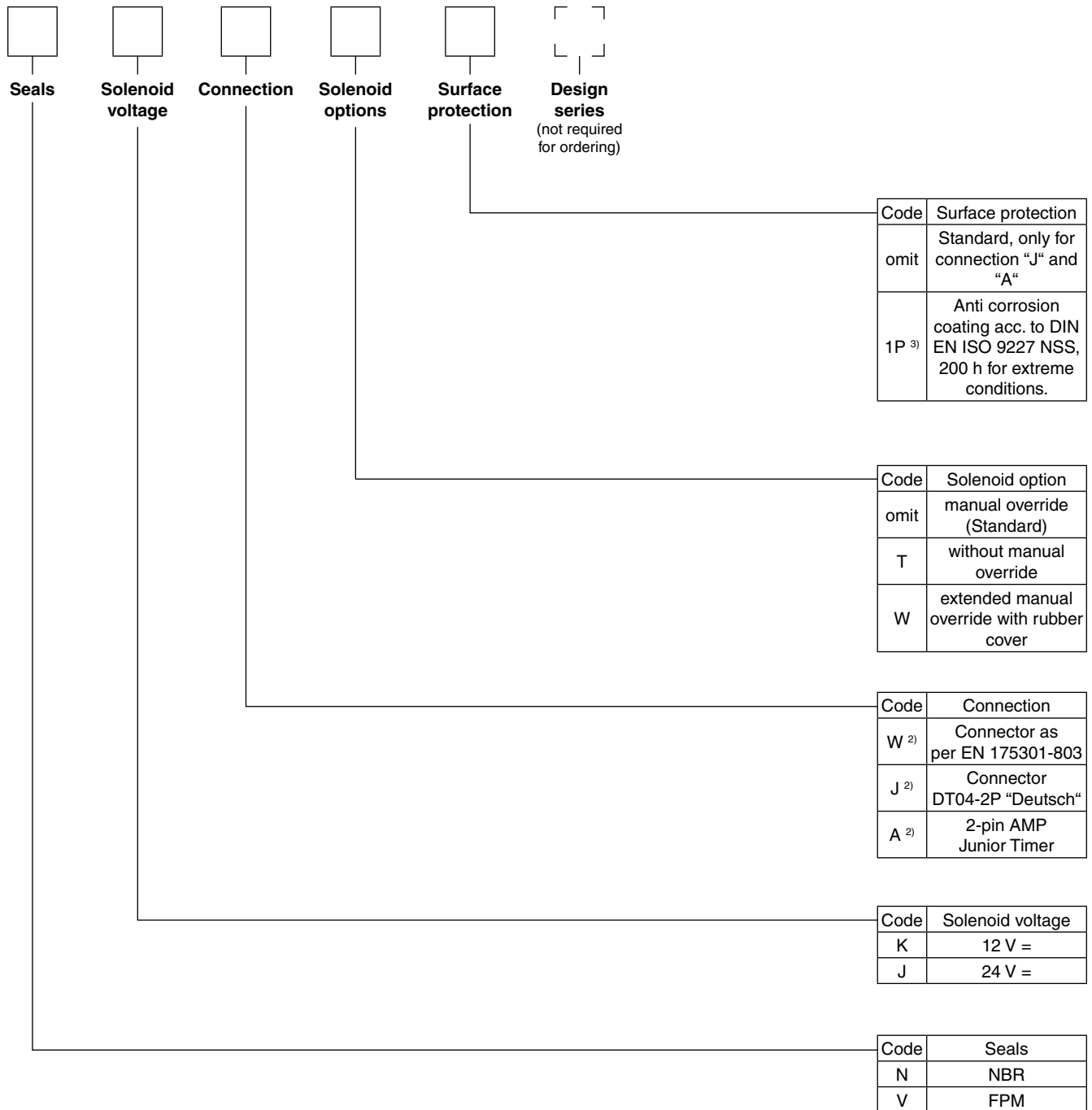

Other spool types on request.

Flow curves

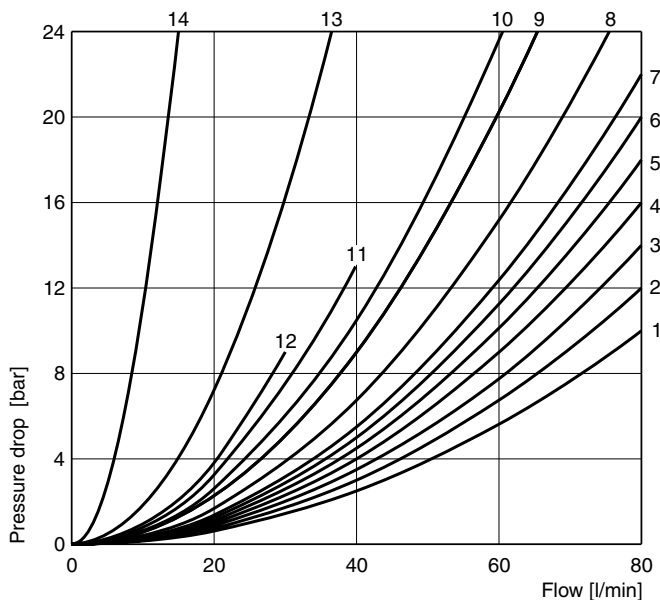

All characteristic curves measured with HLP46 at 50 °C.

Spool	Position "b"			Position "a"			Position "0"				
	P-A	B-T	P-B	P-B	A-T	P-A	P-A	P-B	A-T	B-T	P-T
001	2	2		2	2						
002	1	4		1	4						
003	3	4		3	6		1	1	5	5	2
004	2	3		2	3				7	7	
005	2	2		2	2		12				
006	1	4		1	4		7	7			
007	3	2		2	2			3		2	7
010	3			3							
011	2	2		2	2				14	14	
014	3	2		2	2		3		2		7
015	3	6		3	4					7	
016	2	2		2	2			12			
020B	4	4		2	3						
026B	4			4							
030B	2	3		1	2						
034	4		8	3	3				5	7	
035	3	3		4		8			7	5	
081	13	13		13	13						
082	13	13		13	13				1)	1)	
101B	11	10		10	9						
102	1	4		1	4		5	5	8	8	6
61	1	3		1	3		3	2			
83H	5	2		5	2						
208	3			2							
	P-B	A-T		P-A	B-T		P-A	P-B	A-T	B-T	P-T
008	4	5		4	5						9
009	5	5		6	7						7
83B	5	2		5	2						
204	1	3		4	3		7		4		7
205	4	3		1	3			7		4	5

Spool	Position "b"			Position "a"		
	P-A	P-B	A-B	P-B	A-T	
021	2	4		4	2	
	P-A	B-T		P-A	P-B	A-B
022	6	2		5	2	

1) Only for pressure compensation, no high flow possible.

Shift limits, DC voltage

The diagram below specifies the shift limits for valves with DC & AC solenoids. Valves with spool position “F” or “M” can only be operated up to 70 % of the limits. The specifications apply to a viscosity of 40 mm²/s and bal-

anced flow conditions. The shift limits can be considerably lower at unbalanced flow conditions. To avoid flow rates beyond the shift limits, a plug-in orifice can be inserted in the P-port.

2

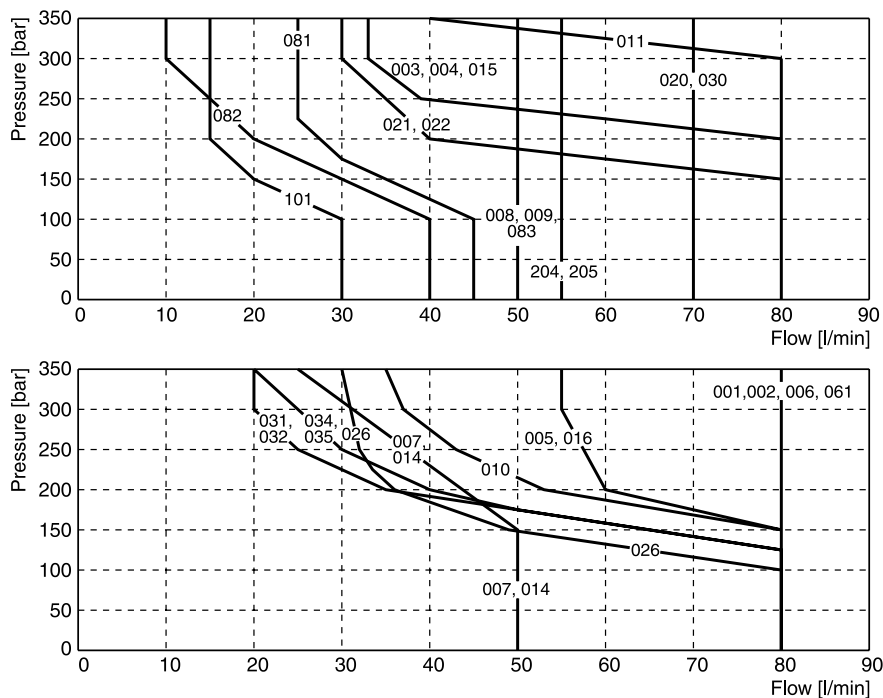

Measured with HLP46 at 50 °C, 90 % U_{nom} and warm solenoids

Dimensions with EN 175301-803 Connector

B, E, F -style

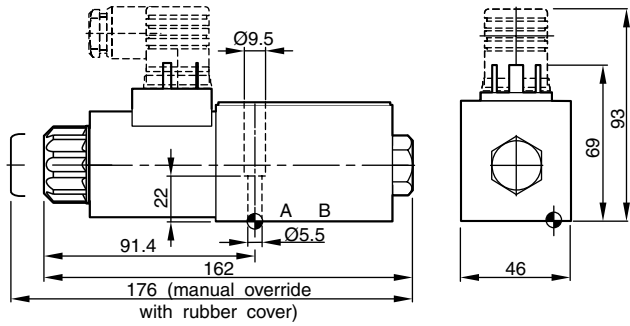

H, K, M -style

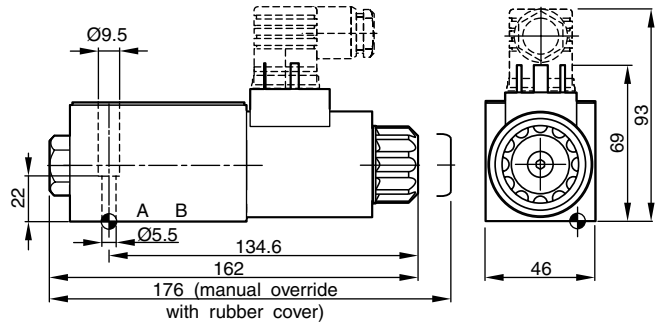

C and D -style

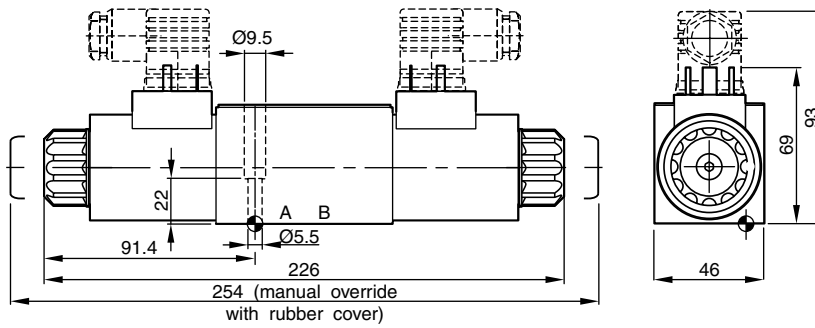



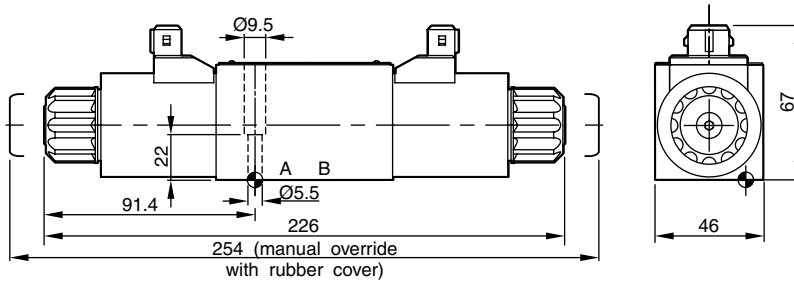

Dimensions with 2pin AMP Junior Timer Connector (only C and D -style shown)

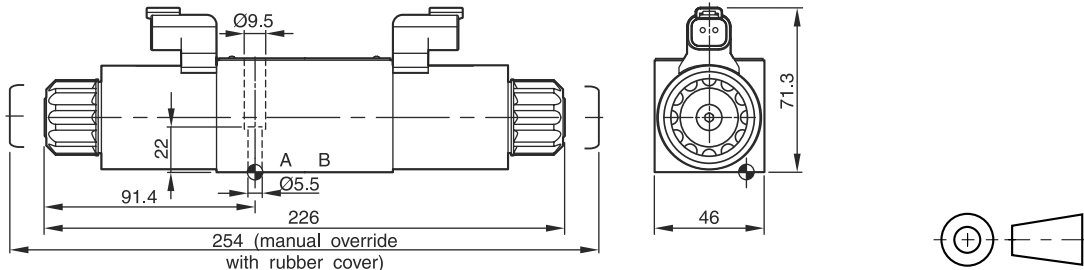

Dimensions with "Deutsch" DT04-2P Connector (only C and D -style shown)

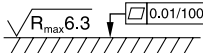

Surface finish	 Kit	 Kit	 Kit	 Kit
	BK375	4x M5x30 ISO 4762-12.9	7.6 Nm ±15 %	NBR: SK-D1VW-N-91 FPM: SK-D1VW-V-91

The space necessary to remove the plug per EN 175301-803, design type AF is at least 15 mm.
 The torque for the screw M3 of the plug has to be 0.5 to 0.6 Nm.