

















Ø30mm Series Control Units







ø30 ø30 series Control Units (Selection Guide)











Function	XN Series Emergency Stop Switch				HN Series Emergency Stop Switch
Category	Plastic Bezel		Flush Bezel	Padlockable	-
	Pushlock Pull/Turn Reset		Pushlock Pull/Turn Reset	Pushlock Turn Reset	Pushlock Turn Reset
Shape	 cUL US LISTED CE CCC	 ø60mm Mushroom cUL US LISTED CE CCC	 cUL US LISTED CE CCC	 cUL US LISTED CE CCC	 cUL US LISTED CE CCC
Model	XN1E-BV4 XN1E-LV4 XN1E-TV4	XN1E-BV5	XN5E-BV4 XN5E-LV4 XN5E-TV4	XN4E-BL4 XN4E-LL4 XN4E-TL4	HN1E-BV4 HN1E-LV4
Page	7		8	9	14











Function	Pushbutton							
Category	Flush		Extended		Extended with Half Shroud		Extended with Full Shroud	
	Momentary/Maintained							
Shape	 UL LISTED SP CE CCC	 UL LISTED SP CE CCC	 UL LISTED SP CE CCC	 UL LISTED SP CE CCC	 UL LISTED SP CE CCC	 UL LISTED SP CE CCC	 UL LISTED SP CE CCC	 UL LISTED SP CE CCC
Model	ABN1 AON1	(Diecast) ABD1 AOD1	ABN2 AON2	(Diecast) ABD2 AOD2	ABN2G AON2G	(Diecast) ABGD2 AOGD2	ABN2F AON2F	(Diecast) ABFD2 AOFD2
Page	22	82	22	82	22	82	22	82







Function	Pushbutton									
Category	Mushroom		Mushroom with Full Shroud		Palm Mushroom		Jumbo Mushroom with Shallow Shroud		Jumbo Mushroom with Deep Shroud	
	Momentary/Maintained				Momentary					
Shape	 UL LISTED SP CE CCC	 UL LISTED SP CE CCC	 UL LISTED SP CE CCC	 UL LISTED SP CE CCC	 UL LISTED SP CE CCC	 UL LISTED SP CE CCC	 UL LISTED SP CE CCC	 UL LISTED SP CE CCC	 UL LISTED SP CE CCC	 UL LISTED SP CE CCC
Model	ABN3 AON3	(Diecast) ABD3 AOD3	ABN3G	(Diecast) ABGD3 AOGD3	ABN4	(Diecast) ABD4	ABN4G	(Diecast) ABGD4	ABN4F	(Diecast) ABFD4
Page	23	83	23	83	23	83	23	83	23	83











Function	Pushbutton								
Category	Key ON/OFF Lock	Mushroom Pushlock Turn Reset		Mushroom Push Turn Lock		Mushroom Pushlock Key Reset		Jumbo Mushroom Pushlock Key Reset	
Shape	 UL LISTED SP CE CCC	 UL LISTED SP CCC	 UL LISTED SP CE CCC	 UL LISTED SP CE CCC	 UL LISTED SP CCC	 UL LISTED SP CCC	 UL LISTED SP CCC		
Model	ABN5	AVN3	(Diecast) AVD3	AJN3	(Diecast) AJD3	ABN3K	ABN4K		
Page	24	24	84	24	84	24	24		

ø30 Series Control Units (Selection Guide) ø30

Function	Pushbutton							
Category	Toggle Lever	Pin Lock		Mushroom Pull		Mushroom Push-Pull		Square Flush Momentary
Shape	 	 	(Diecast) ABD8P	 	(Diecast) AZD3	 	(Diecast) AYD31	 
Model	ATN4	ABN8P	(Diecast) ABD8P	ATN23	(Diecast) AZD3	ATN21 ATN22	(Diecast) AYD31	UBQN1
Page	24	25	84	25	84	25	84	23

Function	Pushbutton			Twin Maintained Pushbutton	
Category	Square Extended Momentary	Square Twin Momentary	Square Twin Maintained	Flush Twin Maintained	Mushroom Twin Maintained
Shape	 	 	 	 	 
Model	UBQN2	UWQN1	UWQN2	ABBN11	ABBN33
Page	23	26	26	26	26

Function	Pilot Light (LED)			
Category	Dome	Square	Rectangular (Marking)	
Shape	 	 	 	
Model	APN1 APNE1	(Diecast) APD1 APDE1	UPQN3B	UPQN4 UPQNE4
Page	27	85	28	28

Function	Pilot Light (Incandescent)				
Category	Dome (1W)	Dome (2W)	Rectangular (Marking) (1W/2W)	Square Flush (1W)	Dome (1W) Push-to-Check
Shape	 	 	 	 	 
Model	APN1	(Diecast) APD1 APNE1	UPQN4 UPQNE4	UPQN3B	APN1*P
Page	27	85	28	28	30

ø30 ø30 series Control Units (Selection Guide)









Function	Illuminated Pushbutton (LED)									
Category	Extended		Extended with Half Shroud		Extended with Full Shroud		Mushroom		Mushroom Pushlock Turn Reset	
	Momentary/Maintained									
Shape										
Model	ALN2 ALNE2 AOLN2 AOLNE2	(Diecast) ALD2 AOLD2	ALGN2 ALGNE2 AOLGN2 AOLGNE2		ALFN2 ALFNE2 AOLFN2 AOLFNE2	(Diecast) ALFD2 AOLFD2	ALN3 ALNE3 AOLN3 AOLNE3	(Diecast) ALD3 AOLD3	AVLN3 AVLNE3	(Diecast) AVLD3 AVLDE3
Page	31	86	33		35	87	37	88	40	89









Function	Illuminated Pushbutton (LED)	Illuminated Pushbutton (Incandescent)					
Category	Mushroom Push Turn Lock	Extended		Extended with Half Shroud	Extended with Full Shroud	Square Flush	
		Momentary/Maintained		Momentary	Momentary/Maintained		
Shape							
Model	AJLN3	ALN ALNE AOLN AOLNE	(Diecast) ALD2 AOLD2	ALN□G ALNE□G	ALN□F ALNE□F AOLN□F AOLNE□F	(Diecast) ALFD2 AOLFD2	ULQN UOLQN
Page	40	32	86	34	36	87	38

Function	Illuminated Pushbutton (Incandescent)				
Category	Rectangular	Turn Lock	Mushroom Pushlock Turn Reset	Mushroom Push Turn Lock	
	Momentary/Maintained				
Shape					
Model	ULQN□B UOLQN□B	ALN□L	AVLN3 AVLNE3	(Diecast) AVLD3 AVLDE3	AJLN3
Page	38	39	41	89	41

Function	Selector Switch				Illuminated Selector Switch (LED/Incandescent)		
Category	Knob	Lever		Key		Knob	
Shape							
Model	ASN ASTN	(Diecast) ASD	ASN□L ASTN□L	(Diecast) ASD□L	ASN□K ASTN□K	(Diecast) ASD□K	ASLN ASLD
Page	42, 49	90	44, 50	91	46, 51	92	52 93

ø30 Series Control Units (Selection Guide) ø30

Function	Selector Pushbutton				Mono-Lever Switch	
Category	Ring		Lever		Standard	Interlocking
Shape	 		 		 	 
Model	ABN	(Diecast) ASBD2	ABN□L	(Diecast) ASBD2L	ARN ARNS	ARNL
Page	54	95	54	95	56	56

Function	Cam Switch			
Category	Knob	Key	Enclosed	Spring Return Enclosed
Shape	 	 	 	 
Model	ACSNO ACSSO	ACSNK ACSSK	UCSQO	UCSQM
Page	59	59	59	59

ø30 XN Series Emergency Stop Switches

ø30 mm, 4-contact Emergency Stop Switch. Padlockable and flush bezel are available.

- Padlockable, flush bezel, ø60mm jumbo mushroom, illuminated, LED push-on are available.
- IDEC's original "Safe break action" and reverse energy structure ensure the highest level of safety.
- Safety lock mechanism (IEC 60947-5-5, 6.2)
- Direct opening action mechanism (IEC 60947-5-5, 5.2, IEC60947-5-1, Annex K)
- Short depth behind the panel – only 47.7 mm for 4-contact, illuminated (flush bezel: 60.4 mm, padlockable: 61.4 mm)
- Padlockable can be locked using padlocks when latched (main contact: OFF). The rugged aluminum diecast shroud allows for installing a maximum of 20 padlocks using a hasp (total weight: 1500g maximum).
- Gold-plated silver contacts.
- Red (Munsell 5R4/12) or bright red (Munsell 7.5R4.5/14) colors are available.



Standards

Applicable Standards	Mark	File No. or Organization
UL508 CSA C22.2 No. 14		UL/c-UL File No. E68961 (padlockable only)
IEC60947-5-5 UL991 NFPA79		UL Listing File No. E305148
EN60947-5-5		TÜV SÜD
		EU Low Voltage Directive
GB14048.5		CCC No. 2008010305290010

Contact Ratings

NC main contacts (black)/NO monitor contacts (blue)

Rated Insulation Voltage (Ui)		250V			
Rated Thermal Current (Ith)		5A			
Rated Operating Voltage (Ue)		30V	125V	250V	
Rated Operating Current	Main Contacts	AC 50/60 Hz Resistive Load (AC-12)	–	5A	3A
		Inductive Load (AC-15)	–	3A	1.5A
	DC	Resistive Load (DC-12)	2A	0.4A	0.2A
		Inductive Load (DC-13)	1A	0.22A	0.1A
Monitor Contacts	AC 50/60 Hz	Resistive Load (AC-12)	–	1.2A	0.6A
		Inductive Load (AC-14)	–	0.6A	0.3A
	DC	Resistive Load (DC-12)	2A	0.4A	0.2A
		Inductive Load (DC-13)	1A	0.22A	0.1A
Contact Material		Gold-plated Silver			

- Minimum applicable load: 5V AC/DC, 1 mA (reference value) (May vary depending on the operating conditions and load types.)
- The rated operating currents are measured at resistive/inductive load types specified in IEC 60947-5-1.

Illumination Ratings (LED)

Rated Voltage	Operating Voltage	Rated Current
24V AC/DC	24V AC/DC ±10%	15 mA





Specifications

Applicable Standards	IEC60947-5-1, EN60947-5-1 IEC60947-5-5, EN60947-5-5 JIS C8201-5-1, UL508, UL991, NFPA79 CSA C22.2 No. 14, GB14048.5
Operating Temperature	Non-illuminated: –25 to +60°C (no freezing) Illuminated: –25 to +55°C (no freezing)
Storage Temperature	–45 to +80°C
Operating Humidity	45 to 85% RH (no condensation)
Minimum Force Required for Direct Opening Action	80N
Minimum Operator Stroke Required for Direct Opening Action	4.0 mm
Maximum Operator Stroke	4.5 mm
Contact Resistance	50 mΩ maximum (initial value)
Insulation Resistance	100 MΩ minimum (500V DC megger)
Overvoltage Category	II
Impulse Withstand Voltage	2.5 kV
Pollution Degree	3
Operating Frequency	900 operations/hour
Shock Resistance	Operating extremes: 150 m/s ² Damage limits: 1000 m/s ²
Vibration Resistance	Operating extremes: 10 to 500 Hz, amplitude 0.35 mm, acceleration 50 m/s ² Damage limits: 10 to 500 Hz, amplitude 0.35 mm, acceleration 50 m/s ²
Durability (at 900 operations/h, on-duration 40%)	Mechanical: 250,000 operations minimum Electrical: 100,000 operations minimum 250,000 operations minimum (24V AC/DC, 100 mA)
Degree of Protection	Operator: IP65 (IEC60529) Terminal: IP20 (when XW9Z-VL2MF is installed)
Short-circuit Protection	250V/10A fuse (Type aM, IEC60269-1/IEC60269-2)
Conditional Short-circuit Current	1000A
Terminal Style	M3 screw terminal
Recommended Tightening Torque for Terminal Screw	0.6 to 1.0 N·m
Recommended Tightening Torque for Locking Ring	2.5 N·m
Applicable Wire Size	0.75 to 1.25 mm ² (AWG18 to 16)
Total Weight of a Hasp and Padlocks	1500g maximum (padlockable)
Reinforced Insulation (IEC 60664-1)	Between live part and metal bezel (flush bezel, padlockable)
Weight	83g (XN1E-LV404Q4MR) 93g (XN1E-BV504MR) 89g (XN5E-LV404Q4MR) 120g (XN4E-LL404Q4MR)

XN Series Emergency Stop Switches ø30



Plastic Bezel

Non-illuminated Pushlock Pull/Turn Reset (Solder Terminal)

Shape	NC Main Contact	NO Monitor Contact	Part No.		① Operator Color Code
			IP20 Fingersafe Terminal	w/Terminal Cover	
 	1NC	—	XN1E-BV401MF ①	XN1E-BV401M ①	R: Red RH: Bright red
	2NC	—	XN1E-BV402MF ①	XN1E-BV402M ①	
	3NC	—	XN1E-BV403MF ①	XN1E-BV403M ①	
	4NC	—	XN1E-BV404MF ①	XN1E-BV404M ①	
	1NC	1NO	XN1E-BV411MF ①	XN1E-BV411M ①	
	2NC	1NO	XN1E-BV412MF ①	XN1E-BV412M ①	
	3NC	1NO	XN1E-BV413MF ①	XN1E-BV413M ①	
	2NC	2NO	XN1E-BV422MF ①	XN1E-BV422M ①	
 	1NC	—	XN1E-BV501MF ①	XN1E-BV501M ①	
	2NC	—	XN1E-BV502MF ①	XN1E-BV502M ①	
	3NC	—	XN1E-BV503MF ①	XN1E-BV503M ①	
	4NC	—	XN1E-BV504MF ①	XN1E-BV504M ①	
	1NC	1NO	XN1E-BV511MF ①	XN1E-BV511M ①	
	2NC	1NO	XN1E-BV512MF ①	XN1E-BV512M ①	
	3NC	1NO	XN1E-BV513MF ①	XN1E-BV513M ①	
	2NC	2NO	XN1E-BV522MF ①	XN1E-BV522M ①	



- Specify a color code in place of ① in the Part No.
- Only solid wires can be used on the IP20 fingersafe terminal switches.

Illuminated Pushlock Pull/Turn Reset (Solder Terminal)

Shape	Illumination	Rated Voltage	NC Main Contact	NO Monitor Contact	Part No.		Operator Color
					IP20 Fingersafe Terminal	w/Terminal Cover	
 	LED	24V AC/DC	1NC	—	XN1E-LV401Q4MFR	XN1E-LV401Q4MR	Red only
			2NC	—	XN1E-LV402Q4MFR	XN1E-LV402Q4MR	
			3NC	—	XN1E-LV403Q4MFR	XN1E-LV403Q4MR	
			4NC	—	XN1E-LV404Q4MFR	XN1E-LV404Q4MR	
			1NC	1NO	XN1E-LV411Q4MFR	XN1E-LV411Q4MR	
			2NC	1NO	XN1E-LV412Q4MFR	XN1E-LV412Q4MR	
			3NC	1NO	XN1E-LV413Q4MFR	XN1E-LV413Q4MR	
			2NC	2NO	XN1E-LV422Q4MFR	XN1E-LV422Q4MR	

- Only solid wires can be used on the IP20 fingersafe terminal switches.

Illuminated Push-ON Pushlock Pull/Turn Reset (Solder Terminal)



Shape	Illumination	Rated Voltage	NC Main Contact	NO Monitor Contact	Part No.		Operator Color
					IP20 Fingersafe Terminal	w/Terminal Cover	
 	LED	24V AC/DC	2NC	—	XN1E-TV402Q4MFR	XN1E-TV402Q4MR	Red only
			3NC	—	XN1E-TV403Q4MFR	XN1E-TV403Q4MR	
			2NC	1NO	XN1E-TV412Q4MFR	XN1E-TV412Q4MR	

- Push-ON is illuminated when the operator is latched, and turns off when reset.
- Only solid wires can be used on the IP20 fingersafe terminal switches.

ø30 XN Series Emergency Stop Switches



Flush Bezel

Non-illuminated Pushlock Pull/Turn Reset (Solder Terminal)

Shape	NC Main Contact	NO Monitor Contact	Part No.		Operator Color Code
			IP20 Fingersafe Terminal	w/Terminal Cover	
 	1NC	—	XN5E-BV401MF ①	XN5E-BV401M ①	R: Red RH: Bright red
	2NC	—	XN5E-BV402MF ①	XN5E-BV402M ①	
	3NC	—	XN5E-BV403MF ①	XN5E-BV403M ①	
	4NC	—	XN5E-BV404MF ①	XN5E-BV404M ①	
	1NC	1NO	XN5E-BV411MF ①	XN5E-BV411M ①	
	2NC	1NO	XN5E-BV412MF ①	XN5E-BV412M ①	
	3NC	1NO	XN5E-BV413MF ①	XN5E-BV413M ①	
	2NC	2NO	XN5E-BV422MF ①	XN5E-BV422M ①	



- Specify a color code in place of ① in the Part No.
- Only solid wires can be used on the IP20 fingersafe terminal switches.

Illuminated Pushlock Pull/Turn Reset (Solder Terminal)

Shape	Illumination	Rated Voltage	NC Main Contact	NO Monitor Contact	Part No.		Operator Color
					IP20 Fingersafe Terminal	w/Terminal Cover	
 	LED	24V AC/DC	1NC	—	XN5E-LV401Q4MFR	XN5E-LV401Q4MR	Red only
			2NC	—	XN5E-LV402Q4MFR	XN5E-LV402Q4MR	
			3NC	—	XN5E-LV403Q4MFR	XN5E-LV403Q4MR	
			4NC	—	XN5E-LV404Q4MFR	XN5E-LV404Q4MR	
			1NC	1NO	XN5E-LV411Q4MFR	XN5E-LV411Q4MR	
			2NC	1NO	XN5E-LV412Q4MFR	XN5E-LV412Q4MR	
			3NC	1NO	XN5E-LV413Q4MFR	XN5E-LV413Q4MR	
			2NC	2NO	XN5E-LV422Q4MFR	XN5E-LV422Q4MR	

- Only solid wires can be used on the IP20 fingersafe terminal switches.

Illuminated Push-ON Pushlock Pull/Turn Reset (Solder Terminal)



Shape	Illumination	Rated Voltage	NC Main Contact	NO Monitor Contact	Part No.		Operator Color
					IP20 Fingersafe Terminal	w/Terminal Cover	
 	LED	24V AC/DC	2NC	—	XN5E-TV402Q4MFR	XN5E-TV402Q4MR	Red only
			3NC	—	XN5E-TV403Q4MFR	XN5E-TV403Q4MR	
			2NC	1NO	XN5E-TV412Q4MFR	XN5E-TV412Q4MR	

- Push-ON is illuminated when the operator is latched, and turns off when reset.
- Only solid wires can be used on the IP20 fingersafe terminal switches.

XN Series Emergency Stop Switches ø30



Padlockable

Non-illuminated Pushlock Pull/Turn Reset (Padlockable)

Shape	NC Main Contact	NO Monitor Contact	Part No.		Operator Color
			IP20 Fingersafe Terminal	w/Terminal Cover	
 	1NC	—	XN4E-BL401MFRH	XN4E-BL401MRH	Bright red only
	2NC	—	XN4E-BL402MFRH	XN4E-BL402MRH	
	3NC	—	XN4E-BL403MFRH	XN4E-BL403MRH	
	4NC	—	XN4E-BL404MFRH	XN4E-BL404MRH	
	1NC	1NO	XN4E-BL411MFRH	XN4E-BL411MRH	
	2NC	1NO	XN4E-BL412MFRH	XN4E-BL412MRH	
	3NC	1NO	XN4E-BL413MFRH	XN4E-BL413MRH	
	2NC	2NO	XN4E-BL422MFRH	XN4E-BL422MRH	



- Only solid wires can be used on the IP20 fingersafe terminal switches.
- Padlocks and hasps are not supplied with the emergency stop switches and must be ordered separately. See page 12.

Illuminated Pushlock Pull/Turn Reset (Padlockable)

Shape	Illumination	Rated Voltage	NC Main Contact	NO Monitor Contact	Part No.		Operator Color
					IP20 Fingersafe Terminal	w/Terminal Cover	
 	LED	24V AC/DC	1NC	—	XN4E-LL401Q4MFR	XN4E-LL401Q4MR	Red only
			2NC	—	XN4E-LL402Q4MFR	XN4E-LL402Q4MR	
			3NC	—	XN4E-LL403Q4MFR	XN4E-LL403Q4MR	
			4NC	—	XN4E-LL404Q4MFR	XN4E-LL404Q4MR	
			1NC	1NO	XN4E-LL411Q4MFR	XN4E-LL411Q4MR	
			2NC	1NO	XN4E-LL412Q4MFR	XN4E-LL412Q4MR	
			3NC	1NO	XN4E-LL413Q4MFR	XN4E-LL413Q4MR	
			2NC	2NO	XN4E-LL422Q4MFR	XN4E-LL422Q4MR	

- Only solid wires can be used on the IP20 fingersafe terminal switches.
- Padlocks and hasps are not supplied with the emergency stop switches and must be ordered separately. See page 12.

LED Push-ON Pushlock Pull/Turn Reset (Padlockable)

Shape	Illumination	Rated Voltage	NC Main Contact	NO Monitor Contact	Part No.		Operator Color
					IP20 Fingersafe Terminal	w/Terminal Cover	
 	LED	24V AC/DC	2NC	—	XN4E-TL402Q4MFR	XN4E-TL402Q4MR	Red only
			3NC	—	XN4E-TL403Q4MFR	XN4E-TL403Q4MR	
			2NC	1NO	XN4E-TL412Q4MFR	XN4E-TL412Q4MR	

- Push-ON is illuminated when the operator is latched, and turns off when reset.
- Only solid wires can be used on the IP20 fingersafe terminal switches.
- Padlocks and hasps are not supplied with the emergency stop switches and must be ordered separately. See page 12.

ø30 XN Series Emergency Stop Switches

Dimensions

Plastic Bezel
Non-illuminated
IP20 Fingersafe

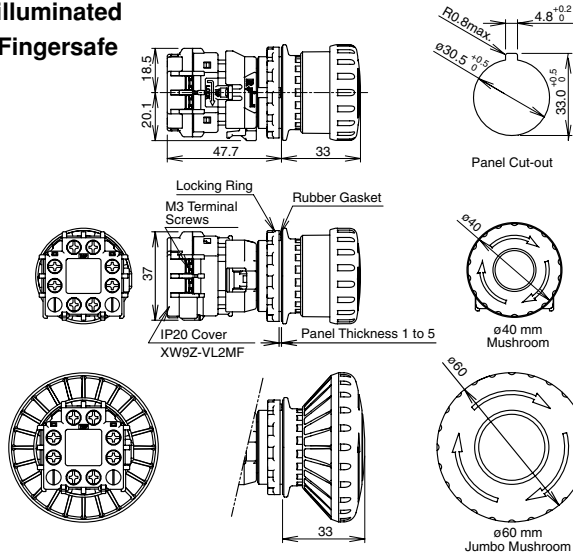

w/Terminal Cover

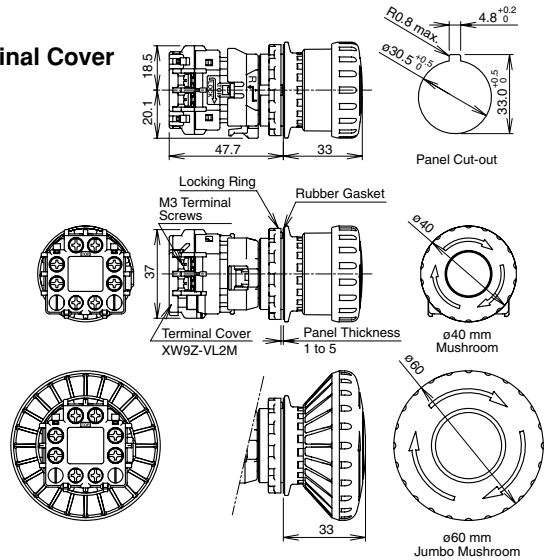

Illuminated/Push-ON

IP20 Fingersafe

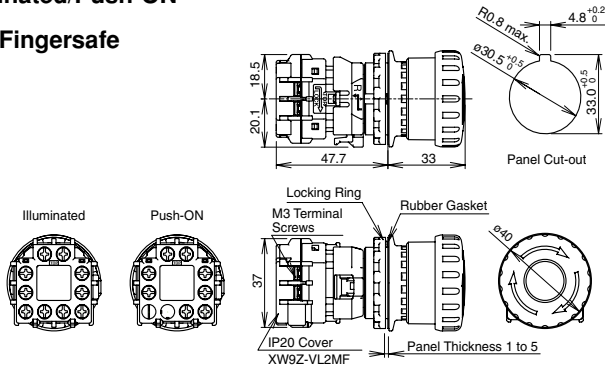

w/Terminal Cover

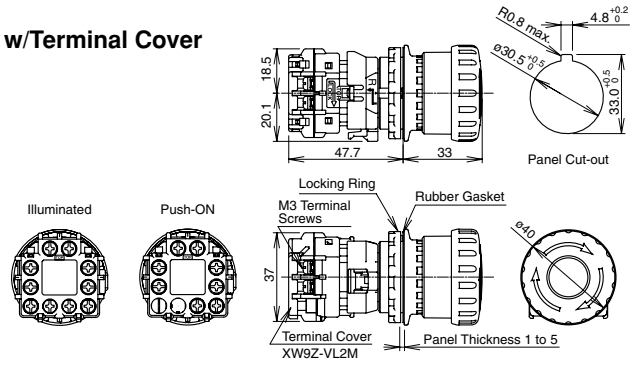

Flush Bezel

Non-Illuminated

IP20 Fingersafe

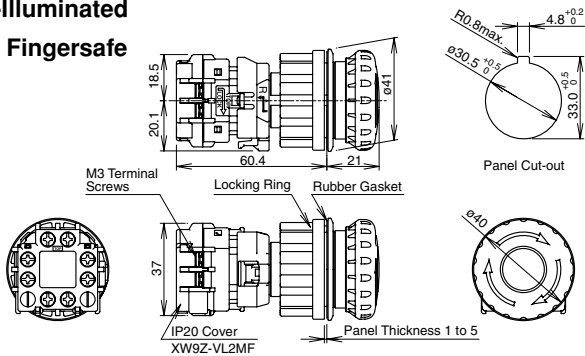

w/Terminal Cover

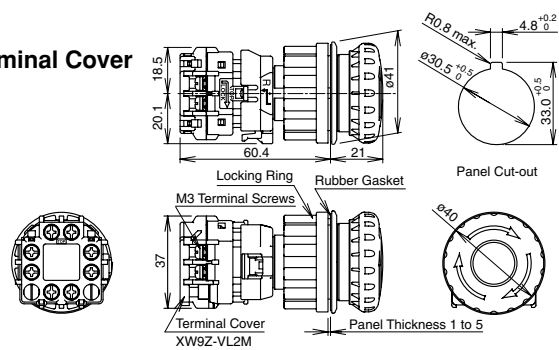

Illuminated/Push-ON

IP20 Fingersafe

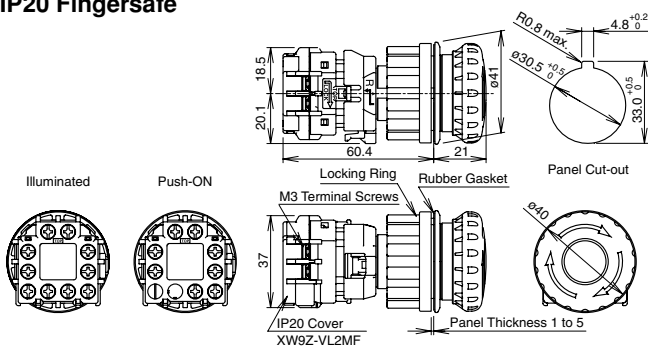

w/Terminal Cover

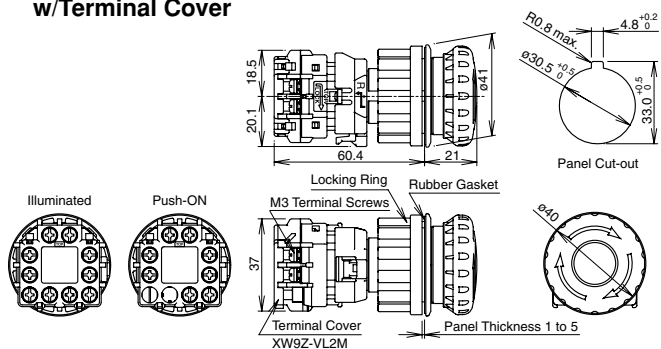

All dimensions in mm.

XN Series Emergency Stop Switches $\phi 30$

Dimensions

Padlockable
Non-illuminated
IP20 Fingersafe

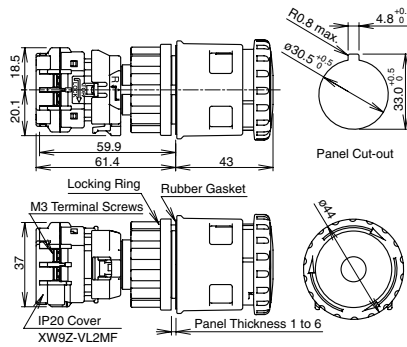

w/Terminal Cover

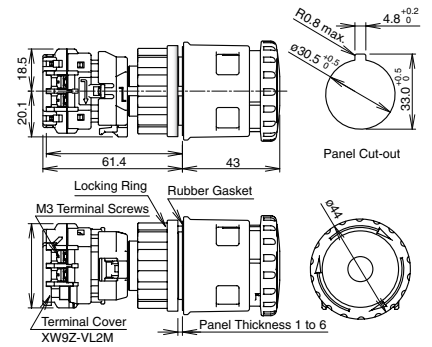

Illuminated/ Push-ON

IP20 Fingersafe

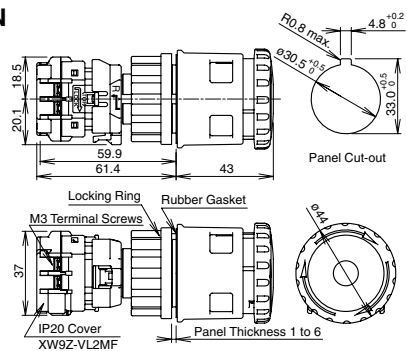
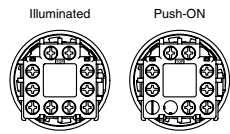

w/Terminal Cover

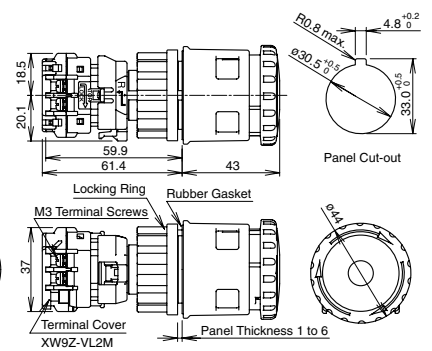
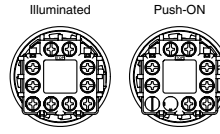

Mounting Hole Layout

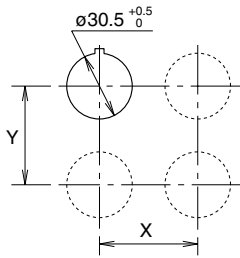

	X	Y
Plastic Bezel	70 mm minimum	
Flush Bezel	70 mm minimum	

- The values shown above are the minimum dimensions for mounting with other $\phi 30$ mm pushbuttons. For other control units of different sizes and styles, determine the values according to the dimensions, operation, and wiring convenience.
- For padlockable, determine the values according to the size and number of padlocks and hasp.

LED Unit Internal Circuit

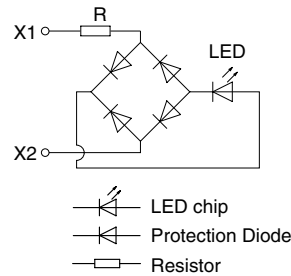

Terminal Arrangement (Bottom View)

Non-illuminated

NC main contacts (black) only

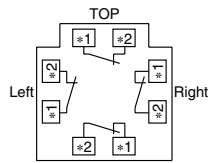

- 1NC: Terminals on right
- 2NC: Terminals on right and left
- 3NC: Terminals on right, left, and top

With 1NO monitor contact (blue)

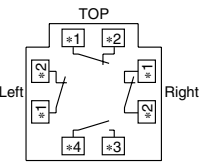

- 1NC: Terminals on top
- 2NC: Terminals on right and left

With 2NO monitor contacts (blue)

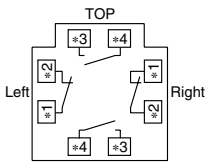

Illuminated

NC main contacts (black) only

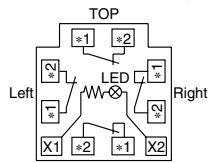

- 1NC: Terminals on right
- 2NC: Terminals on right and left
- 3NC: Terminals on right, left, and top

With 1NO monitor contact (blue)

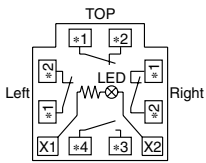

- 1NC: Terminals on top
- 2NC: Terminals on right and left

With 2NO monitor contacts (blue)

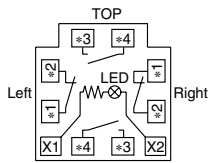

Push-ON

NC main contacts (black) only

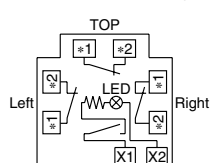

- 2NC: Terminals on right and left
- 3NC: Terminals on right, left, and top

With 1NO monitor contact (blue)

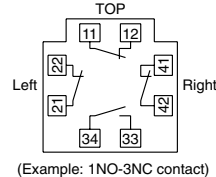
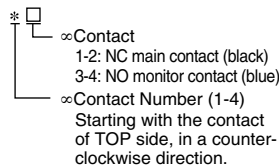
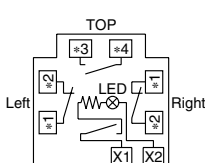

(Example: 1NO-3NC contact)

Applicable Crimping Terminal

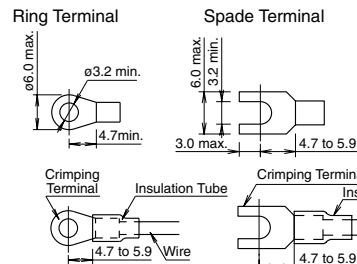

Solid Wire

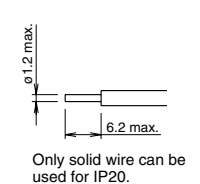





- Be sure to install an insulating tube on the crimping terminal.

All dimensions in mm.

ø30 XN Series Emergency Stop Switches

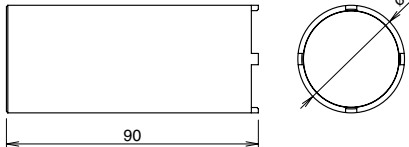
Accessories and Replacement Parts

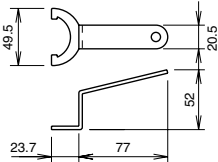
Name & Shape	Material	Part No.	Ordering No.	Package Quantity	Remarks
	PPE	XW9Z-VL2M	XW9Z-VL2MPN02	2	<ul style="list-style-type: none"> Black Used for screw terminals. Attached to IP20 protection cover units.
	Polyamide	XW9Z-VL2MF	XW9Z-VL2MFPN02	2	<ul style="list-style-type: none"> Black Used to change terminal cover to IP20 fingersafe terminal. Only solid wires can be used. Once installed, IP20 terminal cover cannot be removed.
	Brass	XN9Z-T1	XN9Z-T1	1	<ul style="list-style-type: none"> Used to tighten the locking ring when installing the XN emergency stop switch onto a panel. 
	Steel Trivalent chromate plating	TWST-T1	TWST-T1	1	<ul style="list-style-type: none"> Used to tighten the locking ring when installing the XN emergency stop switch onto a panel. 

- The XN series emergency stop switches are supplied with either terminal cover or IP20 fingersafe terminal cover.
- Padlocks and hasps are not supplied and must be ordered separately.

Nameplates (for ø30 Emergency Stop Switches)

Description & Shape	Legend	Part No.	Package Quantity	Dimensions (mm)
	(blank)	HNAV-0	1	Polyamide Mounting panel thickness XN4E-□L4: 1.0 to 4.5 mm XN□E-□V4: 1.0 to 3.5 mm 
	EMERGENCY STOP	HNAV-27		

Plate color: Yellow (Munsell 2.5Y 8/10 or equivalent),
Legend: Black

Padlock and Hasp

Padlocks and hasps of the following specifications can be used with padlockable emergency stop switches.

Padlock Size

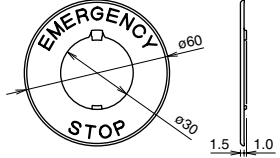
A	B	C	D
7 mm maximum	19 mm minimum	39 mm minimum	15 mm minimum (Note)

Note: When the padlock is installed from the side of the bezel, dimension D requires a minimum of 6 mm. When the padlock is installed from the front of the button, dimension D requires a minimum of 15 mm.

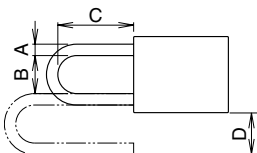

Recommended Hasps

Manufacturer	Part No.
PANDUIT CORP.	PSL-HD3 PSL-1A
Master Lock	420 421

Use only padlocks or hasps that satisfy the specifications shown on the left. The maximum total weight for padlocks and hasps is 1500g.

Make sure that the total weight does not exceed 1500g, otherwise the XN emergency stop switch may be damaged.

Make sure that locking and unlocking of the padlock and hasp do not interfere with other devices.

Padlocks and hasps are available from the following manufacturers.

Manufacturer	URL
PANDUIT CORP.	http://www.panduit.com/
Master Lock® Company LLC	http://www.masterlock.com/

Operating Instructions

Removing the Contact Block

First unlock the operator button. Grab the yellow bayonet ring ① and pull back the bayonet ring until the latch pin clicks ②, then turn the contact block counterclockwise and pull out ③.

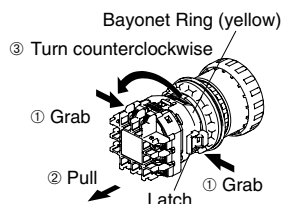

Notes for removing the contact block

1. Do not attempt to remove the contact block while the operator is latched, otherwise the switch may be damaged.
2. When the contact block is removed, the monitor contact (NO contact) is closed.
3. While removing the contact block, do not use excessive force, otherwise the switch may be damaged.
4. An LED lamp is built into the contact block for illuminated pushbuttons. When removing the contact block, pull the contact block straight to prevent damage to the LED lamp. If excessive force is used, the LED lamp may be damaged and fail to light.

Panel Mounting

Remove the locking ring from the operator and check that the rubber gasket is in place. Insert the operator from panel front into the panel hole. Face the side without thread on the operator with TOP marking upward, and tighten the locking ring using ring wrench XN9Z-T1 or TWST-T1 to a torque of 2.5 N·m maximum.

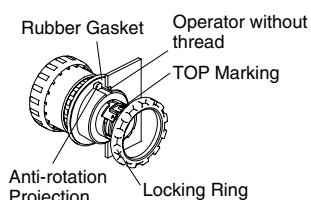

When using a nameplate

When using a nameplate HNAV-□, break the projection from the nameplate using pliers.



Installing the Contact Block

First unlock the operator button. Align the small ▼ marking on the edge of the operator with the small ▲ marking on the yellow bayonet ring. Hold the contact block, not the bayonet ring. Press the contact block onto the operator and turn the contact block clockwise until the bayonet ring clicks.

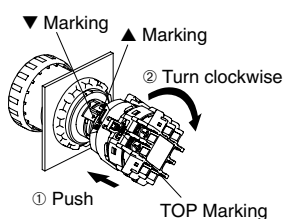

Notes for installing the contact block

1. Do not attempt to install the contact block when the operator is latched, otherwise the switch may be damaged.
2. Make sure that the bayonet ring is in the locked position.

Installing & Removing Terminal Covers

XW9Z-VL2M

To install the terminal cover, align the TOP marking on the terminal cover with the TOP marking on the contact block. Place the two projections on the bottom side of the contact block into the slots in the terminal cover. Press the terminal cover toward the contact block.

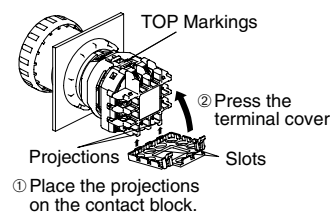

To remove the terminal cover, pull out the two latches on the top side of the terminal cover. Do not exert excessive force to the latches, otherwise the latches may break.

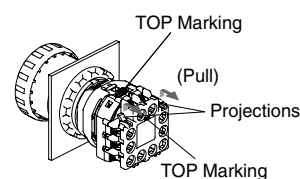

IP20 Fingersafe Terminal Cover XW9Z-VL2MF

To install the IP20 fingersafe terminal cover, align the TOP marking on the cover with the TOP marking on the contact block, and press the cover toward the contact block.

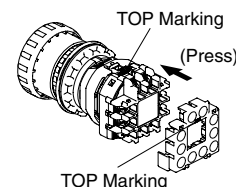

Notes:

1. Once installed, the XW9Z-VL2MF cannot be removed.
2. With the XW9Z-VL2MF installed, crimping terminals cannot be used. Use solid wires.
3. The XW9Z-VL2MF cannot be installed after wiring.
4. Make sure that the XW9Z-VL2MF is securely installed. IP20 cannot be achieved when installed loosely, and electric shocks may occur.

Notes for Operation

When using the XN emergency stop switches in safety-related part of a control system, observe safety standards and regulations of the relevant country or region. Also be sure to perform a risk assessment before operation.

Wiring

Tighten the M3 terminal screws to a torque of 0.6 to 1.0 N·m.

Contact Bounce

When the button is reset by pulling or turning, the NC main contacts will bounce. When pressing the button, the NO monitor contacts will bounce. When designing a control circuit, take the contact bounce time into consideration (reference value: 20 ms).

LED Illuminated Switches

An LED lamp is built into the contact block and cannot be replaced.

Handling

Do not expose the switch to excessive shocks and vibrations, for example by operating the switch with tools. Otherwise the switch may be deformed or damaged, causing malfunction or operation failure.

ø30 HN Series Emergency Stop Switches

Emergency Stop Switches (Unibody) Specifications

Standards

Applicable Standards	Mark	File No. or Organization
UL508 CSA C22.2 No. 14		UL Listing File No. E55996
EN60947-5-5		DEMKO approved
		EU Low Voltage Directive
GB14048.5		CCC No. 2004010305132910

Contact Ratings

Rated Insulation Voltage (Ui)		250V			
Rated Thermal Current (Ith)		10A			
Rated Operational Voltage (Ue)		24V	110V	220V	
Rated Operational Current	AC 50/60 Hz	Resistive Load (AC-12)	6A	3A	3A
		Inductive Load (AC-15)	6A	3A	3A
	DC	Resistive Load (DC-12)	6A	2A	1A
		Inductive Load (DC-13)	1.5A	0.3A	0.15A

Note: The operational current represents the classification by making and breaking currents (IEC 60947-5-1).
Minimum applicable load (reference value): 3V AC/DC, 5 mA (Applicable range may vary with operating conditions and load types.)

LED Lamp Ratings

Rated Operating Voltage of Unit	LED Lamp		
	Part No.	Rated Voltage	Rated Current
24V AC/DC	LSTD-2R	24V AC/DC ±10%	10 mA

Incandescent Lamp Ratings

Unit Rated Operating Voltage	Incandescent Lamp	
	Part No.	Wattage
24V AC/DC	LS-3	1W (30V)

Specifications

Operating Temperature	-25 to +60°C (no freezing) Illuminated units: -25 to +55°C
Storage Temperature	-40 to +80°C
Operating Humidity	45 to 85% RH (no condensation)
Operating Force	50N
Minimum Force Required for Direct Opening Action	5.5 mm
Maximum Operator Stroke	10 mm
Contact Resistance	50 mΩ maximum (initial value)
Insulation Resistance	100 MΩ minimum (500V DC megger)
Dielectric Strength	Between live and dead metal parts Contacts: 2,500V AC, 1 minute Illuminated parts: 1,000V AC, 1 minute
Vibration Resistance	Damage limits: 30 Hz, amplitude 1.5 mm Operating extremes: 5 to 55 Hz, amplitude 0.5 mm
Shock Resistance	Damage limits: 1,000 m/s ² Operating extremes: 100 m/s ²
Operating Frequency	900 operations/h
Life	Mechanical: 250,000 operations minimum Electrical: 100,000 operations minimum
Degree of Protection	IP65
Terminal Style	M3.5 screw
Weight (approx.)	58g (HN1E-BV402R) 65g (HN1E-LV402Q4R)

Pushlock Turn Reset Switches (Unibody)

Shape	Contact	Part No.	Button Color
 	1NO-1NC	HN1E-BV411R	Red only
	2NC	HN1E-BV402R	

- When pressed, the button is held depressed. The button is released by turning clockwise.
- Terminal cover HW-VL7 is supplied with the switch.

Illuminated Pushlock Turn Reset Switches (Unibody)

Shape	Lamp	Contact	Part No.	Lens Color
 	Without Lamp	1NO-1NC	HN1E-LV411Q0R	Red only
		2NC	HN1E-LV402Q0R	

- When pressed, the button is held depressed. The button is released by turning clockwise.
- Terminal cover HW-VL7 is supplied with the switch.

Maintenance Parts

Name	Part No.	Ordering No.	Package Quantity
Terminal Cover for HW1E	HW-VL7	HW-VL7PN10	10

HN Series Emergency Stop Switches $\phi 30$

Dimensions

HN1E-BV4

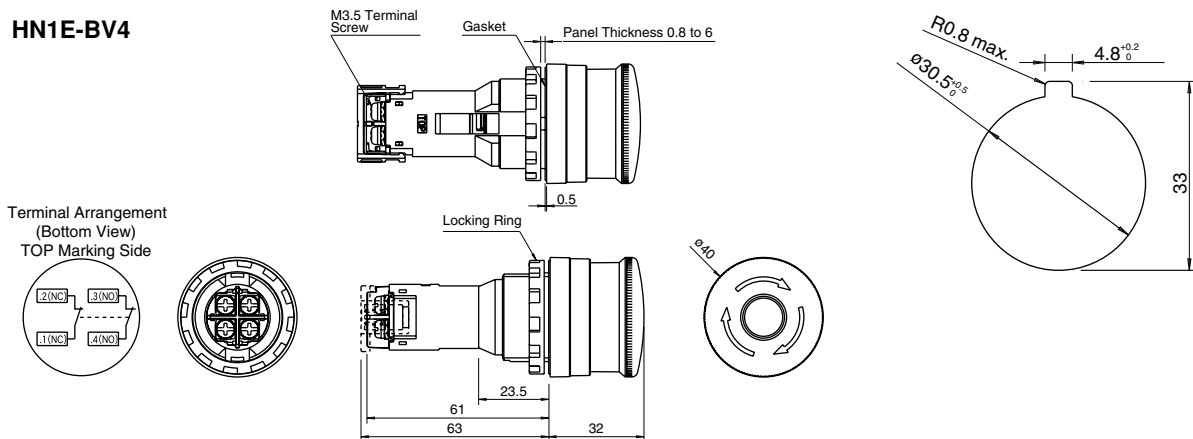

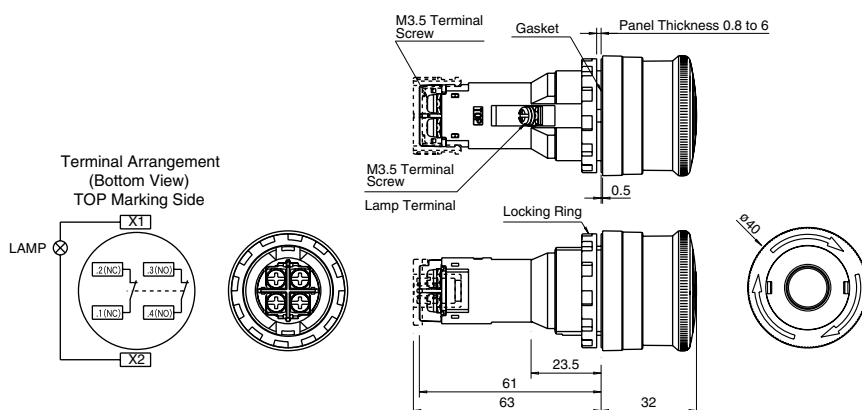

HN1E-LV4



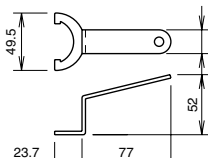

All dimensions in mm.

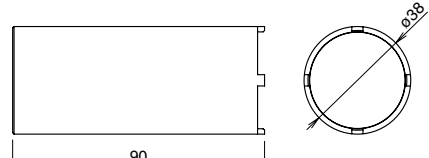
Accessory

Shape	Material	Part No.	Package Quantity	Remarks
	Metal	TWST-T1	1	Used for tightening the locking nut. Tighten the locking nut to a torque of 2.0 to 2.5 N·m. 
	Brass	XN9Z-T1	1	• Used to tighten the locking ring when installing the XN emergency stop switch onto a panel. 

Nameplates (for $\phi 30$ Emergency Stop Switches)

Shape	Part No.	Legend	Package Quantity	Remarks
	HNAV-0	(blank)	1	Background: Yellow Legend: Black Applicable panel thickness: 0.8 to 4.5 mm Material: Polyamide Legend "EMERGENCY STOP" is indicated outside a $\phi 44$ mm circle. 
	HNAV-27	EMERGENCY STOP		

ø30 Series Control Units

Heavy duty control units offer both variety and reliability Endures harsh environments

- Degree of protection: IP65
- UL, CSA approved, and EN compliant.

Applicable Standards	Mark	File No. or Organization
UL 508		UL Listing File No. E68961
CSA C22.2 No.14		CSA File No. LR21451
EN60947-5-1		EU Low Voltage Directive
GB14048.5		CCC No. 200501030514658



Specifications and Ratings

Contact Ratings

Pushbuttons	Contact Block	BS/BST (ø30 series)
Illuminated Pushbuttons	Rated Insulation Voltage	600V
Selector Switches	Rated Continuous Current	10A
Illuminated Selector Switches	Contact Ratings by Utilization Category	AC-15 (A600)
Selector Pushbuttons	IEC 60947-5-1	DC-13 (P600)

Characteristics

Contact Ratings by Utilization Category

Operational Voltage			24V	48V	50V	110V	220V	440V
Operational Current	AC 50/60 Hz	AC-12 Control of resistive loads and solid state loads	10A	—	10A	10A	6A	2A
		AC-15 Control of electromagnetic loads (> 72 VA)	10A	—	7A	5A	3A	1A
	DC	DC-12 Control of resistive loads and solid state loads	10A	5A	—	2.2A	1.1A	—
		DC-13 Control of electromagnets	5A	2A	—	1.1A	0.6A	—

Note: The operational current represents the classification by making and breaking currents (IEC 60947-5-1).
Minimum applicable load: 3V AC/DC, 5 mA (applicable range may vary with operating conditions and load types)
For mono-levers and cam switches, see pages 55 and 58.

BS (BST) Contact Block

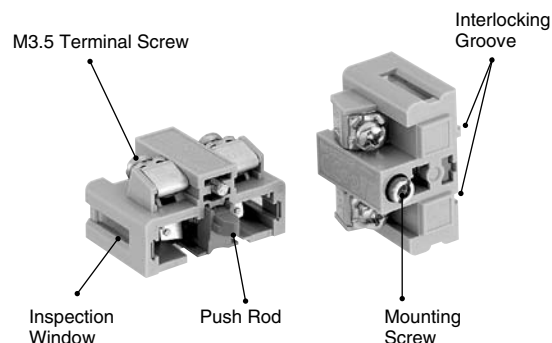

Contact Blocks

Contact		Single-pole Contact Block			
Part No.	BS	BS010E	BS001E	BS010SE	BS001SE
	BST	BST010	BST001	BST010S	BST001S
Push Rod		Green	Red	Black	White

BST contact blocks are used for the following control units and are not interchangeable with BS contact blocks.
(The BS housing is dark gray and the BST housing is light gray.)

- Pushlock turn reset and push turn lock switches
- LED illuminated pushbuttons
- LED/incandescent illuminated selector switches
- All models of diecast zinc housing control units

- Durable nylon 66 housing has a high resistance against alkalis.
- Silver contacts. Gold contact (gold-plated silver) also available.
- Up to four blocks in two layers can be mounted onto each operator.

LED Illuminated Unit Specifications

Unit	Color Code ②	Input	Operating Voltage	LED Lamp		
				Lamp Base	Part No.	Voltage
Pilot Light Illuminated Pushbutton Illuminated Selector Switch	A: amber G: green PW: pure white R: red S: blue W: white Y: yellow	Full Voltage	6V AC/DC	BA9S/13	LSTD-6 ②	6V AC/DC ±10%
			12V AC/DC		LSTD-1 ②	12V AC/DC ±10%
			24V AC/DC		LSTD-2 ②	24V AC/DC ±10%
			6V AC/DC	E12/15	LETD-6 ②	6V AC/DC ±10%
			12V AC/DC		LETD-8 ②	12V AC/DC ±10%
			24V AC/DC		LETD-2 ②	24V AC/DC ±10%
		Transformer	100/110V AC 115V AC 120V AC 200/220V AC 230V AC 240V AC 380V AC 400/440V AC (50/60 Hz)	BA9S/13	LSTD-6 ②	6V AC/DC ±10%
			E12/15	LETD-6 ②		
		DC-DC Converter	110V DC	BA9S/13	LSTD-6 ②	6V AC/DC ±10%
				E12/15	LETD-6 ②	

Note: A pure white LED lamp is used for yellow illumination.

Incandescent Illuminated Unit Specifications

Unit	Color Code ②	Input	Operating Voltage	Incandescent Lamp		
				Lamp Base	Part No.	Rating
Pilot Light Illuminated Pushbutton Illuminated Selector Switch	A: amber G: green O: orange R: red S: blue W: white	Full Voltage	6V AC/DC	BA9S/13	LS-6	1W (6.3V)
			12V AC/DC		LS-8	1W (18V)
			24V AC/DC		LS-3	1W (30V)
			6V AC/DC	E12/15	LE-6	2W (6.3V)
			12V AC/DC		LE-8	2W (18V)
			24V AC/DC		LE-3	12W (30V)
		Transformer	100/110V AC 115V AC 120V AC 200/220V AC 230V AC 240V AC 380V AC 400/440V AC 480V AC (50/60 Hz)	BA9S/13	LS-6	1W (6.3V)
			E12/15	LE-8	2W (18V)	

LED Lamp Ratings (LSTD)

Part No.	LSTD-6 ②		LSTD-1 ②	LSTD-2 ②
Lamp Base	BA9S/13			
Rated Voltage	6V AC/DC		12V AC/DC	24V AC/DC
Voltage Range	6V AC/DC ±10%		12V AC/DC ±10%	24V AC/DC ±10%
Current Draw	AC	8 mA	11 mA	11 mA
	DC	A, R, W: 7 mA G, PW, S: 5.5 mA	10 mA	10 mA
Color Code ②	A (amber), G (green), PW (pure white), R (red), S (blue), W (white)			
Lamp Base Color	Same as illumination color			
Voltage Marking	Die stamped on the base			
Life (reference value)	Approx. 50,000 hours (The luminance is reduced to 50% the initial intensity when used on complete DC.)			
Internal Circuit				

ø30 ø30 Series Control Units

LED Lamp Ratings (LETD)

Part No.	LETD-6②		LETD-8②	LETD-2②
Lamp Base	E12/15			
Rated Voltage	6V AC/DC		12V AC/DC	24V AC/DC
Voltage Range	6V AC/DC ±10%		12V AC/DC ±10%	24V AC/DC ±10%
Current Draw	A, R, W, Y	G, S	A, R, W, Y	G, S
	AC	17 mA	8 mA	7 mA
DC	14 mA	5.5 mA	6.5 mA	10 mA
Color Code ②	A (amber), G (green), R (red), S (blue), W (white), Y (yellow)			
Lamp Base Color	Same as illumination color			
Voltage Marking	Die stamped on the base			
Life (reference value)	Approx. 50,000 hours (The luminance is reduced to 50% the initial intensity when used on complete DC.)			
Internal Circuit	A, R, W	Y	A, R, W	Y
	<p style="text-align: center;">G, S</p>			

Incandescent Lamp Ratings (LS)

Part No.	LS-6	LS-8	LS-2	LS-3
Lamp Base	BA9S/13			
Rated Voltage	6V AC/DC	12V AC/DC	18V AC/DC	24V AC/DC
Wattage	1W (6.3V)	1W (18V)	1W (24V)	1W (30V)
Voltage Marking	Die stamped on the base			
Life (reference value)	Approx. 1,000 hours minimum (mean value when used on the rated voltage)			

Incandescent Lamp Ratings (LE)

Part No.	LE-6	LE-8	LE-2	LE-3
Lamp Base	E12/15			
Rated Voltage	6V AC/DC	12V AC/DC	18V AC/DC	24V AC/DC
Wattage	2W (6.3V)	2W (18V)	2W (24V)	2W (30V)
Voltage Marking	Die stamped on the base			
Life (reference value)	Approx. 1,000 hours minimum (mean value when used on the rated voltage)			

Specifications

Operating Temperature	-25 to +50°C (no freezing)	
Storage Temperature	-40 to +80°C (no freezing)	
Operating Humidity	45 to 85% RH (no condensation)	
Contact Resistance	50 mΩ maximum (initial value)	
Insulation Resistance	100 MΩ minimum (500V DC megger)	
Dielectric Strength	Between live and dead metal parts: 2,500V AC, 1 minute (Full voltage and pilot lights: 2,000V AC, 1 minute)	
Vibration Resistance	Operating extremes: 5 to 55 Hz, amplitude 0.5 mm	
Shock Resistance	Damage limits: 1,000 m/s ² Operating extremes: 100 m/s ²	
Mechanical Life (minimum operations)	Pushbuttons	
	Momentary:	5,000,000
	Maintained:	500,000
	Illuminated pushbuttons	
	Momentary:	2,500,000
	Maintained:	500,000
	Selector switches:	500,000
	Key selector switches:	500,000
	Illuminated selector switches:	500,000
	Selector pushbuttons:	250,000
Electrical Life (minimum operations)	Mono-lever switches:	500,000
	(Interlocking):	250,000
	Pushlock turn reset	500,000
	Mushroom push-pull switch	
	Two contact blocks:	500,000
	Four contact blocks:	200,000
	Pushbuttons:	500,000 *1
	Illuminated pushbuttons:	500,000 *1
	Selector switches:	500,000 *2
	Key selector switches:	500,000 *2
Illuminated selector switches:	500,000 *2	
Selector pushbuttons:	250,000 *2	
Mono-lever switches:	500,000 *3	
(Interlocking):	250,000 *3	
*1 Switching frequency 1,800 operations/h, duty ratio 40% *4		
*2 Switching frequency 1,200 operations/h, duty ratio 40%		
*3 Switching frequency 900 operations/h, duty ratio 40%		
*4 Switching frequency 900 operations/h for square twin or twin maintained		

Degree of Protection

Part No.	Unit	NEMA ICS 6-110	IEC 60529
A****	Pushbuttons, pilot lights, illuminated pushbuttons, selector switches, selector pushbuttons, mono-lever switches, and cam switches (ACSNO/ACSSO)	Type 1, 2, 3, 3R, (3S), 4, 5, 12,13	IP65
	Illuminated selector switches, key pushbuttons, key reset pushbuttons, key cam switches, and key selector switches	Type 1, 2, 3, 3R, 5, 12, 13	IP54
U****	Square pushbuttons, square pilot lights, and cam switches (UC)	Type 1, 2	IP40

Note: (3S) of NEMA ICS 6-110 applies to the pilot lights with round lens.

Mounting Hole Layout

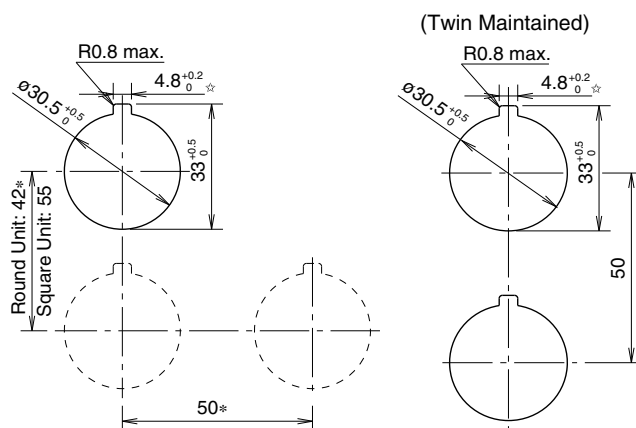

*The minimum mounting centers are applicable to switches with one layer of contact blocks (two contact blocks). When two layers of contact blocks (four contact blocks) are mounted, determine the minimum mounting centers in consideration of convenience for wiring.

- Mushroom with shroud: 50 mm minimum
- Jumbo mushroom: 67 mm minimum
- Jumbo mushroom with shroud: 76 mm minimum
- Square twin: 55 mm minimum
- Selector switch with lever: 50 mm minimum

☆ The 4.8 mm recess is for preventing rotation and is not necessary when the nameplate or anti-rotation ring is not used.

Note: For mounting hole layout of pushbuttons, mono-lever switches, and cam switches, see each section.

ø30 ø30 Series Control Units (Ordering Information)

Ordering Information

Standard Units

- Specify an operator or lens color code in the Part No.
- Black, green, and red buttons are included with flush pushbuttons.
- Terminal covers, nameplates, and accessories are ordered separately.

Terminal Cover

- When a terminal cover is required, order an applicable terminal cover referring to page 67.

The Part No. development charts shown below can be used to specify control units other than those listed on the following pages. Gold-plated silver contacts are also available.

ø30 Series Pushbuttons

ABN2 11 R - MAU

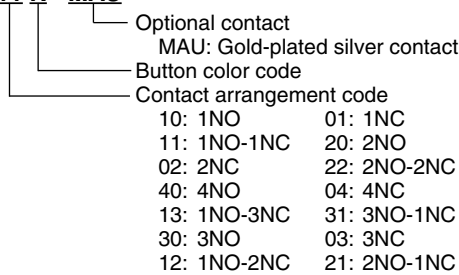

Note:

- Mushroom pull ATN23 can have a maximum of two contact blocks.
- Mushroom push-pull return ATN22 cannot have only NO or only NC contacts.
- No other contact configurations are available for square twin UWQN1 than those specified in this catalog.

ø30 Series Illuminated Pushbuttons

ALFN2 116 13 D N R - MAU

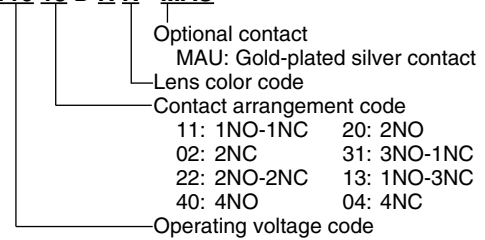

Note:

- Illuminated pushbuttons cannot have an odd number of contact blocks, such as 1NO, 1NC, 3NO, 2NO-1NC, 1NO-2NC, and 3NC.

ø30 Series Pilot Lights

APN1 116 D R

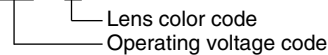

Note:

- LED lamps cannot be used on 480V AC transformers.

ø30 Series Control Units (Ordering Information) ø30

ø30 Series Selector Switch

ASN 2 L 11 - MAU

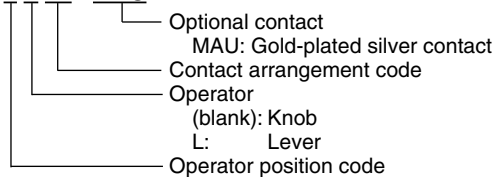

ø30 Series Illuminated Selector Switch

ASLN 2 16 22 D N R - MAU

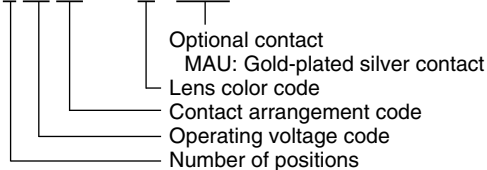

ø30 Series Key Selector Switch

ASN 2 K 11 D - MAU

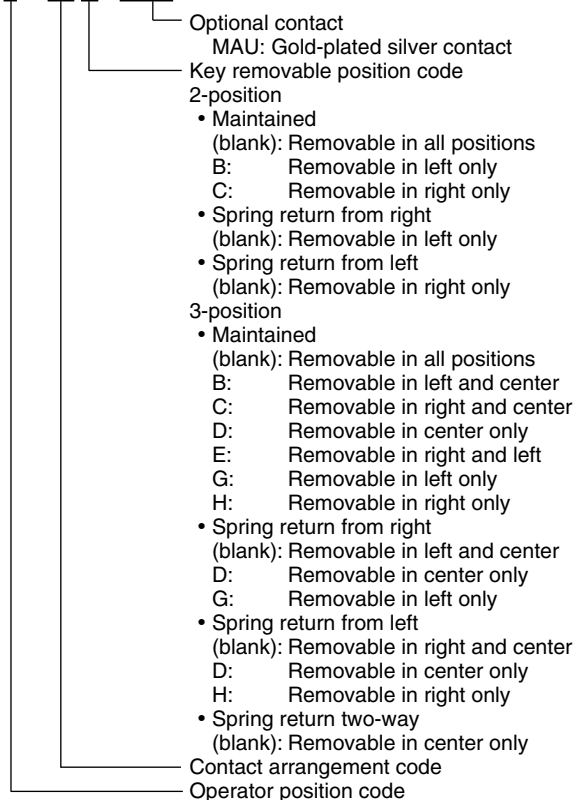













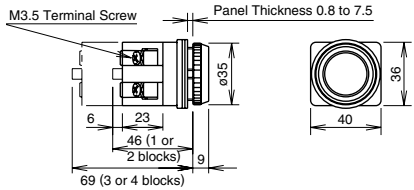

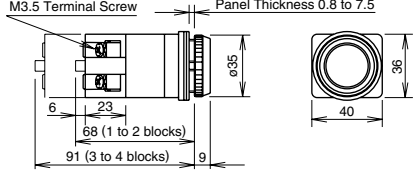

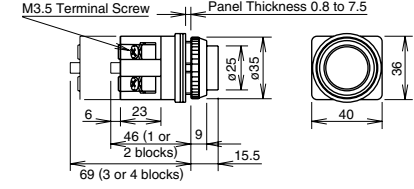
Note:

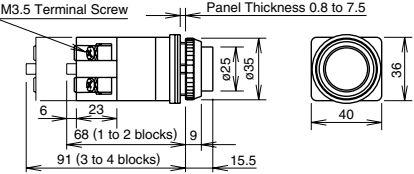
- The key cannot be removed in the return position.

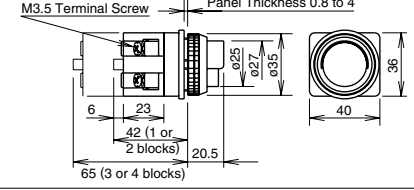
ø30 ø30 Series Pushbuttons

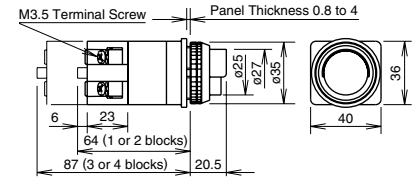
Flush / Extended / Extended w/Half Shroud / Extended w/Full Shroud Pushbuttons

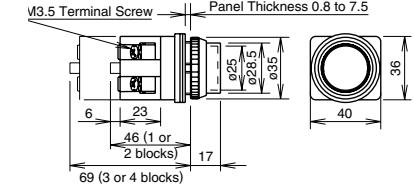
Package Quantity: 1

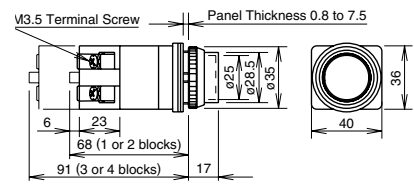







































Shape	Operation	Contact	Part No.	① Button Color Code	Dimensions (mm)
Flush ABN1  	Momentary	1NO	ABN110 ①	Black (B), green (G), and red (R) buttons are supplied with each unit.	
		1NC	ABN101 ①		
		1NO-1NC	ABN111 ①		
		2NO	ABN120 ①		
		2NC	ABN102 ①		
Flush AON1  	Maintained	1NO	AON110 ①	Specify S, W, or Y when a blue, white, or yellow button is required.	
		1NC	AON101 ①		
		1NO-1NC	AON111 ①		
		2NO	AON120 ①		
		2NC	AON102 ①		
Extended ABN2  	Momentary	1NO	ABN210 ①		
		1NC	ABN201 ①		
		1NO-1NC	ABN211 ①		
		2NO	ABN220 ①		
		2NC	ABN202 ①		
Extended AON2  	Maintained	1NO	AON210 ①		
		1NC	AON201 ①		
		1NO-1NC	AON211 ①		
		2NO	AON220 ①		
		2NC	AON202 ①		
Extended with Half Shroud ABN2G  	Momentary	1NO	ABN2G10 ①	Specify a button color code in place of ① in the Part No.	
		1NC	ABN2G01 ①		
		1NO-1NC	ABN2G11 ①		
		2NO	ABN2G20 ①		
		2NC	ABN2G02 ①		
Extended with Half Shroud AON2G  	Maintained	1NO	AON2G10 ①	B: black G: green R: red S: blue W: white Y: yellow	
		1NC	AON2G01 ①		
		1NO-1NC	AON2G11 ①		
		2NO	AON2G20 ①		
		2NC	AON2G02 ①		
Extended with Full Shroud ABN2F  	Momentary	1NO	ABN2F10 ①		
		1NC	ABN2F01 ①		
		1NO-1NC	ABN2F11 ①		
		2NO	ABN2F20 ①		
		2NC	ABN2F02 ①		
Extended with Full Shroud AON2F  	Maintained	1NO	AON2F10 ①		
		1NC	AON2F01 ①		
		1NO-1NC	AON2F11 ①		
		2NO	AON2F20 ①		
		2NC	AON2F02 ①		

- Round bezel and shroud (metal): Chrome-plated
- Other contact arrangements and gold-plated silver contacts are also available. See page 20.

ø30 Series Pushbuttons ø30

Mushroom / Jumbo Mushroom / Square Flush / Square Extended Pushbuttons

Package Quantity: 1











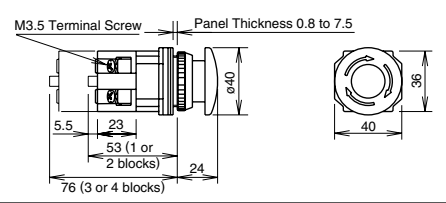

Shape	Operation	Contact	Part No.	① Button Color Code	Dimensions (mm)	
Mushroom ABN3      (nameplate sold separately)	Momentary	1NO	ABN310 ①	B: black G: green R: red S: blue W: white Y: yellow		
		1NC	ABN301 ①			
		1NO-1NC	ABN311 ①			
		2NO	ABN320 ①			
		2NC	ABN302 ①			
2NO-2NC	ABN322 ①					
Mushroom AON3      (nameplate sold separately)	Maintained	1NO	AON310 ①			
		1NC	AON301 ①			
		1NO-1NC	AON311 ①			
		2NO	AON320 ①			
		2NC	AON302 ①			
2NO-2NC	AON322 ①					
Mushroom with Full Shroud ABN3G     	Momentary	1NO	ABN3G10 ①			
		1NC	ABN3G01 ①			
		1NO-1NC	ABN3G11 ①			
		2NO	ABN3G20 ①			
		2NC	ABN3G02 ①			
2NO-2NC	ABN3G22 ①					
Palm Mushroom ABN4     	Momentary	1NO	ABN410 ①			
		1NC	ABN401 ①			
		1NO-1NC	ABN411 ①			
		2NO	ABN420 ①			
		2NC	ABN402 ①			
2NO-2NC	ABN422 ①					
Jumbo Mushroom with Shallow Shroud ABN4G     	Momentary	1NO	ABN4G10 ①	B: black G: green R: red		
		1NC	ABN4G01 ①			
		1NO-1NC	ABN4G11 ①			
		2NO	ABN4G20 ①			
		2NC	ABN4G02 ①			
2NO-2NC	ABN4G22 ①					
Jumbo Mushroom with Deep Shroud ABN4F     	Momentary	1NO	ABN4F10 ①			
		1NC	ABN4F01 ①			
		1NO-1NC	ABN4F11 ①			
		2NO	ABN4F20 ①			
		2NC	ABN4F02 ①			
2NO-2NC	ABN4F22 ①					
Square Flush UBQN1     	Momentary	1NO	UBQN110 ①	B: black G: green R: red Y: yellow		
		1NC	UBQN101 ①			
		1NO-1NC	UBQN111 ①			
		2NO	UBQN120 ①			
		2NC	UBQN102 ①			
2NO-2NC	UBQN122 ①					
Square Extended UBQN2     	Momentary	1NO	UBQN210 ①			
		1NC	UBQN201 ①			
		1NO-1NC	UBQN211 ①			
		2NO	UBQN220 ①			
		2NC	UBQN202 ①			
2NO-2NC	UBQN222 ①					

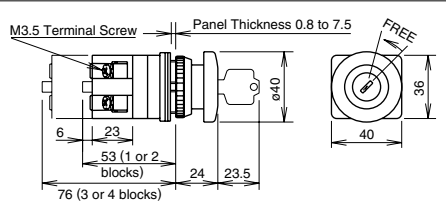
- Specify a button color code in place of ① in the Part No.
- Round/square bezel and shroud (metal): Chrome-plated
- Other contact arrangements and gold-plated silver contacts are also available. See page 20.

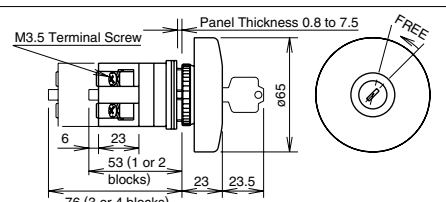
ø30 ø30 series Pushbuttons

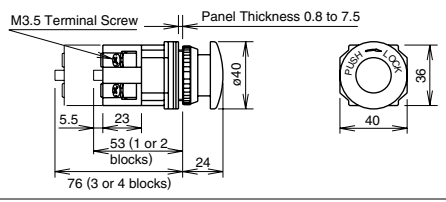
Pushlock Turn Reset / Pushlock Key Reset / Push Turn Lock / Key ON/OFF Lock / Toggle Lever Pushbuttons

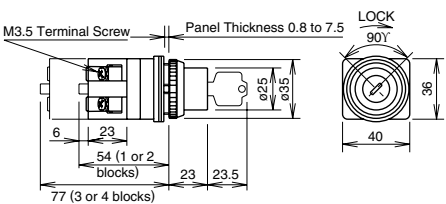

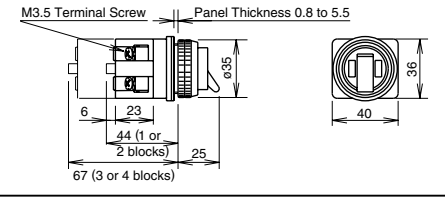



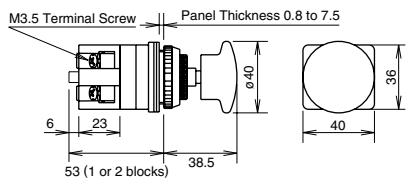

Package Quantity: 1

Shape	Contact	Part No.	① Button Color Code	Dimensions (mm)
Mushroom Pushlock Turn Reset AVN3  	1NO	AVN310N①	R: red Y: yellow	
	1NC	AVN301N①		
	1NO-1NC	AVN311N①		
	2NO	AVN320N①		
	2NC	AVN302N①		
	2NO-2NC	AVN322N①		
Mushroom Pushlock Key Reset ABN3K  (nameplate sold separately) 	1NO	ABN3K10①	B: black G: green R: red Y: yellow	
	1NC	ABN3K01①		
	1NO-1NC	ABN3K11①		
	2NO	ABN3K20①		
	2NC	ABN3K02①		
	2NO-2NC	ABN3K22①		
Jumbo Mushroom Pushlock Key Reset ABN4K  	1NO	ABN4K10①	B: black G: green R: red	
	1NC	ABN4K01①		
	1NO-1NC	ABN4K11①		
	2NO	ABN4K20①		
	2NC	ABN4K02①		
	2NO-2NC	ABN4K22①		
Mushroom Push Turn Lock AJN3  	1NO	AJN310N①	B: black G: green R: red Y: yellow	
	1NC	AJN301N①		
	1NO-1NC	AJN311N①		
	2NO	AJN320N①		
	2NC	AJN302N①		
	2NO-2NC	AJN322N①		
Key ON/OFF Lock ABN5  (nameplate sold separately) 	1NO	ABN510	-	
	1NC	ABN501		
	1NO-1NC	ABN511		
	2NO	ABN520		
	2NC	ABN502		
	2NO-2NC	ABN522		
Toggle Lever ATN4  (nameplate sold separately) 	1NO	ATN410	Lever: black	
	1NC	ATN401		
	1NO-1NC	ATN411		
	2NO	ATN420		
	2NC	ATN402		
	2NO-2NC	ATN422		

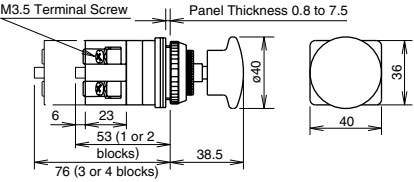
- Specify a button color code in place of ① in the Part No.
- Round bezel (metal): Chrome-plated
- Cylinder (metal): Chrome-plated
- Other contact arrangements and gold-plated silver contacts are also available. See page 20.
- **Pushlock Turn Reset:** Button is maintained when pressed and is reset when turned clockwise. Red buttons only.
- Note: ø30 pushlock turn reset switches cannot be used as emergency stop switches. When emergency stop switches are required, use XN or HN series emergency stop switches (ISO 13850 and IEC 60947-5-5 compliant).
- **Pushlock Key Reset:** Button is maintained when pressed and is reset with a key. Key is removable from both depressed and reset positions. Two keys are supplied.
- Note: ø30 pushlock key reset switches cannot be used as emergency stop switches. When emergency stop switches are required, use HW series emergency stop switches with a HW9Z-A30 ring adapter (ISO 13850 and IEC 60947-5-5 compliant).
- **Push Turn Lock:** Button is locked when turned clockwise in the depressed position and is reset when turned counterclockwise.
- **Key ON/OFF Lock:** Button can be locked in both depressed and reset positions.
- **Toggle Lever:** ON and OFF are indicated on the cap.

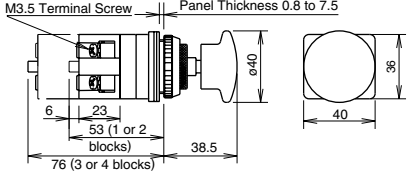
Pull / Push-Pull / Pin Lock Pushbuttons

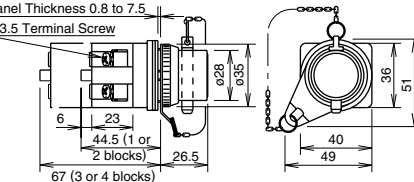
Package Quantity: 1

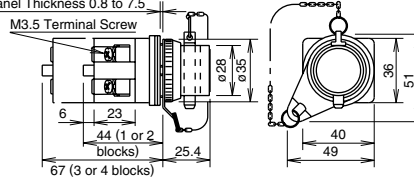
Shape	Contact	Part No.	① Button Color Code	Dimensions (mm)			
Mushroom Pull ATN23  (nameplate sold separately)	1NO	ATN2310 ①	B: black G: green R: red Y: yellow				
	1NO-1NC	ATN2311 ①					
	2NO	ATN2320 ①					
	2NC	ATN2302 ①					
Mushroom Push-Pull ATN21  (nameplate sold separately)	1NO-1NC	ATN2111 ①		B: black G: green R: red Y: yellow			
	2NO	ATN2120 ①					
	2NC	ATN2102 ①					
Mushroom Push-Pull (Spring Return) ATN22  (nameplate sold separately)	1NO-1NC	ATN2211 ①			B: black G: green R: red Y: yellow		
	2NO-2NC	ATN2222 ①					
Pin Lock ABN8P  (nameplate sold separately)	1NO	ABN8P10				-	
	1NC	ABN8P01					
	1NO-1NC	ABN8P11					
	2NO	ABN8P20					
	2NC	ABN8P02					
	2NO-2NC	ABN8P22					
Pin Lock (ON Lock) ABN8P**TK231-1  (nameplate sold separately)	1NO	ABN8P10-TK231-1	-				
	1NC	ABN8P01-TK231-1					
	1NO-1NC	ABN8P11-TK231-1					
	2NO	ABN8P20-TK231-1					
	2NC	ABN8P02-TK231-1					
	2NO-2NC	ABN8P22-TK231-1					

- Specify a button color code in place of ① in the Part No.
- Round bezel and shroud (metal): Chrome-plated
- Square bezel (metal): Chrome-plated
- Other contact arrangements and gold-plated silver contacts are also available. See page 20.
- **Pull:** Pulling the button operates the contacts. Up to 2 contact blocks (1 layer) can be mounted on pull switches.
- **Push-Pull:** Button is maintained in both depressed and reset positions.
- Note: ø30 push pull switches cannot be used as emergency stop switches. When emergency stop switches are required, use XN series emergency stop switches (ISO 13850 and IEC 60947-5-5 compliant).
- **Push-Pull (Spring Return):** Pushing or pulling the button operates the contacts. Button is spring-returned to the center position.
- **Pin Lock:** Button can be locked in either depressed or reset position by inserting the pin. Pad lock with a ø6mm pin can also be used to lock the button.
- **Pin Lock (ON Lock):** Button is locked in the depressed position by inserting the pin. Button cannot be locked in the reset position.

Contact Operation

Pull Switch (Spring Return)

Contact	ATN23	
	Normal	Pull
1NO		
1NC		
1NO-1NC		
2NO		
2NC		

Push-Pull Switch (Maintained)

Contact	ATN21	
	Push	Pull
1NO-1NC		
2NO		
2NC		
2NO-2NC		









Push-Pull (Spring Return)

Contact	ATN22		
	Push	Normal	Pull
1NO-1NC			
2NO-2NC			

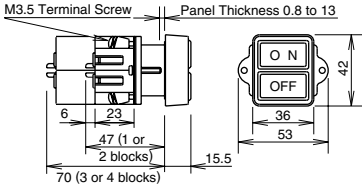
ø30 ø30 Series Pushbuttons

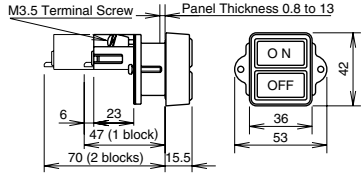
Square Twin / Twin Maintained Pushbuttons

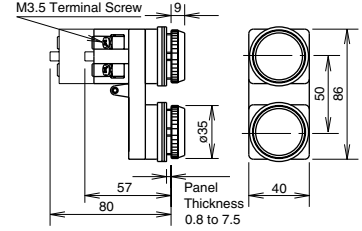
Package Quantity: 1

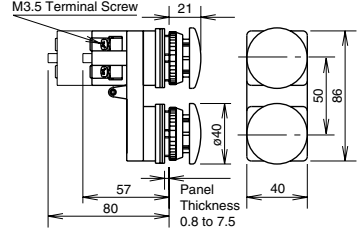

Shape	Contact		Part No.	Button Color	Dimensions (mm)
Square Twin (Momentary) UWQN1  	ON	OFF		ON: Black OFF: Red	
	1NO	1NO	UWQN11010		
	1NO	1NC	UWQN11001		
Square Twin (Maintained) UWQN2  	ON	OFF		ON: Black OFF: Red	
	1NO	–	UWQN21000		
	1NC	–	UWQN20100		
	1NO-1NC	–	UWQN21100		
	2NO	–	UWQN22000		
Flush Twin Maintained ABBN11  	Top	Bottom		Black (B), green (G), and red (R) buttons are supplied with each unit.	
	1NO	–	ABBN1110		
	1NC	–	ABBN1101		
	1NO-1NC	–	ABBN1111		
	2NO	–	ABBN1120		
	2NC	–	ABBN1102		
Mushroom Twin Maintained (Without buttons) ABBN33  	Top	Bottom			
	1NO	–	ABBN3310		
	1NC	–	ABBN3301		
	1NO-1NC	–	ABBN3311		
	2NO	–	ABBN3320		
	2NC	–	ABBN3302		
2NO-2NC	–	ABBN3322			

- Round bezel (metal): Chrome-plated
 - Other contact arrangements and gold-plated silver contacts are also available. See page 20.
 - **Square Twin (Momentary)**: Two independent momentary switches are contained in one unit, each operated by ON or OFF button. With the ø30 adapter removed from the sleeve, the unit can mount in a ø25.5mm mounting hole for the ø25 series.
 - **Square Twin (Maintained)**: The contact operates when ON button is pressed and is maintained in the depressed position. The button is reset by pressing the OFF button.
 - **Twin Maintained**: The contact operates when the top button is pressed and is maintained in the depressed position. The button is reset by pressing the bottom button.
- Different combinations of flush, extended HW9Z-A30 buttons, and colors are available (ABN1B-*, ABN2B-*). See page 73. Mushroom buttons for the ABBN33 are ordered separately. Specify the color code (ABN3B-*). See page 73.

ø30 Series Pilot Lights ø30

Dome Pilot Lights

Package Quantity: 1

Shape	Lamp	Lamp Receptacle	Part No.	② Lens/LED Color Code	Applicable Lamp
Dome APN1 APNE1  	Without Lamp	BA9S	APN199 ②	DNA: amber C: clear G: green O: orange R: red S: blue W: white DNY: yellow	See page 75 for lamps.
		E12	APNE199 ②		
	LED	BA9S	APN1 ③ DN ②	A: amber G: green PW: pure white R: red S: blue W: white Y: yellow	LSTD-*②
		E12	APNE1 ③ DN ②	A: amber G: green R: red S: blue W: white Y: yellow	LETD-*②
	Incandescent	BA9S	APN1 ③②	C: clear G: green O: orange R: red S: blue W: white	LS-*
		E12	APN1 ③②		LE-*

Operating Voltage Code

Specify an operating voltage code in place of ③ in the Part No.

③ Operating Voltage Code			Input
LED	Incandescent (BA9S)	Incandescent (E12)	
66: 6V AC/DC 11: 12V AC/DC 22: 24V AC/DC	66: 6V AC/DC 88: 12V AC/DC 33: 24V AC/DC		Full Voltage
16: 100/110V AC 116: 115V AC 126: 120V AC 26: 200/220V AC 236: 230V AC 246: 240V AC 386: 380V AC 46: 400/440V AC	16: 100/110V AC 116: 115V AC 126: 120V AC 26: 200/220V AC 236: 230V AC 246: 240V AC 386: 380V AC 46: 400/440V AC 486: 480V AC	18: 100/110V AC 118: 115V AC 128: 120V AC 238: 200/220V AC 238: 230V AC 248: 240V AC 388: 380V AC 48: 400/440V AC 488: 480V AC	Transformer
16D: 110V DC			DC-DC Converter *

- Specify a lens/LED color code in place of ② in the Part No.
 - Use a white lens for LED pure white illumination (LSTD).
 - Use a pure white LED lamp for yellow illumination.
- * DC-DC converter types are not approved by UL and CSA, and not CE compliant (operating voltage 90 to 140V DC).

Dimensions

Full Voltage

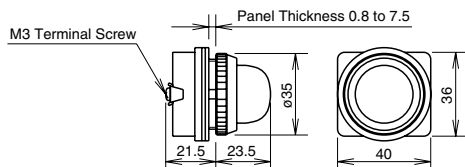

Transformer DC-DC Converter

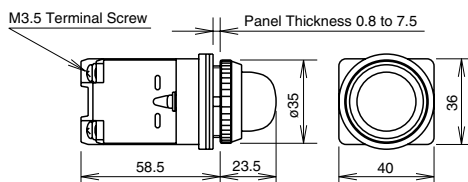







All dimensions in mm.

ø30 ø30 Series Pilot Lights

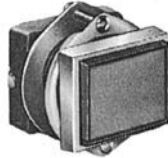
Square / Rectangular (Marking) Pilot Lights

Package Quantity: 1

Shape	Lamp	Lamp Receptacle	Part No.	② Lens/LED Color Code		Applicable Lamp
Square UPQN3B  	Without Lamp	BA9S	UPQN3B99 ②	DA: amber G: green R: red W: white	C: clear O: orange S: blue DY: yellow	See page 75 for lamps.
	LED	BA9S	UPQN3B ③ D ②	A: amber R: red W: white	G: green S: blue Y: yellow	LSTD-*②
	Incandescent	BA9S	UPQN3B ③②	C: clear O: orange S: blue	G: green R: red W: white	LS-*
Rectangular (Marking) UPQN4  	Without Lamp	BA9S	UPQN499 ②	DA: amber O: orange S: blue DY: yellow	G: green R: red W: white	See page 75 for lamps.
	LED	BA9S	UPQN4 ③ D ②	A: amber R: red W: white	G: green S: blue Y: yellow	LSTD-*②
	Incandescent	BA9S	UPQN4 ③②	G: green R: red W: white	O: orange S: blue	LS-*
Rectangular (Marking) UPQNE4 UPQN4  	Without Lamp	E12	UPQNE499 ②	DA: amber O: orange S: blue DY: yellow	G: green R: red W: white	See page 75 for lamps.
	LED	E12	UPQNE4 ③ D ②	A: amber R: red W: white	G: green S: blue Y: yellow	LETD-*②
	Incandescent	E12	UPQN4 ③② (Note)	G: green R: red W: white	O: orange S: blue	LE-*

Operating Voltage Code

Specify an operating voltage code in place of ③ in the Part No.

③ Operating Voltage Code			Input Type
LED	Incandescent (BA9S)	Incandescent (E12)	
66: 6V AC/DC 11: 12V AC/DC 22: 24V AC/DC	66: 6V AC/DC 88: 12V AC/DC 33: 24V AC/DC	66: 6V AC/DC 88: 12V AC/DC 33: 24V AC/DC (Note) When ordering 6V, 12V, 24V AC/DC units, specify "E" before the operating voltage code. UPQN4E③②.	Full Voltage
16: 100/110V AC 116: 115V AC 126: 120V AC 26: 200/220V AC 236: 230V AC 246: 240V AC 386: 380V AC 46: 400/440V AC	16: 100/110V AC 116: 115V AC 126: 120V AC 26: 200/220V AC 236: 230V AC 246: 240V AC 386: 380V AC 46: 400/440V AC 486: 480V AC	18: 100/110V AC 118: 115V AC 128: 120V AC 238: 200/220V AC 238: 230V AC 248: 240V AC 388: 380V AC 48: 400/440V AC 488: 480V AC	Transformer
16D: 110V DC			DC-DC Converter *

- Specify a lens/LED color code in place of ② in the Part No.
- Use a pure white LED lamp for yellow illumination (LSTD)
- On the rectangular marking pilot light, a clear lens and a color marking plate are used for white illumination.
Marking plate: 24 × 30 mm, 2 mm thick
- * DC-DC converter types are not approved by UL and CSA, and not CE compliant (operating voltage 90 to 140V DC).

Dimensions

Square Full Voltage UPQN3B

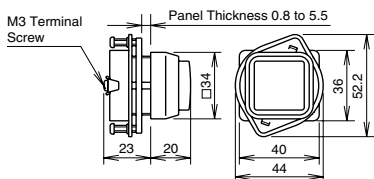

Rectangular Full Voltage UPQN4

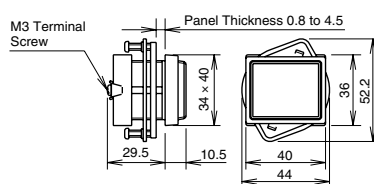

Rectangular Full Voltage UPQNE4

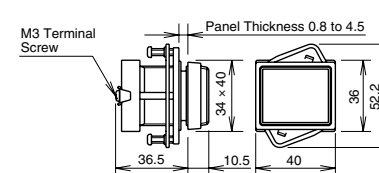

Square Transformer Square DC-DC Converter UPQN3B

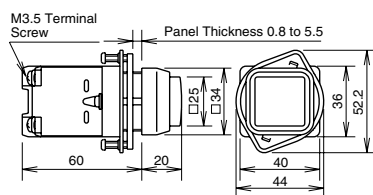

Rectangular Transformer Rectangular DC-DC Converter UPQN4

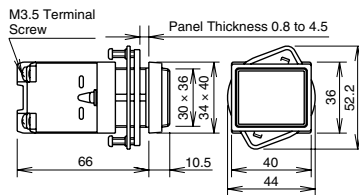

Rectangular Transformer Rectangular DC-DC Converter UPQNE4

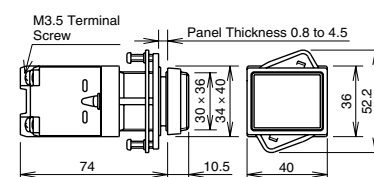

All dimensions in mm.

Reflector

1. The lamp housing of the square LED illuminated pilot lights has a built-in reflector.
2. Make sure that the reflector does not fall off when removing the lens or marking plate.
3. When replacing the LED lamp of UPQNE4 (rectangular), use a lamp holder tool (OR-55).
4. To remove the reflector, insert a flat screwdriver inside the groove of the reflector and lightly push out.

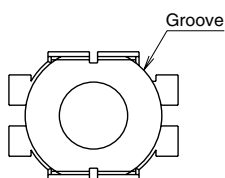

Panel Mounting

1. Tighten the square ring to the operator and position the ring correctly.
2. Lightly tighten the screw to secure the pilot light onto the panel.

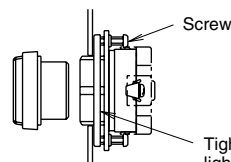

Tighten the screw lightly so that the panel does not bend.

Recommended tightening torque: 0.15 N·m

ø30 ø30 Series Pilot Lights

Incandescent Push-to-Check Pilot Lights (1W)

Package Quantity: 1

Shape	Lamp	Lamp Receptacle	Part No.	② Lens/LED Color Code	Applicable Lamp
Push-to-Check APN1*P 	Without Lamp	BA9S	APN199P ②	C: clear G: green O: orange R: red S: blue W: white	See page 75 for lamps.
	Incandescent	BA9S	APN1 ③P②		LS-*

Operating Voltage Code

Specify an operating voltage code in place of ③ in the Part No.

③ Operating Voltage Code	Input
66: 6V AC/DC 88: 12V AC/DC 33: 24V AC/DC	Full voltage
16: 100/110V AC 116: 115V AC 126: 120V AC 26: 200/220V AC 236: 230V AC 246: 240V AC 386: 380V AC 46: 400/440V AC 486: 480V AC	Transformer

Circuit Example

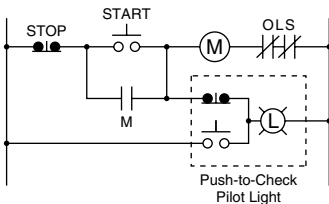

Note: The lamp of the push-to-check pilot light is not connected to the contact terminal. To connect, refer to the diagram on the left.

Dimensions

Push-to-Check
APN1*P

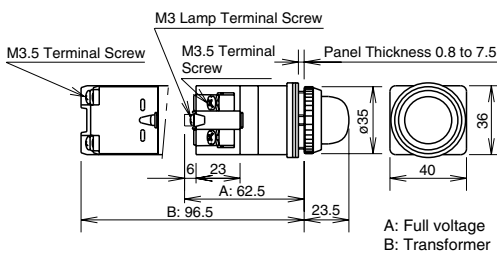



All dimensions in mm.

ø30 Series Illuminated Pushbuttons ø30

LED Round Extended Illuminated Pushbuttons

Package Quantity: 1

Shape	Lamp Receptacle	Operation	Lamp	Contact	Part No.	Applicable Lamp
Round Extended ALN2 AOLN2 ALNE2 AOLNE2  	BA9S	Momentary	Without Lamp	1NO-1NC	ALN29911DN ^②	See page 75 for lamps.
				2NO	ALN29920DN ^②	
				2NC	ALN29902DN ^②	
		LED		1NO-1NC	ALN2 ^③ 11DN ^②	LSTD-* ^②
				2NO	ALN2 ^③ 20DN ^②	
				2NC	ALN2 ^③ 02DN ^②	
	E12	Momentary	Without Lamp	1NO-1NC	AOLN29911DN ^②	See page 75 for lamps.
				2NO	AOLN29920DN ^②	
				2NC	AOLN29902DN ^②	
		LED		1NO-1NC	AOLN2 ^③ 11DN ^②	LSTD-* ^②
				2NO	AOLN2 ^③ 20DN ^②	
				2NC	AOLN2 ^③ 02DN ^②	
E12	Momentary	Without Lamp	1NO-1NC	ALNE29911DN ^②	See page 75 for lamps.	
			2NO	ALNE29920DN ^②		
			2NC	ALNE29902DN ^②		
	LED		1NO-1NC	ALNE2 ^③ 11DN ^②	LETD-* ^②	
			2NO	ALNE2 ^③ 20DN ^②		
			2NC	ALNE2 ^③ 02DN ^②		
E12	Maintained	Without Lamp	1NO-1NC	AOLNE29911DN ^②	See page 75 for lamps.	
			2NO	AOLNE29920DN ^②		
			2NC	AOLNE29902DN ^②		
	LED		1NO-1NC	AOLNE2 ^③ 11DN ^②	LETD-* ^②	
			2NO	AOLNE2 ^③ 20DN ^②		
			2NC	AOLNE2 ^③ 02DN ^②		

Color Code and Operating Voltage Code

② Lens/LED Color Code	③ Operating Voltage Code	Input
Specify a lens/LED color code in place of ②. A: amber G: green PW: pure white (LSTD only) R: red S: blue W: white Y: yellow	66: 6V AC/DC 11: 12V AC/DC 22: 24V AC/DC	Full voltage
A pure white LED lamp is used for yellow illumination.	16: 100/110V AC 116: 115V AC 126: 120V AC 26: 200/220V AC 236: 230V AC 246: 240V AC 386: 380V AC 46: 400/440V AC	Transformer

Dimensions

ALN2/AOLN2
BA9S/Full Voltage

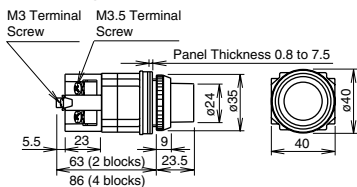

ALN2/AOLN2
BA9S/Transformer

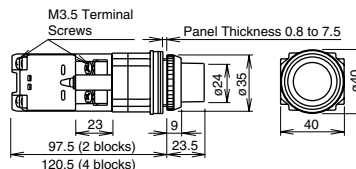

ALNE2/AOLNE2
E12/Full Voltage

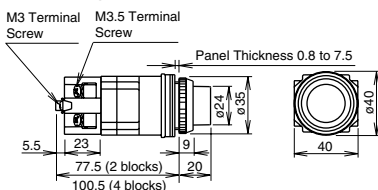

ALNE2/AOLNE2
E12/Transformer

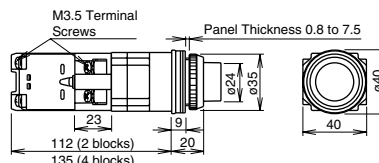





All dimensions in mm.

ø30 ø30 Series Illuminated Pushbuttons

Incandescent Round Extended Illuminated Pushbuttons

Package Quantity: 1

Shape	Lamp Receptacle	Operation	Lamp	Contact	Part No.	Applicable Lamp
Round Extended ALN ALNE   AOLN AOLNE  	BA9S	Momentary	Without Lamp	1NO-1NC	ALN9911②	See page 75 for lamps.
				2NO	ALN9920②	
				2NC	ALN9902②	
		Incandescent	1NO-1NC	ALN③11②	LS-*	
			2NO	ALN③20②		
			2NC	ALN③02②		
	E12	Momentary	Without Lamp	1NO-1NC	AOLN9911②	See page 75 for lamps.
				2NO	AOLN9920②	
				2NC	AOLN9902②	
		Incandescent	1NO-1NC	ALN③11②	LE-*	
			2NO	ALN③20②		
			2NC	ALN③02②		
Maintained	Without Lamp		1NO-1NC	AOLNE9911②	See page 75 for lamps.	
			2NO	AOLNE9920②		
			2NC	AOLNE9902②		
	Incandescent	1NO-1NC	AOLN③11②	LE-*		
		2NO	AOLN③20②			
		2NC	AOLN③02②			

Color Code and Operating Voltage Code

Specify a code in place of ② or ③ in the Part No.

② Lens Color Code	③ Operating Voltage Code		Input
	Incandescent (BA9S)	Incandescent (E12)	
Specify a lens color code in place of ②. C: clear G: green O: orange R: red S: blue W: white	66: 6V AC/DC 88: 12V AC/DC 33: 24V AC/DC	E66: 6V AC/DC E88: 12V AC/DC E33: 24V AC/DC	Full voltage
	16: 100/110V AC 116: 115V AC 126: 120V AC 26: 200/220V AC 236: 230V AC 246: 240V AC 386: 380V AC 46: 400/440V AC 486: 480V AC	18: 100/110V AC 118: 115V AC 128: 120V AC 238: 200/220V AC 238: 230V AC 248: 240V AC 388: 380V AC 48: 400/440V AC 488: 480V AC	Transformer

Dimensions

ALN Momentary BA9S/Full Voltage

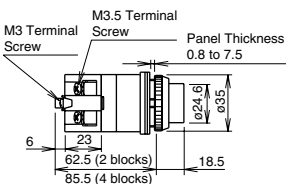

ALN Momentary BA9S/Transformer

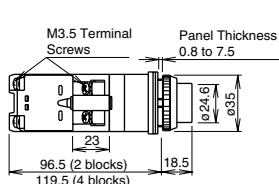

AOLN Maintained BA9S/Full Voltage

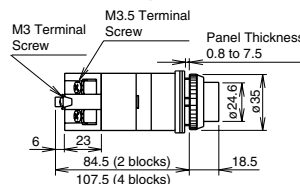

AOLN Maintained BA9S/Transformer

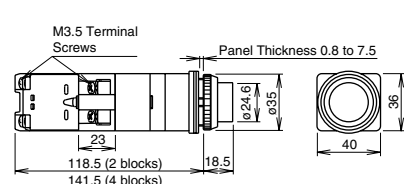

ALNE Momentary E12/Full Voltage

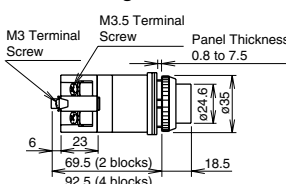

ALNE Momentary E12/Transformer

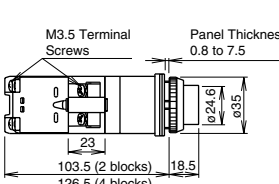

AOLNE Maintained E12/Full Voltage

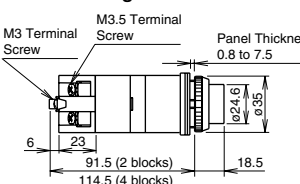

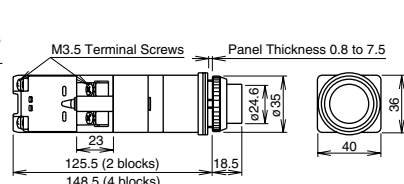

AOLNE Maintained E12/Transformer



ø30 Series Illuminated Pushbuttons ø30

LED Round Extended with Half Shroud Illuminated Pushbuttons

Package Quantity: 1

Shape	Lamp Receptacle	Operation	Lamp	Contact	Part No.	Applicable Lamp	
Round Extended ALGN2 AOLGN2 ALGNE2 AOLGNE2  	BA9S	Momentary	Without Lamp	1NO-1NC	ALGN29911DN ②	See page 75 for lamps.	
				2NO	ALGN29920DN ②		
				2NC	ALGN29902DN ②		
			LED	1NO-1NC	ALGN2 ③ 11DN ②		LSTD-*②
				2NO	ALGN2 ③ 20DN ②		
				2NC	ALGN2 ③ 02DN ②		
		Maintained	Without Lamp	1NO-1NC	AOLGN29911DN ②	See page 75 for lamps.	
				2NO	AOLGN29920DN ②		
				2NC	AOLGN29902DN ②		
			LED	1NO-1NC	AOLGN2 ③ 11DN ②		LSTD-*②
				2NO	AOLGN2 ③ 20DN ②		
				2NC	AOLGN2 ③ 02DN ②		
	E12	Momentary	Without Lamp	1NO-1NC	ALGNE29911DN ②	See page 75 for lamps.	
				2NO	ALGNE29920DN ②		
				2NC	ALGNE29902DN ②		
			LED	1NO-1NC	ALGNE2 ③ 11DN ②		LETD-*②
				2NO	ALGNE2 ③ 20DN ②		
				2NC	ALGNE2 ③ 02DN ②		
		Maintained	Without Lamp	1NO-1NC	AOLGNE29911DN ②	See page 75 for lamps.	
				2NO	AOLGNE29920DN ②		
				2NC	AOLGNE29902DN ②		
			LED	1NO-1NC	AOLGNE2 ③ 11DN ②		LETD-*②
				2NO	AOLGNE2 ③ 20DN ②		
				2NC	AOLGNE2 ③ 02DN ②		

Color Code and Operating Voltage Code

Specify a code in place of ② or ③ in the Part No.

② Lens/LED Color Code	③ Operating Voltage Code	Input
Specify a lens/LED color code in place of ②.	66: 6V AC/DC 11: 12V AC/DC 22: 24V AC/DC	Full voltage
A: amber G: green PW: pure white (LSTD only) R: red S: blue W: white Y: yellow	16: 100/110V AC 116: 115V AC 126: 120V AC 26: 200/220V AC 236: 230V AC 246: 240V AC 386: 380V AC 46: 400/440V AC	
Use a pure white LED lamp for yellow illumination		

Dimensions

**ALGN2/AOLGN2
BA9S/Full Voltage**

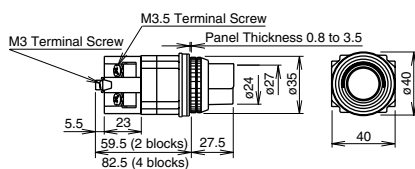

**ALGN2/AOLGN2
BA9S/Transformer**

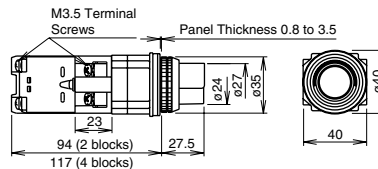

**ALGNE2/AOLGNE2
E12/Full Voltage**

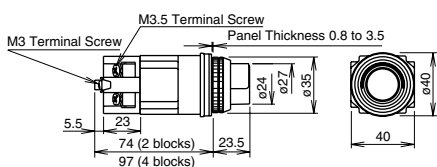

**ALGNE2/AOLGNE2
E12/Transformer**

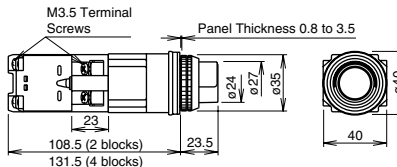





All dimensions in mm.

ø30 ø30 Series Illuminated Pushbuttons

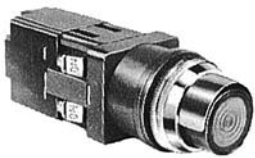
Incandescent Round Extended with Half Shroud Illuminated Pushbuttons

Package Quantity: 1

Shape	Lamp Receptacle	Operation	Lamp	Contact	Part No.	Applicable Lamp
Round Extended ALN□G ALNE□G     	BA9S	Momentary	Without Lamp	1NO-1NC	ALN9G911②	See page 75 for lamps.
				2NO	ALN9G920②	
				2NC	ALN9G902②	
			Incandescent	1NO-1NC	ALN③11②	LS-*
				2NO	ALN③20②	
				2NC	ALN③02②	
	E12	Momentary	Without Lamp	1NO-1NC	ALNE9G911②	See page 75 for lamps.
				2NO	ALNE9G920②	
				2NC	ALNE9G902②	
			Incandescent	1NO-1NC	ALN③11②	LE-*
				2NO	ALN③20②	
				2NC	ALN③02②	

Color Code and Operating Voltage Code

Specify a code in place of ② or ③ in the Part No.

② Lens Color Code	③ Operating Voltage Code		Input
	Incandescent (BA9S)	Incandescent (E12)	
Specify a lens color code in place of ②. C: clear G: green O: orange R: red S: blue W: white	6G6: 6V AC/DC 8G8: 12V AC/DC 3G3: 24V AC/DC 1G6: 100/110V AC 11G6: 115V AC 12G6: 120V AC 2G6: 200/220V AC 23G6: 230V AC 24G6: 240V AC 38G6: 380V AC 4G6: 400/440V AC 48G6: 480V AC	E6G6: 6V AC/DC E8G8: 12V AC/DC E3G3: 24V AC/DC 1G8: 100/110V AC 11G8: 115V AC 12G8: 120V AC 2G8: 200/220V AC 23G8: 230V AC 24G8: 240V AC 38G8: 380V AC 4G8: 400/440V AC 48G8: 480V AC	Full voltage Transformer

Dimensions

ALN*G Momentary
BA9S/Full Voltage

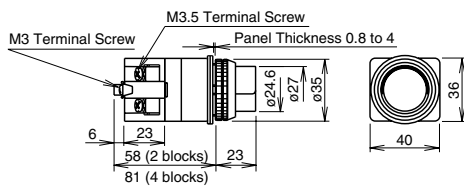

ALN*G Momentary
BA9S/Transformer

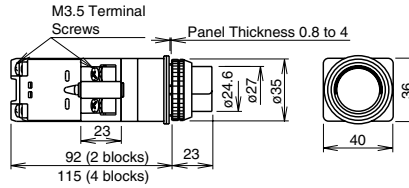

ALNE*G Momentary
E16/Full Voltage

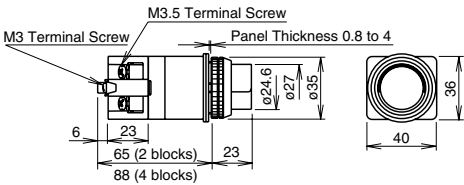

ALNE*G Momentary
E16/Transformer

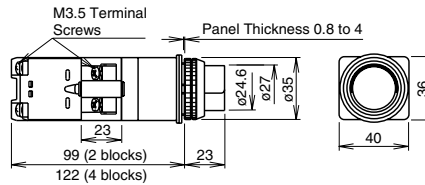

All dimensions in mm.

ø30 Series Illuminated Pushbuttons ø30

LED Round Extended with Full Shroud Illuminated Pushbuttons

Package Quantity: 1

Shape	Lamp Receptacle	Operation	Lamp	Contact	Part No.	Applicable Lamp	
	BA9S	Momentary	Without Lamp	1NO-1NC	ALFN29911DN ②	See page 75 for lamps.	
				2NO	ALFN29920DN ②		
				2NC	ALFN29902DN ②		
		LED	Without Lamp	1NO-1NC	ALFN2 ③ 11DN ②	LSTD-*②	
				2NO	ALFN2 ③ 20DN ②		
				2NC	ALFN2 ③ 02DN ②		
	E12	Momentary	Without Lamp	Without Lamp	1NO-1NC	AOLFN29911DN ②	See page 75 for lamps.
					2NO	AOLFN29920DN ②	
					2NC	AOLFN29902DN ②	
		LED	Without Lamp	1NO-1NC	AOLFN2 ③ 11DN ②	LSTD-*②	
				2NO	AOLFN2 ③ 20DN ②		
				2NC	AOLFN2 ③ 02DN ②		
E12	Maintained	Without Lamp	Without Lamp	1NO-1NC	ALFNE29911DN ②	See page 75 for lamps.	
				2NO	ALFNE29920DN ②		
				2NC	ALFNE29902DN ②		
	LED	Without Lamp	1NO-1NC	ALFNE2 ③ 11DN ②	LETD-*②		
			2NO	ALFNE2 ③ 20DN ②			
			2NC	ALFNE2 ③ 02DN ②			
E12	Maintained	Without Lamp	Without Lamp	1NO-1NC	AOLFNE29911DN ②	See page 75 for lamps.	
				2NO	AOLFNE29920DN ②		
				2NC	AOLFNE29902DN ②		
	LED	Without Lamp	1NO-1NC	AOLFNE2 ③ 11DN ②	LETD-*②		
			2NO	AOLFNE2 ③ 20DN ②			
			2NC	AOLFNE2 ③ 02DN ②			



Color Code and Operating Voltage Code

Specify a code in place of ② or ③ in the Part No.

② Lens/LED Color Code	③ Operating Voltage Code	Input
LED		
Specify a lens/LED color code in place of ②. A: amber G: green PW: pure white (LSTD only) R: red S: blue W: white Y: yellow Use a pure white LED lamp for yellow illumination	66: 6V AC/DC 11: 12V AC/DC 22: 24V AC/DC 16: 100/110V AC 116: 115V AC 126: 120V AC 26: 200/220V AC 236: 230V AC 246: 240V AC 386: 380V AC 46: 400/440V AC	Full voltage Transformer

Dimensions

ALFN2/AOLFN2
BA9S/Full Voltage

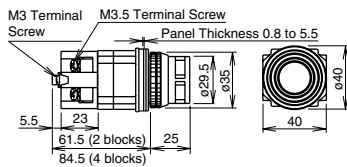

ALFN2/AOLFN2
BA9S/Transformer

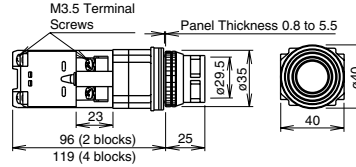

ALFNE2/AOLFNE2
E12/Full Voltage

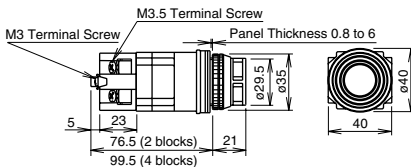

ALFNE2/AOLFNE2
E12/Transformer

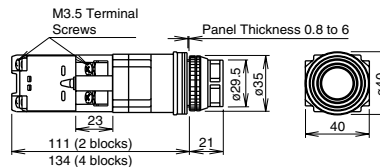



All dimensions in mm.

ø30 ø30 Series Illuminated Pushbuttons

Incandescent Round Extended with Full Shroud Illuminated Pushbuttons

Package Quantity: 1

Shape	Lamp Receptacle	Operation	Lamp	Contact	Part No.	Applicable Lamp
Round Extended ALN□F ALNE□F   UL LISTED SF CE CCC	BA9S	Momentary	Without Lamp	1NO-1NC	ALN9F911②	See page 75 for lamps.
				2NO	ALN9F920②	
				2NC	ALN9F902②	
		Incandescent	1NO-1NC	ALN③11②	LS-*	
			2NO	ALN③20②		
			2NC	ALN③02②		
	E12	Momentary	Without Lamp	1NO-1NC	AOLN9F911②	See page 75 for lamps.
				2NO	AOLN9F920②	
				2NC	AOLN9F902②	
		Incandescent	1NO-1NC	ALN③11②	LE-*	
			2NO	ALN③20②		
			2NC	ALN③02②		
E12	Maintained	Without Lamp	1NO-1NC	AOLNE9F911②	See page 75 for lamps.	
			2NO	AOLNE9F920②		
			2NC	AOLNE9F902②		
	Incandescent	1NO-1NC	AOLN③11②	LE-*		
		2NO	AOLN②20②			
		2NC	AOLN③02②			

Color Code and Operating Voltage Code

Specify a code in place of ② or ③ in the Part No.

② Lens Color Code	③ Operating Voltage Code		Input
	Incandescent (BA9S)	Incandescent (E12)	
Specify a lens color code in place of ②. C: clear G: green O: orange R: red S: blue W: white	6F6: 6V AC/DC 8F8: 12V AC/DC 3F3: 24V AC/DC	E6F6: 6V AC/DC E8F8: 12V AC/DC E3F3: 24V AC/DC	Full voltage
	1F6: 100/110V AC 11F6: 115V AC 12F6: 120V AC 2F6: 200/220V AC 23F6: 230V AC 24F6: 240V AC 38F6: 380V AC 4F6: 400/440V AC 48F6: 480V AC	1F8: 100/110V AC 11F8: 115V AC 12F8: 120V AC 2F8: 200/220V AC 23F8: 230V AC 24F8: 240V AC 38F8: 380V AC 4F8: 400/440V AC 48F8: 480V AC	Transformer

Dimensions

All dimensions in mm.

ALN*F Momentary BA9S/Full Voltage

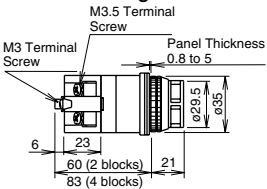

ALN*F Momentary BA9S/Transformer

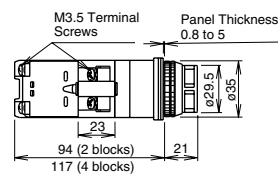

AOLN*F Maintained BA9S/Full Voltage

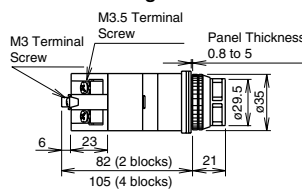

ALON*F Maintained BA9S/Transformer

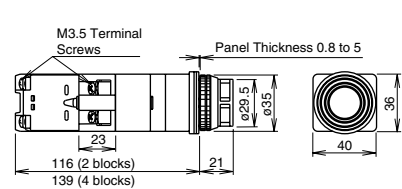

ALNE*F Momentary E12/Full Voltage

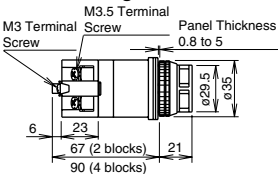

ALN*F Momentary E12/Transformer

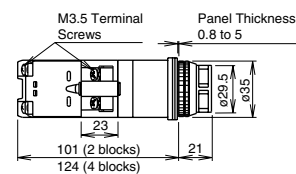

AOLNE*F Maintained E12/Full Voltage

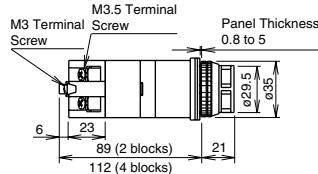

AOLN*F Maintained E12/Transformer

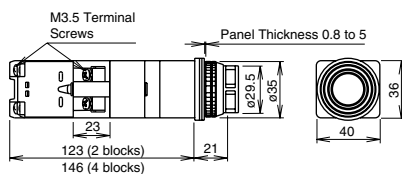

ø30 Series Illuminated Pushbuttons ø30

LED Mushroom (ø40) Illuminated Pushbuttons

Package Quantity: 1

Shape	Lamp Receptacle	Operation	Lamp	Contact	Part No.	Applicable Lamp	
	BA9S	Momentary	Without Lamp	1NO-1NC	ALN39911DN ②	See page 75 for lamps.	
				2NO	ALN39920DN ②		
				2NC	ALN39902DN ②		
		LED	Without Lamp	1NO-1NC	ALN3③11DN ②	LSTD-*②	
				2NO	ALN3③20DN ②		
				2NC	ALN3③02DN ②		
	E12	Momentary	Without Lamp	Without Lamp	1NO-1NC	AOLN39911DN ②	See page 75 for lamps.
					2NO	AOLN39920DN ②	
					2NC	AOLN39902DN ②	
		LED	Without Lamp	1NO-1NC	AOLN3③11DN ②	LSTD-*②	
				2NO	AOLN3③20DN ②		
				2NC	AOLN3③02DN ②		
E12	Maintained	Without Lamp	Without Lamp	1NO-1NC	ALNE39911DN ②	See page 75 for lamps.	
				2NO	ALNE39920DN ②		
				2NC	ALNE39902DN ②		
	LED	Without Lamp	1NO-1NC	ALNE3③11DN ②	LETD-*②		
			2NO	ALNE3③20DN ②			
			2NC	ALNE3③02DN ②			
E12	Maintained	Without Lamp	Without Lamp	1NO-1NC	AOLNE39911DN ②	See page 75 for lamps.	
				2NO	AOLNE39920DN ②		
				2NC	AOLNE39902DN ②		
	LED	Without Lamp	1NO-1NC	AOLNE3③11DN ②	LETD-*②		
			2NO	AOLNE3③20DN ②			
			2NC	AOLNE3③02DN ②			



Color Code and Operating Voltage Code

Specify a code in place of ② or ③ in the Part No.

② Lens/LED Color Code	③ Operating Voltage Code	Input
Specify a lens/LED color code in place of ②. A: amber G: green R: red S: blue W: white Y: yellow Use a pure white LED lamp for yellow illumination (LSTD only)	66: 6V AC/DC 11: 12V AC/DC 22: 24V AC/DC 16: 100/110V AC 116: 115V AC 126: 120V AC 26: 200/220V AC 236: 230V AC 246: 240V AC 386: 380V AC 46: 400/440V AC	Full voltage Transformer

Dimensions

**ALN3/AOLN3
BA9S/Full Voltage**

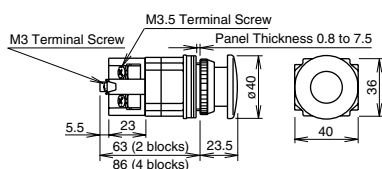

**ALN3/AOLN3
BA9S/Transformer**

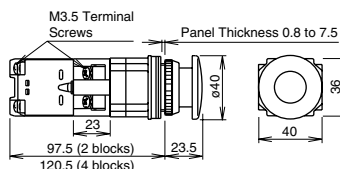

**ALNE3/AOLNE3
E12/Full Voltage**

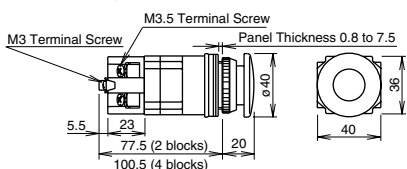

**ALNE3/AOLNE3
E12/Transformer**

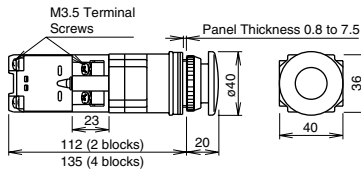



All dimensions in mm.

ø30 ø30 Series Illuminated Pushbuttons

Incandescent Square and Rectangular Extended Illuminated Pushbuttons

Package Quantity: 1

Shape	Lamp Receptacle	Operation	Lamp	Contact	Part No.	Applicable Lamp		
Square Extended ULQN   UOLQN  	BA9S	Momentary	Without Lamp	1NO-1NC	ULQN9911②	See page 75 for lamps.		
				2NO	ULQN9920②			
				2NC	ULQN9902②			
				Maintained	Without Lamp	1NO-1NC	UOLQN9911②	See page 75 for lamps.
						2NO	UOLQN9920②	
						2NC	UOLQN9902②	
				Momentary	Without Lamp	1NO-1NC	ULQN③11②	LS-*
						2NO	ULQN③20②	
						2NC	ULQN③02②	
				Maintained	Without Lamp	1NO-1NC	UOLQN③11②	LS-*
						2NO	UOLQN③20②	
						2NC	UOLQN③02②	
				Momentary	Without Lamp	1NO-1NC	ULQN9B911②	See page 75 for lamps.
						2NO	ULQN9B920②	
						2NC	ULQN9B902②	
				Maintained	Without Lamp	1NO-1NC	UOLQN9B911②	See page 75 for lamps.
						2NO	UOLQN9B920②	
						2NC	UOLQN9B902②	
				Momentary	Incandescent	1NO-1NC	ULQN③11②	LS-*
						2NO	ULQN③20②	
						2NC	ULQN③02②	
				Maintained	Incandescent	1NO-1NC	UOLQN③11②	LS-*
						2NO	UOLQN③20②	
						2NC	UOLQN③02②	

Color Code and Operating Voltage Code

Specify a code in place of ② or ③ in the Part No.

② Lens Color Code	③ Operating Voltage Code		Input
	Square Extended	Rectangular Marking	
Specify a lens color code in place of ②. C: clear (square units only) G: green O: orange R: red S: blue W: white Clear lens is not available for rectangular units.	66: 6V AC/DC 88: 12V AC/DC 33: 24V AC/DC 16: 100/110V AC 116: 115V AC 126: 120V AC 26: 200/220V AC 236: 230V AC 246: 240V AC 386: 380V AC 46: 400/440V AC 486: 480V AC	6B6: 6V AC/DC 8B8: 12V AC/DC 3B3: 24V AC/DC 1B6: 100/110V AC 11B6: 115V AC 12B6: 120V AC 2B6: 200/220V AC 23B6: 230V AC 24B6: 240V AC 38B6: 380V AC 4B6: 400/440V AC 48B6: 480V AC	Full voltage Transformer

Dimensions

All dimensions in mm.

ULQN Momentary BA9S/Full Voltage

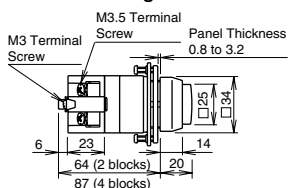

ULQN Momentary BA9S/Transformer

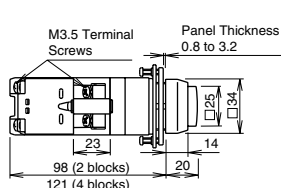

UOLQN Maintained BA9S/Full Voltage

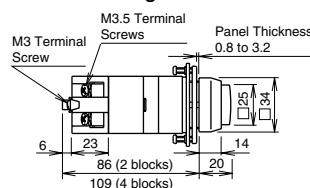

UOLQN Maintained BA9S/Transformer

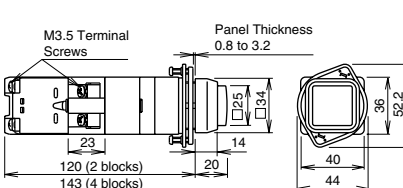

ULQN*B Momentary BA9S/Full Voltage

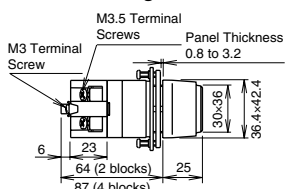

ULQN*B Momentary BA9S/Transformer

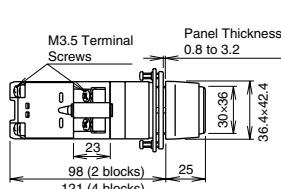

UOLQN*B Maintained BA9S/Full Voltage

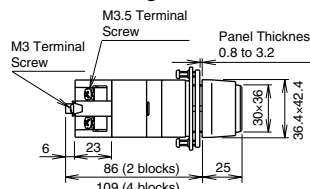

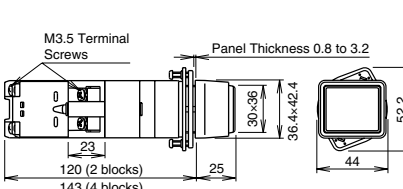

UOLQN*B Maintained BA9S/Transformer



ø30 Series Illuminated Pushbuttons ø30

Incandescent Push Turn Lock Illuminated Pushbuttons

Package Quantity: 1

Shape	Lamp Receptacle	Operation	Lamp	Contact	Part No.	Applicable Lamp
ALN□L  	BA9S	Push Turn Lock	Without Lamp	1NO-1NC	ALN9L911②	See page 75 for lamps.
				2NO	ALN9L920②	
				2NC	ALN9L902②	
			Incandescent	1NO-1NC	ALN③11②	LS-*
				2NO	ALN③20②	
				2NC	ALN③02②	

Color Code and Operating Voltage Code

Specify a code in place of ② or ③ in the Part No.

② Lens Color Code	③ Operating Voltage Code	Input
Specify a lens color code in place of ②. G: green O: orange R: red S: blue W: white	6L6: 6V AC/DC 8L8: 12V AC/DC 3L3: 24V AC/DC 1L6: 100/110V AC 11L6: 115V AC 12L6: 120V AC 2L6: 200/220V AC 23L6: 230V AC 24L6: 240V AC 38L6: 380V AC 4L6: 400/440V AC 48L6: 480V AC	Full voltage Transformer

• **Push Turn Lock:** Knob is maintained when turned clockwise in the depressed position and is reset when turned counterclockwise.

Dimensions

ALN□L
BA9S/Full Voltage

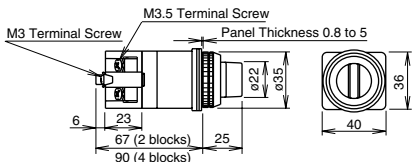

ALN□L
BA9S/Transformer

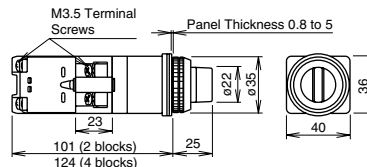





All dimensions in mm.

ø30 ø30 Series Illuminated Pushbuttons

LED Pushlock Turn Reset/Push Turn Lock Illuminated Pushbuttons

Package Quantity: 1

Shape	Lamp Receptacle	Operation	Lamp	Contact	Part No.	Applicable Lamp
ø40 Mushroom Pushlock Turn Reset AVLN3 AVLNE3  	BA9S	Pushlock Turn Reset	Without Lamp	1NO-1NC	AVLN39911DNR	See page 75 for lamps.
				2NO	AVLN39920DNR	
				2NC	AVLN39902DNR	
			LED	1NO-1NC	AVLN3③11DNR	LSTD-*②
				2NO	AVLN3③20DNR	
				2NC	AVLN3③02DNR	
	E12	Pushlock Turn Reset	Without Lamp	1NO-1NC	AVLNE39911DNR	See page 75 for lamps.
				2NO	AVLNE39920DNR	
				2NC	AVLNE39902DNR	
			LED	1NO-1NC	AVLNE3③11DNR	LETD-*②
				2NO	AVLNE3③20DNR	
				2NC	AVLNE3③02DNR	
ø40 Mushroom Push Turn Lock AJLN3  	BA9S	Push Turn Lock	Without Lamp	1NO-1NC	AJLN39911DN②	See page 75 for lamps.
				2NO	AJLN39920DN②	
				2NC	AJLN39902DN②	
			LED	1NO-1NC	AJLN3③11DN②	LSTD-*②
				2NO	AJLN3③20DN②	
				2NC	AJLN3③02DN②	

Color Code and Operating Voltage Code

Specify a code in place of ② or ③ in the Part No.

② Lens/LED Color Code	③ Operating Voltage Code	Input
Specify a lens/LED color code in place of ②.	66: 6V AC/DC 11: 12V AC/DC 22: 24V AC/DC	Full voltage
A: amber G: green R: red W: white Y: yellow	16: 100/110V AC 116: 115V AC 126: 120V AC 26: 200/220V AC 236: 230V AC 246: 240V AC 386: 380V AC 46: 400/440V AC	

- **Pushlock Turn Reset:** Lens is maintained when pressed and is reset when turned clockwise. Red lens only.
Note: AVLN3 and AVLNE3 pushlock turn reset switches cannot be used as emergency stop switches. When emergency stop switches are required, use XN or HN series emergency stop switches (ISO 13850 and IEC 60947-5-5 compliant).
- **Push Turn Lock:** Lens is maintained when turned clockwise in the depressed position and is reset when turned counterclockwise.

Dimensions

**AVLN3
BA9S/Full Voltage**

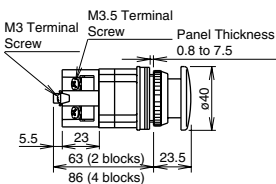

**AVLN3
BA9S/Transformer**

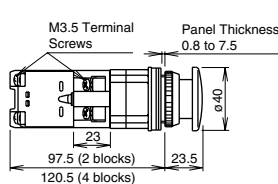

**AVLNE3
E12/Full Voltage**

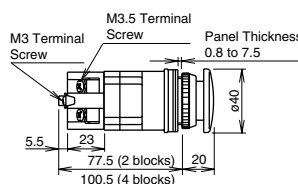

**AVLNE3
E12/Transformer**

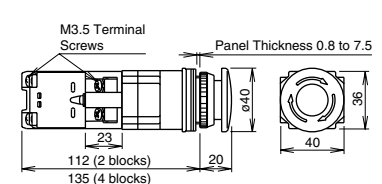

**AJLN3
BA9S/Full Voltage**

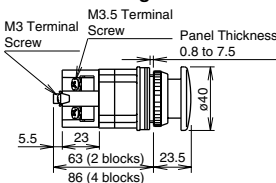

**AJLN3
BA9S/Transformer**

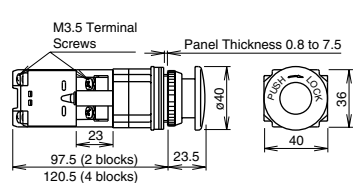





All dimensions in mm.

ø30 Series Illuminated Pushbuttons ø30

Incandescent Pushlock Turn Reset/Push Turn Lock Illuminated Pushbuttons

Package Quantity: 1

Shape	Lamp Receptacle	Operation	Lamp	Contact	Part No.	Applicable Lamp
ø40 Mushroom Pushlock Turn Reset AVLN3 AVLNE3  	BA9S	Pushlock Turn Reset	Without Lamp	1NO-1NC	AVLN39911NR	See page 75 for lamps.
				2NO	AVLN39920NR	
				2NC	AVLN39902NR	
			Incandescent	1NO-1NC	AVLN3③11NR	LS-*
				2NO	AVLN3③20NR	
				2NC	AVLN3③02NR	
	E12	Pushlock Turn Reset	Without Lamp	1NO-1NC	AVLNE39911NR	See page 75 for lamps.
				2NO	AVLNE39920NR	
				2NC	AVLNE39902NR	
			Incandescent	1NO-1NC	AVLNE3③11NR	LE-*
				2NO	AVLNE3③20NR	
				2NC	AVLNE3③02NR	
ø40 Mushroom Push Turn Lock AJLN3  	BA9S	Push Turn Lock	Without Lamp	1NO-1NC	AJLN39911N②	See page 75 for lamps.
				2NO	AJLN39920N②	
				2NC	AJLN39902N②	
			Incandescent	1NO-1NC	AJLN3③11N②	LS-*
				2NO	AJLN3③20N②	
				2NC	AJLN3③02N②	

Color Code and Operating Voltage Code

Specify a code in place of ② or ③ in the Part No.

② Lens Color Code	③ Operating Voltage Code		Input
	Incandescent (BA9S)	Incandescent (E12)	
Specify a lens color code in place of ② in the Part No. G: green O: orange R: red	66: 6V AC/DC 88: 12V AC/DC 33: 24V AC/DC		Full voltage
	16: 100/110V AC 116: 115V AC 126: 120V AC 26: 200/220V AC 236: 230V AC 246: 240V AC 386: 380V AC 46: 400/440V AC 486: 480V AC	18: 100/110V AC 118: 115V AC 128: 120V AC 238: 200/220V AC 238: 230V AC 248: 240V AC 388: 380V AC 48: 400/440V AC 488: 480V AC	Transformer

- **Pushlock Turn Reset:** Lens is maintained when pressed and is reset when turned clockwise. Red lens only.
 Note: AVLN3 and AVLNE3 pushlock turn reset switches cannot be used as emergency stop switches. When emergency stop switches are required, use XN or HN series emergency stop switches (ISO 13850 and IEC 60947-5-5 compliant).
- **Push Turn Lock:** Lens is maintained when turned clockwise in the depressed position and is reset when turned counterclockwise.

Dimensions

AVLN3

BA9S/Full Voltage

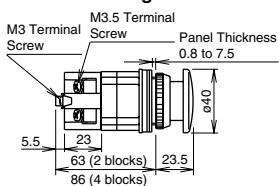

AVLN3

BA9S/Transformer

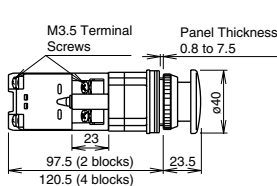

AVLNE3

E12/Full Voltage

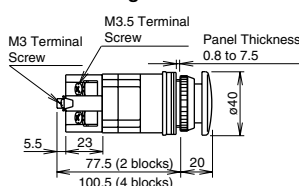

AVLNE3

E12/Transformer

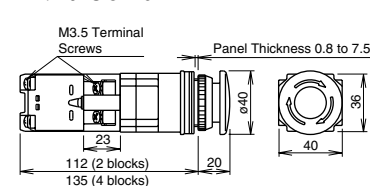

AJLN3

BA9S/Full Voltage

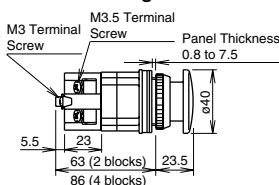

AJLN3

BA9S/Transformer

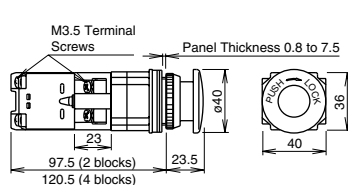







All dimensions in mm.

ø30 ø30 Series Selector Switches

ASN Selector Switches (Knob Operator)

90° 2-position

Package Quantity: 1

Shape			ASN				 <ul style="list-style-type: none"> • Knob: Black • Round bezel (metal): Chrome-plated • Units marked with ★ and part numbers with "-T" differ in shape. See page 48 for dimensions. • Nameplates are ordered separately. 																	
Contact Arrangement Chart																								
Contact Code	Contact Block		Operator Position		Maintained	Spring Return from Right	Maintained	Spring Return from Left																
	Mounting Position	Contact	L	R																				
10 (1NO)	1	NO		●	ASN310	ASN410	/	/																
	2	Dummy																						
11 (1NO-1NC)	1	NO		●	ASN311	ASN411			/	/														
	2	NC	●																					
20 (2NO)	1	NO		●	ASN320	ASN420					/	/												
	2	NO		●																				
22 (2NO-2NC)	1	NO		●	ASN322	ASN422							/	/										
	2	NC	●																					
	3	NO		●																				
	4	NC	●																					
7S (1NO-1NC)	1	NO	■		ASN37S (Note)	ASN47S (Note)									/	/								
	2	NC	■																					
10 (1NO)	1	NO	●		/	/	/	/																
	2	Dummy																						
11 (1NO-1NC)	1	NO	●						/	/							/	/						
	2	NC		●																				
20 (2NO)	1	NO	●								/	/							/	/				
	2	NO		●																				
22 (2NO-2NC)	1	NO	●										/	/							/	/		
	2	NC		●																				
	3	NO	●																					
	4	NC		●																				
7S (1NO-1NC)	1	NO	■												ASN307S (Note)	ASN407S (Note)							/	/
	2	NC	■																					













Note: The overlapping time is shorter for left to right than right to left. Take overlapping time into consideration.

ø30 Series Selector Switches ø30

ASN Selector Switches (Knob Operator)

45° 3-position

Package Quantity: 1

Shape			ASN						<ul style="list-style-type: none"> • Knob: Black • Round bezel (metal): Chrome-plated • Units marked with ★ and part numbers with "-T" differ in shape. See page 48 for dimensions. • Nameplates are ordered separately. 			
Contact Arrangement Chart			   									
Contact Code	Contact Block		Operator Position			Maintained	Spring Return from Left	Maintained	Spring Return from Right			
	Mounting Position	Contact	L	R	C							
11 (1NO-1NC)	1	NO	●			*ASN111	*ASN211					
	2	NC			●							
20 (2NO)	1	NO	●			ASN120-T	ASN220-T					
	2	NO			●							
22 (2NO-2NC)	1	NO	●			*ASN122	*ASN222					
	2	NO			●							
	3	NC	●									
	4	NC			●							
40 (4NO)	1	NO	●			ASN140-T	ASN240-T					
	2	NO			●							
	3	NO	●									
	4	NO			●							
22 (2NO-2NC)	1	NO	●			ASN15S ★	ASN25S ★					
	2	NO			●							
	3	NC	■	■								
	4	NC	■	■								
02 (2NC)	1	NC	■	■		ASN17S ★	ASN27S ★					
	2	NC	■	■								
04 (4NC)	1	NC	■	■		ASN18S ★	ASN28S ★					
	2	NC	■	■								
	3	NC	■	■								
	4	NC	■	■								
11 (1NO-1NC)	1	NO			●			*ASN1011	*ASN2011			
	2	NC	●					—	ASN2002-T			
02 (2NC)	1	NC	●									
	2	NC	●									
22 (2NO-2NC)	1	NO	●					*ASN1022	*ASN2022			
	2	NC			●							
	3	NO	●									
	4	NC	●									
04 (4NC)	1	NC	●					—	ASN2004-T			
	2	NC	●									
	3	NC	●									
	4	NC	●									
22 (2NO-2NC)	1	NO	●					ASN105S ★	ASN205S ★			
	2	NO	●									
	3	NC	■	■				ASN107S ★	ASN20L7S ★			
	4	NC	■	■								
02 (2NC)	1	NC	■	■								
	2	NC	■	■								
04 (4NC)	1	NC	■	■				ASN108S ★	ASN208S ★			
	2	NC	■	■								
	3	NC	■	■								
	4	NC	■	■								







ASN-T are twin-rod units. Single rods are available for the same circuit (marked with *) but different contacts are used.

ø30 ø30 Series Selector Switches

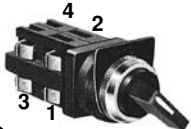
ASN□L Selector Switches (Lever Operator)

90° 2-position

Package Quantity: 1

Shape			ASN□L				 <ul style="list-style-type: none"> • Lever: Black • Round bezel (metal): Chrome-plated • Units marked with ★ and part numbers with "-T" differ in shape. • See page 48 for dimensions. • Nameplates are ordered separately. 																	
Contact Arrangement Chart																								
Contact Code	Contact Block		Operator Position		Maintained	Spring Return from Right	Maintained	Spring Return from Left																
	Mounting Position	Contact	L	R																				
10 (1NO)	1	NO		●	ASN3L10	ASN4L10	/	/																
	2	Dummy																						
11 (1NO-1NC)	1	NO		●	ASN3L11	ASN4L11			/	/														
	2	NC	●																					
20 (2NO)	1	NO		●	ASN3L20	ASN4L20					/	/												
	2	NO		●																				
22 (2NO-2NC)	1	NO		●	ASN3L22	ASN4L22							/	/										
	2	NC	●																					
	3	NO		●																				
	4	NC	●																					
7S (1NO-1NC)	1	NO		●	ASN3L7S (Note)	ASN4L7S (Note)									/	/								
	2	NC	●																					
10 (1NO)	1	NO	●		/	/	/	/																
	2	Dummy																						
11 (1NO-1NC)	1	NO	●						/	/							/	/						
	2	NC		●																				
20 (2NO)	1	NO	●								/	/							/	/				
	2	NO	●																					
22 (2NO-2NC)	1	NO	●										/	/							/	/		
	2	NC		●																				
	3	NO	●																					
	4	NC		●																				
7S (1NO-1NC)	1	NO	●												ASN3L7S (Note)	ASN4L7S (Note)							/	/
	2	NC		●																				







Note: The overlapping time is shorter for left to right than right to left. Take overlapping time into consideration.

ø30 Series Selector Switches ø30

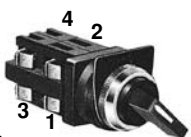
ASN□L Selector Switches (Lever Operator)

45° 3-position

Package Quantity: 1

Shape			ASNL				 <ul style="list-style-type: none"> Lever: Black Round bezel (metal): Chrome-plated Units marked with ★ and part numbers with "-T" differ in shape. See page 48 for dimensions. Nameplates are ordered separately. 		
Contact Arrangement Chart					<div style="display: flex; justify-content: space-around;"> <div style="text-align: center;"> <p>Maintained</p>  </div> <div style="text-align: center;"> <p>Spring Return from Left</p>  </div> <div style="text-align: center;"> <p>Maintained</p>  </div> <div style="text-align: center;"> <p>Spring Return from Right</p>  </div> </div>				
Contact Code	Contact Block		Operator Position			Maintained	Spring Return from Left	Maintained	Spring Return from Right
	Mounting Position	Contact	L	R	C	L C R	L C R	L C R	L C R
11 (1NO-1NC)	1	NO	●			*ASNL111	*ASNL211		
	2	NC			●				
20 (2NO)	1	NO	●			ASNL120-T	ASNL220-T		
	2	NO			●				
22 (2NO-2NC)	1	NO	●			*ASNL122	*ASNL222		
	2	NO			●				
	3	NC	●						
	4	NC			●				
40 (4NO)	1	NO	●			ASN1L40-T	ASN2L40-T		
	2	NO			●				
	3	NO	●						
	4	NO			●				
22 (2NO-2NC)	1	NO	●			ASN1L5S ★	ASN2L5S ★		
	2	NO			●				
	3	NC	■	■					
	4	NC	■	■					
02 (2NC)	1	NC	■	■		ASN1L7S ★	ASN2L7S ★		
	2	NC	■	■					
04 (4NC)	1	NC	■	■		ASN1L8S ★	ASN2L8S ★		
	2	NC	■	■					
	3	NC	■	■					
	4	NC	■	■					
11 (1NO-1NC)	1	NO	●					*ASN10L11	*ASN20L11
	2	NC	●					—	ASN20L02-T
02 (2NC)	1	NC	●						
	2	NC	●						
	3	NO	●						
	4	NC	●						
22 (2NO-2NC)	1	NO	●						
	2	NO	●						
	3	NO	●						
	4	NC	●						
04 (4NC)	1	NC	●						
	2	NC	●						
	3	NC	●						
	4	NC	●						
22 (2NO-2NC)	1	NO	●						
	2	NO	●						
	3	NC	■	■					
	4	NC	■	■					
02 (2NC)	1	NC	■	■					
	2	NC	■	■					
04 (4NC)	1	NC	■	■					
	2	NC	■	■					
	3	NC	■	■					
	4	NC	■	■					



ASN□-T are twin-rod units. Single rods are available for the same circuit (marked with *) but different contacts are used.

ø30 ø30 Series Selector Switches

ASN□K Key Selector Switches

90° 2-position

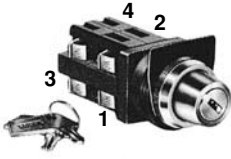
Package Quantity: 1

Shape		ASNK		 <ul style="list-style-type: none"> • Cylinder: Chrome-plated • Round bezel (metal): Chrome-plated • On the spring-returned, the keys can be released only from the maintained position. On the maintained, the key can be released from every position. Key retained positions are also available. See page 21. • Key selector switch is supplied with two standard keys. Two different keys are available upon request. • Part numbers with "-T" differ in shape. • See page 48 for dimensions. • Nameplates are ordered separately. 						
Contact Arrangement Chart										
Contact Code	Contact Block		Operator Position		Maintained	Spring Return from Right	Maintained	Spring Return from Left		
	Mounting Position	Contact	L	R	L R	L R	L R	L R		
10 (1NO)	1	NO		●	ASN3K10-T *ASN3K10	ASN4K10-T *ASN4K10	/	/		
	2	—	—	—						
11 (1NO-1NC)	2	NO		●	ASN3K11-T *ASN3K11	ASN4K11-T *ASN4K11				
	2	NC	●							
20 (2NO)	1	NO		●	ASN3K20-T *ASN3K20	ASN4K20-T *ASN4K20				
	2	NO		●						
22 (2NO-2NC)	1	NO		●	ASN3K22-T *ASN3K22	ASN4K22-T *ASN4K22				
	2	NC	●							
	3	NO		●						
	4	NC	●							
7S (1NO-1NC)	1	NO	■		ASN3K7S-T *ASN3K7S (Note)	ASN4K7S-T *ASN4K7S (Note)				
	2	NC	■							
10 (1NO)	1	NO	●		/	/			*ASN30K10	*ASN40K10
	2	—	—	—						
01 (1NC)	1	NC	●				—	ASN40K01-T		
	2	—	—	—						
11 (1NO-1NC)	1	NO	●				*ASN30K11	ASN40K11-T *ASN40K11		
	2	NO		●						
20 (2NO)	1	NC	●				*ASN30K20	ASN40K20		
	2	NC	●				—	ASN40K02-T		
02 (2NC)	1	NC	●				/	/		
	2	NC	●							
22 (2NO-2NC)	1	NC	●						*ASN30K22	ASN40K22-T *ASN40K22
	2	NO		●						
	3	NC	●							
	4	NO		●						
7S (1NO-1NC)	1	NO	■		*ASN30K7S (Note)	ASN40K7S-T *ASN40K7S (Note)				
	2	NC	■							



Note: The overlapping time is shorter for left to right than right to left. Take overlapping time into consideration.

ø30 Series Selector Switches ø30

ASNK Key Selector Switches

45° 3-position

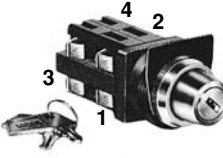
Package Quantity: 1

Shape		ASN□K		 <ul style="list-style-type: none"> • Cylinder: Chrome-plated • Round bezel (metal): Chrome-plated • On the spring-returned types, the keys can be released only from the maintained position. On the maintained types, the key can be released from every position. Key retained positions are also available. See page 21. • Key selector switch is supplied with two standard keys. Two different keys are available upon request. • See page 48 for dimensions. • Nameplates are ordered separately. 					
Contact Arrangement Chart									
Contact Code	Contact Block		Operator Position			Maintained	Spring Return from Left	Maintained	Spring Return from Right
	Mounting Position	Contact	L	C	R	L C R	L C R	L C R	L C R
11 (1NO-1NC)	1	NO	●			*ASN1K11	*ASN2K11		
	2	NC			●				
20 (2NO)	1	NO	●			ASN1K20-T	ASN2K20-T		
	2	NO			●				
22 (2NO-2NC)	1	NO	●			*ASN1K22	*ASN2K22		
	2	NC			●				
	3	NO	●						
	4	NC			●				
40 (2NO)	1	NO	●			ASN1K40-T	ASN2K40-T		
	2	NO			●				
	3	NO	●						
	4	NO			●				
5S (2NO-2NC)	1	NO	●			*ASN1K5S	*ASN2K5S		
	2	NC			●				
	3	NO	■	■					
	4	NC	■	■					
5S (2NO-2NC)	1	NO	●			ASN1K5S-T	ASN2K5S-T		
	2	NO			●				
	3	NC	■	■					
	4	NC	■	■					
7S (2NC)	1	NO	■	■		*ASN1K7S	*ASN2K7S		
	2	NC	■	■		ASN1K7S-T	ASN2K7S-T		
8S (4NC)	1	NO	■	■		*ASN1K8S	*ASN2K8S		
	2	NC	■	■					
	3	NO	■	■					
	4	NC	■	■					
8S (4NC)	1	NO	■	■		ASN1K8S-T	ASN2K8S-T		
	2	NC	■	■					
	3	NC	■	■					
	4	NC	■	■					
11 (1NO-1NC)	1	NO			●			*ASN10K11	*ASN20K11
	2	NC	●					—	ASN20K02-T
20 (2NC)	1	NC	●						
	2	NC			●				
22 (2NO-2NC)	1	NO			●			*ASN10K22	*ASN20K22
	2	NC	●						
	3	NO			●				
	4	NC	●						
04 (4NC)	1	NC			●			—	ASN20K04-T
	2	NC	●						
	3	NC			●				
	4	NC	●						
5S (2NO-2NC)	1	NO			●			*ASN10K5S	*ASN20K5S
	2	NC	●						
	3	NO	■	■					
	4	NC	■	■					
5S (2NO-2NC)	1	NO			●			—	ASN20K5S-T
	2	NO	●						
	3	NC	■	■					
	4	NC	■	■					
7S (2NC)	1	NO	■	■				*ASN10K7S	*ASN20K7S
	2	NC	■	■					
7S (2NC)	1	NC	■	■				—	ASN20K7S-T
	2	NC	■	■					
8S (4NC)	1	NO	■	■		*ASN10K8S	*ASN20K8S		
	2	NC	■	■					
	3	NO	■	■					
	4	NC	■	■					
8S (4NC)	1	NC	■	■		—	ASN20K8S-T		
	2	NC	■	■					
	3	NC	■	■					
	4	NC	■	■					

ASN-T are twin-rod units. Single rods are available for the same circuit (marked with *) but different contacts are used.

ø30 ø30 Series Selector Switches

Dimensions

Knob Operator

Dimensions of knob operator marked with ★ or "-T" in the Part No.

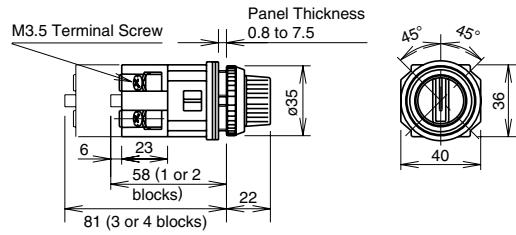
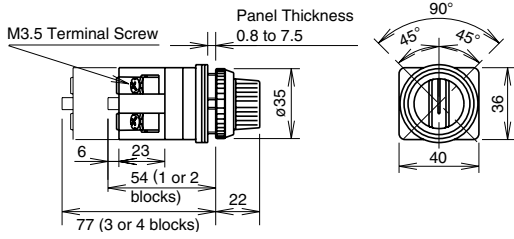

Lever Operator

Dimensions of lever operator marked with ★ or "-T" in the Part No.

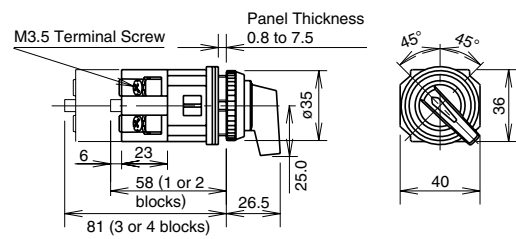
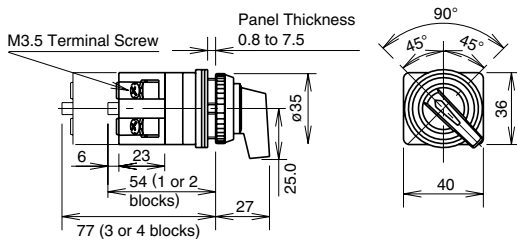

Key Selector

Dimensions of key selector switches marked with "-T" in the Part No.

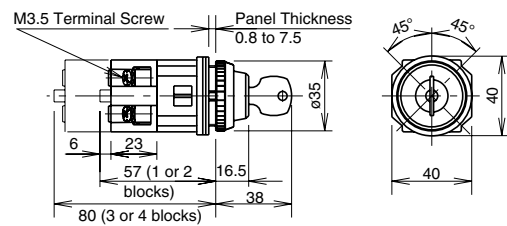
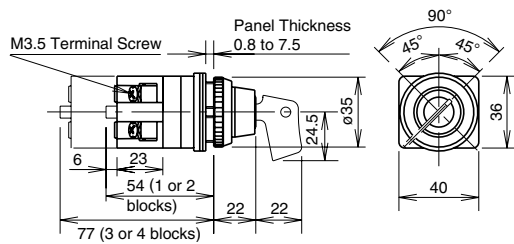

All dimensions in mm.

Contact Block Mounting Position and Contact Arrangement Chart

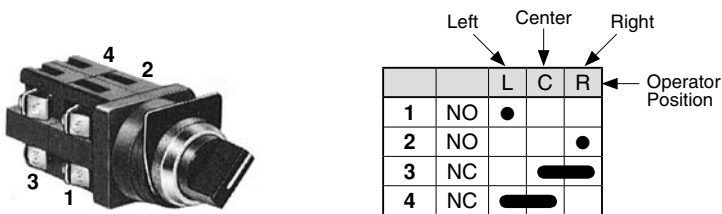

ø30 Series Selector Switches ø30

ASTN Selector Switches (Knob Operator)

Package Quantity: 1

No. of Positions	Shape		ASTN		<ul style="list-style-type: none"> • Knob operator: Black • Round bezel (metal): Chrome-plated 					
	Contact Arrangement Chart									
90° 2-position	Contact Code	Contact Block		Operator Position		Maintained	Spring Return from Right	—	—	
		Mounting Position	Contact	L	R			—	—	
	11 (1NO-1NC)	1	NO		●	ASTN3211	ASTN4211	—	—	
		2	NC	●						
	22 (2NO-2NC)	1	NO		●	ASTN3222	ASTN4222	—	—	
		2	NO		●					
3		NC	●							
4		NC	●							
45° 3-position	Contact Code	Contact Block		Operator Position			Maintained	Spring Return from Left	Spring Return from Right	Spring Return Two-way
		Mounting Position	Contact	L	C	R				
	20 (2NO)	1	NO	●			—	—	—	ASTN5120
		2	NO			●				
	22 (2NO-2NC)	1	NO	●			ASTN1122	ASTN2122	ASTN20122	ASTN5122
		2	NO			●				
		3	NC		■					
		4	NC		■					
	22 (2NO-2NC)	1	NO	●			ASTN1222	ASTN2222	ASTN20222	ASTN5222
		2	NO			●				
		3	NC		■					
		4	NC		■					
	40 (4NC)	1	NO	●			ASTN1340	—	—	—
		2	NO			●				
		3	NO	●						
		4	NO			●				
	22 (2NO-2NC)	1	NO	●			ASTN1422	—	ASTN20422	—
		2	NC		■					
		3	NC		■					
		4	NO			●				
	20 (2NO)	1	NO			●	ASTN1520	—	ASTN20520	—
		2	NO	●						
	40 (4NO)	1	NO	●			ASTN1540	—	ASTN20540	—
		2	NO			●				
		3	NO	●						
		4	NO			●				
	11 (1NO-1NC)	1	NC		●		ASTN1611	—	—	—
		2	NO			●				
22 (2NO-2NC)	1	NC		●		ASTN1622	—	—	—	
	2	NO			●					
	3	NC		●						
	4	NO			●					
11 (1NO-1NC)	1	NO	●			—	—	—	ASTN5111	
	2	NC		■						

Notes:

1. The operator of the 2-way spring return unit may slightly deviate from the center position.
2. Turn the operator to each position accurately.

Contact Block Mounting Position and Contact Arrangement Chart



		Left	Center	Right	Operator Position
		L	C	R	
1	NO	●			
2	NO			●	
3	NC		■		
4	NC	■			



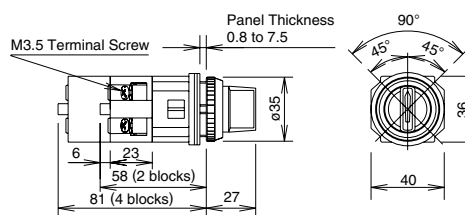



Dimensions



ø30 ø30 series Selector Switches

ASTN□L Selector Switches (Lever Operator)

Package Quantity: 1

No. of Positions	Shape		ASTN□L		<ul style="list-style-type: none"> Lever operator: Black Round bezel (metal): Chrome-plated 					
	Contact Arrangement Chart									
90° 2-position	Contact Code	Contact Block		Operator Position		Maintained	Spring Return from Right	—	—	
		Mounting Position	Contact	L	R			—	—	
	11 (1NO-1NC)	1	NO	●	●	ASTN32L11	ASTN42L11	—	—	
		2	NC	●						
	22 (2NO-2NC)	1	NO	●	●	ASTN32L22	ASTN42L22	—	—	
		2	NO		●					
3		NC	●							
45° 3-position	Contact Code	Contact Block		Operator Position			Maintained	Spring Return from Left	Spring Return from Right	Spring Return Two-way
		Mounting Position	Contact	L	C	R				
	20 (2NO)	1	NO	●			—	—	—	ASTN51L20
		2	NO			●				
22 (2NO-2NC)	1	NO	●			ASTN11L22	ASTN21L22	ASTN201L22	ASTN51L22	
	2	NO			●					
	3	NC			●					
	4	NC			●					
22 (2NO-2NC)	1	NO	●			ASTN12L22	ASTN22L22	ASTN202L22	ASTN52L22	
	2	NO			●					
	3	NC			●					
	4	NC			●					
40 (4NC)	1	NO	●			ASTN13L40	—	—	—	
	2	NO			●					
	3	NO	●							
	4	NO			●					
22 (2NO-2NC)	1	NO	●			ASTN14L22	—	ASTN204L22	—	
	2	NC			●					
	3	NC			●					
	4	NO			●					
20 (2NO)	1	NO	●			ASTN15L20	—	ASTN205L20	—	
	2	NO			●					
40 (4NO)	1	NO	●			ASTN15L40	—	ASTN205L40	—	
	2	NO			●					
	3	NO	●							
	4	NO			●					
11 (1NO-1NC)	1	NC			●	ASTN16L11	—	—	—	
	2	NO			●					
22 (2NO-2NC)	1	NC			●	ASTN16L22	—	—	—	
	2	NO			●					
	3	NC			●					
	4	NO			●					
11 (1NO-1NC)	1	NO	●			—	—	—	ASTN51L11	
	2	NC			●					

Notes:

1. The operator of the 2-way spring return unit may slightly deviate from the center position.
2. Turn the operator to each position accurately.

Contact Block Mounting Position and Contact Arrangement Chart



		Left	Center	Right	Operator Position
		L	C	R	
1	NO	●			
2	NO			●	
3	NC			●	
4	NC			●	



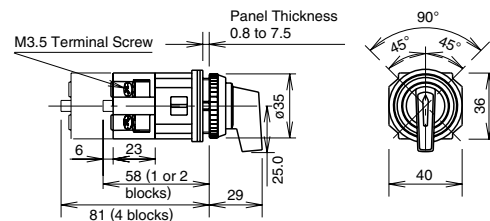







Dimensions



ø30 Series Selector Switches ø30

ASTN□K Key Selector Switches

Package Quantity: 1

No. of Positions	Shape		ASTNK		 <ul style="list-style-type: none"> • Cylinder: Chrome-plated • Round bezel (metal): Chrome-plated • On the spring-returned, the keys can be released only from the maintained position. • On the maintained, the key can be released from every position. Key retained positions are also available. See page 21. 					
	Contact Arrangement Chart				   					
90° 2-position	Contact Code (ASTN)	Contact Block		Operator Position		Maintained	Spring Return from Right	—	—	
		Mounting Position	Contact	L	R			—	—	
	11 (1NO-1NC)	1	NO		●	ASTN32K11	ASTN42K11	—	—	
		2	NC	●						
	22 (2NO-2NC)	1	NO		●	ASTN32K22	ASTN42K22	—	—	
		2	NO		●					
3		NC	●							
4		NC	●							
45° 3-position	Contact Code (ASTN)	Contact Block		Operator Position			Maintained	Spring Return from Left	Spring Return from Right	Spring Return Two-way
		Mounting Position	Contact	L	C	R				
	20 (2NO)	1	NO	●			—	—	—	ASTN51K20
		2	NO			●				
	22 (2NO-2NC)	1	NO	●			ASTN11K22	ASTN21K22	ASTN201K22	ASTN51K22
		2	NO			●				
		3	NC		■					
		4	NC		■					
	22 (2NO-2NC)	1	NO	●		●	ASTN12K22	ASTN22K22	ASTN202K22	ASTN52K22
		2	NO			●				
		3	NC		■					
		4	NC		■					
	40 (4NC)	1	NO	●		●	ASTN13K40	—	—	—
		2	NO			●				
		3	NO	●						
		4	NO			●				
	22 (2NO-2NC)	1	NO	●			ASTN14K22	—	ASTN204K22	—
		2	NC		■					
		3	NC		■					
		4	NO			●				
	20 (2NO)	1	NO			●	ASTN15K20	—	ASTN205K20	—
		2	NO	●						
	40 (4NO)	1	NO			●	ASTN15K40	—	ASTN205K40	—
		2	NO	●						
3		NO			●					
4		NO	●							
11 (1NO-1NC)	1	NC		●	●	ASTN16K11	—	—	—	
	2	NO			●					
22 (2NO-2NC)	1	NC		●		ASTN16K22	—	—	—	
	2	NO			●					
	3	NC		■						
	4	NO			●					
11 (1NO-1NC)	1	NO	●			—	—	—	ASTN51K11	
	2	NC		■						

Notes:

1. The operator of the 2-way spring return unit may slightly deviate from the center position.
2. Turn the operator to each position accurately.

Contact Block Mounting Position and Contact Arrangement Chart

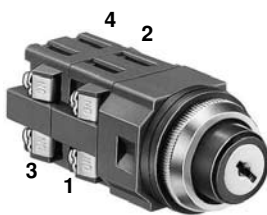

	Left	Center	Right	Operator Position
	L	C	R	
1	NO	●		
2	NO		●	
3	NC		■	
4	NC		■	

Dimensions

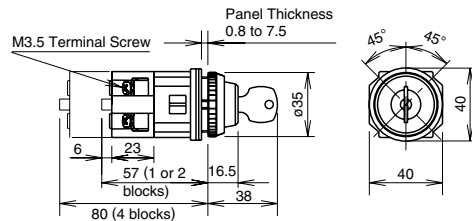



ø30 ø30 series Illuminated Selector Switches

ASLN Illuminated Selector Switches

90° 2-position

Package Quantity: 1

Shape		ASLN (Base BA9S)						
Contact Arrangement Chart		 						
Contact Code	Contact Block		Operator Position		Lamp	Maintained	Spring Return from Right	Spring Return from Left
	Mounting Position	Contact	L	R		L R	L R	L R
11 (1NO-1NC)	1	NO		●	Without Lamp	ASLN29911N②	ASLN219911N②	ASLN229911N② *
	2	NC	●		LED	ASLN2③11DN②	ASLN21③11DN②	ASLN22③11DN② *
					Incandescent	ASLN2③11N②	ASLN21③11N②	ASLN22③11N② *
20 (2NO)	1	NO		●	Without Lamp	ASLN29920N②	ASLN219920N②	ASLN229920N② *
	2	NO		●	LED	ASLN2③20DN②	ASLN21③20DN②	ASLN22③20DN② *
					Incandescent	ASLN2③20N②	ASLN21③20N②	ASLN22③20N② *
22 (2NO-2NC)	1	NO		●	Without Lamp	ASLN29922N②	ASLN219922N②	ASLN229922N② *
	2	NC	●					
	3	NO		●	LED	ASLN2③22DN②	ASLN21③22DN②	ASLN22③22DN② *
	4	NC	●					
				Incandescent	ASLN2③22N②	ASLN21③22N②	ASLN22③22N② *	

Color Code and Operating Voltage Code

Specify a code in place of ② or ③ in the Part No.

② Lens/LED Color Code		③ Operating Voltage Code		Input
LED	Incandescent	LED	Incandescent	
A: amber G: green R: red S: blue W: white Y: yellow	A: amber G: green R: red S: blue W: white	66: 6V AC/DC 11: 12V AC/DC 22: 24V AC/DC	66: 6V AC/DC 88: 12V AC/DC 33: 24V AC/DC	Full voltage
Use a pure white LED lamp for yellow illumination		16: 100/110V AC 156: 115V AC 136: 120V AC 26: 200/220V AC 236: 230V AC 256: 240V AC 386: 380V AC 46: 400/440V AC	16: 100/110V AC 156: 115V AC 136: 120V AC 26: 200/220V AC 236: 230V AC 256: 240V AC 386: 380V AC 46: 400/440V AC 486: 480V AC	Transformer

On the 2-position selector switches marked with * above, the contact operation is reversed as follows.

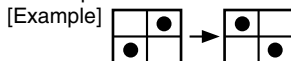

Contact Block Mounting Position and Contact Arrangement Chart

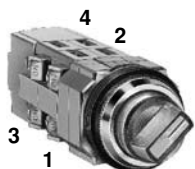

		Left	Right	Operator Position
		L	R	
1	NO		●	
2	NO	●		
3	NC		●	
4	NC	●		

Dimensions

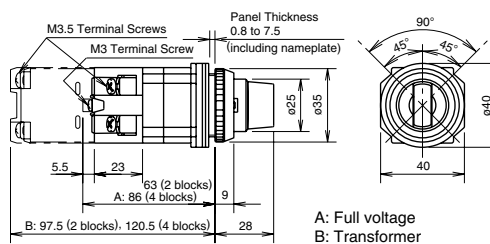

ø30 Series Illuminated Selector Switches ø30

ASLN Illuminated Selector Switches

45° 3-position

Package Quantity: 1

Contact Code	Contact Block		Operator Position			Lamp	Maintained	Spring Return from Right	Spring Return from left	Spring Return Two-way
	Mounting Position	Contact	L	C	R		L C R	L C R	L C R	L C R
20 (2NO)	1	NO	●			Without Lamp	ASLN39920N②	ASLN319920N②	ASLN329920N②	ASLN339920N②
	2	NO			●	LED	ASLN3③20DN②	ASLN31③20DN②	ASLN32③20DN②	ASLN33③20DN②
						Incandescent	ASLN3③20N②	ASLN31③20N②	ASLN32③20N②	ASLN33③20N②
02 (2NC)	1	NC		■		Without Lamp	ASLN39902N②	ASLN319902N②	ASLN329902N②	ASLN339902N②
	2	NC	■			LED	ASLN3③02DN②	ASLN31③02DN②	ASLN32③02DN②	ASLN33③02DN②
						Incandescent	ASLN3③02N②	ASLN31③02N②	ASLN32③02N②	ASLN33③02N②
22 (2NO-2NC)	1	NO	●			Without Lamp	ASLN39922N②	ASLN319922N②	ASLN329922N②	ASLN339922N②
	2	NO			●					
	3	NC		■		LED	ASLN3③22DN②	ASLN31③22DN②	ASLN32③22DN②	ASLN33③22DN②
	4	NC	■							
					Incandescent	ASLN3③22N②	ASLN31③22N②	ASLN32③22N②	ASLN33③22N②	
40 (4NO)	1	NO	●			Without Lamp	ASLN39940N②	ASLN319940N②	ASLN329940N②	ASLN339940N②
	2	NO			●					
	3	NO	●			LED	ASLN3③40DN②	ASLN31③40DN②	ASLN32③40DN②	ASLN33③40DN②
	4	NO			●					
					Incandescent	ASLN3③40N②	ASLN31③40N②	ASLN32③40N②	ASLN33③40N②	
04 (4NC)	1	NC		■		Without Lamp	ASLN39904N②	ASLN319904N②	ASLN329904N②	ASLN339904N②
	2	NC	■							
	3	NC		■		LED	ASLN3③04DN②	ASLN31③04DN②	ASLN32③04DN②	ASLN33③04DN②
	4	NC	■							
					Incandescent	ASLN3③04N②	ASLN31③04N②	ASLN32③04N②	ASLN33③04N②	

Color Code and Operating Voltage Code

Specify a code in place of ② or ③ in the Part No.

② Lens/LED Color Code		③ Operating Voltage Code		Input
LED	Incandescent	LED	Incandescent	
A: amber G: green R: red S: blue W: white Y: yellow	A: amber G: green R: red S: blue W: white	66: 6V AC/DC 11: 12V AC/DC 22: 24V AC/DC	66: 6V AC/DC 88: 12V AC/DC 33: 24V AC/DC	Full voltage
Use a pure white LED lamp for yellow illumination		16: 100/110V AC 156: 115V AC 136: 120V AC 26: 200/220V AC 236: 230V AC 256: 240V AC 386: 380V AC 46: 400/440V AC	16: 100/110V AC 156: 115V AC 136: 120V AC 26: 200/220V AC 236: 230V AC 256: 240V AC 386: 380V AC 46: 400/440V AC 486: 480V AC	Transformer

Contact Block Mounting Position and Contact Arrangement Chart

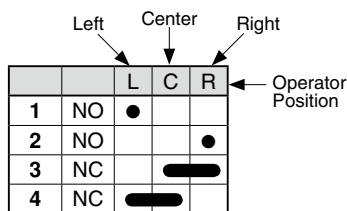

Dimensions

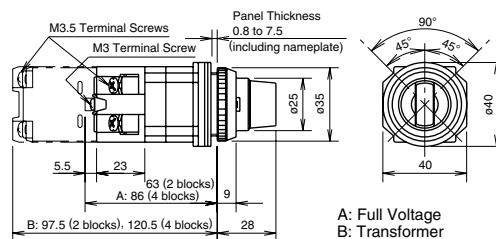

ø30 ø30 Series Selector Pushbuttons

ABN Ring Operator / ABN□L Lever Operator Selector Pushbuttons

Package Quantity: 1

Shape	Contact Code	Circuit Code	Contact Block		Ring/Lever				Ring Operator	Lever Operator	① Button Color Code			
					Pushbutton				Part No.	Part No.				
					Mounting Position	Contact	Normal	Push	Normal	Push				
<p>ABN Ring Operator (90° 2-position) M3.5 Terminal Screw Panel Thickness 0.8 to 7.5 (including nameplate)</p> <p>ABN□L Lever Operator (90° 2-position) M3.5 Terminal Screw Panel Thickness 0.8 to 7.5 (including nameplate)</p>	11 (1NO-1NC)	A	1	NO		●			●	ABN6111①	ABN6L111①	B: black G: green R: red Y: yellow		
			2	NC	●						ABN6411①		ABN6L411①	
		I	1	NC	●						ABN9111①		ABN9L111①	
			2	NO		●		■						
		G	1	NO			Blocked			●	ABN6111①		ABN6L111①	
			2	NC	●			●			ABN9111①		ABN9L111①	
	20 (2NO)	D	1	NO		●				ABN7120①				
			2	NO					●					
	22 (2NO-2NC)	B	C	1	NC	●					ABN6122①		ABN6L122①	
				2	NC	●					ABN6222①		ABN6L222①	
				3	NO		●			●				
				4	NO			●		●				
		I	D	E	1	NC	●						ABN6422①	ABN6L422①
					2	NC	●						ABN7122①	ABN7L122①
					3	NO		●		■				
					4	NO			●		■			
D		E	F	1	NC	●					ABN7122①	ABN7L122①		
				2	NC		■		●					
				3	NO			●						
				4	NO					●				
E	F	H	1	NC	●			●		ABN7222①	ABN7L222①			
			2	NC		■					ABN7322①	ABN7L322①		
			3	NO			●				ABN7322①	ABN7L322①		
			4	NO					●		ABN9122①	ABN9L122①		
F	H		1	NC	●			●		ABN9122①	ABN9L122①			
			2	NC	●			●						
			3	NO					●					
			4	NO					●					

- Specify a button color code in place of ① in the Part No.
- Ring/Lever (metal): Chrome-plated

Notes

1. Circuit Codes A, B, C, and I: When the ring or lever operator is turned, the button is pushed in.
2. Circuit Codes E and F: The right and left NC contact blocks on circuit code E or F may overlap each other while turning the ring or lever operator. The NO and NC contact blocks on circuit code F may overlap each other while pressing the button.
3. Circuit Codes G and H: The pushbutton does not operate when the ring or lever operator is turned to the left position.
4. When using the selector pushbutton, do not turn the ring or lever operator with the pushbutton depressed. Otherwise, damage or failure may be caused.

Contact Block Mounting Position and Contact Arrangement Chart

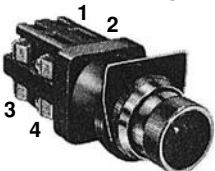

	Normal	Push
1	●	
2	●	
3		●
4		●

Mounting Hole Layout

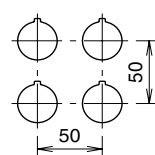

Ring Operator

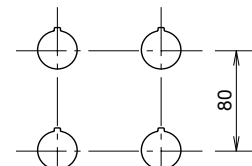

Lever Operator

ø30 ARN/ARNS Series Mono-lever Switches

Single lever offers up to four directions of control

Mono-lever switches operate in four directions using a single lever. Switch contacts are actuated in the direction in which the lever is pushed, enabling quick and accurate control in any desired direction. Ideal for machine tools and industrial machines. The lever action can be maintained or spring-returned in any combination. Also available with interlock mechanism to prevent inadvertent actuation.



Applicable Standards	Mark	File No. or Organization
UL 508		UL Listing File No. E68961
CSA C22.2 No.14		CSA File No. LR21451

Specifications and Ratings

Contact Ratings

Contact Block	BR
Rated Insulation Voltage	600V
Rated Continuous Current	10A
Contact Ratings by Utilization Category IEC 60947-5-1	AC-15 (A600) DC-13 (P600)

Characteristics

Contact Ratings by Utilization Category

Operational Voltage			24V	48V	50V	110V	220V	440V
Operational Current	AC 50/60 Hz	AC-12 Control of resistive loads and solid state loads	10A	—	10A	10A	6A	2A
		AC-15 Control of electromagnetic loads (> 72 VA)	10A	—	7A	5A	3A	1A
	DC	DC-12 Control of resistive loads and solid state loads	10A	5A	—	2.2A	1.1A	—
		DC-13 Control of electromagnets	4A	2A	—	1.1A	0.6A	—

Note: The operational current represents the classification by making and breaking currents (IEC 60947-5-1).

Specifications

Contact Arrangement	Double-break slow action Each contact block contains two independent contacts (2NO, 1NO-1NC, or 2NC) Up to four contact blocks can be mounted
Operating Temperature	-25 to +50°C (no freezing)
Storage Temperature	-35 to +80°C (no freezing)
Operating Humidity	45 to 85% RH (no condensation)
Insulation Resistance	100 MΩ minimum (500V DC megger)
Dielectric Strength	Between live and dead parts: 2,500V AC, 1 minute
Mechanical Life	500,000 operations minimum
Electrical Life	(Interlocking: 250,000 operations minimum)
Lever Knob	Black
Weight (approx.)	276g (ARN4-1111-202020)

BR Contact Block

The contact block is made of nylon resin. Each contact block contains two pairs of double-break silver contacts. There are three types as shown in the diagram below and up to four contact blocks can be mounted in any direction. A wide variety of circuits allows diverse combinations of control.

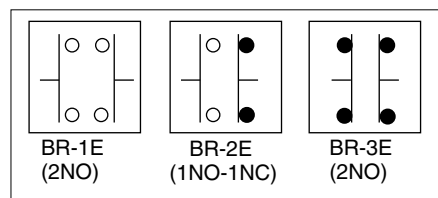





Control Mechanism

When the operator lever is pushed to about 30° in each direction from the neutral position, the contact in that direction activates. The lever can operate in two, three, or four directions, and combinations of maintained or spring-return from any position are possible.

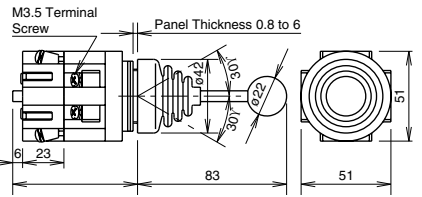
ø30 ARN/ARNS Series Mono-lever Switches

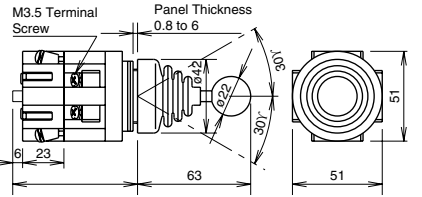
Mono-lever Switches

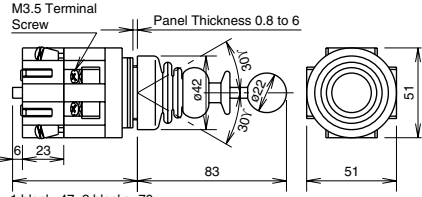
Operator	Position	Lever Action	Part No.	Dimensions (mm)
ARN (Long Lever) 	2-position (Up-Down)	Maintained	ARN2-1010-④B	 <p>M3.5 Terminal Screw Panel Thickness 0.8 to 6</p> <p>1 block: 47, 2 blocks: 70 3 blocks: 93, 4 blocks: 116</p> <p>Minimum horizontal/vertical mounting centers: 110</p>
		Spring return	ARN2-2020-④B	
	2-position (Left-Right)	Maintained	ARN2-0101-④B	
		Spring return	ARN2-0202-④B	
	4-position (Up-Down-Left-Right)	Maintained	ARN4-1111-④B	
		Spring return	ARN4-2222-④B	
ARNS (Short Lever) 	2-position (Up-Down)	Maintained	ARNS2-1010-④B	 <p>M3.5 Terminal Screw Panel Thickness 0.8 to 6</p> <p>1 block: 47, 2 blocks: 70 3 blocks: 93, 4 blocks: 116</p> <p>Minimum horizontal/vertical mounting centers: 70</p>
		Spring return	ARNS2-2020-④B	
	2-position (Left-Right)	Maintained	ARNS2-0101-④B	
		Spring return	ARNS2-0202-④B	
	4-position (Up-Down-Left-Right)	Maintained	ARNS4-1111-④B	
		Spring return	ARNS4-2222-④B	
ARNL (Interlocking)  <p>The operator lever is locked only in the center position.</p>	2-position (Up-Down)	Maintained	ARNL2-1010-④B	 <p>M3.5 Terminal Screw Panel Thickness 0.8 to 6</p> <p>1 block: 47, 2 blocks: 70 3 blocks: 93, 4 blocks: 116</p> <p>Minimum horizontal/vertical mounting centers: 110</p>
		Spring return	ARNL2-2020-④B	
	2-position (Left-Right)	Maintained	ARNL2-0101-④B	
		Spring return	ARNL2-0202-④B	
	4-position (Up-Down-Left-Right)	Maintained	ARNL4-1111-④B	
		Spring return	ARNL4-2222-④B	

- Specify Contact Arrangement from the table below in place of ④.
- Terminal covers are ordered separately.

Lever Operator Position

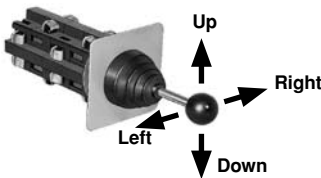

Panel Cut-Out

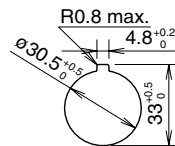

Mono-Lever with Terminal Cover

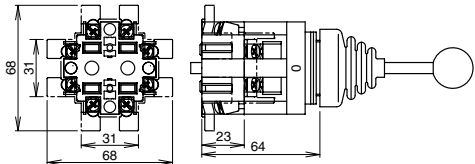

Ordering Information

When ordering, specify items ① to ⑤ according to the following example.

[Example] **ARN** **4** - **1012** - **20 00 02 11** - **B**

Up Right Down Left

① Model	② No. of Contact Blocks	③ Lever Action	④ Contact Arrangement	⑤ Lever Knob Color
ARN ARNS ARNL	1: 1 block 2: 2 blocks 3: 3 blocks 4: 4 blocks	Order of Entry: Up→Right→ Down→Left 1: Maintained 2: Spring return 0: Blocked	Order of Entry: Up→Right→ Down→Left 10: 1NO 01: 1NC 11: 1NO-1NC 20: 2NO 02: 2NC 00: Blocked	B: black







Contact Block Position	Terminal No.	Direction of Lever Operation				Terminal No.	Contact Block Type
		Up	Right	Down	Left		
		Lever Operation Mode 1: Maintained 2: Spring return 0: Blocked					
1	1	NO	0	1	2	BR-2E	
	3	—	—	NC	4		
2	5	—	NO *	—	6	BR-1E	
	7	—	—	NO	8		
3	9	NO	—	—	10	BR-2E	
	11	—	—	NC	12		
4	13	—	NC *	—	14	BR-3E	
	15	—	—	NC	16		

- To calculate the number of contact blocks required, add the number of NO and NC contacts on each pair of adjoining positions (up + right, right + down, down + left, and left + up). The largest of the four sums is the number of contact blocks required. Up to four contact blocks can be mounted.
- When UL and CSA markings are required on the mono-lever switch, specify as shown below.
[Example] ARN4-1012-20000211-B-**U**

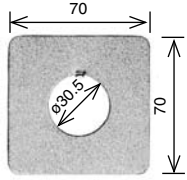
*: Contacts marked with * do not operate.

ARN/ARNS Series Accessories and Replacement Parts ø30

Accessories and Maintenance Parts

Shape	Specification	Part No.	Ordering No.	Package Quantity	Description
Nameplate		MLO	MLO	1	Chrome-plated brass (matte surface)
			MLOPN10	10	
Terminal Cover		ARN-VL2	ARN-VL2	1	<ul style="list-style-type: none"> Terminal covers are ordered separately. When ordering, specify the Part No. and the required quantity. Order 2 pieces for each contact block.
Contact Block (BR)		BR-1E	BR-1E	1	• 2NO contact
		BR-2E	BR-2E	1	• 1NO-1NC contact
		BR-3E	BR-3E	1	• 2NC contact
Bellows		ARN-BL	ARN-BL	1	• For ARN/ARNS (Locking ring not included)
Bellows (Interlocking)		ARNL-BL	ARNL-BL	1	• For ARNL (Locking ring not included)
Knob		ARNB-①	ARNB-①	1	Specify a color code in place of ①. B (black), G (green), R (red) • For ARN/ARNS

ø30/ø25 CS Series Cam Switches

71 standard circuits to choose from

- Wide variety of heavy-duty oiltight cam switches
- Operators available up to 12 positions
- Contact blocks rated at 600V, 10A
- Ideal for ammeter/voltmeter applications
- UL listed and CSA approved



Specifications and Ratings

Contact Ratings

Rated Insulation Voltage	600V
Rated Continuous Current	10A
Contact Ratings by Utilization Category IEC 60947-5-1	AC-15 (A600) DC-13 (P600)

Characteristics

Contact Ratings by Utilization Category

Operational Voltage		24V	110V	220V	440V	
Operational Current	AC 50/60 Hz	AC-12 Control of resistive loads and solid state loads	—	10A	6A	2A
		AC-15 Control of electromagnetic loads (> 72 VA)	—	5A	3A	1A
	DC	DC-12 Control of resistive loads and solid state loads	8A	3A	1A	0.4A
		DC-13 Control of electromagnets	5A	1.2A	0.45A	0.2A

Note: The operational current represents the classification by making and breaking currents (IEC 60947-5-1).

Specifications

Contact Arrangement	Double-break slow action contacts Two contacts in one deck Up to 6 decks available (Spring-return: Up to 3 decks)	
Operation	Maintained	Spring return
Angle	30°, 45°, 60°, 90°	45°
Operator Positions	2 to 12	2, 3, 4
Operating Temperature	-20 to +50°C (no freezing)	
Storage Temperature	-40 to +80°C (no freezing)	
Operating Humidity	45 to +85% RH (no condensation)	
Insulation Resistance	100 MΩ (500V DC megger)	
Dielectric Strength	2500V AC, 1 minute (between live and dead parts)	
Mechanical Life	1 to 3 decks: 500,000 operations 4 to 6 decks: 200,000 operations	
Electrical Life	200,000 operations minimum	
Degree of Protection	ACSNO, ACSSO: IP65 (IEC 60529) ACSNK, ACSSK: IP54 (IEC 60529) UCS: IP40 (IEC 60529)	
Weight (approx.)	319g (ACSNO-663-S2B)	

CSB Contact Block

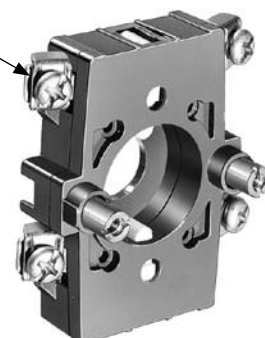

The CSB contact block contains two poles of double-break contacts. The contacts are operated by a cam designed to perform a required contact operation. Up to six contact blocks can be mounted on a maintained-action operator base, and up to three contact blocks on a spring return operator base.

M3.5 Screw Terminal

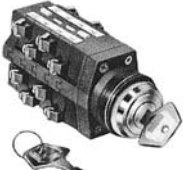
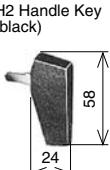

CS Series Cam Switches **ø30/ø25**

Cam Switches

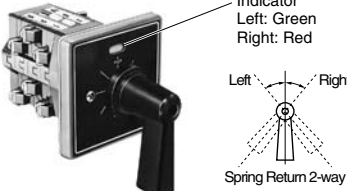
① Model		② Contact Block Decks	③ Positions	④ Angle	⑤ Spring Return	⑥ Handle	⑦ Contact Arrangement	Nameplate
ø30 Series	ø25 Series							
ACSNO	ACSSO	Maintained: 1 to 6 decks Spring return: 1 to 3 decks	Maintained: 2 to 12 positions Spring return: 2 to 4 positions	Maintained: 30°, 45°, 60°, 90° Spring return: 45° only	Spring return from right Spring return from left Spring return two-way	Y2, S2, P2, F2, 25S2 (25S2 is for ACSSO only) (one specified handle supplied)	See page 69. (ordered separately)	
 (Photo: ACSNO with Y2 handle)	ACSSK							
ACS NK	ACSSK	Maintained: 1 to 6 decks Spring return: 1 to 3 decks	Maintained: 2 to 8 positions Spring return: 2 to 4 positions	Maintained: 45°, 90° Spring return: 45° only	Spring return from right Spring return from left Spring return two-way	Two standard keys are supplied. When the H2 key handle is required, specify H2.	See page 63 to 65.	
 Standard Key (2 keys supplied)								
UCSQO	(Enclosed)	Maintained: 1 to 6 decks Spring return: 1 to 3 decks	Maintained: 2 to 12 positions Spring return: 2 to 4 positions	Maintained: 30°, 45°, 60°, 90° Spring return: 45° only	Spring return from right Spring return from left Spring return two-way	Y2, S2, F2, P2 (one specified handle supplied)	Type CQ See page 68.	
 (Photo: With Y2 handle)	(Enclosed)							
UCSQM	(Enclosed)	Spring return: 1 to 3 decks	Spring return: 3 positions	Spring return: 45° only	Spring return two-way		C1007 C1008 C1009 C1010 C1018 C2006 C2007 C2021 See page 63 to 65.	Type CQM See page 68.
	Indicator Left: Green Right: Red Left Right Spring Return 2-way							

• For handles and accessories, see page 60 and 61.

Dimensions

ACSNO/ACSSO

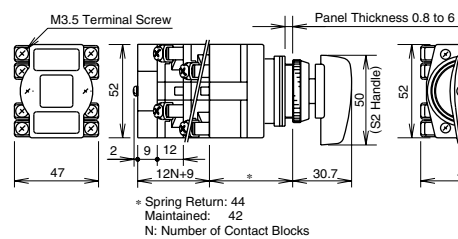

ACS NK/ACSSK

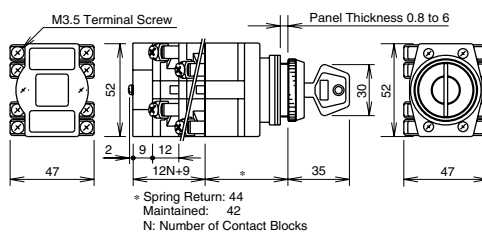

Panel Cut-out

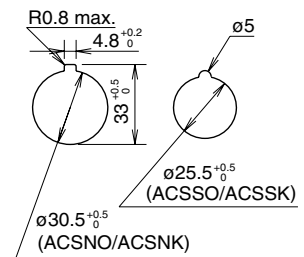

• Minimum horizontal/vertical mounting centers
With P2 handle: 125
With other handles: 70

UCSQO

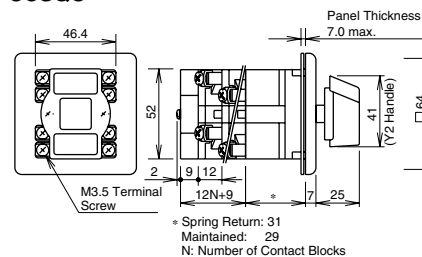

UCSQM

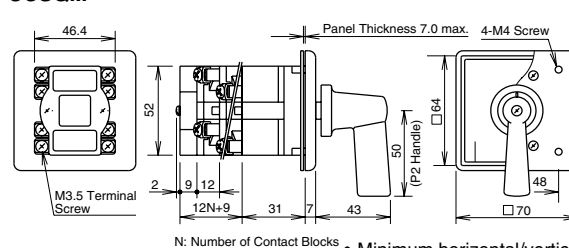

Panel Cut-out

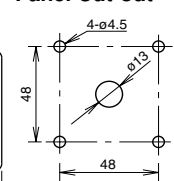

• Minimum horizontal/vertical mounting centers
With P2 handle: 125
With other handles: 70

All dimensions in mm.

ø30/ø25 CS Series Cam Switches

Ordering Information

When ordering, specify items ① through ⑦ as the designation example below.

①	②		③		④		⑤		⑥	⑦
Model	Decks	Code	Positions	Code	Angle	Code	Return	Code	Handle	Circuit No.
ACSNO	1 deck	1	2 positions	2	30°	3	Spring return	RO	(Code) Y2, S2, P2, F2, H2, 25S2 (Color) B: Black See table below. 25S2 is for ACSSO only.	For standard contact arrangements, use designation code on pages 63 to 65. For custom contact arrangements, use the Custom Contact Arrangement Specifica- tion Sheet on page 66.
ACSNK	2 decks	2	3 positions	3	45°	4	from left			
ACSSO	3 decks	3	4 positions	4	60°	6	Spring return	OR		
ACSSK	4 decks	4	5 positions	5	90°	9	from right			
UCSQO	5 decks	5	6 positions	6			Spring return	RR		
UCSQM	6 decks	6	7 positions	7			two-way			
			8 positions	8						
			9 positions	9						
			10 positions	10						
			11 positions	11						
			12 positions	12						
	Spring return: 1 to 3 decks only		Spring return: 2 to 4 positions only		ACSNO/ACSSK: 45° and 90° only Spring return: 45° only		Spring return code is required only for spring return.			



Designation Example

UCSQO - 2 3 4 RR - S2B - C2006

① ②③④ ⑤ ⑥ ⑦

- When a special contact arrangement is required, specify the contact arrangement using the Custom Contact Arrangement Specification Sheet on page 66.
- A specified handle is attached.
- Accessories such as nameplates and jumpers are separately ordered.
- The key of the key operated cam switch is removable from every position. Specify other key removable configurations if required.

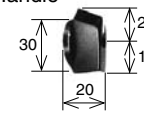
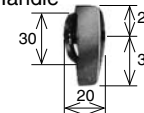
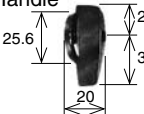
Handle Designation Code

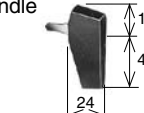
Shape	Code	Color	Applicable Cam Switch
 ø30 Y Handle	Y2	B: black	ACSNO UCSQO UCSQM
 ø30 S Handle	S2		
 ø25 S Handle	25S2		
 ø30 P Handle	P2		ACSNO UCSQO UCSQM
 ø30 F Handle	F2		
 Key Handle	H2		ACSNK ACSSK

Spring Return Operation

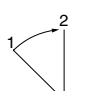
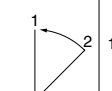
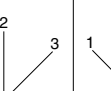
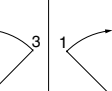
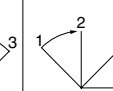
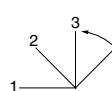
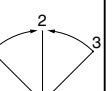
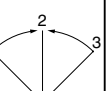

Available combinations of operator positions, angles, and return directions are listed in the table below.



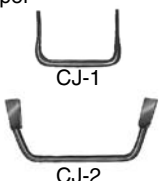

Positions	2-position		3-position			4-position		3-position
	From Left	From Right	From Left	From Right	Two-way	From Left	From Right	Two-way
Return Direction								
③ ④ ⑤ Codes	24RO	24OR	34RO	34OR	34RR	44RO	44OR	34RR
Applicable Cam Switches	ACSNO, ACSSO, ACSNK, ACSSK, UCSQO							UCSQM
Contact Block Decks	1 to 3 decks							

Note: Maintained do not require spring return code ⑤.

CS Series Accessories and Replacement Parts ø30/ø25

Accessories and Replacement Parts

Shape	Material	Part No.	Ordering No.	Package Quantity	Remarks
Jumper  CJ-1 CJ-2	Metal (copper)	CJ-1	CJ-1PN10	10	For connecting terminals of adjoining contact blocks
		CJ-2	CJ-2PN10	10	For connecting terminals of the same contact block
Rubber Boot 	Rubber (nitril)	CR-1	CR-1	1	For preventing ingress of dust into the contact blocks Not applicable for the UCSQO and UCSQM
Terminal Cover  CS-VL2-13S CS-VL2-46S <small>Supplied with 2 self-tapping screws for mounting</small>	Plastic (PPE)	CS-VL2-13S	CS-VL2-13S	1	For 1 to 3 decks of contact blocks
		CS-VL2-46S	CS-VL2-46S	1	For 4 to 6 decks of contact blocks

Shape	Material (Color)	Part No.	Ordering No.	Package Quantity
ø30 Y Handle 	Plastic (Black)	CSH-YB	CSH-YB	1
ø30 S Handle 	Plastic (Black)	CSH-SB	CSH-SB	1
ø25 S Handle 	Plastic (Black)	CSH-25SB	CSH-25SB	1
ø30 P Handle 	Plastic (Black)	CSH-PB	CSH-PB	1
ø30 F Handle 	Plastic (Black)	CSH-FB	CSH-FB	1
Key Handle 	Plastic (Black)	CSH-H2B	CSH-H2B	1
Spare Keys 	Metal (brass nickel-plated)	CSH-K301	CSH-K301PN02	2
Handle Shaft 	Plastic	CS-HF2C	CS-HF2CPN05	5
Handle Screw 	For Y, ø30 S, and ø25 S handles M3 × 12	CS-SCW-M3-12	CS-SCW-M3-12PN10	10
Handle Screw 	For P and F handles M3 × 25	CS-SCW-M3-25	CS-SCW-M3-25PN10	10

Instructions

Installing the Terminal Cover for the CS series Cam Switches

- Complete wiring before installing the terminal cover on the bottom plate of the contact block.
- The terminal cover has six holes. Of the four round holes at four corners, use two diagonal pair of holes to install the terminal cover. Either pair can be used.
- Insert the attached self-tapping screws into the pair of holes and tighten the screws to a torque of 0.8 to 1.0 N·m.
- For 1 through 3 decks of contact blocks, use terminal cover CS-VL2-13S.
- For 4 through 6 decks of contact blocks, use terminal cover CS-VL2-46S.
- The CS-VL2-46S consists of the CS-VL2-13S and a terminal cover for the fourth through sixth decks. Combine the two parts together as shown. Note that once combined, the two parts cannot be separated.

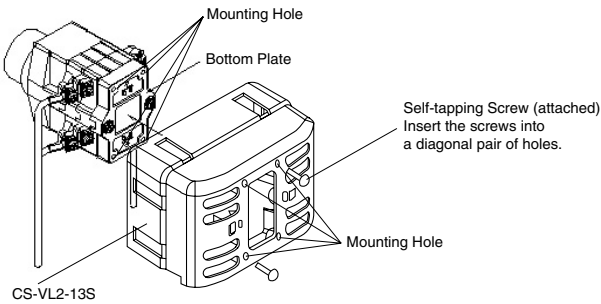

For 1 through 3 decks of contact blocks (CS-VL2-13S)

Minimum Mounting Centers for Installing the Terminal Cover

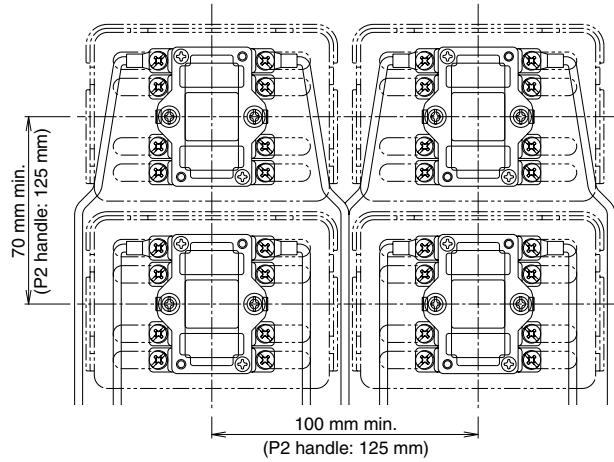

- Although the minimum mounting centers are 100 mm horizontally and 70 mm vertically, determine the mounting centers in consideration of convenience of wiring. For the P2 handle, the minimum mounting centers are 125 mm horizontally and vertically.

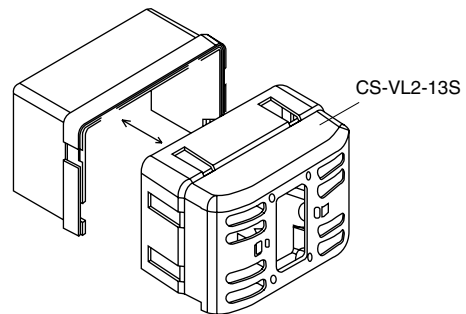

For 4 through 6 decks of contact blocks (CS-VL2-46S)

Terminal Cover Dimensions

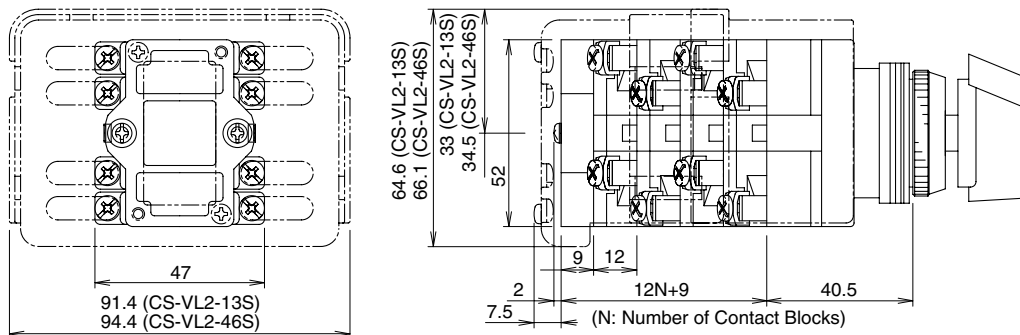

All dimensions in mm.

Standard Contact Arrangements

- The following table lists 76 standard contact arrangements for easy designation of required cam switch operation.
- When other contact arrangements are required, specify the number of contact block decks, operator positions, angles, and contact operation using the Custom Contact Arrangement Specification Sheet on page 66.

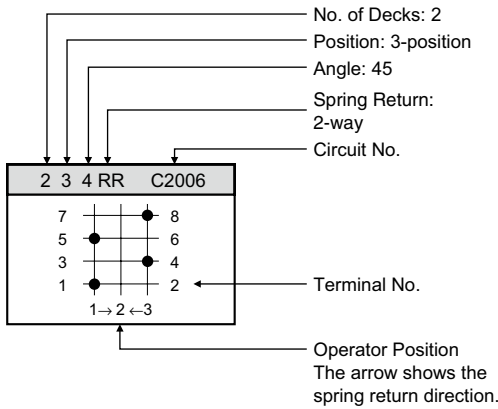

Symbol	Contact Operation
●	Contacts closed.
▬	Contacts remain closed between two operator positions.
▬ ▬	Overlapping Contacts Contacts of different decks are both closed at one point while the handle is turned to the next position.
○●	Residual Contacts When the handle is returned to the center, the contacts remain closed. The contacts are opened when the handle is turned to the opposite direction.

Listing Order of the Table

The 76 standard contact arrangements are listed in the order of the circuit number.

Same Circuits

Shown in the following examples, circuits of Fig. 1 and Fig. 2 have the same functions. When ordering, examine the standard contact arrangements. Your requirements may be satisfied simply by changing external wiring of the standard contact arrangements.

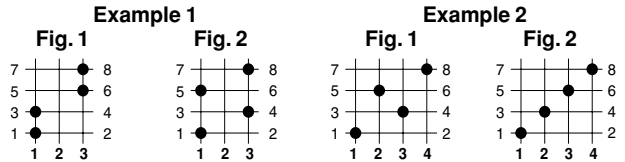

Terminal Numbers

The terminal numbers on the contact blocks correspond with the numbers shown in the chart as shown below.

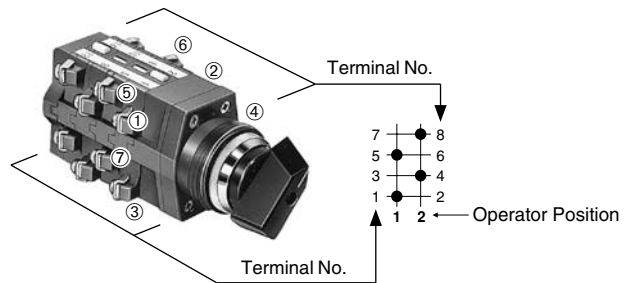

Standard Contact Arrangement Chart				
1 2 9 C1001	1 2 9 C1002	1 2 4 OR C1003	1 2 4 OR C1004	1 3 4 C1005
1 3 4 C1006	1 3 4 RR C1007	1 3 4 RR C1008	1 3 4 RR C1009	1 3 4 RR C1010
1 4 4 C1011	1 2 9 C1013	1 2 9 C1014	1 2 4 OR C1015	1 3 4 C1016
1 2 4 C1017	1 3 4 RR C1018	1 2 6 C1019		
2 2 9 C2001	2 2 9 C2002	2 3 4 C2003	2 3 4 C2004	2 3 4 C2005

ø30/ø25 CS Series Instructions

2 3 4 RR C2006 	2 3 4 RR C2007 	2 4 4 C2008 	2 4 4 C2009 	2 4 9 C2011
2 2 9 C2014 	2 2 9 C2015 	2 3 4 C2016 	2 3 4 C2017 	
2 3 4 C2019 	2 3 4 C2020 	2 3 4 RR C2021 	2 4 4 C2022 	
		2 5 3 C2027 	2 3 6 C2028 	2 3 6 C2029
3 2 9 C3001 	3 3 4 C3002 	3 5 4 C3003 	3 6 4 C3004 	3 3 4 C3005
3 4 9 C3008 	3 4 9 C3009 	3 2 9 C3010 	3 3 4 C3011 	3 4 4 C3012
3 6 3 C3013 	3 3 6 C3014 	3 6 6 C3015 	3 5 3 C3016 	3 4 4 C3017
3 3 6 C3018 		4 4 4 C4001 	4 8 4 C4002 	4 4 9 C4003
4 2 4 C4004 	4 2 9 C4005 	4 2 9 C4006 	4 4 9 C4007 	4 3 4 C4008

CS Series Instructions ø30/ø25

4 5 4 C4009	5 3 4 C5001	6 4 4 C6001	6 12 3 C6002
6 4 9 C6003	6 9 3 C6004	6 6 6 C6005	6 6 4 C6006

Application Examples (Voltmeter and Ammeter Circuits)

1 2 6 C1019 (ammeter switching, 1CT circuit)	2 3 6 C2029 (ammeter switching, 2CT circuit)	2 4 9 C2011 (ammeter switching, 2CT circuit)
2 4 4 C2022 (voltmeter switching, 3PT circuit)	3 4 9 C3008 (voltmeter switching, 2PT circuit)	3 4 9 C3009 (voltmeter switching, 3PT circuit)
6 4 9 C6003 (ammeter switching, 3CT circuit)	4 4 9 C4003 (ammeter switching, 3CT circuit)	4 4 9 C4007 (ammeter switching, 2CT circuit)

Custom Contact Arrangement Specification Sheet

- The preceding pages provide 76 standard contact arrangements. When other contact arrangements are required, specify the number of contact block decks, operator positions, angles, and contact operation using the Custom Contact Arrangement Specification Sheet shown below.
- For available number of contact blocks and operator positions, see the Ordering Information on page 60.

1. Specify operator positions

Indicate the operator positions starting at the first position. When spring return operation is required, mark an arrow between two operator positions to indicate the spring return direction.

Deck 2	7	○	○	○	●	○
	5	○	■	○	○	○
Deck 1	3	○	●	○	○	○
	1	●	○	○	○	○
Angle		↘		↗		
Positions		1	2	3	4	5
Spring Return		→				

2. Specify contact operation at each operator position

Indicate the required operation of all contacts at each operator position using the following symbols.







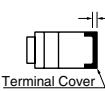

Symbol	Contact Operation
●	Contacts closed.
■	Contacts remain closed between two operator positions.
	Overlapping Contacts Contacts of different decks are both closed at one point while the handle is turned to the next position. Overlapping contacts are not available for handle angles of 30° and 45°.
○...●	Residual Contacts When the handle is returned to the center, the contacts remain closed. The contacts are opened when the handle is turned to the opposite direction.

- One deck of contact block contains two poles of contacts and four terminals. When the handle is made to turn 180° or more, special attention is needed. Since one cam operates the two poles of contacts on opposite positions, the same contact operation repeats on the other pole of contacts when the handle is turned 180°. When different contact operation is needed for handle angles of 180° or more, use another deck of contact block.

CS Series Cam Switch Custom Contact Arrangement Specification Sheet														
Part No.: [] [] [] [] [] [] [] [] [] [] [] []											Quantity: _____			
① Model ② Decks ③ Positions ④ Angle ⑤ Spring Return ⑥ Handle														
Deck	Terminal No.	Contact Arrangement Chart										Terminal No.		
Deck 6	23	○	○	○	○	○	○	○	○	○	○	○	24	
	21	○	○	○	○	○	○	○	○	○	○	○	22	
Deck 5	19	○	○	○	○	○	○	○	○	○	○	○	20	
	17	○	○	○	○	○	○	○	○	○	○	○	18	
Deck 4	15	○	○	○	○	○	○	○	○	○	○	○	16	
	13	○	○	○	○	○	○	○	○	○	○	○	14	
Deck 3	11	○	○	○	○	○	○	○	○	○	○	○	12	
	9	○	○	○	○	○	○	○	○	○	○	○	10	
Deck 2	7	○	○	○	○	○	○	○	○	○	○	○	8	
	5	○	○	○	○	○	○	○	○	○	○	○	6	
Deck 1	3	○	○	○	○	○	○	○	○	○	○	○	4	
	1	○	○	○	○	○	○	○	○	○	○	○	2	
Angle														
Positions		1	2	3	4	5	6	7	8	9	10	11	12	
Spring Return														

ø30 Series Accessories and Replacement Parts ø30

Terminal Covers

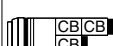
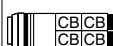
Terminal Cover		N-VL2	N-VL3	N-VL4	APN-PVL	APD-PVL	Use of terminal covers increases the depth by the dimensions below. 
							
ø30 Series Control Unit		38.4H × 22W	38H × 30.4W	38.4H × 24W	38H × 46W	37H × 44W	
Pilot Light APN, APNE, UPQN, UPQNE	Full Voltage				X		+5.0 mm
Pilot Light APD, APDE							X
Pilot Light APN, APNE, APD, APDE, UPQN, UPQNE	Transformer DC-DC Converter		X				+2.7 mm
Pushbutton ABN, ABD, AON, AOD, AVN, ABGD, AJN, ABFD, ATN, AOFD, UBQN, AVD, UOQN, AJD, UWQN, AZD, ABBN, AYD, ABBS (ø25) Selector Switch ASN, ASD, ASTN Selector Pushbutton ABN, ASBD	1 contact block 	X					+0 mm
	2 contact blocks 	X 2 pieces					
	3 contact blocks 	X 2 pieces					
	4 contact blocks 	X 2 pieces					
Illuminated Pushbutton ALN, ALD, ALNE, ALDE, AOLN, AOLD, AOLNE, AOLDE, ALGN, ALGD, ALGNE, ALGDE, AOLGN, AOLGDE, ALFN, ALFD, ALFNE, ALFDE, AOLFN, AOLFDE, AOLFNE, AOLFDE, AVLN, AVLD, AVLNE, AVLDE, AJLN, AJLD, AJLNE, AJLDE, ULQN, UOLQN Illuminated Selector Switch ASLN, ASLD Push-to-Check Pilot Light APN1**P	Full Voltage			X 2 pieces			+4.5 mm
	Transformer DC-DC Converter		X				+1.5 mm

Ordering Terminal Covers

When ordering terminal covers, specify the Part No. and the quantity.

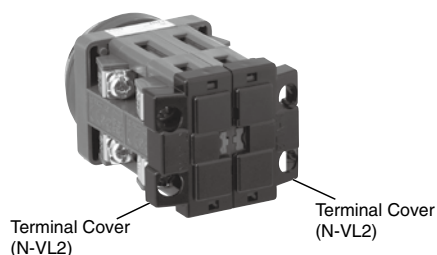

ø30 ø30 series Accessories and Replacement Parts

Nameplates

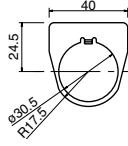
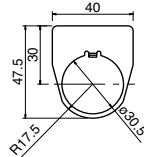
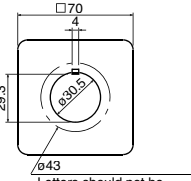
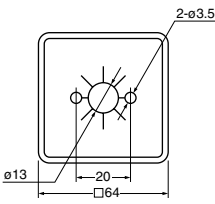
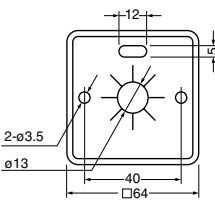
Model	Legend	Material	Part No.	Ordering No.	Package Quantity	Dimensions (mm)	Applicable Unit
NA	Blank	Aluminium 1.2 mm thick White letters on black background	NA-0	NA-0	1		ø30 Control Unit
				NA-0PN10	10		
	With Legend		NA-*	1			
			NA-*PN10	10			
NALO	Blank	Aluminium 1.2 mm thick Black	NALO	NALO	1		
				NALOPN10	10		
MLO	Blank	Brass (chrome-plated) 1.0 mm thick Matte	MLO	MLO	1	 <p>Letters should not be engraved within this line</p>	ARN/ARNS Mono-Lever
				MLOPN10	10		
CQ	Blank	Aluminium 0.5 mm thick White letters on black background	CQ-0	CQ-0	1	<ul style="list-style-type: none"> • With adhesive tapes on the back 	UCSQO Cam Switch
				CQ-0PN10	10		
	With Legend (Legend Codes 31 and 53 only)		CQ-*	1			
			CQ-*PN10	10			
CQM	Blank	Aluminium 0.5 mm thick White letters on black background	CQM-0	CQM-0	1	<ul style="list-style-type: none"> • With adhesive tapes on the back 	UCSQM Cam Switch
				CQM-0PN10	10		
	With Legend (Legend Code 31 only)		CQM-*	1			
			CQM-*PN10	10			

• Specify a legend code in place of * in the Ordering No.

ø30 Series Accessories and Replacement Parts ø30

Nameplates

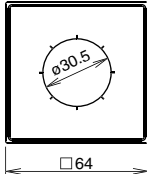
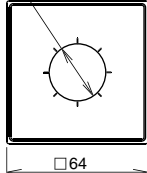
Model	Legend	Material	Part No.	Ordering No.	Package Quantity	Dimensions (mm)	Applicable Unit
CQN	Blank	Aluminium 0.5 mm thick White letters on black background	CQN-0	CQN-0	1	• With adhesive tapes on the back 	ACSNO, ACSNK Cam Switches ø30 mm Selector Switches
				CQN-0PN10	10		
	With Legend (Legend Codes 31, 35, and 53 only)		CQN-*	CQN-*	1		
				CQN-*PN10	10		
CQS	Blank	Aluminium 0.5 mm thick White letters on black background	CQS-0	CQS-0	1	• With adhesive tapes on the back 	ACSSO, ACSSK Cam Switches ø25 mm Selector Switches
				CQS-0PN10	10		
	With Legend (Legend Code 53 only)		CQS-*	CQS-*	1		
				CQS-*PN10	10		

• Specify a legend code in place of * in the Ordering No.

Legends

Code	Legend
0	(blank)
1	ON
2	OFF
3	START
4	STOP
31	OFF-ON
35	HAND-AUTO
53	HAND-OFF-AUTO

Shape and Engraving Area

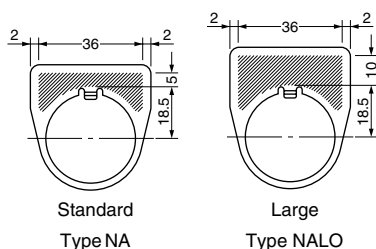











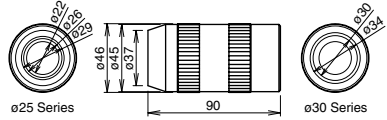

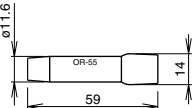

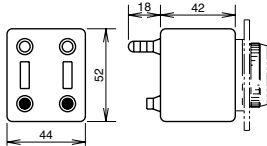
Example

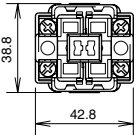
Shape	Engraving Area		Max. No. of Lines	No. of Letters on 1 Line
	Height	Width		
Standard	5	36	1	14
Large	10	36	2	14

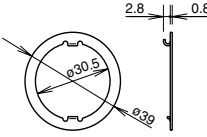
• The above example is when the letter is 4 mm tall.

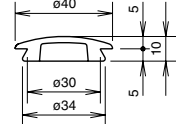

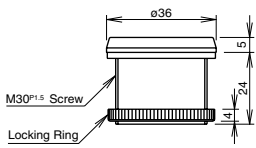

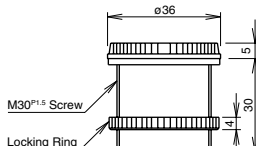



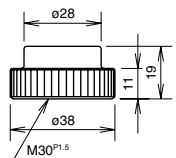

ø30 ø30 series Accessories and Replacement Parts

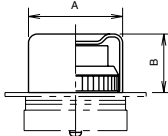
Accessories

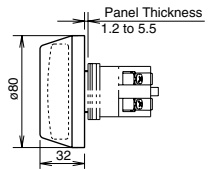
Shape	Material	Part No.	Ordering No.	Package Quantity	Dimensions (mm)
	Rubber	OR-12	OR-12	1	<ul style="list-style-type: none"> Used to tighten the locking ring when installing the ø30 or ø25 switch onto a panel. 
	Rubber	OR-55	OR-55	1	<ul style="list-style-type: none"> Used to install and remove the LED/incandescent lamps. See page 75. 
 <p>For momentary 1 layer of contact blocks (2 contact blocks)</p>	Rubber (nitril) (black)	OC-99	OC-99	1	<ul style="list-style-type: none"> Rubber boot used to prevent oil and dirt from entering into the contact block. Temperature range: -5 to +60°C Cannot be used for zinc diecast control units. 
 <p>For 1 layer of contact blocks (2 contact blocks)</p>	Rubber (translucent)	OC-90	OC-90	1	<ul style="list-style-type: none"> Applicable to AVN3 and AJN3. Applicable to ø30 diecast zinc pushbuttons and selector switches. 
<p>For 2 layers of contact blocks (4 contact blocks)</p>		OC-290	OC-290	1	
	Metal	OGL-11	OGL-11PN10	10	<ul style="list-style-type: none"> Used to prevent the operator from turning. Generally used when using no nameplates on selector switches and selector pushbuttons. 
	Rubber (black)	OB-13B	OB-13BPN05	5	<ul style="list-style-type: none"> Used to plug unused ø30mm mounting holes. Gray also available. Ordering No.: OB-13PN05 
	Plastic (gray)	OBP-11	OBP-11	1	<ul style="list-style-type: none"> Tightening torque: 1.2 N·m. Degree of protection: IP65 
	Metal (diecast) (zinc-plated)	OB-11	OB-11	1	<ul style="list-style-type: none"> Tightening torque: 1.2 N·m. Degree of protection: IP65 

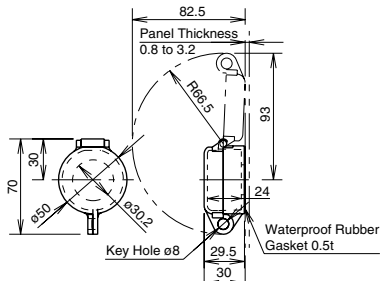

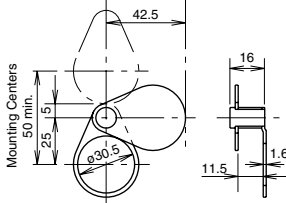

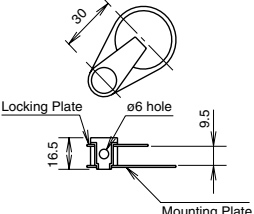

ø30 Series Accessories and Replacement Parts ø30

Accessories

Shape	Material	Part No.	Ordering No.	Package Quantity	Dimensions (mm)									
Button Cover for Extended Pushbuttons 	Rubber (nitril)	Color	Part No.	—	• Metallic bezels covered with a rubber boot to enhance waterproof characteristics. • Button is not included. Applicable to extended pushbuttons only. <div style="text-align: right;">  </div>									
		Black	OC-11B	OC-11B										
		Green	OC-11R	OC-11R										
		Red	OC-11G	OC-11G										
		Yellow	OC-11Y	OC-11Y										
Button Clear Boot 	Rubber (EPDM)	For flush pushbuttons	OC-121	OC-121	• Used to cover and protect pushbuttons where units are subject to water splash. Not suitable for outdoor use or where the units are subject to oil splash. <div style="text-align: right;">  </div>									
For extended pushbuttons		OC-122	OC-122	1										
				<table border="1" style="margin-left: auto; margin-right: auto;"> <thead> <tr> <th></th> <th>A</th> <th>B</th> </tr> </thead> <tbody> <tr> <td>OC-121</td> <td>37</td> <td>16</td> </tr> <tr> <td>OC-122</td> <td>37</td> <td>16</td> </tr> </tbody> </table>			A	B	OC-121	37	16	OC-122	37	16
	A	B												
OC-121	37	16												
OC-122	37	16												
Dust-proof Rubber Cover for Jumbo Mushrooms 	Rubber (nitril) black	OC-4GN	OC-4GN	1	• Used for ABN4G pushbuttons. <div style="text-align: right;">  </div>									
Padlock Cover 	Polyarylate (gasket: nitril rubber)	OL-KL1	OL-KL1	1	• Used to protect pushbuttons, illuminated pushbuttons, and selector switches (knob operator). <div style="text-align: right;">  </div>									
Metal Protector 	Metal (zinc-plated)	OL-C	OL-C	1	• Used to protect flush pushbuttons from inadvertent operation. • Can be easily attached using the locking ring. <div style="text-align: right;">  </div>									
Locking Attachment 	Metal (zinc-plated)	OL-H	OL-H	1	• Used to lock an extended pushbutton in the depressed position. • Can be easily attached using the locking ring. <div style="text-align: right;">  </div>									





ø30 ø30 series Accessories and Replacement Parts

Maintenance Parts

Shape	Specification	Part No.	Ordering No.	Package Quantity	Remarks
Metallic Bezel 	Metal (zinc diecast: chrome-plated)	OG-11	OG-11PN02	2	<ul style="list-style-type: none"> Cannot be used with pin lock, selector pushbuttons, and monolever units.
Plastic Bezel 	Plastic (polycarbonate)	OGP-11*	OGP-11*PN02	2	Specify a color code in place of *. B (black), G (green), R (red), W (white), Y (yellow) <ul style="list-style-type: none"> Cannot be used with pin lock, selector pushbuttons, and monolever units.
Clear Plastic Bezel for Flush Pushbuttons 	Clear Plastic (acrylic)	OGP-13	OGP-13PN02	2	<ul style="list-style-type: none"> Clear plastic bezel and full shroud. OGP-1411 cannot be used with LED illumination units and diecast units.
Clear Plastic Bezel for Extended Pushbuttons 		OGP-14	OGP-14PN02	2	
Clear Plastic Bezel for Illuminated Pushbuttons 		OGP-1411	OGP-1411	1	
Metal Bezel for Illuminated Pushbuttons 	Metal (zinc diecast)	OL-11	OL-11PN05	5	
Clear Button Cover 	Clear Plastic (polycarbonate)	ABN1B-C	ABN1B-CPN05	5	<ul style="list-style-type: none"> Used on flush and extended pushbuttons to indicate a mark or a symbol engraved on the marking plate. The clear button cover holds the marking plate. The ø30 series marking chip can only be used on the ABN1 and AON1. Specify a color code in place of *. B (black), G (green), R (red), W (white), Y (yellow)
Marking Plate 	Plastic (polyacetal)	TN-0*	TN-0*PN10	10	

ø30 Series Accessories and Replacement Parts ø30

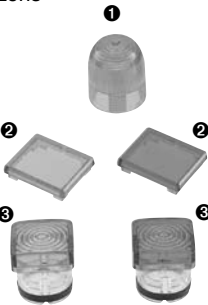
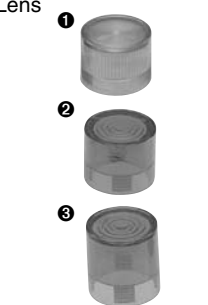

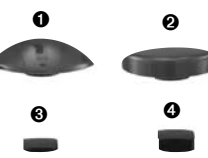





Maintenance Parts

Shape	Description	Material	Part No.	Ordering No.	Package Quantity	Color		
	1NO contact		BS010E	BS010E	1	<ul style="list-style-type: none"> • Push rod color: Green • -MAU has gold contacts 		
			BS010E-MAU	BS010E-MAU				
	1NC contact		BS001E	BS001E	1	<ul style="list-style-type: none"> • Push rod color: Red • -MAU has gold contacts 		
			BS001E-MAU	BS001E-MAU				
	EM contact (early make)		BS010SE	BS010SE	1	<ul style="list-style-type: none"> • Push rod color: Black • -MAU has gold contacts 		
			BS010SE-MAU	BS010SE-MAU				
	LB contact (late break)		BS001SE	BS001SE	1	<ul style="list-style-type: none"> • Push rod color: White • -MAU has gold contacts 		
			BS001SE-MAU	BS001SE-MAU				
	1NO contact	BST010	BST010	1	<ul style="list-style-type: none"> • Push rod color: Green 	<ul style="list-style-type: none"> • -MAU has gold contacts Applicable Units: <ul style="list-style-type: none"> • Pushlock Turn Reset • Push Turn Lock • LED Illuminated Pushbutton • LED Illuminated Selector Switch • Incandescent Illuminated Selector Switch 		
		BST010-MAU	BST010-MAU					
	1NC contact	BST001	BST001	1	<ul style="list-style-type: none"> • Push rod color: Red 			
		BST001-MAU	BST001-MAU					
	EM contact (early make)	BST010S	BST010S	1	<ul style="list-style-type: none"> • Push rod color: Black 			
	LB contact (late break)	BST001S	BST001S	1	<ul style="list-style-type: none"> • Push rod color: White 			
		① Used for APN(E)1	Plastic	APN106LN-②	APN106LN-②PN05		5	<ul style="list-style-type: none"> A (amber), C (clear), G (green), R (red), S (blue), W (white), Y (yellow) • Use the white (W) lens for pure white illumination
		② Used for UPQNE4 U(O)LQN* B		UPQN406L-②	UPQN406L-②PN05		5	<ul style="list-style-type: none"> C (clear), G (green), R (red), S (blue) • Use the clear (C) lens for white illumination.
UPQN406LD-②				UPQN406LD-②PN05	<ul style="list-style-type: none"> A (amber), Y (yellow) • Use the amber (A) lens for orange illumination. 			
③ Used for UPQN3B U(O)LQN		ULQN06L-②		ULQN06L-②PN05	5	<ul style="list-style-type: none"> C (clear), G (green), R (red), S (blue) 		
		UPQN06LD-②		UPQN06LD-②PN05		<ul style="list-style-type: none"> A (amber), W (white), Y (yellow) • Use the amber (A) lens for orange illumination. 		
	① Used for ALN, AOLN (LED)	Plastic	ALN2L-②	ALN2L-②PN05	5	<ul style="list-style-type: none"> G (green), R (red), S (blue) 		
	② Used for ALN, AOLN (incandescent) (1W)		ALN2LD-②	ALN2LD-②PN05	5	<ul style="list-style-type: none"> A (amber), W (white), Y (yellow) • Use the white (W) lens for pure white illumination 		
			ALN06L-②	ALN06L-②PN05	5	<ul style="list-style-type: none"> C (clear), G (green), R (red), S (blue) 		
	③ Used for ALN, AOLN (incandescent) (2W)		ALN06LD-②	ALN06LD-②PN05	5	<ul style="list-style-type: none"> A (amber), W (white) • Use the amber (A) lens for orange illumination. 		
			ALN08L-②	ALN08L-②PN05	5	<ul style="list-style-type: none"> C (clear), G (green), R (red), S (blue) 		
	ALN08LD-②		ALN08LD-②PN05	5	<ul style="list-style-type: none"> A (amber), W (white) • Use the amber (A) lens for orange illumination. 			
	Flush	Plastic	ABN1B-①	ABN1B-①PN05	5	<ul style="list-style-type: none"> G (green), R (red), Y (yellow) Above colors are used for ø30 control units (dark colored operator units). For black, use black buttons from light colored operator units. 		
	Extended		ABN2B-①	ABN2B-①PN05	5			
	Mushroom		ABN3B-①	ABN3B-①PN02	2			
	Flush		ABN1BN-①	ABN1BN-①PN05	5	<ul style="list-style-type: none"> B (black), G (green), R (red), S (blue), Y (yellow), W (white) Above colors are used for ø30 diecast zinc control units (light colored operator units). 		
	Extended		ABN2BN-①	ABN2BN-①PN05	5			
	Mushroom		ABN3BN-①	ABN3BN-①PN02	2			
	① Mushroom (ABN4)		Plastic	ABN4B-①	ABN4B-①	1	<ul style="list-style-type: none"> B (black), G (green), R (red), Y (yellow) 	
	② Mushroom (ABN4G/ABN4F)			ABN4GB-①	ABN4GB-①	1		
	③ Square Flush (UBQN1)			UBQN1B-①	UBQN1B-①PN02	2		
	④ Square Extended (UBQN2)	UBQN2B-①		UBQN2B-①PN02	2			

Note: Specify a button color code or lens color code in place of ① or ② in the Ordering No.



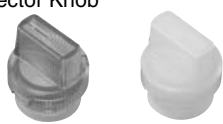

ø30 ø30 series Accessories and Replacement Parts

Maintenance Parts



Shape	Description	Material	Part No.	Ordering No.	Package Quantity	Remarks
	For ø40 pushlock turn reset pushbuttons (for AVN3)	AS resin	AVN3B-②	AVN3B-②	1	R (red), Y (yellow)
	For ø40 pushlock turn reset pushbuttons (for AVLN3, AVLNE3)	AS resin	AVLN3L-R	AVLN3L-RPN02	2	Red only
	For ø40 pushlock turn reset pushbuttons (for AJN3)	AS resin	AJN3B-②	AJN3B-②	1	B (black), G (green), R (red), Y (yellow)
	For ø40 pushlock turn reset pushbuttons (for AJLN3)	AS resin	AJLN3L-②	AJLN3L-②		-G (green), -R (red), L-Y (yellow), L-A (amber), L-W (white)
	For UPQN4	Plastic	UPQN406N-W	UPQN406N-WPN05	5	
		Rubber	OW-12	OW-12PN10	10	
		Rubber	OW-11	OW-11PN10	10	
	① Half shroud (for pushbuttons)	Metal	ABN2G	ABN2G	1	
	② Full shroud (for pushbuttons)		ABN2F	ABN2F	1	
	③ Full shroud (for mushroom pushbuttons)		ABN3G	ABN3G	1	
	④ Shallow shroud (for jumbo mushrooms)		ABN4G	ABN4G	1	
	⑤ Deep shroud (for jumbo mushrooms)		ABN4F	ABN4F	1	
	⑥ Half shroud (for illuminated pushbuttons)		ALN1GL	ALN1GL	1	• For incandescent/LED illuminated pushbuttons (E12 base)
			ALN2GL	ALN2GL	1	• For LED illuminated pushbuttons (BA9S base)
	⑦ Full shroud (for illuminated pushbuttons)		ALN1F	ALN1F	1	• For incandescent/LED illuminated pushbuttons (E12 base)
	ALN2FL	ALN2FL	1	• For LED illuminated pushbuttons (BA9S base)		
	Knob for illuminated selector switch	AS resin	ASLNH	ASLNH-*		G (green), R (red), S (blue)
			ASLNHD	ASLNHD-*		A (amber), W (white), Y (yellow)

ø30 Series Accessories and Replacement Parts ø30

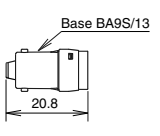

Maintenance Parts

Shape	Description	Material	Part No.	Ordering No.	Package Quantity	Remarks
Spare Key 	① ASN3K/4K, ABN5	Metal	ASN-T1SK-24401	ASN-T1SK-24401PN02	2	• Applicable to ABN3K, ABN4K, ABN5
	② ASN*K		ASN-SK-24401	ASN-SK-24401PN02		
Spare Key 	ASN□K□-T ASN*K		TW-SK-0	TW-SK-0PN02	2	
Transformer 	100/110V AC (for LED/1W incandescent lamps)	TWR-016N	TWR-016N	1	Mounting screws are not included.	
	200/220V AC (for LED/1W incandescent lamps)	TWR-026N	TWR-026N	1		
Pin/Chain 	For ABN8P pinlock	Metal	ABN8P-PIN	ABN8P-PIN	1	Pin, chain, and plate for ABN8P

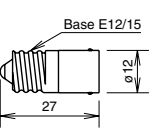
LED Lamps

Dimensions	Operating Voltage	Current Draw		Part No.	Ordering No.	② Illumination Color Code	Package Quantity	Base
		AC	DC					
 	6V AC/DC ±10%	8 mA	7 mA (A, R, W) 5.5 mA (G, PW, S)	LSTD-6②	LSTD-6②	A: amber G: green PW: pure white R: red S: blue W: white	1	BA9S/13
					LSTD-6②PN10	10		
	12V AC/DC ±10%	11 mA	10 mA	LSTD-1②	LSTD-1②	Use a pure white (PW) LED lamp with yellow (Y) lens.	1	
					LSTD-1②PN10		10	
24V AC/DC ±10%	11 mA	10 mA	LSTD-2②	LSTD-2②	1			
				LSTD-2②PN10	10			
 	6V AC/DC ±10%	17 mA (A, R, W, Y) 8 mA (G, PW, S)	14 mA (A, R, W, Y) 5.5 mA (G, PW, S)	LETD-6②	LETD-6②	A: amber G: green R: red S: blue W: white Y: yellow	1	E12/15
					LETD-6②PN10		10	
	12V AC/DC ±10%	7 mA	6.5 mA	LETD-8②	LETD-8②		1	
					LETD-8②PN10		10	
	24V AC/DC ±10%	11 mA	10 mA	LETD-2②	LETD-2②		1	
					LETD-2②PN10		10	

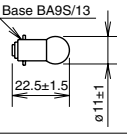

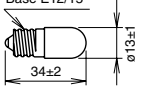
Incandescent Lamps

Dimensions	Rated Operating Voltage	Lamp Ratings	Part No.	Package Quantity	Life
 	6V AC/DC	1W (6.3V)	LS-6	1	Approx. 1000 hours minimum (reference value)
	12V AC/DC	1W (18V)	LS-8		
	18V AC/DC	1W (24V)	LS-2		
	24V AC/DC	1W (30V)	LS-3		
 	6V AC/DC	2W (6.3V)	LE-6	1	
	12V AC/DC	2W (18V)	LE-8		
	18V AC/DC	2W (24V)	LE-2		
	24V AC/DC	2W (30V)	LE-3		

• Specify a color code in place of ② in the Ordering No.

ø30 ø30 series Accessories and Replacement Parts

Transformer

DIN Rail Mount	Primary Voltage	Secondary Voltage	Part No.	Applicable Load
 For 1W	100/110V AC	5.5V	TWR516	One full voltage pilot light or illuminated switch containing LSTD-6②, LETD-6② LED lamp (6V AC/DC) or LS-6 incandescent lamp (6.3 V AC/DC, 1W)
	200/220V AC		TWR526	
	400/440V AC		TWR546	
 For 2W	100/110V AC	15V	TWR518	One full voltage pilot light or illuminated switch containing LE-8 incandescent lamp (18V AC/DC, 2W)
	200/220V AC		TWR528	
	400/440V AC		TWR548	

Specifications

Operating Voltage	100/110V AC, 115/120V AC, 200/220V AC, 230/240V AC, 380V AC, 400/440V AC, 480V AC (50/60Hz)
Current Draw	2.4 VA
Rated Insulation Voltage	600V
Insulation Resistance	100 MΩ minimum (500V DC megger)
Operating Temperature	-30 to +60°C (no freezing)
Storage Temperature	-40 to +80°C (no freezing)
Operating Humidity	35 to 85% RH (no condensation)
Vibration Resistance	Damage Limits: 30 Hz, amplitude 1.5 mm Operating extremes: 5 to 55 Hz, amplitude 0.5 mm
Shock Resistance	Damage limits, Operating Extremes: 1,000 m/s ²
Dielectric Strength	2,500V AC, 1 minute
Terminal Screw	M3.5
Applicable Wire	2 mm ² maximum, 2 wires maximum
Weight (approx.)	87g

Dimensions

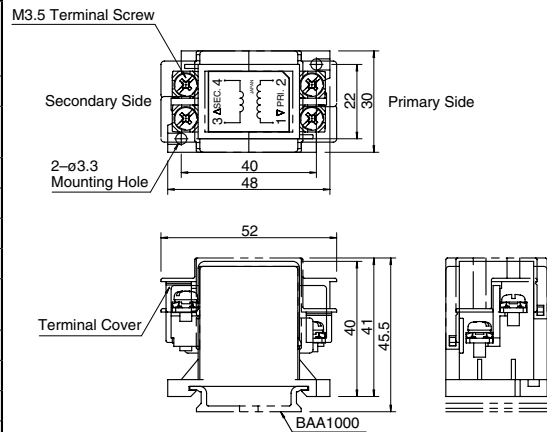

Accessories

DIN Rail

Part No.	Ordering No.	Length	Weight (approx.)	Material	Package Quantity
BAA1000	BAA1000PN10	1000 mm	200g	Aluminum	10
BAP1000	BAP1000PN10	1000 mm	320g	Steel	10

End Clip

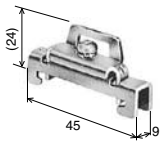
Part No.	Ordering No.	Applicable DIN Rail	Weight (approx.)	Material	Package Quantity	Dimensions
BNL6	BNL6PN10	BAA1000 BAP1000	15g	Steel (Zinc-plated)	10	

Use plastic end clip BC9Z-E/NS35N when using 400/440V AC primary voltage transformers.

Safety Precautions

- Turn off the power to the ø30 series control units before starting installation, removal, wiring, maintenance, and inspection of the products. Failure to turn power off may cause electrical shocks or fire hazard.
- To avoid a burn on your hand, use the lamp holder tool when replacing lamps.
- For wiring, use wires of a proper size to meet the voltage and current requirements. Tighten the M3.5 terminal screws to a tightening torque of 1.0 to 1.3 N·m. Failure to tighten terminal screws may cause overheat and fire.

Instructions

Panel Mounting for Square Pushbuttons and Pilot Lights

1. Tighten the square ring to the operator and position the ring correctly.
2. Lightly tighten the screw to secure the pilot light onto the panel.

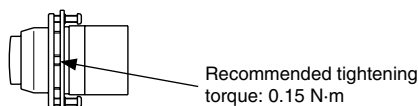

Recommended tightening torque: 0.15 N·m

Tightening Torque for Terminal Screws

Tighten the terminal screws to a torque of 1.0 to 1.3 N·m.

Replacement of Lamps

Lamps can be replaced by using the lamp holder tool (OR-55) from the front of the panel.

How to Remove

To remove, slip the lamp holder tool onto the lamp head lightly. Then push slightly, and turn the lamp holder tool counterclockwise.

How to Install

To install, insert the lamp head into the lamp holder tool. Place the pins on the lamp base to the grooves in the lamp socket. Inset the lamp and turn it clockwise.



OR-55



Installing the Anti-rotation Ring

Anti-rotation rings are used on selector switches or pushbuttons which rotate and used when using no nameplates.

Insert a 1.5mm thick rubber washer between the panel and the anti-rotation ring as shown on the right.

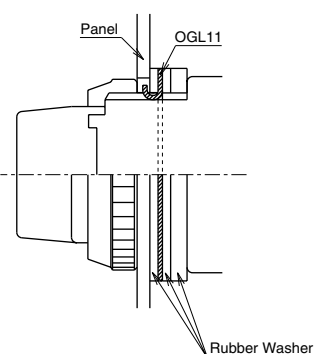

Panel Thickness and Rubber Washer

Adjust the thickness of the rubber washers according to the panel thickness. Also, make sure to include the nameplate thickness when using a nameplate.

Applicable Models

- Extended Illuminated Pushbuttons with Half Shroud (LED)
- Extended Pushbuttons with Half Shroud (Diecast)
- Extended Illuminated Pushbuttons with Half Shroud (Diecast)

Panel Thickness (mm)	Rubber Washer	
	1.5mm	3.0mm
Supplied	1 piece	1 piece
0.8 to 1.8	–	1 piece
1.8 to 3.5	1 piece	–

Applicable Models

- Extended Pushbuttons with Half Shroud
- Extended Illuminated Pushbuttons with Half Shroud (Incandescent)

Panel Thickness (mm)	Rubber Washer	
	1.5mm	3.0mm
Supplied	1 piece	1 piece
0.8	1 piece	1 piece
0.8 to 2.3	–	1 piece
2.3 to 4.0	1 piece	–

Applicable Models

- Extended Illuminated Pushbuttons with Full Shroud (Incandescent)
- Extended Illuminated Pushbuttons with Full Shroud (LED)
- Extended Illuminated Pushbuttons with Full Shroud (Diecast)
- Mushroom Pushbuttons with Full Shroud

Panel Thickness (mm)	Rubber Washer	
	1.5mm	3.0mm
Supplied	2 pieces	1 piece
0.8 to 2.0	1 piece	1 piece
2.0 to 3.5	1 piece	1 piece
3.5 to 5.0	–	1 piece
5.0 to 6.0 (6.5)	1 piece	–

The number in brackets is for mushroom pushbuttons with full shroud. Extended illuminated pushbuttons with full shroud (incandescent) are 5.0 mm maximum.

Applicable Models

- Toggle Lever
- Knob Push Turn Lock Illuminated Pushbuttons

Panel Thickness (mm)	Rubber Washer	
	1.5mm	3.0mm
Supplied	1 piece	1 piece
0.8 to 2.0	1 piece	1 piece
2.0 to 3.5	–	1 piece
3.5 to 5.5 (5.0)	1 piece	–

The number in brackets is for knob push turn lock illuminated pushbuttons.

Applicable Models

- Extended Pushbuttons with Full Shroud

Panel Thickness (mm)	Rubber Washer	
	1.5mm	3.0mm
Supplied	3 pieces	1 piece
0.8 to 1.5	3 pieces	1 piece
1.5 to 3.0	2 pieces	1 piece
3.0 to 4.5	1 piece	1 piece
4.5 to 6.0	–	1 piece
6.0 to 7.5	1 piece	–

Applicable Models

- Extended Pushbuttons with Full Shroud (Diecast)

Panel Thickness (mm)	Rubber Washer	
	1.5mm	3.0mm
Supplied	2 pieces	1 piece
0.8 to 2.5	2 pieces	1 piece
2.5 to 4.0	1 pieces	1 piece
4.0 to 5.5	–	1 piece
5.5 to 6.0	1 piece	–

Applicable Models

- Other Models (Excluding Square)

Panel Thickness (mm)	Rubber Washer	
	1.5mm	3.0mm
Supplied	2 pieces	1 piece
0.8 to 3.5	2 pieces	1 piece
3.5 to 5.0	1 piece	1 piece
5.0 to 6.5	–	1 piece
6.5 to 7.5	1 piece	–

Installation of LED Illuminated Units

1. Note the polarity for wiring when connecting to DC-DC converter unit.

Terminal No.	Polarity
X1	Positive
X2	Negative

2. Transformer units are recommended for use in areas subjected to noise.

3. Notes for Pure White LED Lamps

- Do not use the pure white LED outdoors, otherwise it will lead to the degradation of brightness and color. Do not remove or apply shock to the cap on the pure white LED lamp, otherwise it may break or damage the cap.
- For the pure white LED, use a white lens. The illumination color will be dull if a different color is used.

Notes on LED Illuminated Units

LED lamps consist of semiconductors. If the applied voltage exceeds the rated voltage, LED elements may deteriorate due to overheat, resulting in significant decrease in luminance, hue change, or failure of lighting. Also, if an extraneous noise, transient voltage, or transient current is applied to the circuit, similar effects may occur. When using LED lamps, observe the following instructions.

Rated Voltage

The LED lamps are rated at 6V, 12V, or 24V AC/DC, and can be used within $\pm 10\%$ the rated voltage of either AC or DC.

DC Power

1. Switching power supply

Regulated voltage from switching power supply is best suited. Make sure to use within the rated voltage of the LED lamp.

2. Rechargeable battery

Note that the battery voltage may exceed the rated voltage of the LED lamp while the battery is being charged and immediately after the charging is complete. Be sure to use the LED lamp on a voltage of $\pm 10\%$ the rated voltage.

3. Full-wave rectification

Since the LED lamp is AC/DC compatible, a diode bridge for rectification is not necessary. If the LED lamp is used on a full-wave rectification current through a diode bridge, the rectifier diodes will reduce the voltage, resulting in lower luminance.

4. Single-phase half-wave rectification

This is not suitable for the power source of LED lamps. Use constant-voltage DC power.

Noise

LED elements deteriorate due to extraneous noise, resulting in significant decrease in luminance, hue change, or failure of lighting. When such effects are anticipated, take a protection measure shown below, such as RC elements or a surge absorber.

[Protection Example 1] For AC circuit

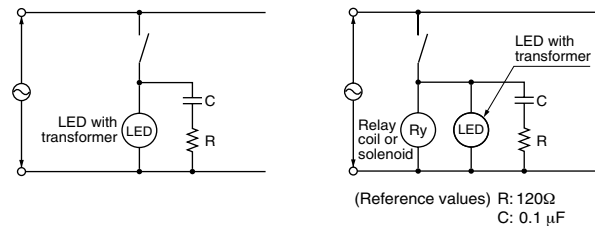

[Protection Example 2] For DC circuit

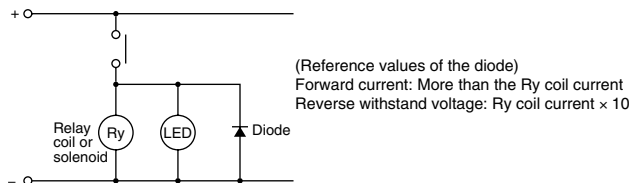

Countermeasures against Dim Lighting

1. Leakage currents through the transistors or a contact protection circuit may cause the LED lamp to illuminate dimly even when the output is off.
2. When the LED lamp is illuminated by a transistor output, take the following measure.

[Circuit Example]

Connect shunt resistor R in parallel with the LED lamp.

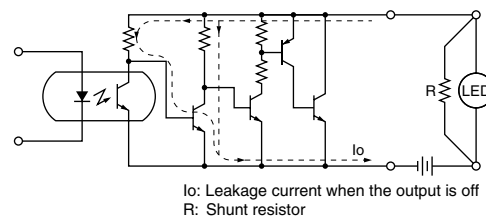

ø30 series Diecast Zinc Control Units

Heavy duty switches for tough industrial usage

- Degree of protection: IP65 (IEC 60529)
- UL, CSA approved, and EN compliant

Applicable Standards	Mark	File No. or Organization
UL 508		UL Listing File No. E68961
CSA C22.2 No.14		CSA File No. LR21451
EN60947-5-1		EU Low Voltage Directive
GB14048.5		CCC No. 200501030514650



Specifications and Ratings

Contact Ratings

Pushbuttons Illuminated Pushbuttons Selector Switches Illuminated Selector Switches Selector Pushbuttons	Contact Block	BST (ø30 series)
	Rated Insulation Voltage	600V
	Rated Continuous Current	10A
	Contact Ratings by Utilization Category IEC 60947-5-1	AC-15 (A600) DC-13 (P600)

Weight (Examples)

Weight (approx.)	135g (ABD 122N)
	71g (APD122DN)
	116g (ALD22211DN)
	125g (ASD222N)
	168g (ASD2K22N)
	147g (ASLD2222DN)
116g (ASBD211N-A03)	

Characteristics

Contact Ratings by Utilization Category

Operational Voltage			24V	48V	50V	110V	220V	440V
Operational Current	AC 50/60 Hz	AC-12 Control of resistive loads and solid state loads	10A	—	10A	10A	6A	2A
		AC-15 Control of electromagnetic loads (> 72 VA)	10A	—	7A	5A	3A	1A
	DC	DC-12 Control of resistive loads and solid state loads	10A	5A	—	2.2A	1.1A	—
		DC-13 Control of electromagnets	5A	2A	—	1.1A	0.6A	—

Note: The operational current represents the classification by making and breaking currents (IEC 60947-5-1).
Minimum applicable load: 3V AC/DC, 5 mA (applicable range may vary with operating conditions and load types)

BST Contact Block (Light Gray)

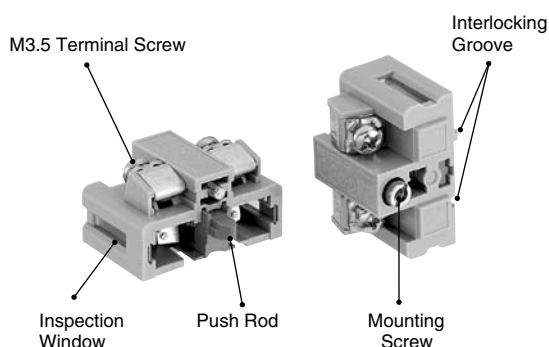

Contact Blocks

Contact		Single-pole Contact Block			
Part No.	BST	BST010	BST001	BST010S	BST001S
Push Rod		Green	Red	Black	White

Note: BST contact blocks are not interchangeable with dark gray BS contact blocks used for ø30 control units.

Specifications, ratings, and mounting hole layouts are the same as ø30 control units.
See "ø30 Series Control Units" on page 16.

ø30 ø30 Series Diecast Zinc Control Units

Ordering Information

Standard Units

- Specify an operator or lens color code in the Part No.
- Black, green, and red colored buttons are included with flush pushbuttons.
- Terminal covers, nameplates, and accessories are ordered separately.

Terminal Cover

- When a terminal cover is required, order an applicable terminal cover referring to page 67.

The Part No. development charts shown below can be used to specify control units other than those listed on the following pages.

ø30 Series Diecast Zinc Pushbuttons

ABD2 11 N R

Button color code

Contact arrangement code

10: 1NO	01: 1NC
11: 1NO-1NC	20: 2NO
02: 2NO	22: 2NO-2NC
40: 4NO	04: 4NO
13: 1NO-3NC	31: 3NO-1NC
30: 3NO	03: 3NC
12: 1NO-2NC	21: 2NO-1NC

Note:

- Mushroom pull AZD3 can have a maximum of two contact blocks.
- Mushroom push pull AYD31 can have a maximum of two contact blocks.

ø30 Series Diecast Zinc Pilot Lights

APDE 1 99 D N R

Lens color code

Operating voltage code

Lamp receptacle:

E: E12 (LETD-6[Ⓢ] LED or 2W incandescent lamps)

(blank): BA9S (LSTD-6[Ⓢ] LED or 1W incandescent lamps)

ø30 Series Diecast Zinc Illuminated Pushbuttons

ALDE 2 16 11 D N R

Lens color code

Contact arrangement code

11: 1NO-1NC	20: 2NO
02: 2NC	31: 3NO-1NC
22: 2NO-2NC	13: 1NO-3NC
40: 4NO	04: 4NC

Operating voltage code

Lamp receptacle

E: E12 (LETD-6[Ⓢ] LED or 2W incandescent lamps)

(blank): BA9S (LSTD-6[Ⓢ] LED or 1W incandescent lamps)

Note:

- Illuminated pushbuttons cannot have an odd number of contact blocks, such as 1NO, 1NC, 3NO, 2NO-1NC, 1NO-2NC, and 3NC.

ø30 Series Diecast Zinc Control Units ø30

ø30 Series Diecast Zinc Selector Switch

ASD 2 L 11 N

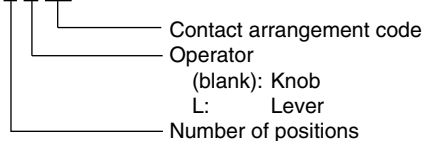

ø30 Series Diecast Zinc Illuminated Selector Switch

ASLD 2 16 22 D N R

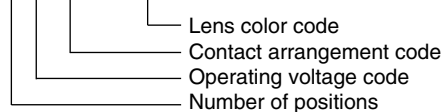

ø30 Series Diecast Zinc Key Selector Switch

ASD 2 K 20 N B

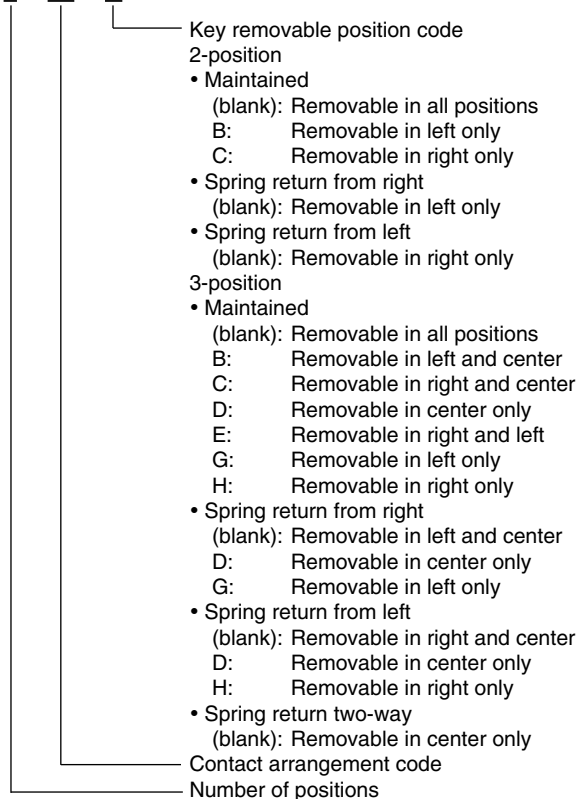













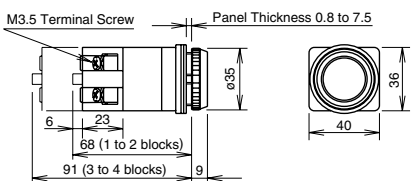





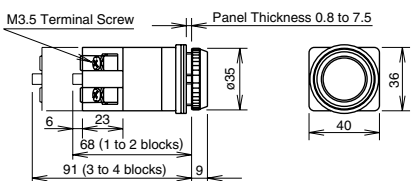





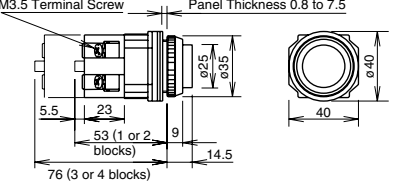





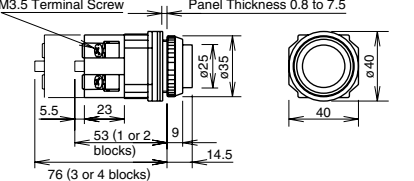





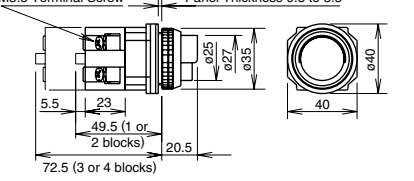





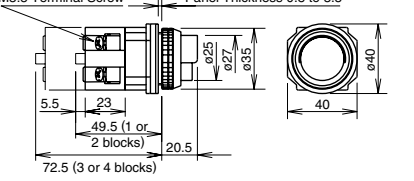

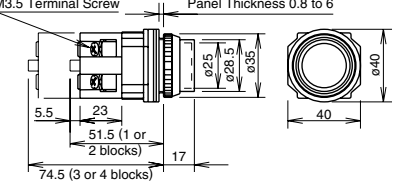

Note:

- The key cannot be removed in the return position.

ø30 ø30 Diecast Zinc Series Pushbuttons



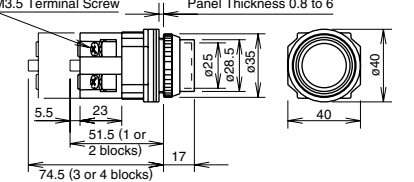









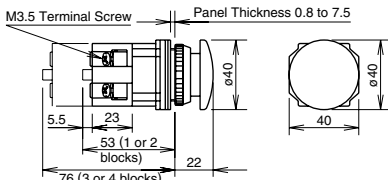

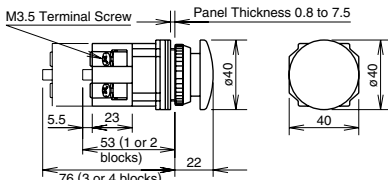
Flush / Extended / Extended with Half Shroud / Extended with Full Shroud

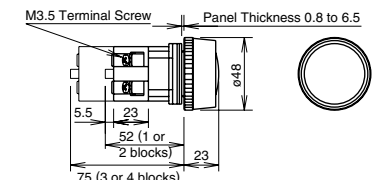
Shape	Operation	Contact	Part No.	① Button Color Code	Dimensions (mm)
Flush ABD1     	Momentary	1NO	ABD110N ①	Black (B), green (G), and red (R) buttons are supplied with each unit.	
		1NC	ABD101N ①		
		1NO-1NC	ABD111N ①		
		2NO	ABD120N ①		
		2NC	ABD102N ①		
Flush AOD1     	Maintained	1NO	AOD110N ①	Specify S, Y, or W when a blue, yellow, or white button is required.	
		1NC	AOD101N ①		
		1NO-1NC	AOD111N ①		
		2NO	AOD120N ①		
		2NC	AOD102N ①		
Extended ABD2     	Momentary	1NO	ABD210N ①		
		1NC	ABD201N ①		
		1NO-1NC	ABD211N ①		
		2NO	ABD220N ①		
		2NC	ABD202N ①		
Extended AOD2     	Maintained	1NO	AOD210N ①		
		1NC	AOD201N ①		
		1NO-1NC	AOD211N ①		
		2NO	AOD220N ①		
		2NC	AOD202N ①		
Extended with Half Shroud ABGD2     	Momentary	1NO	ABGD210N ①	Specify a button color code in place of ① in the Part No.	
		1NC	ABGD201N ①		
		1NO-1NC	ABGD211N ①		
		2NO	ABGD220N ①		
		2NC	ABGD202N ①		
Extended with Half Shroud AOGD2     	Maintained	1NO	AOGD210N ①	B: black G: green R: red S: blue W: white Y: yellow	
		1NC	AOGD201N ①		
		1NO-1NC	AOGD211N ①		
		2NO	AOGD220N ①		
		2NC	AOGD202N ①		
Extended with Full Shroud ABFD2     	Momentary	1NO	ABFD210N ①		
		1NC	ABFD201N ①		
		1NO-1NC	ABFD211N ①		
		2NO	ABFD220N ①		
		2NC	ABFD202N ①		
Extended with Full Shroud AOFD2     	Maintained	1NO	AOFD210N ①		
		1NC	AOFD201N ①		
		1NO-1NC	AOFD211N ①		
		2NO	AOFD220N ①		
		2NC	AOFD202N ①		

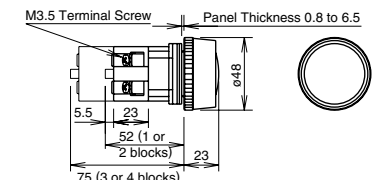
- Round bezel and shroud (metal): Chrome-plated
- Pushbuttons with one or three contact blocks contain a dummy block
- Other contact arrangements are also available. See page 80.

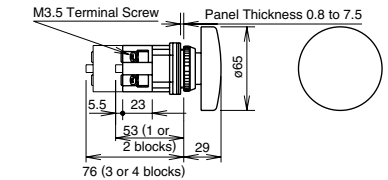
ø30 Diecast Zinc series Pushbuttons ø30

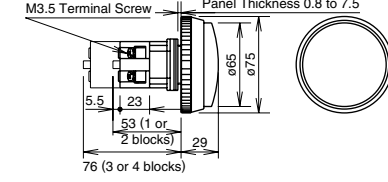

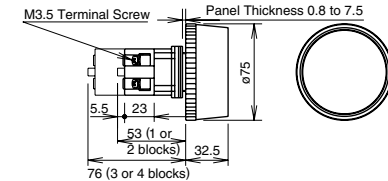





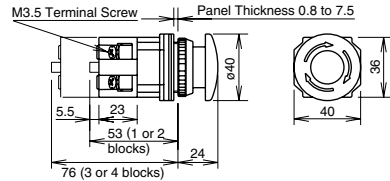

Mushroom / Jumbo Mushroom Pushbuttons

Shape	Operation	Contact	Part No.	① Button Color Code	Dimensions (mm)
Mushroom ABD3  	Momentary	1NO	ABD310N ①	B: black G: green R: red W: white Y: yellow	
		1NC	ABD301N ①		
		1NO-1NC	ABD311N ①		
		2NO	ABD320N ①		
		2NC	ABD302N ①		
		2NO-2NC	ABD322N ①		
Mushroom AOD3  	Maintained	1NO	AOD310N ①	B: black G: green R: red W: white Y: yellow	
		1NC	AOD301N ①		
		1NO-1NC	AOD311N ①		
		2NO	AOD320N ①		
		2NC	AOD302N ①		
		2NO-2NC	AOD322N ①		
Mushroom with Full Shroud ABGD3  	Momentary	1NO	ABGD310N ①	B: black G: green R: red W: white Y: yellow	
		1NC	ABGD301N ①		
		1NO-1NC	ABGD311N ①		
		2NO	ABGD320N ①		
		2NC	ABGD302N ①		
		2NO-2NC	ABGD322N ①		
Mushroom with Full Shroud AOGD3  	Maintained	1NO	AOGD310N ①	B: black G: green R: red W: white Y: yellow	
		1NC	AOGD301N ①		
		1NO-1NC	AOGD311N ①		
		2NO	AOGD320N ①		
		2NC	AOGD302N ①		
		2NO-2NC	AOGD322N ①		
Jumbo Mushroom ABD4  	Momentary	1NO	ABD410N ①	B: black G: green R: red W: white Y: yellow	
		1NC	ABD401N ①		
		1NO-1NC	ABD411N ①		
		2NO	ABD420N ①		
		2NC	ABD402N ①		
		2NO-2NC	ABD422N ①		
Jumbo Mushroom with Shallow Shroud ABGD4  	Momentary	1NO	ABGD410N ①	B: black DG: dark green DR: dark red G: green R: red Y: yellow	
		1NC	ABGD401N ①		
		1NO-1NC	ABGD411N ①		
		2NO	ABGD420N ①		
		2NC	ABGD402N ①		
		2NO-2NC	ABGD422N ①		
Jumbo Mushroom with Deep Shroud ABFD4  	Momentary	1NO	ABFD410N ①	B: black DG: dark green DR: dark red G: green R: red Y: yellow	
		1NC	ABFD401N ①		
		1NO-1NC	ABFD411N ①		
		2NO	ABFD420N ①		
		2NC	ABFD402N ①		
		2NO-2NC	ABFD422N ①		

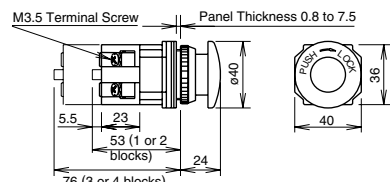
- Specify a button color code in place of ① in the Part No.
- Round bezel and shroud (metal): Chrome-plated
- Pushbuttons with one or three contact blocks contain a dummy block
- Other contact arrangements are also available. See page 80.

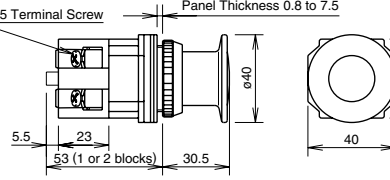
ø30 ø30 Diecast Zinc Series Pushbuttons

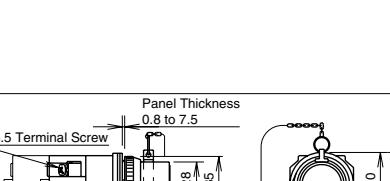

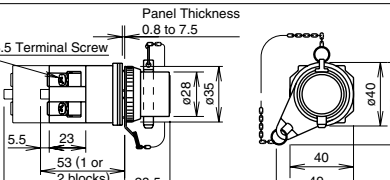







Pushlock Turn Reset / Push Turn Lock / Pull / Push-Pull / Pin Lock Pushbuttons

Shape	Contact	Part No.	① Button Color Code	Dimensions (mm)
Mushroom Pushlock Turn Reset AVD3  	1NO	AVD310N①	R: red Y: yellow	
	1NC	AVD301N①		
	1NO-1NC	AVD311N①		
	2NO	AVD320N①		
	2NC	AVD302N①		
Mushroom Push Turn Lock AJD3  	1NO	AJD310N①	B: black G: green R: red Y: yellow	
	1NC	AJD301N①		
	1NO-1NC	AJD311N①		
	2NO	AJD320N①		
	2NC	AJD302N①		
Mushroom Pull AZD3  	1NO	AZD310N①	B: black G: green R: red S: blue Y: yellow	
	1NO-1NC	AZD311N①		
	2NO	AZD320N①		
	2NC	AZD302N①		
Mushroom Push-Pull AYD31  	1NO-1NC	AYD3111N①	B: black G: green R: red S: blue Y: yellow	
	2NO	AYD3120N①		
	2NC	AYD3102N①		
Pin Lock ABD8P  	1NO	ABD8P10N①		
	1NC	ABD8P01N①		
	1NO-1NC	ABD8P11N①		
	2NO	ABD8P20N①		
	2NC	ABD8P02N①		
	2NO-2NC	ABD8P22N①		







- Specify a button color code in place of ① in the Part No.
- Round bezel (metal): Chrome-plated
- Pushbuttons with one or three contact blocks contain a dummy block.
- Other contact arrangements are also available. See page 80.
- Pushlock Turn Reset:** Button is maintained when pressed and is reset when turned clockwise. Red buttons only.
- Note: AVD3 pushlock turn reset switches cannot be used as emergency stop switches. When emergency stop switches are required, use XN or HN series emergency stop switches (ISO 13850 and IEC 60947-5-5 compliant).
- Push Turn Lock:** Button is locked when turned clockwise in the depressed position and is reset when turned counterclockwise.
- Pull:** Pulling the button operates the contacts. Up to 2 contact blocks (1 layer) can be mounted on pull switches.
- Push-Pull:** Button is maintained in both depressed and reset positions. Up to 2 contact blocks (1 layer) can be mounted on AYD31 push-pull switches.
- Note: AYD31 push-pull switches cannot be used as emergency stop switches. When emergency stop switches are required, use the HN1E series emergency stop switches (ISO 13850 and IEC 60947-5-5 compliant).
- Pin Lock:** Button can be locked in either depressed or reset position by inserting the pin. Pad lock with a ø5mm pin can also be used to lock the button.

Contact Operation

Pull Switch (Spring Return)

Contact	AZD3	
	Normal	Pull
1NO		
1NC		
1NO-1NC		
2NO		
2NC		





Push-Pull Switch (Maintained)

Contact	AYD31	
	Push	Pull
1NO-1NC		
2NO		
2NC		

Note: Pull and push-pull switches can have a maximum of two contact blocks.

ø30 Diecast Zinc Series Pilot Lights ø30

APD1 / APDE1 Dome Pilot Lights

Shape	Lamp	Lamp Receptacle	Part No.	② Lens/LED Color Code	Applicable Lamp	
Dome APD1 APDE1    	Without Lamp	BA9S	APD199N ②	A: amber G: green S: blue DNY: yellow	See page 75 for lamps.	
		E12	APDE199N ②	C: clear R: red W: white		
	LED	BA9S	APD1 ③ DN ②	A: amber PW: pure white S: blue Y: yellow	G: green R: red W: white	LSTD-*②
		E12	APDE1 ③ DN ②	A: amber R: red W: white	G: green S: blue Y: yellow	LETD-*②
	Incandescent	BA9S	APD1 ③ N ②	A: amber G: green S: blue	C: clear R: red W: white	LS-*
		E12	APDE1 ③ N ②	A: amber G: green S: blue	C: clear R: red W: white	LE-*

Operating Voltage Code

Specify an operating voltage code in place of ③ in the Part No.

③ Operating Voltage Code			Input
LED	Incandescent (BA9S)	Incandescent (E12)	
66: 6V AC/DC 11: 12V AC/DC 22: 24V AC/DC	66: 6V AC/DC 88: 12V AC/DC 33: 24V AC/DC		Full Voltage
16: 100/110V AC 116: 115V AC 126: 120V AC 26: 200/220V AC 236: 230V AC 246: 240V AC 386: 380V AC 46: 400/440V AC	16: 100/110V AC 116: 115V AC 126: 120V AC 26: 200/220V AC 236: 230V AC 246: 240V AC 386: 380V AC 46: 400/440V AC 486: 480V AC	18: 100/110V AC 118: 115V AC 128: 120V AC 238: 200/220V AC 238: 230V AC 248: 240V AC 388: 380V AC 48: 400/440V AC 488: 480V AC	Transformer

- Specify a lens/LED color code in place of ② in the Part No.
- Use a white lens for LED pure white illumination (LSTD).
- Use a pure white LED lamp for yellow illumination.

Dimensions

Full Voltage

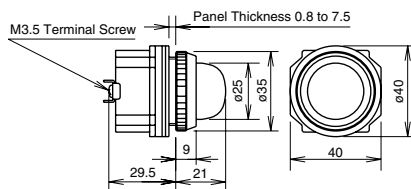



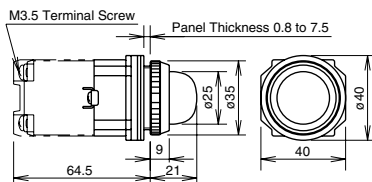

Transformer



All dimensions in mm.

ø30 ø30 Diecast Zinc Series Illuminated Pushbuttons

ALD2 / AOLD2 Round Extended Illuminated Pushbuttons

Shape	Lamp Receptacle	Operation	Lamp	Contact	Part No.	Applicable Lamp	
Round Extended ALD2 AOLD2    	BA9S	Momentary	Without Lamp	1NO-1NC	ALD29911N②	See page 75 for lamps.	
				2NO	ALD29920N②		
				2NC	ALD29902N②		
			LED	1NO-1NC	ALD2③11DN②	LSTD-*②	
				2NO	ALD2③20DN②		
				2NC	ALD2③02DN②		
		Incandescent	1NO-1NC	ALD2③11N②	LS-*		
			2NO	ALD2③20N②			
			2NC	ALD2③02N②			
		Maintained	Without Lamp	Without Lamp	1NO-1NC	AOLD29911N②	See page 75 for lamps.
					2NO	AOLD29920N②	
					2NC	AOLD29902N②	
LED	1NO-1NC		AOLD2③11DN②	LSTD-*②			
	2NO		AOLD2③20DN②				
	2NC		AOLD2③02DN②				
Incandescent	1NO-1NC	AOLD2③11N②	LS-*				
	2NO	AOLD2③20N②					
	2NC	AOLD2③02N②					

Color Code and Operating Voltage Code

Specify a code in place of ② and ③ in the Part No.

② Lens/LED Color Code			③ Operating Voltage Code		Input
Without Lamp	LED	Incandescent	LED	Incandescent (BA9S)	
A: amber C: clear G: green R: red S: blue W: white DNY: yellow	A: amber G: green PW: pure white R: red S: blue W: white Y: yellow	A: amber C: clear G: green R: red S: blue W: white	66: 6V AC/DC 11: 12V AC/DC 22: 24V AC/DC 16: 100/110V AC 116: 115V AC 126: 120V AC 26: 200/220V AC 236: 230V AC 246: 240V AC 386: 380V AC 46: 400/440V AC	66: 6V AC/DC 88: 12V AC/DC 33: 24V AC/DC 16: 100/110V AC 116: 115V AC 126: 120V AC 26: 200/220V AC 236: 230V AC 246: 240V AC 386: 380V AC 46: 400/440V AC 486: 480V AC	Full Voltage Transformer

• Use a pure white LED lamp for yellow illumination.

Dimensions

ALD2/AOLD2
Full Voltage

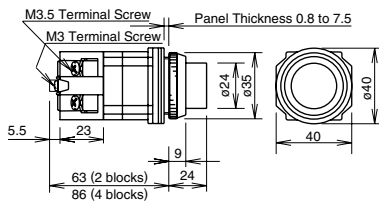



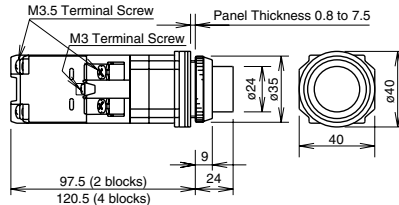

ALD2/AOLD2
BA9S/Transformer



All dimensions in mm.

ø30 Diecast Zinc series Illuminated Pushbuttons ø30

ALFD2 / AOLFD2 Round Extended with Full Shroud Illuminated Pushbuttons

Shape	Lamp Receptacle	Operation	Lamp	Contact	Part No.	Applicable Lamp	
Round Extended with Full Shroud ALFD2 AOLFD2    	BA9S	Momentary	Without Lamp	1NO-1NC	ALFD29911N②	See page 75 for lamps.	
				2NO	ALFD29920N②		
				2NC	ALFD29902N②		
			LED	1NO-1NC	ALFD2③11DN②	LSTD-*(②)	
				2NO	ALFD2③20DN②		
				2NC	ALFD2③02DN②		
		Incandescent	1NO-1NC	ALFD2③11N②	LS-*		
			2NO	ALFD2③20N②			
			2NC	ALFD2③02N②			
		Maintained	Without Lamp	Without Lamp	1NO-1NC	AOLFD29911N②	See page 75 for lamps.
					2NO	AOLFD29920N②	
					2NC	AOLFD29902N②	
LED	LED		1NO-1NC	AOLFD2③11DN②	LSTD-*(②)		
			2NO	AOLFD2③20DN②			
			2NC	AOLFD2③02DN②			
Incandescent	Incandescent	Incandescent	1NO-1NC	AOLFD2③11N②	LS-*		
			2NO	AOLFD2③20N②			
			2NC	AOLFD2③02N②			

Color Code and Operating Voltage Code

Specify a code in place of ② and ③ in the Part No.

② Lens/LED Color Code			③ Operating Voltage Code		Input
Without Lamp	LED	Incandescent	LED	Incandescent (BA9S)	
A: amber C: clear G: green R: red S: blue W: white DNY: yellow	A: amber G: green PW: pure white R: red S: blue W: white Y: yellow	A: amber C: clear G: green R: red S: blue W: white	66: 6V AC/DC 11: 12V AC/DC 22: 24V AC/DC 16: 100/110V AC 116: 115V AC 126: 120V AC 26: 200/220V AC 236: 230V AC 246: 240V AC 386: 380V AC 46: 400/440V AC	66: 6V AC/DC 88: 12V AC/DC 33: 24V AC/DC 16: 100/110V AC 116: 115V AC 126: 120V AC 26: 200/220V AC 236: 230V AC 246: 240V AC 386: 380V AC 46: 400/440V AC 486: 480V AC	Full Voltage Transformer

• Use a pure white LED lamp for yellow illumination.

Dimensions

ALFD2/AOLFD2
Full Voltage

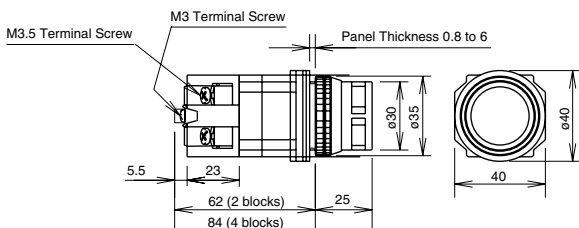

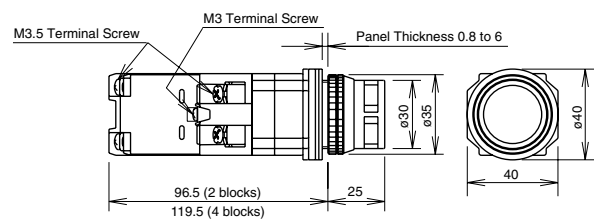

ALFD2/AOLFD2
Transformer



All dimensions in mm.

ø30 ø30 Diecast Zinc Series Illuminated Pushbuttons

ALD3 / AOLD3 Mushroom (ø40) Illuminated Pushbuttons

Shape	Lamp Receptacle	Operation	Lamp	Contact	Part No.	Applicable Lamp
ø40 Mushroom ALD3 AOLD3  	BA9S	Momentary	Without Lamp	1NO-1NC	ALD39911DN②	See page 75 for lamps.
				2NO	ALD39920DN②	
				2NC	ALD39902DN②	
			LED	1NO-1NC	ALD3③11DN②	LSTD-*②
				2NO	ALD3③20DN②	
				2NC	ALD3③02DN②	
		Maintained	Without Lamp	1NO-1NC	AOLD39911DN②	See page 75 for lamps.
				2NO	AOLD39920DN②	
				2NC	AOLD39902DN②	
			LED	1NO-1NC	AOLD3③11DN②	LSTD-*②
				2NO	AOLD3③20DN②	
				2NC	AOLD3③02DN②	

Color Code and Operating Voltage Code

Specify a code in place of ② and ③ in the Part No.

② Lens/LED Color Code	③ Operating Voltage Code	Input
A: amber G: green R: red W: white Y: yellow Use a pure white LED lamp for yellow illumination.	66: 6V AC/DC 11: 12V AC/DC 22: 24V AC/DC	Full Voltage
	16: 100/110V AC 116: 115V AC 126: 120V AC 26: 200/220V AC 236: 230V AC 246: 240V AC 386: 380V AC 46: 400/440V AC	Transformer

Dimensions

ALD3/AOLD3
Full Voltage

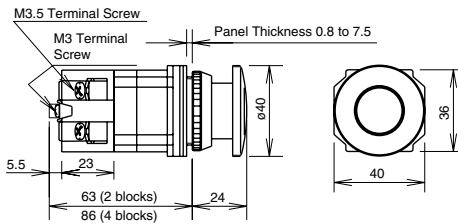

ALD3/AOLD3
Transformer

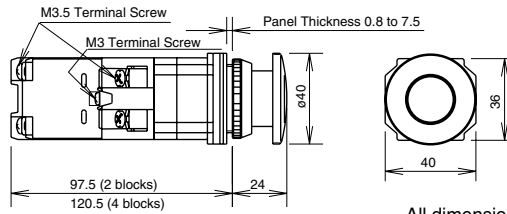

All dimensions in mm.

ø30 Diecast Zinc series Illuminated Pushbuttons ø30

AVLD3/ AVLDE3 Mushroom Pushlock Turn Reset Illuminated Pushbuttons

Shape	Lamp Receptacle	Lamp	Contact	Part No.	Applicable Lamp
Mushroom Pushlock Turn Reset AVLD3 AVLDE3 	BA9S	Without Lamp	1NO-1NC	AVLD39911NR	See page 75 for lamps.
			2NO	AVLD39920NR	
			2NC	AVLD39902NR	
		LED	1NO-1NC	AVLD3③11DNR	LSTD-*②
			2NO	AVLD3③20DNR	
			2NC	AVLD3③02DNR	
	Incandescent	1NO-1NC	AVLD3③11NR	LS-*	
		2NO	AVLD3③20NR		
		2NC	AVLD3③02NR		
	E12	Without Lamp	1NO-1NC	AVLDE39911NR	See page 75 for lamps.
			2NO	AVLDE39920NR	
			2NC	AVLDE39902NR	
LED		1NO-1NC	AVLDE3③11DNR	LETD-*②	
		2NO	AVLDE3③20DNR		
		2NC	AVLDE3③02DNR		
Incandescent	1NO-1NC	AVLD3③11NR (Note)	LE-*		
	2NO	AVLD3③20NR (Note)			
	2NC	AVLD3③02NR (Note)			

Color Code and Operating Voltage Code

Specify a code in place of ② and ③ in the Part No.

③ Operating Voltage Code			Input
LED	Incandescent (BA9S)	Incandescent (E12)	
66: 6V AC/DC 11: 12V AC/DC 22: 24V AC/DC	66: 6V AC/DC 88: 12V AC/DC 33: 24V AC/DC	66: 6V AC/DC 88: 12V AC/DC 33: 24V AC/DC	Full Voltage
16: 100/110V AC 116: 115V AC 126: 120V AC 26: 200/220V AC 236: 230V AC 246: 240V AC 386: 380V AC 46: 400/440V AC	16: 100/110V AC 116: 115V AC 126: 120V AC 26: 200/220V AC 236: 230V AC 246: 240V AC 386: 380V AC 46: 400/440V AC 486: 480V AC	18: 100/110V AC 118: 115V AC 128: 120V AC 238: 200/220V AC 238: 230V AC 248: 240V AC 388: 380V AC 48: 400/440V AC 488: 480V AC	Transformer

Note: When ordering 6V, 12V, 24V AC/DC units, specify "E" before the operating voltage code.
Example: AVLDE3③11NR

• Color code: R (red)

• **Pushlock Turn Reset:** Lens is maintained when pressed and is reset when turned clockwise. Red lens only.

Note: AVLD3 and AVLDE3 pushlock turn reset switches cannot be used as emergency stop switches. When emergency stop switches are required, use XN or HN series emergency stop switches (ISO 13850 and IEC 60947-5-5 compliant).

Dimensions

AVLD3
BA9S/Full Voltage

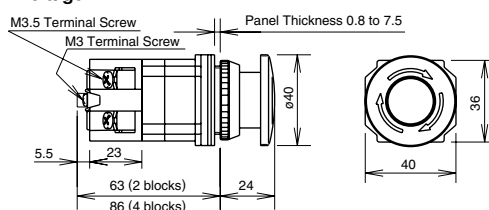

AVLD3
BA9S/Transformer

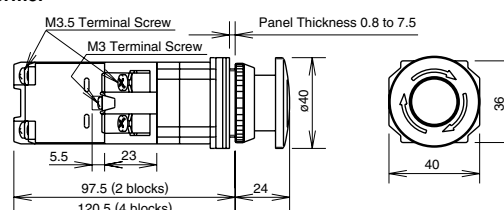

AVLDE3
E12/Full Voltage

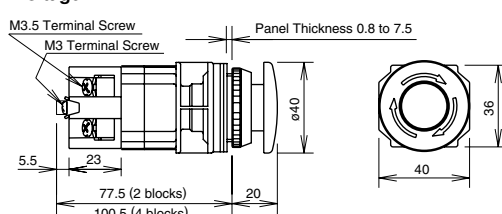



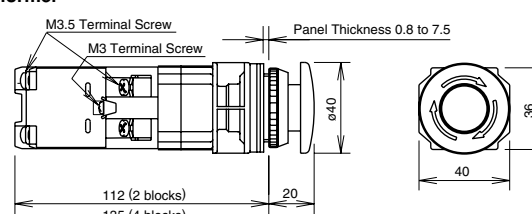





AVLD3/AVLDE3
E12/Transformer



All dimensions in mm.

ø30 ø30 Diecast Zinc Series Selector Switches

ASD Selector Switches (Knob Operator)

No. of Positions	Shape		ASD							
	Contact Arrangement Chart									
90° 2-position	Contact Code	Contact Block		Operator Position			Maintained	Spring Return from Right	Spring Return from Left	
		Mounting Position	Contact	L	R					
	10 (1NO)	1	NO		●		ASD210N	ASD2110N	ASD2210N *	—
		2	Dummy							
	11 (1NO-1NC)	1	NO		●		ASD211N	ASD2111N	ASD2211N *	
		2	NC	●						
	20 (2NO)	1	NO		●		ASD220N	ASD2120N	ASD2220N *	
		2	NO		●					
	22 (2NO-2NC)	1	NO		●		ASD222N	ASD2122N	ASD2222N *	
		2	NC	●						
3		NO	●							
4		NC	●							
45° 3-position	Contact Code	Contact Block		Operator Position			Maintained	Spring Return from Right	Spring Return from Left	Spring Return Two-way
		Mounting Position	Contact	L	C	R				
	20 (2NO)	1	NO	●			ASD320N	ASD3120N	ASD3220N	ASD3320N
		2	NO			●				
	40 (4NO)	1	NO	●			ASD340N	ASD3140N	ASD3240N	ASD3340N
		2	NO			●				
		3	NO	●						
		4	NO			●				
	22 (2NO-2NC)	1	NO	●			ASD322N	ASD3122N	ASD3222N	ASD3322N
		2	NO			●				
		3	NC			■				
		4	NC			■				
	02 (2NC)	1	NC			■	ASD302N	ASD3102N	ASD3202N	ASD3302N
		2	NC			■				
	04 (4NC)	1	NC			■	ASD304N	ASD3104N	ASD3204N	ASD3304N
		2	NC			■				
3		NC			■					
4		NC			■					

- Knob: Black
- Round bezel (metal): Chrome-plated
- Selector switches with one contact block contain a dummy block.
- On the 2-position selector switches marked with * above, the contact operation is reversed as follows.

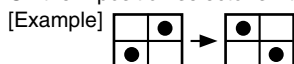

Contact Block Mounting Position and Contact Arrangement Chart



		Left	Center	Right	
		L	C	R	Operator Position
1	NO	●			
2	NO			●	
3	NC			■	
4	NC	■			



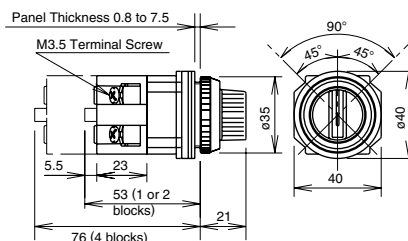









Dimensions



All dimensions in mm.

ø30 Diecast Zinc Series Selector Switches ø30

ASD□L Selector Switches (Lever Operator)

No. of Positions	Shape		ASD□L							
	Contact Arrangement Chart				   					
90° 2-position	Contact Code	Contact Block		Operator Position			Maintained	Spring Return from Right	Spring Return from Left	
		Mounting Position	Contact	L	R					
	10 (1NO)	1	NO		●		ASD2L10N	ASD21L10N	ASD22L10N *	—
		2	Dummy							
	11 (1NO-1NC)	1	NO		●		ASD2L11N	ASD21L11N	ASD22L11N *	
		2	NC	●						
	20 (2NO)	1	NO		●		ASD2L20N	ASD21L20N	ASD22L20N *	
		2	NO		●					
	22 (2NO-2NC)	1	NO		●		ASD2L22N	ASD21L22N	ASD22L22N *	
		2	NC	●						
3		NO	●							
4		NC	●							
45° 3-position	Contact Code	Contact Block		Operator Position			Maintained	Spring Return from Right	Spring Return from Left	Spring Return Two-way
		Mounting Position	Contact	L	C	R				
	20 (2NO)	1	NO	●			ASD3L20N	ASD31L20N	ASD32L20N	ASD33L20N
		2	NO			●				
	40 (4NO)	1	NO	●			ASD3L40N	ASD31L40N	ASD32L40N	ASD33L40N
		2	NO			●				
		3	NO	●						
		4	NO			●				
	22 (2NO-2NC)	1	NO	●			ASD3L22N	ASD31L22N	ASD32L22N	ASD33L22N
		2	NO			●				
		3	NC			■				
		4	NC	■						
	02 (2NC)	1	NC			■	ASD3L02N	ASD31L02N	ASD32L02N	ASD33L02N
		2	NC	■						
	04 (4NC)	1	NC			■	ASD3L04N	ASD31L04N	ASD32L04N	ASD33L04N
		2	NC	■						
		3	NC			■				
		4	NC	■						

- Lever: Black
- Round bezel (metal): Chrome-plated
- Selector switches with one contact block contain a dummy block.
- On the 2-position selector switches marked with * above, the contact operation is reversed as follows.

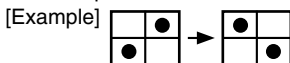

Contact Block Mounting Position and Contact Arrangement Chart



		Left	Center	Right	
		L	C	R	Operator Position
1	NO	●			
2	NO			●	
3	NC			■	
4	NC	■			



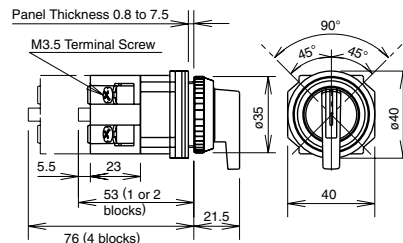









Dimensions



All dimensions in mm.

ø30 ø30 Diecast Zinc Series Selector Switches

ASD□K Key Selector Switches

No. of Positions	Shape		ASD□K							
	Contact Arrangement Chart				   					
90° 2-position	Contact Code	Contact Block		Operator Position			Maintained	Spring Return from Right	Spring Return from Left	—
		Mounting Position	Contact	L	R					
	10 (1NO)	1	NO		●		ASD2K10N	ASD21K10N	ASD22K10N *	
		2	Dummy							
	11 (1NO-1NC)	1	NO		●		ASD2K11N	ASD21K11N	ASD22K11N *	
		2	NC	●						
	20 (2NO)	1	NO			●	ASD2K20N	ASD21K20N	ASD22K20N *	
		2	NO			●				
	22 (2NO-2NC)	1	NO		●		ASD2K22N	ASD21K22N	ASD22K22N *	
		2	NC	●						
3		NO			●					
4		NC	●							
45° 3-position	Contact Code	Contact Block		Operator Position			Maintained	Spring Return from Right	Spring Return from Left	Spring Return Two-way
		Mounting Position	Contact	L	C	R				
	20 (2NO)	1	NO	●			ASD3K20N	ASD31K20N	ASD32K20N	ASD33K20N
		2	NO			●				
	40 (4NO)	1	NO	●			ASD3K40N	ASD31K40N	ASD32K40N	ASD33K40N
		2	NO			●				
		3	NO	●						
		4	NO			●				
	22 (2NO-2NC)	1	NO	●			ASD3K22N	ASD31K22N	ASD32K22N	ASD33K22N
		2	NO			●				
		3	NC			■				
		4	NC			■				
	02 (2NC)	1	NC			■	ASD3K02N	ASD31K02N	ASD32K02N	ASD33K02N
		2	NC			■				
	04 (4NC)	1	NC			■	ASD3K04N	ASD31K04N	ASD32K04N	ASD33K04N
		2	NC			■				
3		NC			■					
4		NC			■					

- Cylinder: Black
- Round bezel (metal): Chrome-plated
- On the spring-returned, the keys can be released only from the maintained positions. On the maintained, the key can be released from every position. Key retained positions are also available. See page 81.
- Key selector switches are supplied with two standard keys.
- Key selector switches with one contact block contain a dummy block.
- On the 2-position selector switches marked with * above, the contact operation is reversed as follows.

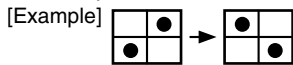

Contact Block Mounting Position and Contact Arrangement Chart

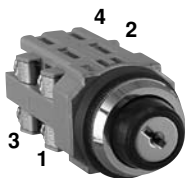

		Left	Center	Right	
		L	C	R	Operator Position
1	NO	●			
2	NO			●	
3	NC			■	
4	NC	■			

Dimensions

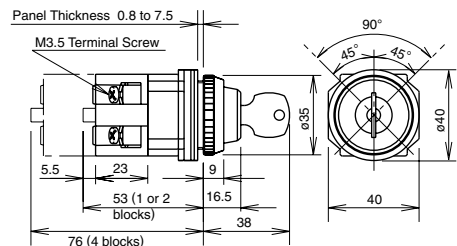





All dimensions in mm.

ø30 Diecast Zinc Series Illuminated Selector Switches ø30

ASLD Illuminated Selector Switches

90° 2-position

Shape		ASLD (Base BA9S)						
Contact Arrangement Chart								
								
Contact Code	Contact Block		Operator Position		Lamp	Maintained	Spring Return from Right	Spring Return from Left
	Mounting Position	Contact	L	R				
11 (1NO-1NC)	1	NO		●	Without Lamp	ASLD29911N②	ASLD219911N②	ASLD229911N② *
	2	NC	●		LED	ASLD2③11DN②	ASLD21③11DN②	ASLD22③11DN② *
					Incandescent	ASLD2③11N②	ASLD21③11N②	ASLD22③11N② *
20 (2NO)	1	NO		●	Without Lamp	ASLD29920N②	ASLD219920N②	ASLD229920N② *
	2	NO		●	LED	ASLD2③20DN②	ASLD21③20DN②	ASLD22③20DN② *
					Incandescent	ASLD2③20N②	ASLD21③20N②	ASLD22③20N② *
22 (2NO-2NC)	1	NO		●	Without Lamp	ASLD29922N②	ASLD219922N②	ASLD229922N② *
	2	NC	●					
	3	NO		●	LED	ASLD2③22DN②	ASLD21③22DN②	ASLD22③22DN② *
	4	NC	●					
				Incandescent	ASLD2③22N②	ASLD21③22N②	ASLD22③22N② *	

Color Code and Operating Voltage Code

Specify a code in place of ② or ③ in the Part No.

② Lens/LED Color Code		③ Operating Voltage Code		Input
LED	Incandescent	LED	Incandescent	
A: amber G: green R: red S: blue W: white Y: yellow	A: amber G: green R: red S: blue W: white	66: 6V AC/DC 11: 12V AC/DC 22: 24V AC/DC	66: 6V AC/DC 88: 12V AC/DC 33: 24V AC/DC	Full voltage
Use a pure white LED lamp for yellow illumination		16: 100/110V AC 156: 115V AC 136: 120V AC 26: 200/220V AC 236: 230V AC 256: 240V AC 386: 380V AC 46: 400/440V AC	16: 100/110V AC 156: 115V AC 136: 120V AC 26: 200/220V AC 236: 230V AC 256: 240V AC 386: 380V AC 46: 400/440V AC 486: 480V AC	Transformer

• On the 2-position selector switches marked with * above, the contact operation is reversed as follows.

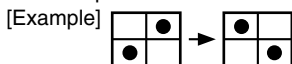

Contact Block Mounting Position and Contact Arrangement Chart

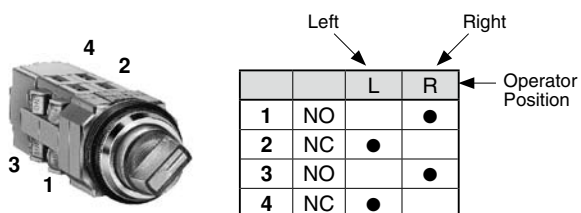

Dimensions

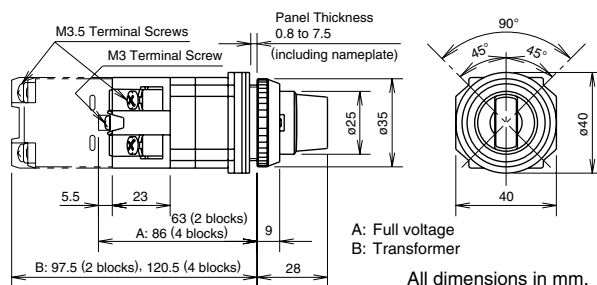

ø30 ø30 Diecast Zinc Series Illuminated Selector Switches

ASLD Illuminated Selector Switches

45° 3-position

Contact Code	Contact Block		Operator Position			Lamp	Maintained	Spring Return from Right	Spring Return from left	Spring Return Two-way
	Mounting Position	Contact	L	C	R		L C R	L C R	L C R	L C R
20 (2NO)	1	NO	●			Without Lamp	ASLD39920N②	ASLD319920N②	ASLD329920N②	ASLD339920N②
	2	NO			●	LED	ASLD3③20DN②	ASLD31③20DN②	ASLD32③20DN②	ASLD33③20DN②
						Incandescent	ASLD3③20N②	ASLD31③20N②	ASLD32③20N②	ASLD33③20N②
02 (2NC)	1	NC		■		Without Lamp	ASLD39902N②	ASLD319902N②	ASLD329902N②	ASLD339902N②
	2	NC	■			LED	ASLD3③02DN②	ASLD31③02DN②	ASLD32③02DN②	ASLD33③02DN②
						Incandescent	ASLD3③02N②	ASLD31③02N②	ASLD32③02N②	ASLD33③02N②
22 (2NO-2NC)	1	NO	●			Without Lamp	ASLD39922N②	ASLD319922N②	ASLD329922N②	ASLD339922N②
	2	NO			●					
	3	NC		■		LED	ASLD3③22DN②	ASLD31③22DN②	ASLD32③22DN②	ASLD33③22DN②
	4	NC	■							
					Incandescent	ASLD3③22N②	ASLD31③22N②	ASLD32③22N②	ASLD33③22N②	
40 (4NO)	1	NO	●			Without Lamp	ASLD39940N②	ASLD319940N②	ASLD329940N②	ASLD339940N②
	2	NO			●					
	3	NO	●			LED	ASLD3③40DN②	ASLD31③40DN②	ASLD32③40DN②	ASLD33③40DN②
	4	NO			●					
					Incandescent	ASLD3③40N②	ASLD31③40N②	ASLD32③40N②	ASLD33③40N②	
04 (4NC)	1	NC		■		Without Lamp	ASLD39904N②	ASLD319904N②	ASLD329904N②	ASLD339904N②
	2	NC	■							
	3	NC		■		LED	ASLD3③04DN②	ASLD31③04DN②	ASLD32③04DN②	ASLD33③04DN②
	4	NC	■							
					Incandescent	ASLD3③04N②	ASLD31③04N②	ASLD32③04N②	ASLD33③04N②	

Color Code and Operating Voltage Code

Specify a code in place of ② or ③ in the Part No.

② Lens/LED Color Code		③ Operating Voltage Code		Input Type
LED	Incandescent	LED	Incandescent	
A: amber G: green R: red S: blue W: white Y: yellow	A: amber G: green R: red S: blue W: white	66: 6V AC/DC 11: 12V AC/DC 22: 24V AC/DC	66: 6V AC/DC 88: 12V AC/DC 33: 24V AC/DC	Full voltage
Use a pure white LED lamp for yellow illumination		16: 100/110V AC 156: 115V AC 136: 120V AC 26: 200/220V AC 236: 230V AC 256: 240V AC 386: 380V AC 46: 400/440V AC	16: 100/110V AC 156: 115V AC 136: 120V AC 26: 200/220V AC 236: 230V AC 256: 240V AC 386: 380V AC 46: 400/440V AC 486: 480V AC	Transformer

Contact Block Mounting Position and Contact Arrangement Chart

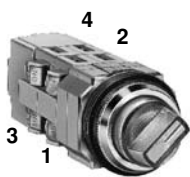



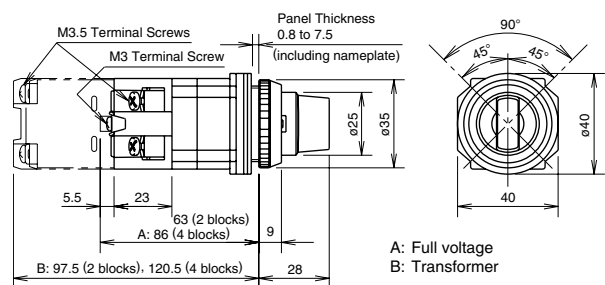

	Left	Center	Right	Operator Position
1	NO	●		
2	NO		●	
3	NC		■	
4	NC	■		

Dimensions



ø30 Diecast Zinc Series Selector Pushbuttons ø30

ASBD2 Ring Operator / ASBD2L Lever Operator Selector Pushbuttons

Shape	Contact Code	Circuit Code	Contact Block	Ring/Lever				Ring Operator Part No.	Lever Operator Part No.	Color		
				Pushbutton		Normal	Push				Normal	Push
				Mounting Position	Contact							
Ring Operator (90° 2-Position) ASBD2   Lever Operator (90° 2-Position) ASBD2L  	11 (1NO-1NC)	A03	1	NO		●		●	ASBD211N-A03①	ASBD2L11N-A03①	B: black G: green R: red Y: yellow	
			2	NC	●							
		G03	1	NO		●		Blocked	ASBD211N-G03①	ASBD2L11N-G03①		
			2	NC	●		●					
	22 (2NO-2NC)	A08	1	NO		●		ASBD222N-A08①	ASBD2L22N-A08①			
			2	NC	●							
			3	NO		●						
			4	NC	●							
	C10	1	NO		●		ASBD222N-C10①	ASBD2L22N-C10①				
		2	NO			●						
		3	NC	●								
		4	NC	■								
	D10	1	NO		●		ASBD222N-D10①	ASBD2L22N-D10①				
		2	NO			●						
		3	NC	●		■						
		4	NC	■		●						
E10	1	NO		●		ASBD222N-E10①	ASBD2L22N-E10①					
	2	NO			●							
	3	NC			■							
	4	NC	■									
F10	1	NO		●		ASBD222N-F10①	ASBD2L22N-F10①					
	2	NO		●								
	3	NC			●							
	4	NC	●									
G10	1	NO		●		ASBD222N-G10①	ASBD2L22N-G10①					
	2	NO		●								
	3	NC	●		●							
	4	NC	●		●							

- Specify a button color code in place of ① in the Part No.
- Ring/Lever (Metal): Chrome-plated

Notes:

1. Circuit Code G: The pushbutton does not operate when the ring or lever operator is turned to the right position.
2. Circuit Codes E and F: The right and left NC contact blocks on circuit code E or F may overlap each other while turning the ring or lever operator. The NO and NC contact blocks on circuit code F may overlap each other while pressing the button.
3. When using the selector pushbutton, do not turn the ring or lever operator with the pushbutton depressed. Otherwise, damage or failure may be caused.
4. When installing the lever operator, make sure that the lever is not in the horizontal position. Otherwise, shock resistance may be degraded.

Contact Block Mounting Position and Contact Arrangement Chart



	Normal	Push
1		●
2	●	
3		●
4	●	

Dimensions

Ring Operator (90° 2-position) ASBD2

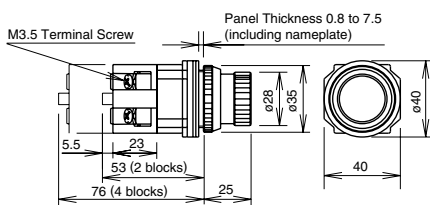

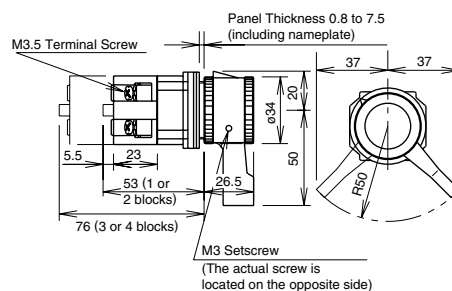

Lever Operator (90° 2-position) ASBD2L





ø30 ø30 Diecast Zinc Series Accessories and Replacement Parts

Accessories (For Diecast Zinc Series Only)

For other accessories, see pages 67 to 76.

Shape	Material	Part No.	Ordering No.	Package Quantity	Description
 Flush (Octagonal) Extended (Octagonal)	Chrome-plated	OG-81	OG-81PN02	2	• Cannot be used with half-shrouds.
		OG-82	OG-82	1	
 Spare Key	Metal	TW-SK-0	TW-SK-0PN02	2	• For key selector switches

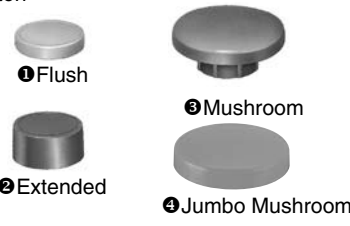
Maintenance Parts (For Diecast Zinc Series Only)

Shape	Specification	Part No.	Ordering No.	Package Quantity	Description
 ① Flush ③ Mushroom ② Extended ④ Jumbo Mushroom	Plastic	① ABN1BN-①	ABN1BN-①PN05	5	Specify a color code in place of ①. B (black), G (green), R (red), S (blue), W (white), Y (yellow) • Above colors are used for ø30 diecast zinc control units (light colored operator units).
		② ABN2BN-①	ABN2BN-①PN05	5	
		③ ABN3BN-①	ABN3BN-①PN02	2	
		④ ABN4BN-①	ABN4BN-①	1	
 Dummy Block	Plastic	BST-D	BST-DPN10	10	• Used for 1NO or 1NC contact blocks. • Snaps on to the operator unit.
 ① Knob ② Lever ③ Color Insert	Plastic	① ASNHT-①	ASNHT-①PN02	2	Specify a color code in place of ①. B (blue), G (green), R (red)
		② ASNHL-①	ASNHL-①PN02		
	Plastic	③ TW-HC1①	TW-HC1①PN05	5	Specify a color code in place of ①. B (black), G (green), R (red), S (blue), W (white), Y (yellow)

Safety Precautions

- Turn off the power to the ø30 diecast zinc control units before starting installation, removal, wiring, maintenance, and starting installation, removing, wiring, maintenance, and inspection of the products. Failure to turn power off may cause electrical shocks or fire hazard.
- To avoid a burn on your hand, use the lamp holder tool when replacing lamps.
- For wiring, use wires of a proper size to meet the voltage and current requirements. Tighten the M3.5 terminal screws to a tightening torque of 1.0 to 1.3 N·m. Failure to tighten terminal screws may cause overheat and fire.

Instructions

Tightening Torque for Terminal Screws

Tighten the M3.5 terminal screws to a torque of 1.0 to 1.3 N·m.

Replacement of Lamps

Lamps can be replaced by using the lamp holder tool (OR-55) from the front of the panel.

• How to remove

To remove, slip the lamp holder tool onto the lamp head lightly. Then push slightly, and turn the lamp holder tool counterclockwise.

• How to install

To install, insert the lamp head into the lamp holder tool. Place the pins on the lamp base to the grooves in the lamp socket. Inset the lamp and turn it clockwise.

Installation of LED Illuminated Units

- When using full voltage LED illuminated units, provide protection against electrical noise, if necessary. See page 78 for notes on LED illuminated units.



OR-55



Specifications and other descriptions in this catalog are subject to change without notice.



IDEC CORPORATION

7-31, Nishi-Miyahara 1-Chome, Yodogawa-ku, Osaka 532-8550, Japan
Tel: +81-6-6398-2571, Fax: +81-6-6392-9731
E-mail: marketing@iddec.co.jp

IDEC CORPORATION (USA)
Tel: +1-408-747-0550 / (800) 262-IDEC (4332)
E-mail: opencontact@iddec.com
IDEC CANADA LIMITED
Tel: +1-905-890-8561, Toll Free: (888) 317-4332
E-mail: sales@ca.iddec.com
IDEC AUSTRALIA PTY. LTD.
Tel: +61-3-8523-5900, Toll Free: 1800-68-4332
E-mail: sales@au.iddec.com

IDEC ELECTRONICS LIMITED
Tel: +44-1256-321000 E-mail: sales@uk.iddec.com
IDEC ELEKTROTECHNIK GmbH
Tel: +49-40-25 30 54 - 0 E-mail: service@iddec.de
IDEC (SHANGHAI) CORPORATION
Tel: +86-21-6135-1515 E-mail: idec@cn.iddec.com
IDEC (BEIJING) CORPORATION
Tel: +86-10-6581-6131

IDEC (SHENZHEN) CORPORATION
Tel: +86-755-8356-2977
IDEC IZUMI (H.K.) CO., LTD.
Tel: +852-2803-8989 E-mail: info@hk.iddec.com
IDEC TAIWAN CORPORATION
Tel: +886-2-2698-3929 E-mail: service@tw.iddec.com
IDEC IZUMI ASIA PTE. LTD.
Tel: +65-6746-1155 E-mail: info@sg.iddec.com

www.idec.com