

The ALCO PS3 is a Pressure Switch with fixed switch-point settings.

Features

- Maximum Operating Pressure up to 43 bar
- Test Pressure up to 48 bar
- Standard factory settings from stock in small volumes
- High and low pressure switches
- High temperature version with snubber for direct compressor mounting (Range 6)
- Direct mounting reduces the number of joints and thus avoiding potential leakage
- Precise setting and repeatability
- IP 65 protection if used with the new PS3-Nxx and PS3-Lxx cables with plug (acc. EN 175301-803), no additional gasket required (molded into plug)
- Customer specific versions in multipacks, minimum order quantity 100 Stück





Options

- For direct mounting on a pressure connection (free standing) or with a capillary tube
- Direct compressor head mounting with high temperature bellows and snubber:
 - reduces the number of joints
 - avoids potential leakage
 - saves high cost of flexible hose
- TÜV approved versions for high and low pressure
- Micro-switch for narrow pressure differentials
- Gold plated contacts for low voltage/current applications
- Cables with plug PS3-Nxx/PS3-Lxx not included; to be ordered separately (see page 8 for details)



PS3

Standards

-  per Low Voltage Directive
-  per PED Directive 97/23/EC, TÜV appr. versions only
- Manufactured and tested to  standards on our own responsibility
-  Underwriter Laboratories

Introduction

PS3 are equipped with a SPDT snap action contact, switching from 1-2 to 1-4 on rising pressure and from 1-4 to 1-2 on falling pressure (see diagram). The PS3 is factory preset according to customers specification and is not adjustable. Several models are available:

- Low pressure switch, with automatic or manual reset
- High pressure switch, with automatic or manual reset
- TÜV approved safety high pressure limiter with automatic reset
- TÜV approved safety high pressure cut-out, with internal or external manual reset

TÜV approval for pressure switches can be reached either by using a double diaphragm (Pressure range 1-5) which acts in a fail-safe mode or by a single pressure element (Bellows, Pressure range 6) which is able to resist to > 2 Mio. cycles between 50% and 100% of the maximum operating pressure (see 4.6.1 of EN 12263).

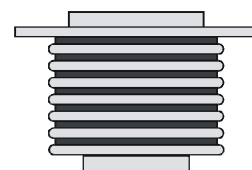
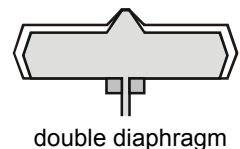
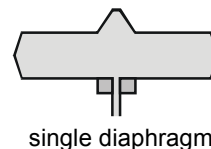
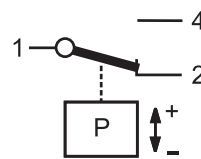

bellows (pressure range 6)

D A T A S H E E T

Technical data

Pressure sensing element

Type of diaphragm	Max. medium temperature	Construction	Material	Snubber	Pressure Ranges	TÜV approval	Function Code *	Possible Pressure Conn.
Standard temperature	+ 70° C	Single diaphragm	Bronze	no	1-5	No	A,R	A,K,L,S,U,X
		Double diaphragm	Bronze	no	1-5	Yes	B,S,W	A,K,L,S,U,X
High temperature	+ 150° C	Bellows	Stainless steel	yes	6	Yes	B,S,W	S,U,X
					6	no	A,R	S,U,X

*) see page 7 for more details.

Note: For high temperature applications, i. e. medium temperatures between 70 °C and 150 °C, the maximum ambient temperature must be derated as per drawing.

E.g.: on medium temperature 120 °C the ambient temperature of 55 °C around the switch housing should not be exceeded.

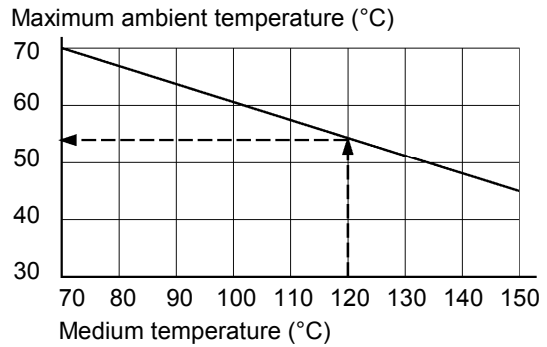

	Standard (SPDT)	Standard (SPDT) Gold plated contacts	Micro switch (SPDT)	Micro switch(SPDT) Gold plated Contacts
Inductive load (AC15)	3A / 230VAC	0,1A / 230VAC	1.5A / 230VAC	0,1A / 230VAC
Inductive load (DC)	0,1A / 230VDC	0,1A / 230VDC	0.1A / 230VDC	0,1A / 230VDC
Motor rating amps (FLA)	6A / 120 / 240VAC	-	2.5A / 120 / 240VAC	-
Lock rotor amps (LRA)	36A / 120 / 240VAC	-	15A / 120 / 240VAC	-

Note: Standard contact not suitable for electronic applications (< 100 mA)

Protection class (IEC 529) with terminal cover	IP 00	Temperature range TS: ambient, storage and transportation medium	-40°C to 70°C -40°C to 70°C -40°C to 150°C for Range 6
with appliance socket or cables with plug PS3-Nxx / -Lxx / -215 / -415	IP 30 IP 65		
Resistance to vibration (at 10..1000 Hz)	4g	Available approvals	TÜV, UL
Medium compatibility *	HFC, HCFC	Weight (approx.)	0.1 kg

*) NOTE: PS3 are not released for use with inflammable refrigerants.

Pressure Ranges

Pressure Range code	Type of contact	Adjusting Range (bar)	Max. Operating Pressure PS (bar)	Proof Press. PT (bar)	Differential reset (bar)	Differential automatic (bar)
1 / A	Standard (SPDT)	-0.6 .. 6	27	30	approx. 1,3	see charts on page 4 - 6
3 / C		0.1 .. 16				
4 / D and 5 / E		6 .. 30	31	36	approx. 4	
6 / F		10 .. 43	43	48	approx. 5	
J / S	Micro switch (SPDT)	-0.6 .. 6	27	30		approx. 0.2 to 0.3
L / U		0.1 .. 16				approx. 0.3 to 0.45
N / W		6 .. 30	31	36		approx. 0.4 to 0.6
O / X		10 .. 43	43	48		approx. 0.5 to 0.8

Tolerances (bar)

Range code	1 / J	3 / L	4	5 / N	6 / O	4,5,6 (TÜV appr.)
Setting	±0.16	±0.4	±0.8	±0.8	±0.8	according to EN 12 263

Tolerances are valid between -20...+55°C.

Selection

1. Preferred types

Type	PCN	Fixed setting (bar)		Reset	Max. temperature		Leakage test pressure (bar)	Pressure connection
		Cut-out	Cut-in		ambient	pressure connection		

High Pressure Controls

PS3-A6S	0 715 603	16,0	11,0	Auto	+ 70°C	+ 150°C	48	7/16"-20 UNF female thread with Schrader opener
PS3-A6S	0 715 604	19,0	15,0					
PS3-A6S	0 715 600	26,5	22,5					

Low Pressure Controls / Pressure Limiter for low pressure protection PSL EN 12263

PS3-W1S	0 714 760	-0,3	1,2	Auto	+ 70°C	+ 70°C	30	7/16"-20 UNF female thread with Schrader opener
PS3-W1S	0 714 761	0,3	1,8					
PS3-W1S	0 714 762	2,0	3,5					

Pressure Limiter for high pressure protection PSH with snubber for direct compressor mounting EN 12263

PS3-W6S	0 715 831	14,0	10,0	Auto	+ 70°C	+ 150°C	48	7/16"-20 UNF female thread with Schrader opener and snubber
PS3-W6S	0 715 556	21,0	16,0					
PS3-W6S	0 715 555	25,0	20,0					
PS3-W6S	0 715 567	29,0	23,0					
PS3-W6S	0 715 550	33,5	27,5					
PS3-W6S	0 715 553	40,0	33,0					

Pressure Cut Out for high pressure protection PZH with snubber for direct compressor mounting EN 12263

PS3-B6S	0 715 568	19,2	appr. 5 bar cut-out	external manual reset	+ 70°C	+ 150°C	48	7/16"-20 UNF female thread with Schrader opener and snubber
PS3-B6S	0 715 564	22,7						
PS3-B6S	0 715 563	27,3						
PS3-B6S	0 715 569	29,5						
PS3-B6S	0 715 560	36,0						

Delivery: small quantities, single package without plug (Cables with plug must be ordered separately, see page 8)

2. Customer specific types

Minimum batch size: 100 pieces

Switching points

The differential of factory set switch points can be adjusted within the limits given in the charts on page 4 to 6. Use the recommended lower switch point line in working envelope for optimum results.

Example:

- Step 1: Select your desired upper switch point P₁. Draw a horizontal line to cross the upper switch point line.
- Step 2: Draw a vertical line from this intersection point.
- Step 3: Select your desired switch point between P₂ and P₄.

Notes:

- Specify always upper and lower switching points for pressure switch with automatic reset function.
- Specify only cut-out switching point for pressure switch with manual reset function.
- For versions with micro-switch only one switching point can be adjusted while the second switching point is determined by the fixed differential of the micro-switch (see Pressure Ranges on page 2).

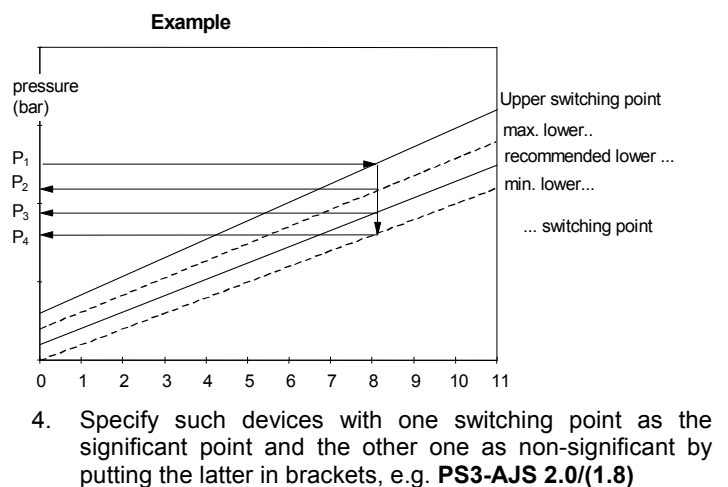

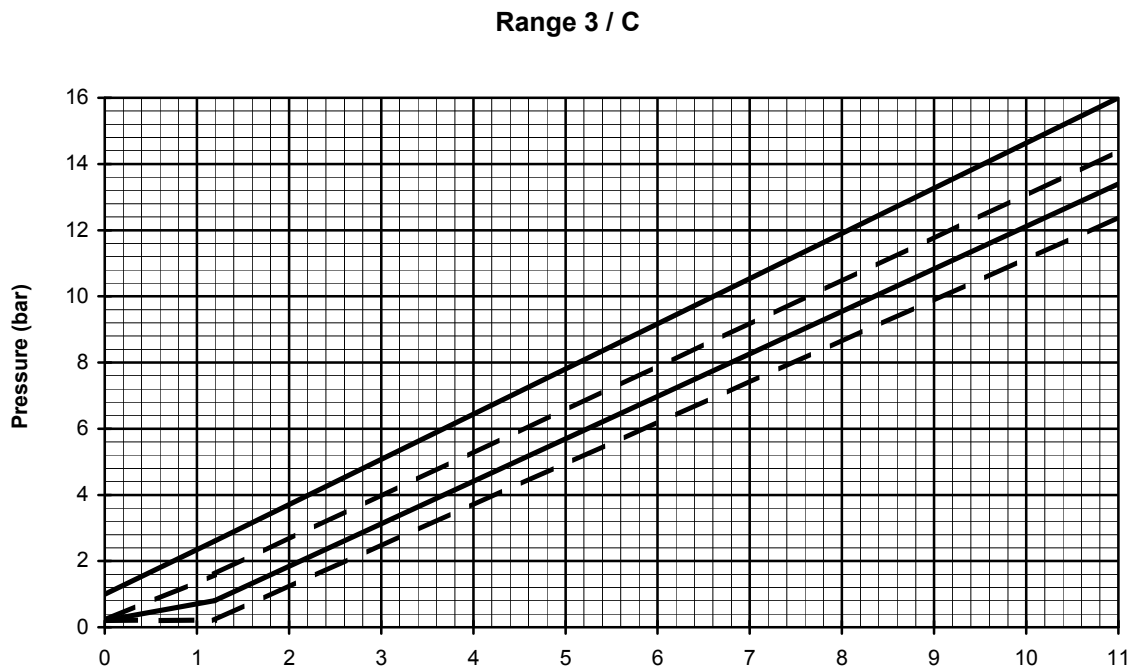
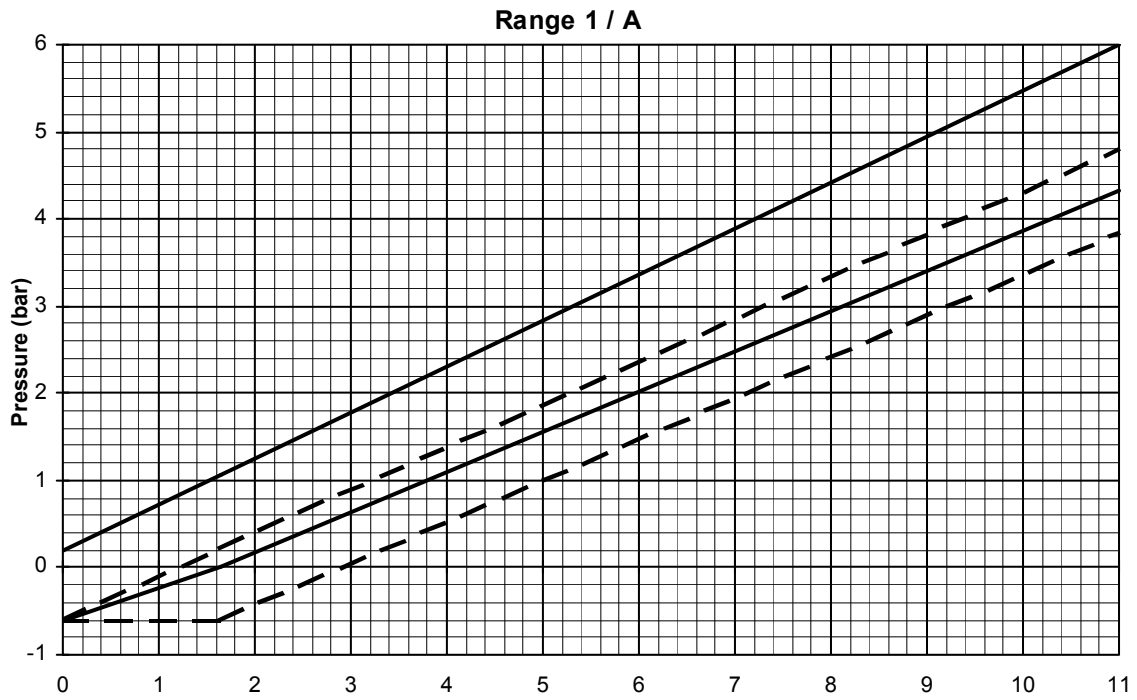

Range 4 / D

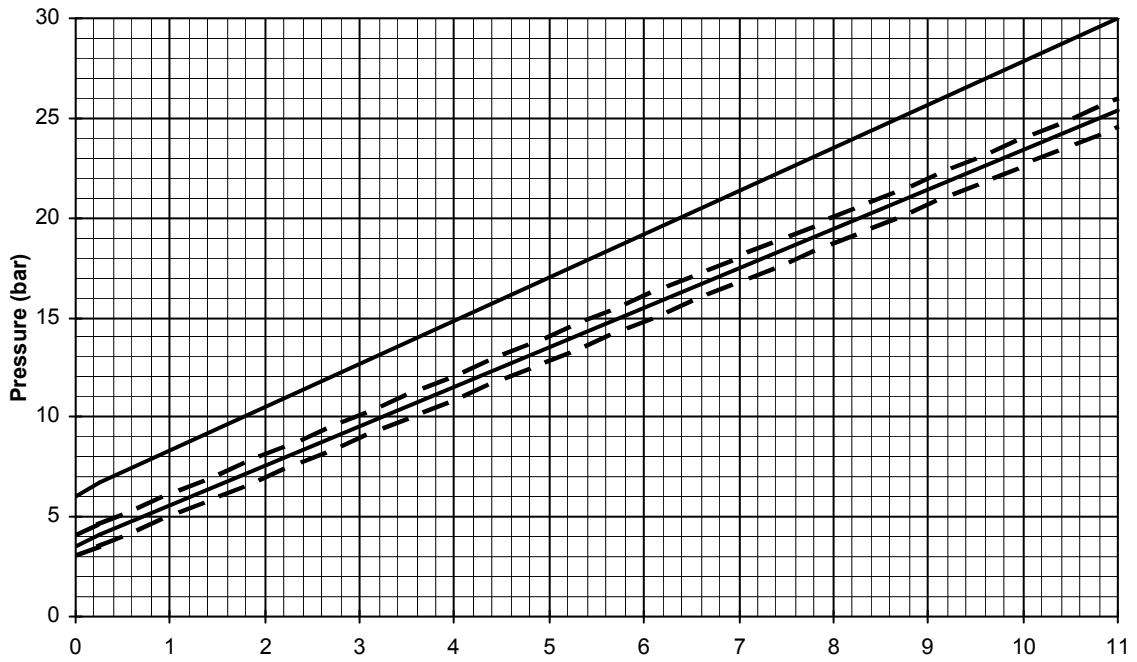

Range 5 / E

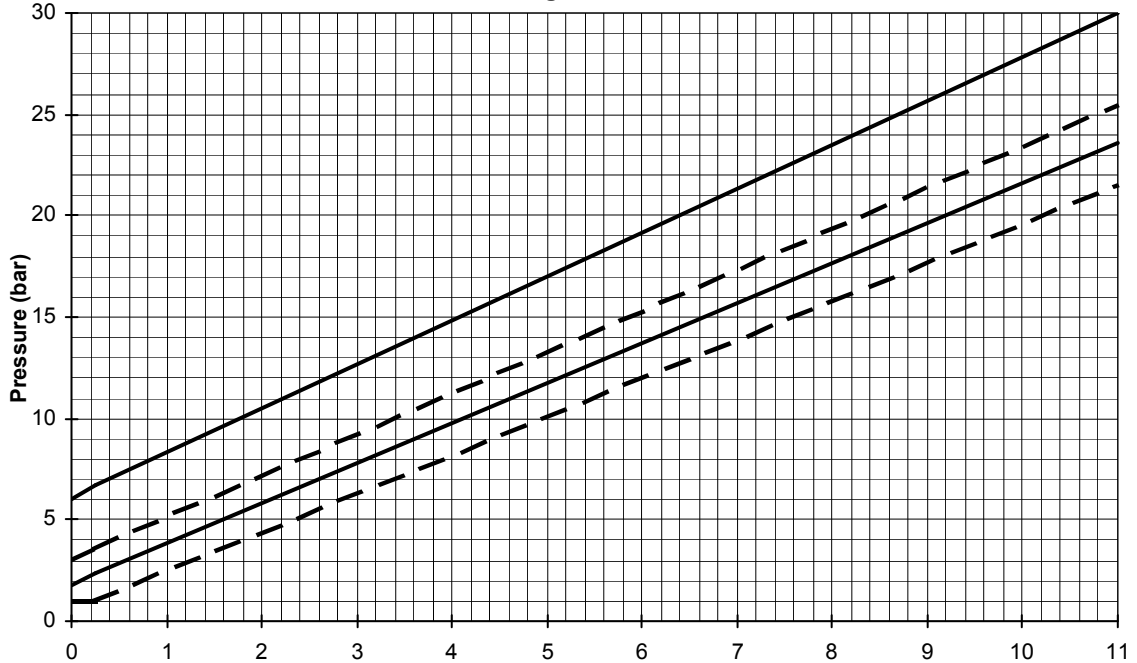

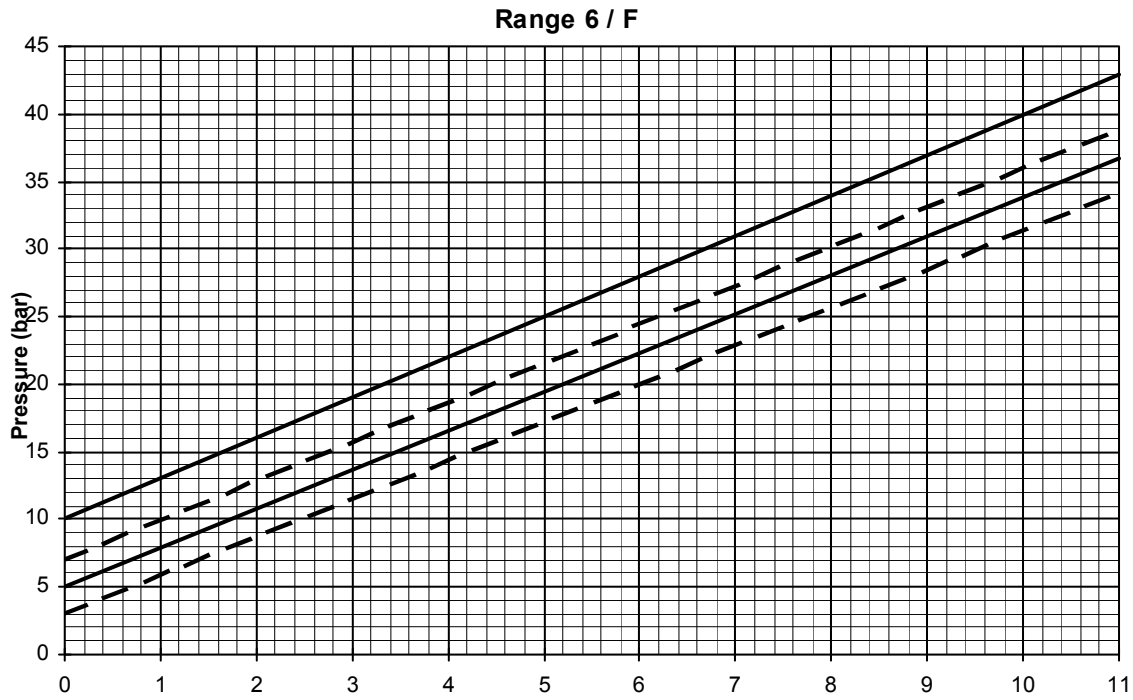

Selection guide

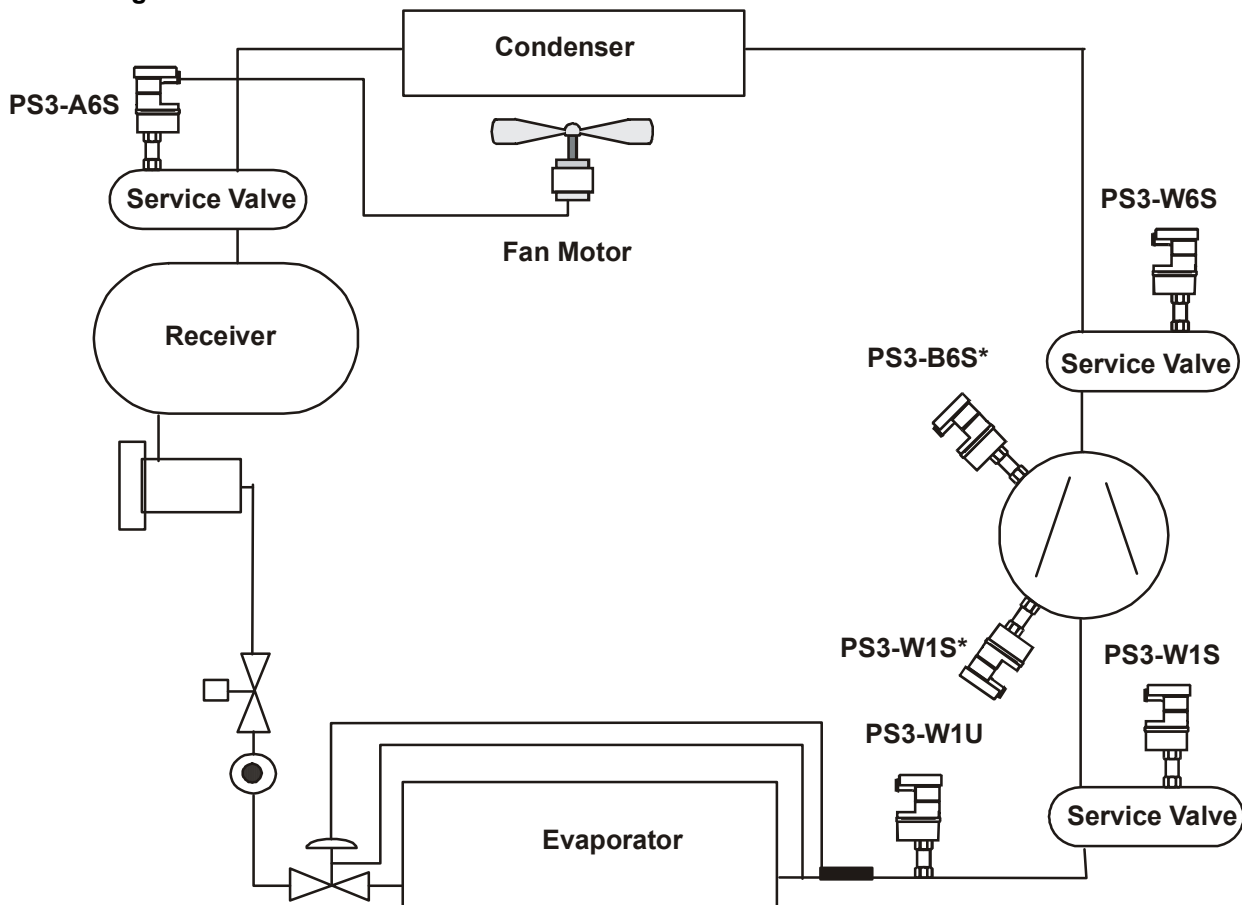

*) Requires additional adapter such as: 1/8 or 1/4 NPT by 7/16-20 UNF flare male (see Other Accessories on page 8)

Selection Sheet

For selection and sample request please fill-in complete

Note: not each combination is possible

Type code

PS3 -

--	--	--

- cut-in / cut-out

Product Name

PS3: Compact fixed setting pressostat
PSC: Customer special version of PS3

Function

A: Pressure control, automatic, hp and lp
R: Pressure control, external manual reset, hp and lp
W: Pressure limiter, automatic TÜV Range 1-5 (high temperature Range 6, O, F, X only)
B: Pressure cut-out, external manual reset TÜV Range 1-5 (high temperature, Range 6, O, F, X only)
S: Safety pressure cut-out, internal manual reset TÜV Range 1-5 (high temperature, Range 6, O, F, X only)

Pressure Connectors

A: 7/16"-20 UNF male (Range 1-5), with console
G: G1/4" female brass
K: 1 m cap. tube w. flare nut 7/16"-20UNF (Range 1-5), with console
L: 1/4"-ODM solder with 1 m cap. tube (Range 1-5), with console
R: G1/4" male brass
S: 7/16"-20 UNF female, Schrader depressor (Range 6 with snubber)
U: 6 mm ODF brazing, with console (Range 6 with snubber)
X: 1/4" ODF brazing, with console (Range 6 with snubber)

Pressure Range / Contacts

Standard Contacts

1: lp max 6 bar
3: lp max 16 bar
4: hp max 30 bar
5: hp max 30 bar
6: hp max 43 bar

Microswitch

J: lp max 6 bar
L: lp max 16 bar
M: hp max 30 bar
N: hp max 30 bar
O: hp max 43 bar

Gold Plated Contacts

A: lp max 6 bar
C: lp max 16 bar
D: hp max 30 bar
E: hp max 30 bar
F: hp max 43 bar

Microswitch(Gold Plated Contacts)

S: lp max 6 bar
U: lp max 16 bar
V: hp max 30 bar
W: hp max 30 bar
X: hp max 43 bar

Accessories

Cables with Plug for PS3, gasket molded into plug (IP 65)



Type	PCN	No of leads	Diameter of leads	Temperature Range °C	Cable length mtr.
PS3-N15	804 580	3	0.75 mm2	-25/+80	1.5
PS3-N30	804 581				3.0
PS3-N60	804 582				6.0
PS3-L15	804 583	3	0.75 mm2	-50/+80	1.5
PS3-L30	804 584				3.0
PS3-L60	804 585				6.0
PS3-215	804 587	2	0.75 mm2	-25/+80	1.5
PS3-415	804 588				1.5

The following pictures show the different types of application:

(Pin numbers from PS3 – see below, bk = black, bl = blue, br = brown)

High Pressure Application

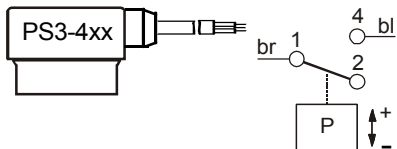
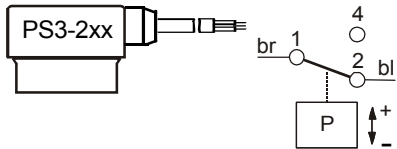
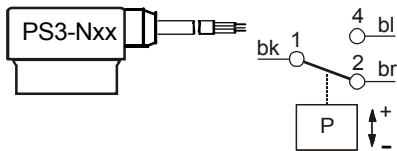

Low Pressure Application

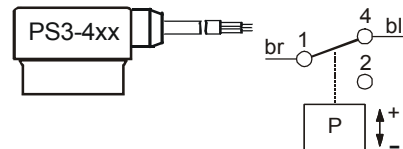
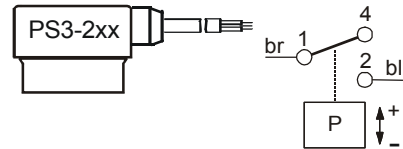
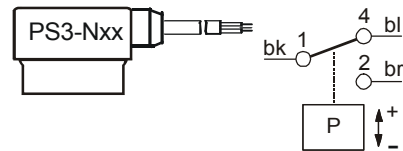

PS3 – Pins

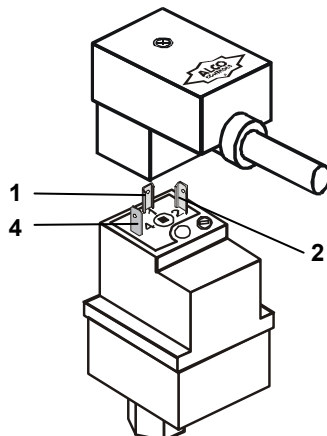

Other Accessories

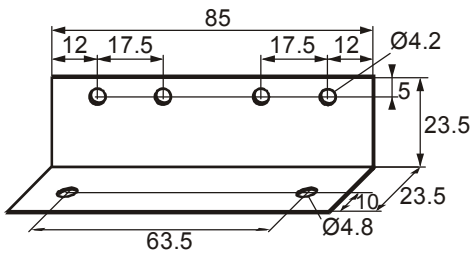

Angle bracket (H140-046.001)
for two PS3
PCN: 803 772

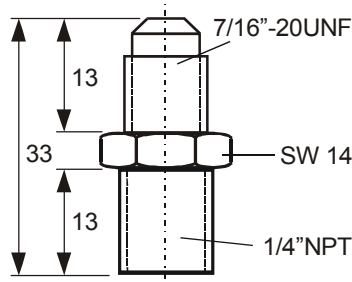

Adapter 1/4" NPT-male -7/16"-20UNF-
male (for compressor direct mounting)
PCN: 800 315

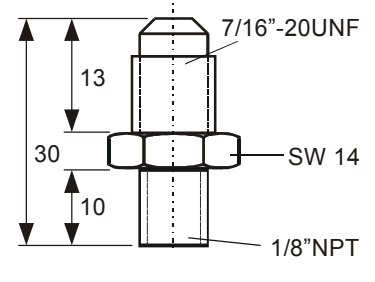

Adapter 1/8" NPT-male-7/16"-20UNF-
male (for compressor direct mounting)
PCN: 800 316

Dimensions

Dimensions Range 1...5, A...E, J...N, S...W (in mm)

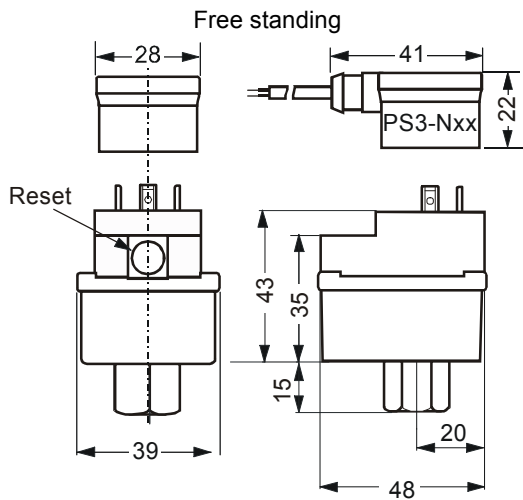

Pressure Connection S
7/16-20 UNF female, with Schrader valve opener

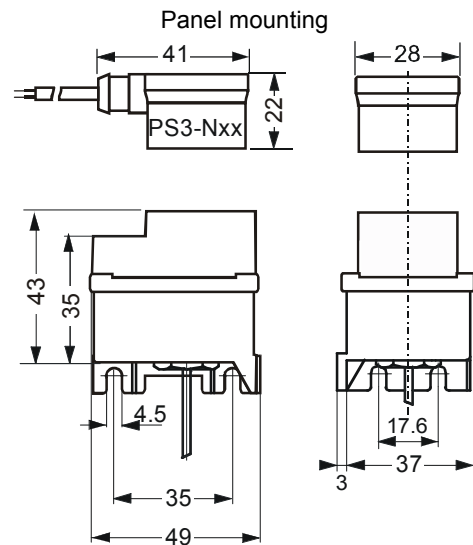

Pressure Connection K
1 m cap tube with flare nut 7/16-20 UNF

Other Pressure Connections Range 1...5, A...E, J...N, S...W

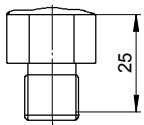

A (Range 1-5)
7/16"-20 UNFmale

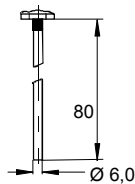

U
80 mm solder connection Ø 6 mm

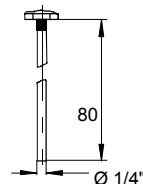

X
80 mm solder connection Ø 1/4"

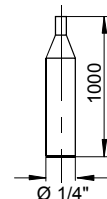

L
1 m cap tube Ø 1/4" solder
conn.

Dimensions Range 6, F, O, X (in mm)

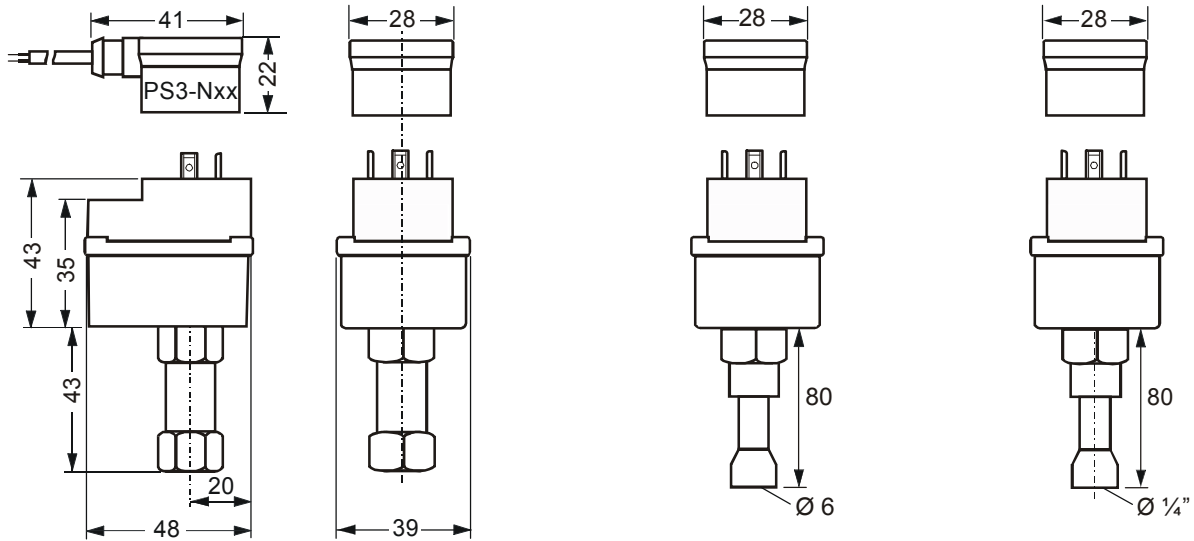

Connection S
7/16-20 UNF female
with Schrader valve opener

Connection U
80mm solder connection
Ø 6mm

Connection X
80mm solder connection
Ø 1/4"

EMERSON is not to be held responsible for erroneous literature regarding capacities, dimensions, applications, etc. stated herein. Products, specifications and data in this literature are subject to change without notice. The information given herein is based on technical data and tests which EMERSON believes to be reliable and which are in compliance with technical knowledge of today. It is intended only for

use by persons having the appropriate technical knowledge and skills, at their own discretion and risk. Our products are designed and adapted for fixed locations. For mobile applications failures may occur. The suitability for this has to be assured from the plant manufacturer which may include making appropriate tests.

This document replaces all earlier versions.

Emerson Electric GmbH & Co OHG ALCO CONTROLS Postfach 1251 Heerstraße 111 D-71332 Waiblingen Germany Phone ...49-7151-509-0 Fax ...49-7151-509-200 www.emersonclimate.eu	Benelux	Phone: +31 (0)77 324 0 234	Fax: +31 (0)77 324 0 235
	Germany, Austria & Switzerland	+49 (0)6109 6059 -0	+49 (0)6109 6059 40
	France, Greece, Maghreb	+33 (0)4 78 66 85 70	+33 (0)4 78 66 85 71
	Italia	+39 02 961 781	+39 02 961 788 888
	Spain & Portugal	+34 93 41 23 752	+34 93 41 24 2
	UK & Ireland	+44 (0) 1635 876 161	+44 (0) 1635 877 111
	Sweden, Denmark, Norway & Finland	+49 (0)2408 929 0	+49 (0)2408 929 528
	Eastern Europe & Turkey	+49 (0)2408 929 0	+49 (0)2408 929 525
	Poland	+48 (0)22 458 9205	+48 (0)22 458 9255
	Russia & Cis	+7 495 981 9811	+7 495 981 9816
Balkan	+385 (0) 1560 38 75	+385 (0) 1 560 3879	
Romania	+40 364 73 11 72	+40 364 73 12 98	
Ukraine	+38 44 4 92 99 24	+38 44 4 92 99 28	