

Technical Information
KOUTURIGISHI-1078H

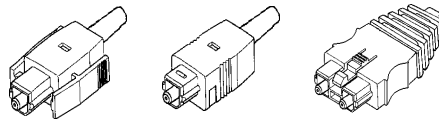

Optical Connector Termination Tool
CAK-0057-EX
Instruction Manual



2011-03-16





- ★The information contained herein is presented only as a guide for the applications of our products. No responsibility is assumed by SUMITOMO ELECTRIC for any infringements of patents or other rights of the third parties which may result from its use. No license is granted by implication or otherwise under any patent or patent rights of SUMITOMO ELECTRIC or others
- ★The information contained here may be changed without prior notice. It is therefore advisable to contact SUMITOMO ELECTRIC before proceeding with the design of equipment incorporating this product.

CONTENTS

	Page
1. Outline	3
1.1 Scope	3
1.2 Features	3
2. Composition of CAK-0057-EX	4
2.1 Composition diagram of CAK-0057-EX	4
2.2 Component parts of CAK-0057-EX	4
3. Component parts of optical connector	5
3.1 Parts list of optical connector	5
3.2 Conceptual diagram for assembly of optical connector	6
4. How to use a microscope	7
4.1 Inspection of a cut face of optical fiber	7
4.2 Batteries exchange	7
5. Assembling procedure for H-PCF cables / cords	8
5.1 Preparatory work for optical fiber cable	8
5.2 Preparatory work for the optical fiber cord	9
5.3 Preparatory works for the ferrule attaching process	9
5.4 Attaching the ferrule	13
5.5 Cleaving the optical fiber	15
5.6 Inspection of the end surface of the cleaved optical fiber	16
5.7 Assembly of the optical connector CF-2071	18
5.8 Assembly of the optical connector CF-1071,CF-1571	21
6. Cable end installation	22
7. Ordering information	23
8. Trouble shooting	24

	Caution	Be careful not to be stuck with tip of optical fiber in eyes, fingers or other parts of a body. It may cause lose sight or other serious injuries.
---	----------------	---

	Caution	Handle the tools and connector component parts with care not to get injured or damage them.
---	----------------	---

	Caution	Don't put fingers or other parts of a body between the blades of ferrule assembly tool JRFK-57 in use. It may cause injury.
---	----------------	---

	Attention	Use tools according to this instruction manual. Wrong usages may cause injury , damage of the tool or sub-standard assembled connector.
---	------------------	--

	Attention	Tool kit CAK-0057 is designed only for our applicable connectors described on the page 3. Don't use for any other products. It may damage the tool.
---	------------------	--

	Attention	For the quality assurance of the applied fiber optic data-link systems, please make sure to perform the optical loss tests after assembling connectors.
---	------------------	---

1. Outline

1.1 Scope





Optical Connector Termination Tool CAK-0057-EX is a termination tool used for the field assembly of Crimp&Cleave optical connector CF-1071, CF-1571, CF-2071 for 200/230 micron SUMIGUIDE™ H-PCF (Hard Plastic Clad Silica Optical Fiber).

Note (1) For the quality assurance of the applied fiber optic data-link systems, please make sure to perform the optical loss tests.

Note (2) This instruction manual provides no explanation or guideline for the use of the optical termination tool CAK-0057 with optical fibers other than 200/230 micron SUMIGUIDE™ H-PCF nor with optical connectors other than CF-1071, CF-1571, CF-2071.

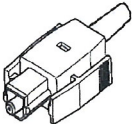
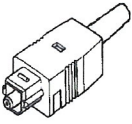
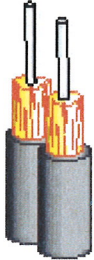
1.2 Features

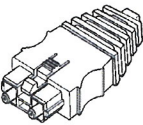
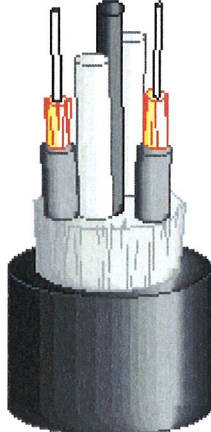
- (1) Provides easy connection of the optical connectors in a short time without using epoxy-cure and polishing processes.
- (2) Modified ferrule assembly tool and optical fiber cleaver enable easy and reliable connection.
- (3) Compact carrying case

Typical applicable fiber optic data-link <small>(Note3)</small>	Connector view	Typical applicable cords/cables	
SUMILINK™ DF-1700/T DF-1700/R DF-1800/T DF-1800/R	 <p>CF-1071</p>  <p>CF-1571</p>	2 Fiber cord DCV-HC-20/07 	2 Fiber cord DCV-HG-20/06 
SUMILINK™ DF-2310 DF-2700 DF-2701 DF-2800 DF-2900	 <p>CF-2071</p>	2-C-V 2 × CCV-HC-20/07 	2-C-VF 2 × CCV-HC-20/07 

Note (3) The type of modules/systems and cables listed herein are the typical of them. For other type of modules/systems and H-PCF cables, please refer to our catalog and technical information.

Note (4) SUMILINK™ is trademarks of SUMITOMO ELECTRIC INDUSTRIES, LTD.

2. Composition of CAK-0057-EX

2.1 Composition diagram of CAK-0057-EX















2.2 Component parts of CAK-0057-EX

No.	Product name of component	Sub code	Quantity
1	Optical fiber cleaver	FOCUS200-EX	1
2	Ferrule assembly tool	JRFK-57	1
3	Microscope	CAT-0057B	1
4	Cap remover	CR-CF2071	1
5	Scissors	-	1
6	Carrying case	-	1
7	Instruction manuals (English)	KOUTURIGISHI-1078	1

3. Component parts of optical connector CF-1071,CF-1571,CF-2071

3.1 Parts list of optical connector

No.	Product name	Item	CF-1071	CF-1571	CF-2071
1	Ferrule	Figure			
		Code	FL-CF1071		
		Quantity	1		2
2	Collar	Figure			
		Code	Collar 4511		
		Quantity	1		2
3	Cord Bush	Figure			
		Code	VJA7084		CB-CF2071
		Quantity	1		1
4	Coil Spring	Figure			
		Code	VJM7069		SP-CF1071
		Quantity	1		2
5	Plug Cap	Figure			
		Code	VJA7218		CP-CF2071
		Quantity	1		1
6	Plug Case	Figure			
		Code	VJA7219-S1	VJA7217-S1	CS-CF2071
		Quantity	1	1	1
7	Dust Cap	Figure			
		Code	VJA7115		DC-CF2071
		Quantity	1		1

Note (1) The quantity is the requirement for a piece of the fiber optic connector.

3.2 Conceptual diagram for assembly of optical connector

(1) CF-1071

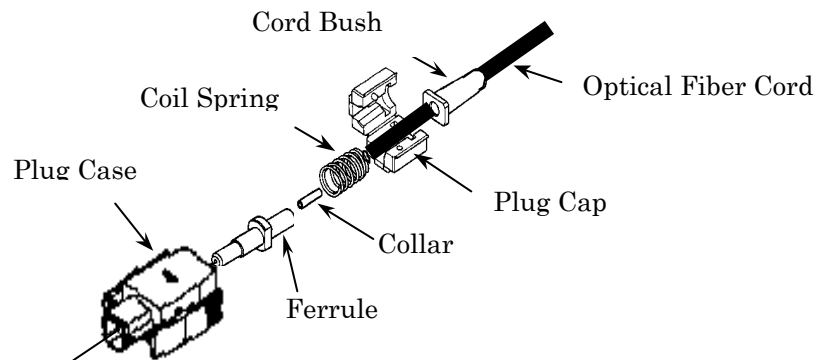

(2) CF-1571

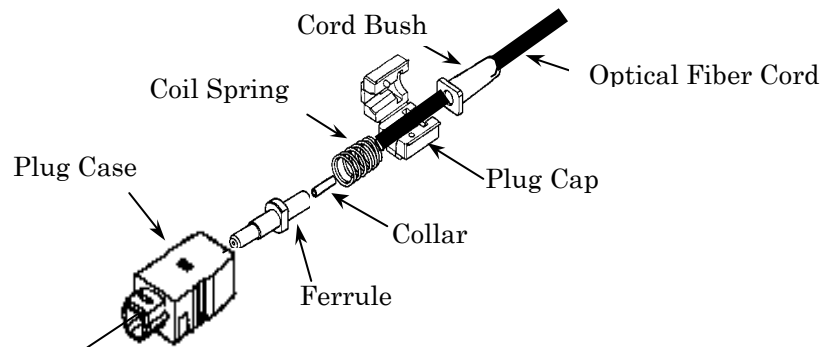

(3) CF-2071

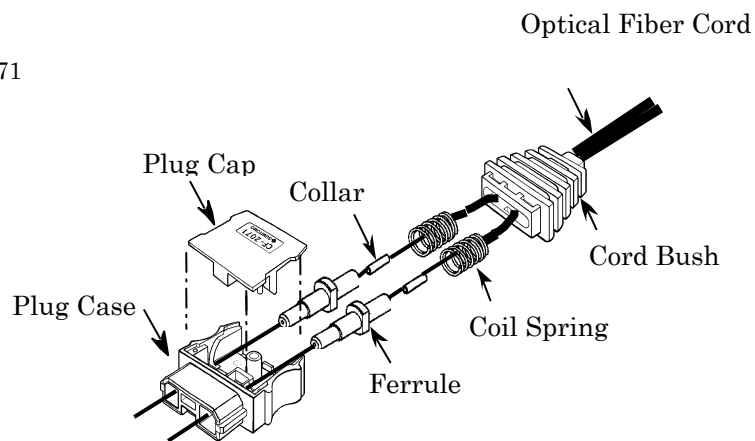

4. How to use a microscope

4.1 Inspection of a cut face of optical fiber

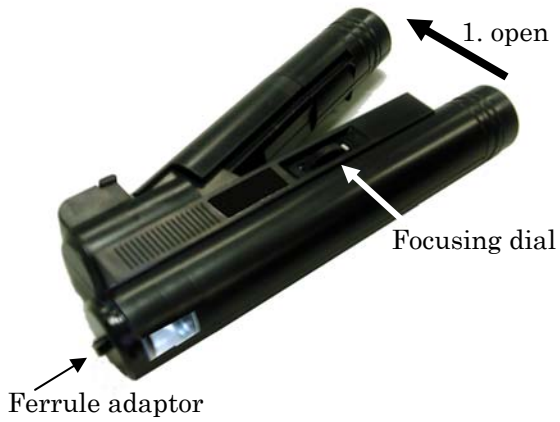

Open the arms, then a lamp inside turns on.

Insert the ferrule into the hole of the ferrule adaptor, and then the face of the cut fiber and the ferrule can be seen by adjusting focusing dial.

Attention: When the microscope is not in use, close its arms to prevent batteries from exhausted.

4.2 Batteries replacement

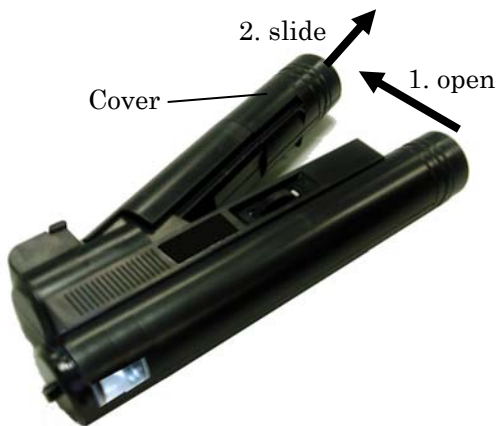

Open the arms and slide the cover in the direction shown by "OPEN", then there appears the battery container.

Attention: When the microscope is not in use, close its arms to prevent batteries from exhausted.

5. Assembling procedure for H-PCF cables/cords.

5.1 Preparatory work for optical fiber cables

(The work shown in this page is mentioned only for cables. In case of cords, please skip it and start from the next page.)

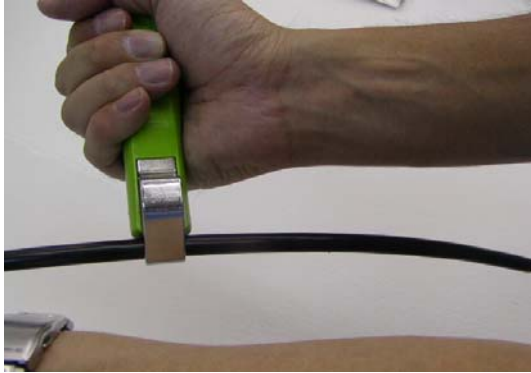

Fig.3

- (1) Remove the sheath by using your own knife. (Fig.3)
Remove length ----- 200mm (Reference value)



Fig.4

- (2) Cut off the hold tape, the filler and the filler cords at the end of the sheath with the scissors to expose the optical fiber cords and the central strength member . (Fig. 4 to 5)

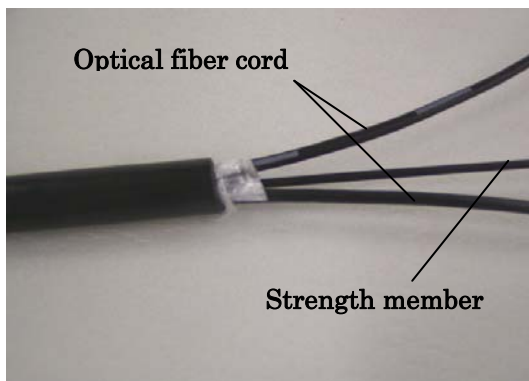

Fig.5

- (3) Insert the optical fiber cords and the tension member into the protective boot and cover the end of the sheath with the protective boot. (Fig. 6)

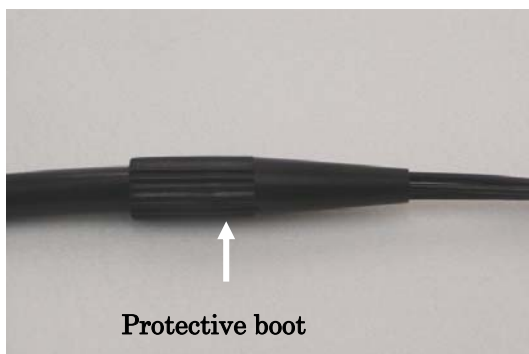

Fig.6

5.2 Preparatory work for the optical fiber cord.

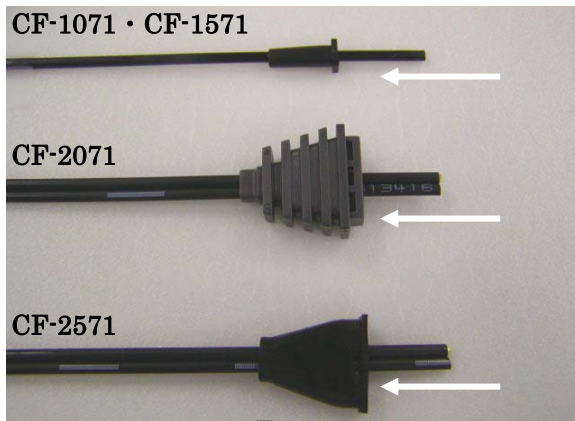

Fig.7

(1) Insert the optical fiber cord from the bottom(smaller) mouth of the cord bush. (Fig.7)

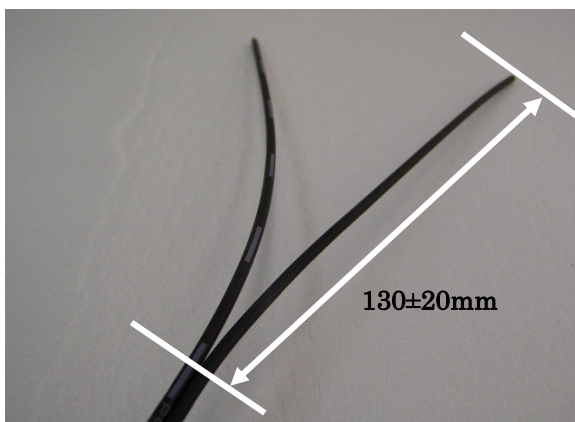

Fig.8

(2) Insert the gap at the end of the connection part of the optical fiber cord, and then by tearing the optical fiber cord, separate it into simple cord each. (Only for the duplex cord.) Separation length ----- 130 ± 20 mm (Fig.8)

5.3. Preparatory work for the ferrule attaching process



Fig.9

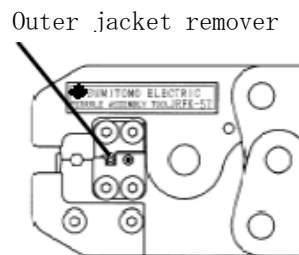

Fig.10

(1) Insert the cord into the outer jacket remover of the ferrule assembly tool from its front face (label face) , and then grasp the handle and pull the cord back straight. In this way, the outer jacket (black) of the optical fiber is removed. (Fig.9,10)

Remove length ----- 35 mm



Fig.12

Note : For remove length please refer to the label that has 35mm width. (Fig. 12)

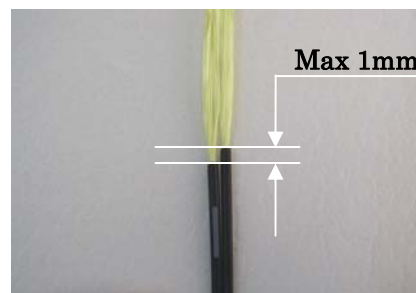

(Fig. 11)

Note: The difference in jacket lengths should be no more than 1mm. (Fig.11) Otherwise the optical fiber may bend when the connector is assembled.

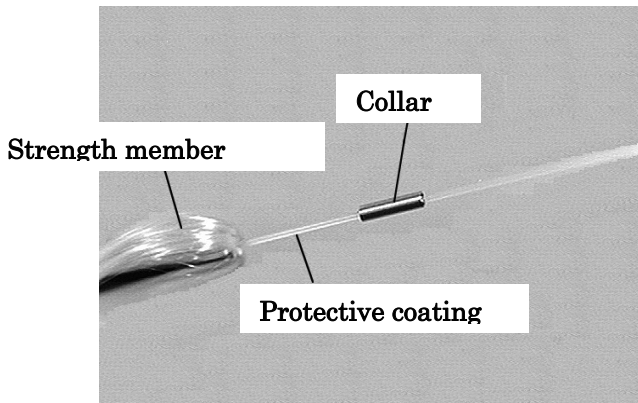

(Fig. 13)

- (2) Fold back the strength member yarn at about two strands and then insert the optical fiber into the collar . (Fig. 13)

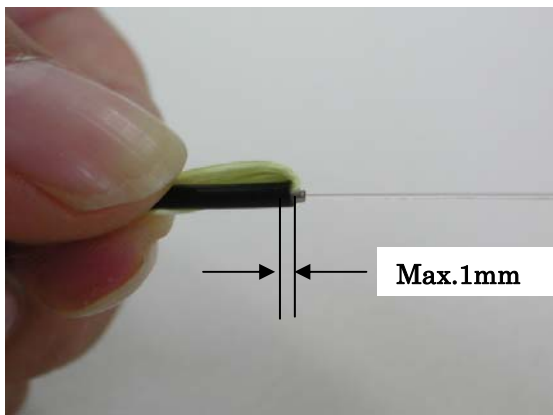

(Fig. 14)

- (3) Insert the collar into the cord jacket.

Note: Please make the collar projected from the cord jacket by no more than 1mm. (Fig.14)

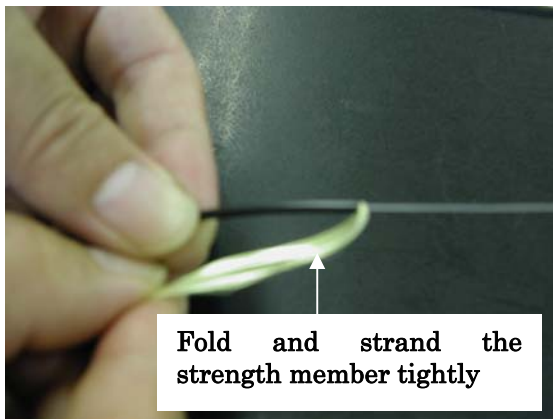

(Fig. 15)

- (4) Keep the strength member folded and strand it tightly. (Fig.15)

- (5) Put the optical fiber in protective coating remover through guide hole from front face (label face). (Fig.16 ,17)

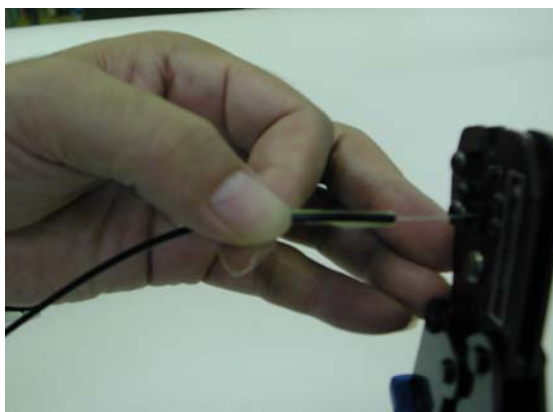

(Fig. 16)

Protective coating remover
(guide hole)

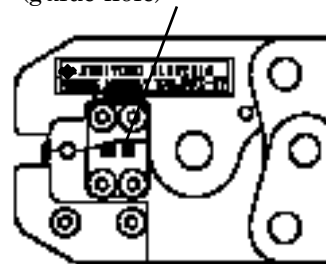

(Fig. 17)

Note: Be careful not to nip the strength member between the blade of the remover, or the blades will be damaged.



(Fig.18)

(6) Grasp the handle and pull the fiber back straight. (Fig.18)

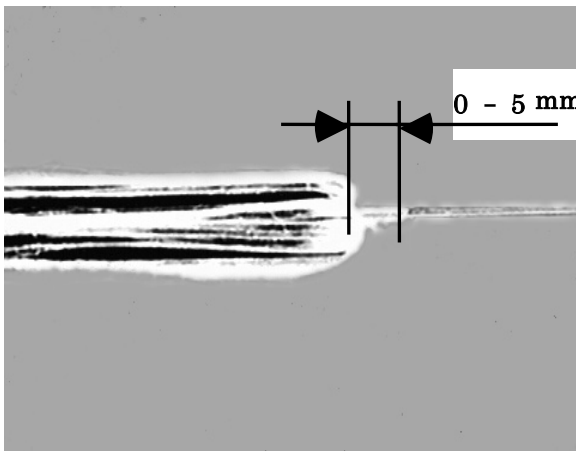

(Fig.19)

Note: The remaining length of the protective coating should be less than 5mm. (Fig.19)

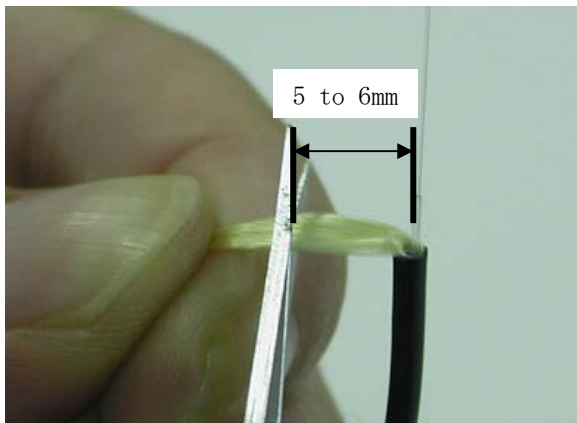

(Fig.20)

(7) Adjust the length of the strength member to 5 to 6mm with scissors. (Fig.20)



(Fig.21)

Note: Make sure to leave the strength member 5 to 6mm. This is necessary to get the pullout strength between the optical fiber cord and the ferrule. (Fig.21)

Caution

When the blades of the protect coating remover are broken or the procedure is out of accord with this manual, during the stripping of the protective coating, it may happen that the plastic cladding of the optical fiber is damaged (surface of the cladding is whitened or becomes glittering). In this case, the optical fiber may be broken at the point of the damage in the succeeding assembling process or in the connector under use, because the cladding of H-PCF is a vital part to insure its high-strength and high-reliability by protecting the silica core. So please do not forget to perform the following **proof test** before proceeding the next step in order to make sure that there are no damage on cladding whether the the surface of the cladding is whitened or not.

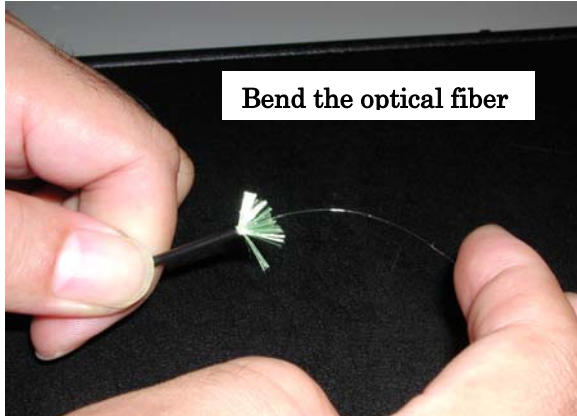

(Fig.22)

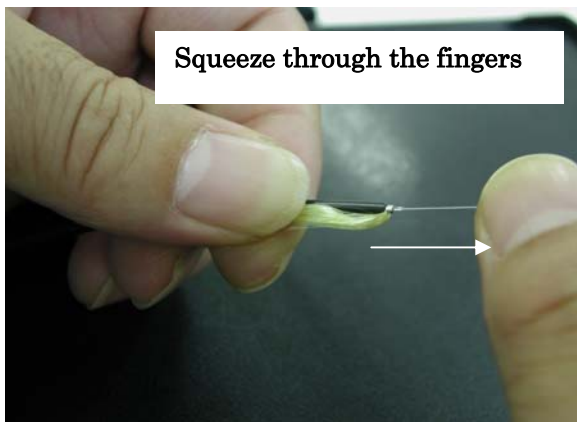

(Fig.23)



(Fig.24)

(Important)

- (8) Hold the optical fiber cord (black, 2.2mm dia.) by a hand and tip the bare optical fiber (core & cladding) 3 to 4 times gently with a finger of another hand so that the fiber bend ± 120 degrees. And squeeze the surface of the whole length of the bare optical fiber about ten times from the protective coating end to the fiber end.

If the cladding is damaged, the fiber is broken down through these screening processes. (Fig.22 to 23) Finally observe the bare optical fiber against a black background so that the damage of the cladding can be seen white like. (Fig.24)

Note: Be careful not to damage the cladding by scratching the fiber surface with nails.

Note: Eye glasses or Protecting goggle is recommended to save your eyes from particles of the broken fiber.

Note: Particles of the broken fiber should be collected by adhesive tape or other method to avoid that they harm human bodies.

5.4 Attaching the ferrule

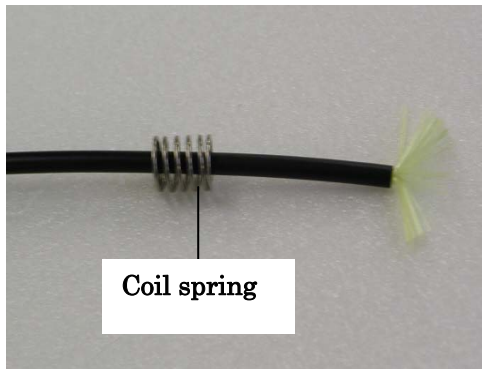

(Fig.25)

- (1) Fix the coil spring onto the optical fiber cord. (Fig.25)

Note: When assembling duplex type connectors, perform the operations from this step to "5.5 cleaving of the optical fiber" separately for each core of the optical fiber.



(Fig.26)

- (2) Insert the optical fiber into the ferrule. (Fig.27)

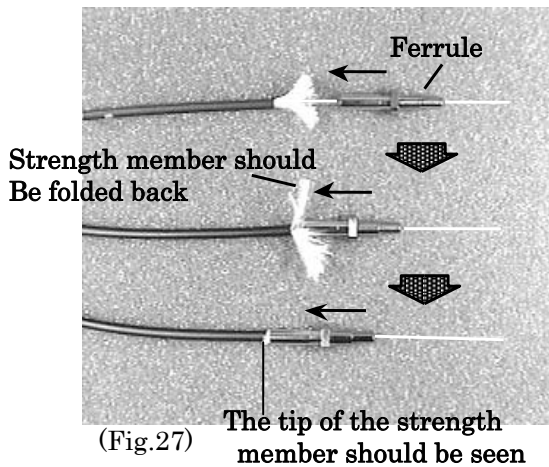

(Fig.27)

Note: Make sure to insert the optical fiber cord into the ferrule exactly until the folded strength member projects no more than 2mm from the bottom of the ferrule. (Fig.27)

- (3) Set the flange of the ferrule inserted the optical fiber on press-in blade. Note the set direction. (Fiber cord should be to ferrule guide.) (Fig.28 ,29)

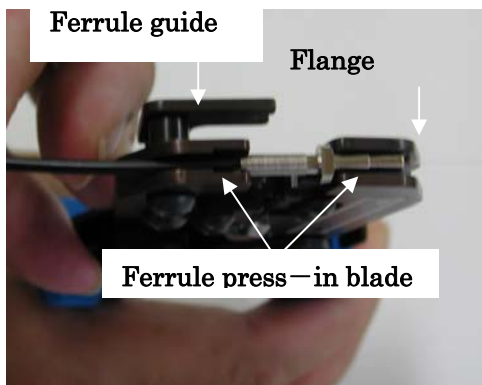

(Fig.28)

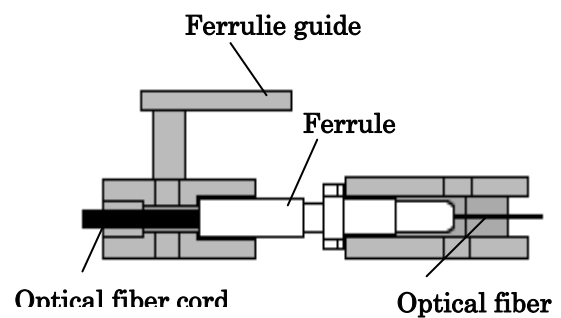

(Fig.29)



(Fig.30)

- (4) Grasp the handle till it goes no more touching on the limit screw. (Fig.30,31)
This makes the ferrule pressed axially and shortened, and the optical fiber is held inside.

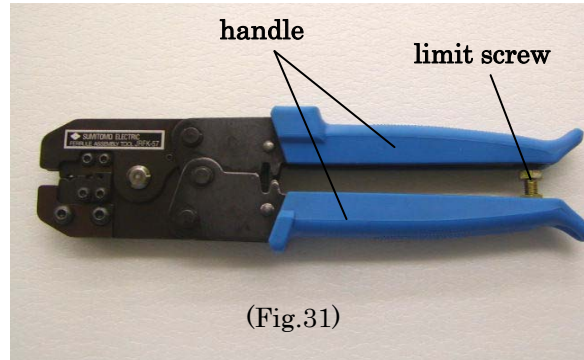

(Fig.31)

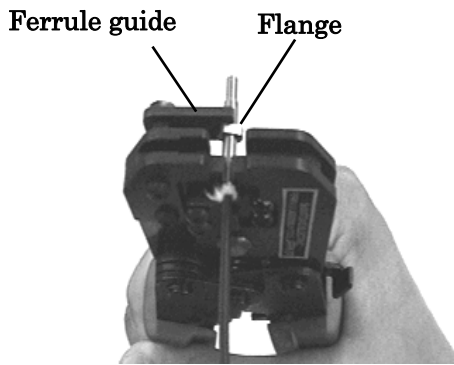

(Fig.32)

- (5) Set the ferrule onto ferrule guide putting the flange of the ferrule on the ferrule guide from inside. (Fig.32,33)

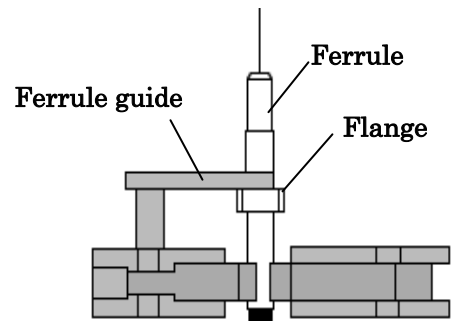

(Fig.33)

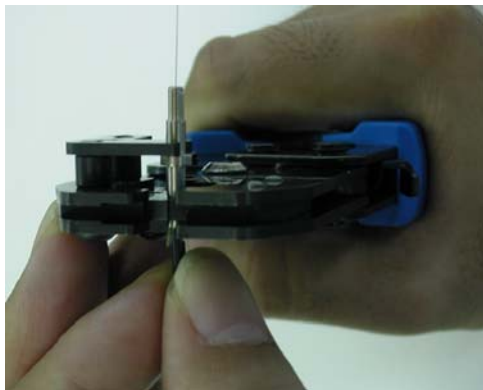

(Fig.34)

- (6) Grasp the handle till it goes no more touching on the limit screw, with pushing the optical fiber cord slightly toward the ferrule in order not to get out the cord from the ferrule. (Fig.34,35)
This makes the outer jacket of the cord and the strength member grasped between the collar and the ferrule.

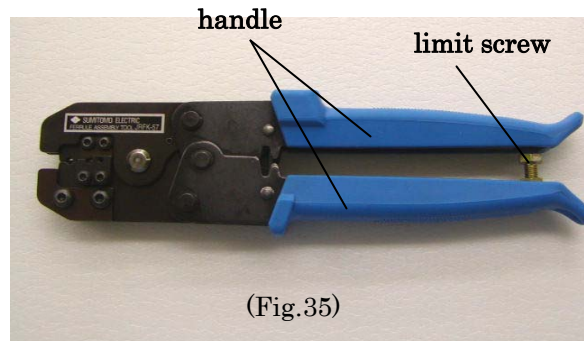

(Fig.35)

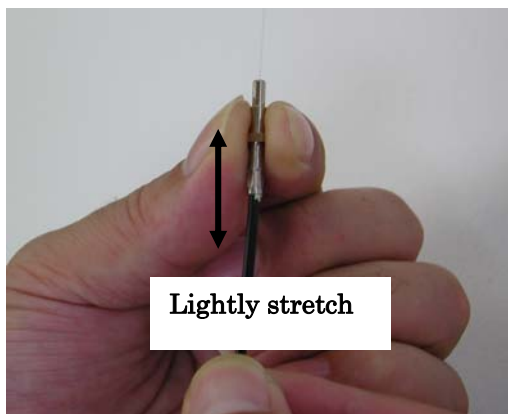

(Fig.36)

- (7) Lightly stretch the ferrule from the optical fiber cord by hands to confirm that the optical fiber cord is tightly fixed onto the ferrule. (Fig.36)

5.5 Cut the fibers (at the face of the ferrules)

Please see the instruction manual for respective connector and the tool kit except for the procedure shown bellow.

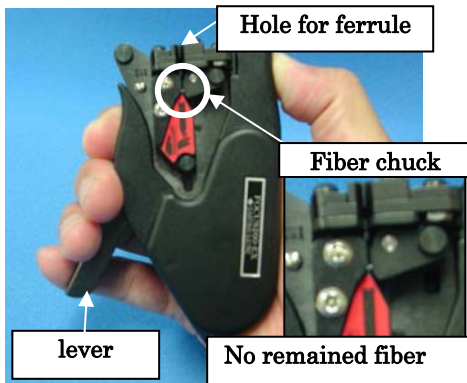

- (1) Hold the cleaver with your right hand as shown in the left photo.
- (2) Make sure that there are no fiber chips or other waste remained on fiber chuck.

! Attention

Don't hold the cleaver covering fiber chuck with the hand as shown in the right photo. Fiber chip at the fiber chuck may hurt the hand.

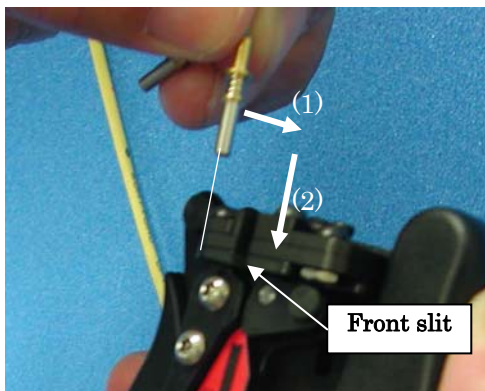

- (3) Let the optical fiber coming out of the ferrule through the front slit, then insert the ferrule into the hole for ferrule. Then make sure that the ferrule is put in deep enough for the front face of it to be on the blade.

! Attention

Note : Don't let the optical fiber through the hole for ferrule. It may break the fiber.

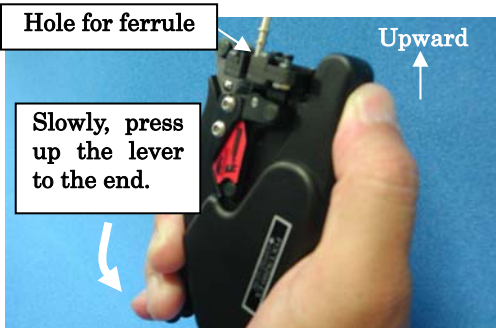

- (4) Direct the hole for ferrule upward, and slowly, press up the lever to the end, then the optical fiber will be cut properly.

* Don't touch the ferrule when pressing the lever. It can cause poor cleave quality.

* Don't press up the lever fast. It can cause poor cleave quality.

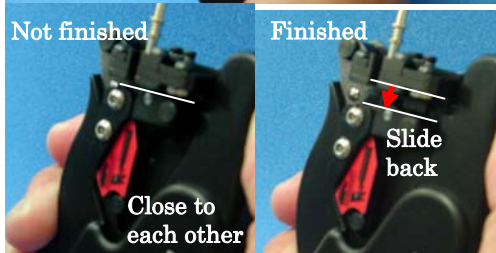

* The lever should be pressed up to the end. When the optical fiber is cut, the fiber chuck is slide back.

* Hole for ferrule should face upward when pressing the lever. Otherwise, the optical fiber may be cut at a little out of the face of ferrule.

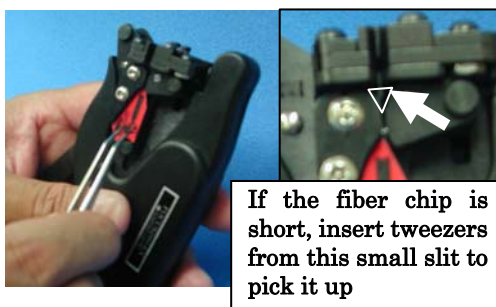

- (5) Release the lever, and take out the chip of optical fiber from fiber chuck with tweezers.

! Attention

Chips or particles of optical fibers can hurt human body. Be careful not to be stuck.

(Important)

5.6 Inspection of the end surface of the cleaved optical fiber.

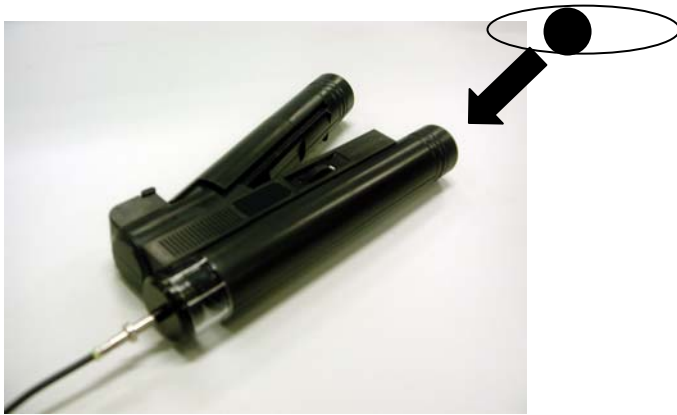

(Fig.42)

Inspect the finished end surface of the optical fiber with using the microscope CAT-0057B. (Fig.42)

(Pleas see page 7 for detail.)

- * Make sure to perform also the optical power test by using the optical power tester.
- * Inspect the face with revolving the ferrule.
- * Inspect the face with lighting the another end of the optical fiber.
- * The faces of the optical fibers, together with those of the ferrules, will be seen with a microscope. compare them with examples shown next page. If they correspond to any of sub-standard samples, retry from the first stop.

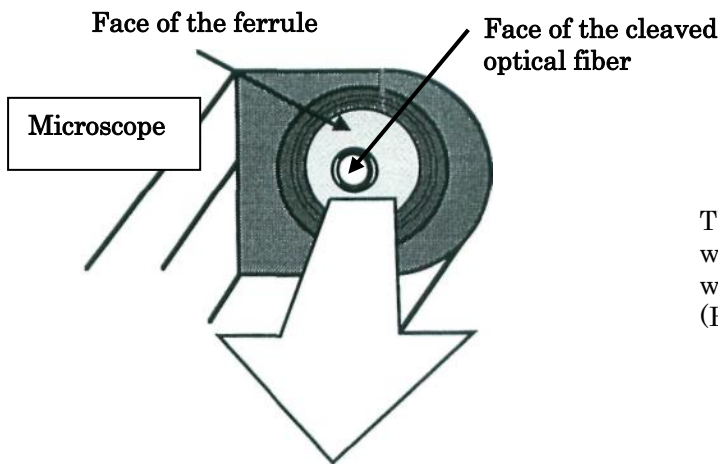

(Fig.43)

The faces of the optical fibers, together with those of the ferrules, will be seen with a microscope.

(Fig.43)

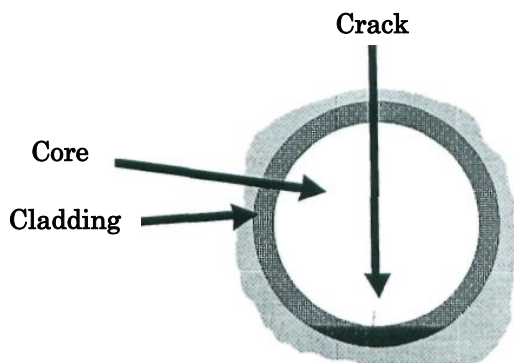

(Fig.44)

(Satisfactory sample)

The face if the core is smooth and the length of the crack is less than 1/10 of the core diameter.

(Fig.44)

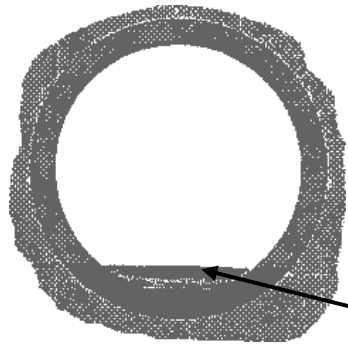

(Sub-standard sample)

The length of cutting flaw is more than 1/8 of the core diameter.
(Fig.45)

Cutting flaw

(Fig.45)

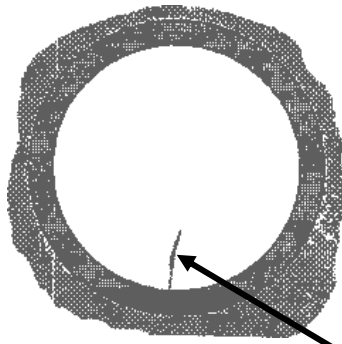

(Sub-standard sample)

The length of the crack is more than 1/10 of the core diameter.
(Fig.46)

Crack

(Fig.46)

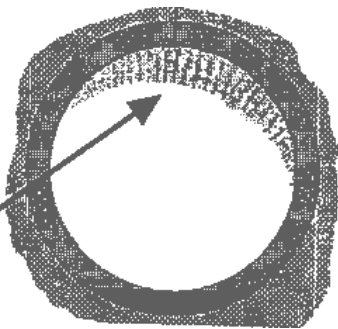

(Sub-standard sample)

Hackle is observed on the face.
(Fig.47)

Hackle

(Fig.47)

Dark image

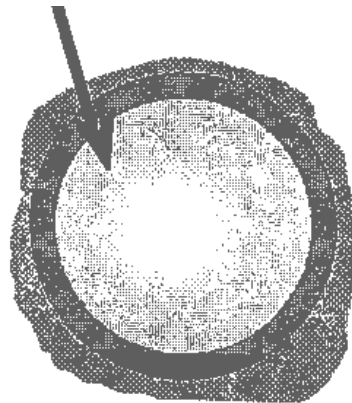

(Sub-standard sample)

Cutting face isn't right angled to the axis of the fiber.
(Fig.48)

(Fig.48)

NOTE: When the quality of the faces of optical fiber get poor frequently, please move the blade to shift the cutting portion reference in page 25.

5.7 Assembly of the optical connector CF-2071

(See 5.8 for CF-1071 and CF-1571)

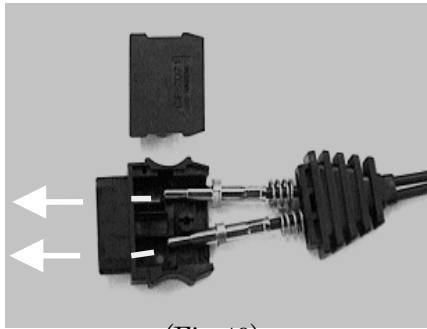

(Fig.49)

- (1) Insert the both ferrules into holes on the plug case from inside, and fix the cord bush onto the groove on the plug case. (Fig.49)

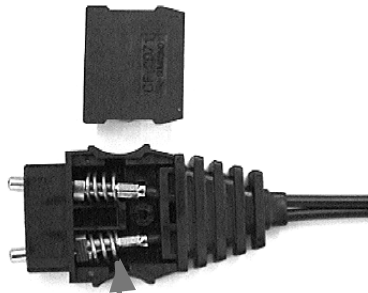

Make sure that the each coil spring doesn't get on the rim of the hollow.

(Fig.50)

- (2) Put the coil springs within the hollow inside the plug case. (Fig.50)

Make sure that the each coil spring doesn't get on the rim of the hollow.

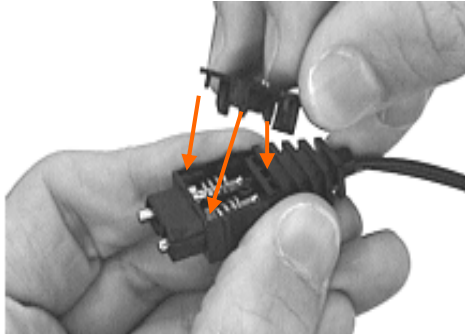

(Fig.51)

- (3) Put the plug cap into the plug case taking care that the ferrules, the coil springs and the cord bush don't get out of their places. (See below and Fig.51,52)

·This procedure will be easier when the plug case is held slightly inclined as shown in Fig.51,52.

·Plug cap should be pushed in being kept parallel to the plug case.(Fig.52)

·The spring stopper on the plug cap should go along the taper part of the guide groove inside the plug case, so that the stopper will hold the end of the coil spring correctly.(Fig.52)

·The cord bush stopper on the plug cap should go into the hole on the cord bush.(Fig.52)

·A center guide pin and two side guide pins on the plug cap should go into respective holes on the plug case.(Fig.52)

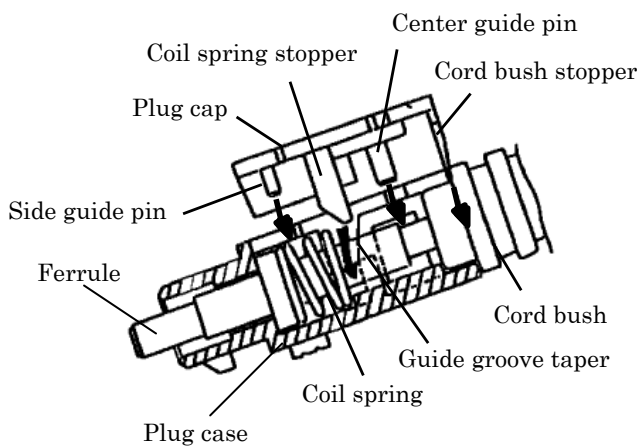

(Fig.52)

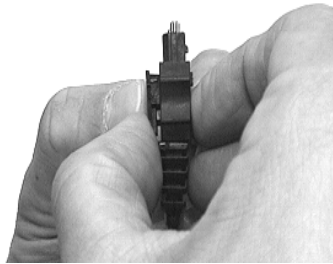

(Fig.53)

(4) Push in the plug cap completely. (Fig.53)

Attention:

-Don't push on a latch arm especially a lock release button. Stresses given on the latch arm may break it and cause latch lock failure. (Fig.54)

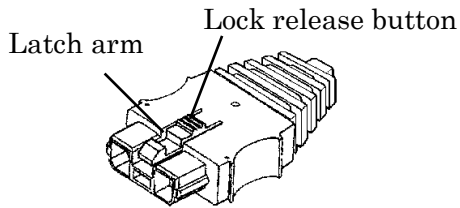

(Fig.54)

Attention:

-Incorrect placement of coil springs or ferrules may cause interference against the plug cap. When the plug cap isn't put in completely, remove the plug cap and retry with new plug case and plug cap. (They may be damaged with put-in and remove procedure.)

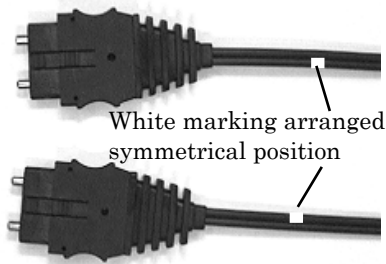

(Fig.55)

Attention:

-Set the ferrules so that the white mark on the optical fiber cord connected to one connector may be symmetrical to that on the optical fiber cord connected to another. (Fig.55)

(Pay attention to the positions of the light-emission and light reception sides of the two optical connectors.)

When pull the cord, the ferrules are also moved back .

When release, ferrules return to the original position.

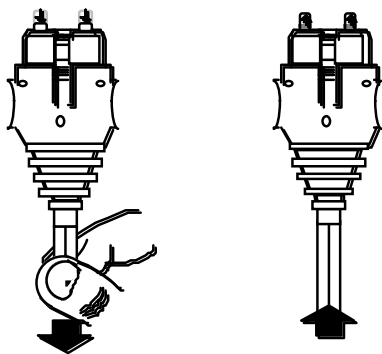

(Fig.56)

(5) To examine the connector assembled correctly , pull the optical fiber cord lightly (<20N) on and off holding the plug case , and see if the ferrules move to it. (Fig.56) If not, there may be something wrong inside.

Please disassemble and check up.

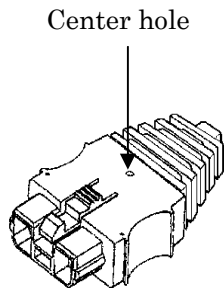

(Fig.57)



(Fig.58)

- (6) The plug cap put in the plug case may be removed by pushing out the center guide pin on the plug cap through the center hole of the plug case (Fig.57) by the cap remover. Put the cap remover on an appropriate table setting its center pin to the center hole on the plug case, and then hold the sides of plug case by both hands and push it down strongly (Fig.58).

Attention:

- Once a plug cap is removed, the plug cap and the plug case should be replaced with new ones.(They may be damaged with put-in and remove procedure.)
- Remove operations should be done with care to prevent human body from getting hurt. Especially, if it is done with holding the cap remover by your hand, you may be injured by the unexpected situations, such as the pin slipped out from the cap remover. So this operations must be done with putting the cap remover on an appropriate table.
- Remove operations should be done with care not to damage the optical fibers and coil springs.

5.8 Assembly of the optical connector CF-1071,CF-1571

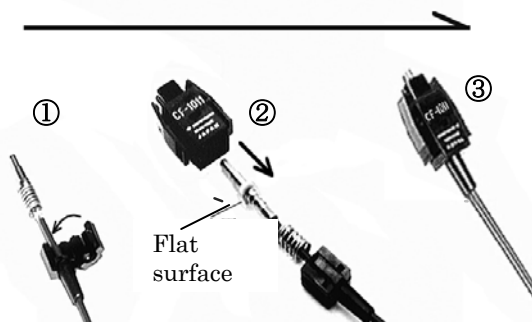

CF-1071(Fig.59)

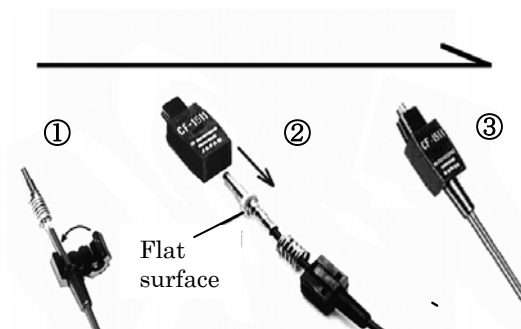

CF-1571(Fig.60)

- (1) Fix the plug cap onto the cord bush.
(shown as ① in Fig.59 and Fig.60)
- (2) Assembly of the plug case.
(shown as ② in Fig.59 and Fig.60)

Note: The flange of the ferrule has two flat surfaces to prevent the ferrule rotation.

When assembling the single fiber type optical connectors (CF-1071&CF-1571), insert the ferrule into the plug case so that the flat surfaces of the ferrule contact both the right and left sides of the ferrule insertion hole of the plug case. If not, the ferrule doesn't go out of the plug case enough and it cause coupling loss increase. (Fig.61)

- (3) To examine the connector assembled correctly, pull the optical fiber cord lightly (<20N) on and off holding the plug case, and see if the ferrules move to it. (Fig.56) If not, there may be something wrong inside. Please disassemble and check up.

Note: Disassembling should be done with care to prevent human body from getting hurt.

Note: Disassembling should be done with care not to damage the optical fibers and coil springs.

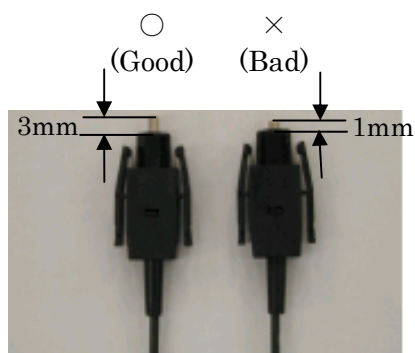

(Fig.61)

Note: Once a plug cap is removed, the plug cap and the plug case should be replaced with new ones.(They may be damaged with put-in and remove procedure.)

6. Cable end installation

- (1) Fix the cable holding back the central tension member so that the optical fiber cords are not stretched.
- (2) Use cable holder or so for the cable not to sway.
(Be careful not to press the cable and fiber cords with the holder.)
- (3) Keep minimum radius bend of both cables and optical fiber cords.

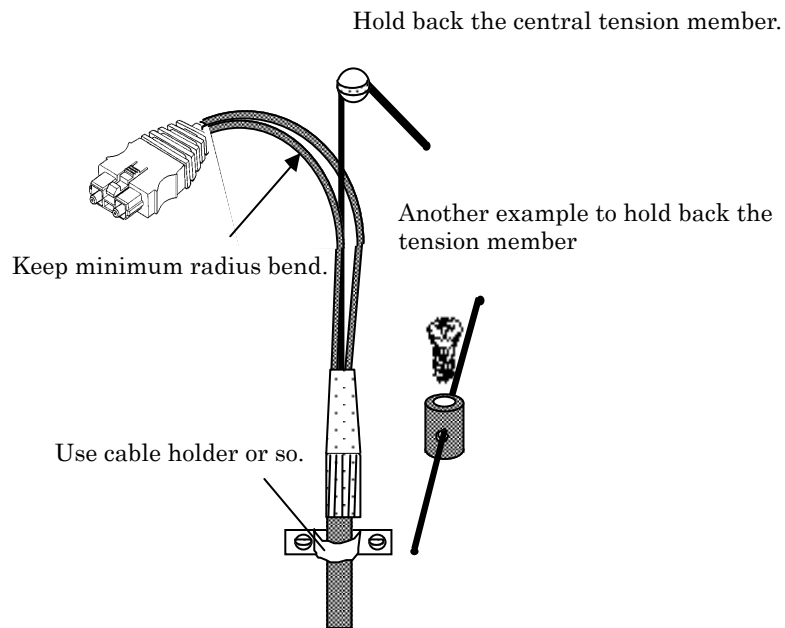

(Fig.62)

7. Ordering information

Please specify product name, product code and number of products required.

7.1 Optical connector termination tool kit

Product name	Product code	Sales unit (set)
Optical Connector Termination Tool Kit	CAK-0057-EX	1
Optical Fiber Cleaver	FOCUS200-EX	
Ferrule Assembly Tool	JRFK-57	

7.2 Optical connector

Product name	Product code	Sales unit (set)
Optical Connector	CF-1071	50
	CF-1571	
	CF-2071	
Ferrule ^(Note)	FL-CF1071Plus	
Protective Sleeve	S-201	
	S-202	
	S-204	

Note: A set of "FL-CF1071Plus" contains a ferrule "FL-CF1071" and a collar "4511"

8. Trouble shooting

	Trouble	Typical causes and treatments	Reference
(1)	It is difficult to insert the collar into the outer jacket properly.	* The strength member is put aside. [Please fold back the strength member at about two strands.]	5.3 (2)
(2)	When stripping off the protective coating (semitransparent), the optical fiber is pulled out from the outer jacket.	* If the length of fiber optic cord is short, please wind the fiber optic cord twice or three times around your fingers when you strip off the protective coating.	5.3 (6)
(3)	After the stripping of the protective coating, the fiber is easily broken by the bending or squeezing test. Or, after stripping the protective coating, white powder-like resin is observed on the surface of the cladding.	* A part of the strength member yarn is crimped by guides or blades of the protective coating remover of the ferrule assembly tool. * The blade of the protective coating remover of the ferrule assembly tool is damaged by the improper crimping of the strength member yarn or silica core. [Be careful not to grip the strength member yarn with blades of the ferrule assembly tool.]	5.3 (6)
(4)	It is difficult to insert the optical fiber cord into the ferrule.	* The strength member is put aside. * The protective coating (semitransparent) is not properly removed from the end of the jacket (black). [Maximum remaining length:5mm] * Separation of the duplex cord into 2 simplex cords is not symmetric	5.4 (2) 5.3 (6) 5.3 (1)
(5)	At the stretching test between ferrule and cord, the cord is pulled out from the ferrule.	* The length of the remained strength member yarn is too short. [Remaining length: 5 to 6 mm] * A collar is not inserted into the jacket. [Please do not forget to insert the collar.] * The ferrule is not on the correct position when it is cramped. * The fiber cord is pulled out from the ferrule when cramping the ferrule. [Please push the cord slightly when cramping the ferrule.]	5.3 (7) 5.3 (2) 5.3 (5) 5.4 (6)
(6)	Fiber isn't cleaved by pulling the trigger or cleaved fiber surface is not good.	* There remain fiber chips or other wastes on fiber chuck of the cleaver. * The ferrule isn't put deeply enough into the hole of the cleaver. * The fiber isn't held properly in the ferrule. [Please check the ferrule press-in procedure.] * The blade of the cleaver is damaged.	5.5 (2) 5.4 (3),(4)
(7)	(Only for single fiber type connectors) Fiber output power is not satisfactory.	* The ferrule may not be set correctly.	5.8 (2)

(8) Maintenance of fiber cleaver FOCU200-EX

In the case the quality of the faces of optical fiber get poor frequently, please move the blade to shift the cutting portion by following procedure.

* The estimated life for cutting at the one portion of blade is about 300 cuttings.

(1) With a hex wrench (size 1.5mm), screw down the two hexagon bolts on the blade positioning plate to allow it move. (Fig.64)

! Attention

* Don't screw down the hexagon bolts more than 5 turns. It can cause the cleaver trouble.

* Don't screw down any other hexagon bolts other than size 1.5mm. It can cause the cleaver trouble.

(2) Hold the blade positioning plate and slide it to the direction of an arrow just one division of scale at a time. (Fig.65)

(3) Screw up the two hexagon bolts on the blade positioning plate, avoiding pushing it sideward. (Fig.66)

! Attention

* Don't push the blade positioning plate sideward. It can cause the cleaver trouble.

(4) Try the operation of cutting fiber in practice. In case that the fiber can't be cut or the fiber is broken before pressing up the lever, once screw down the two hexagon bolts, and then retry the process (3).

< Front panel >

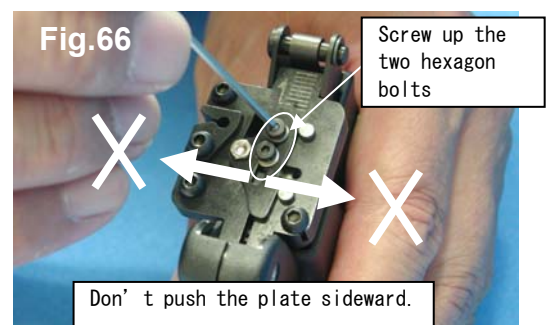
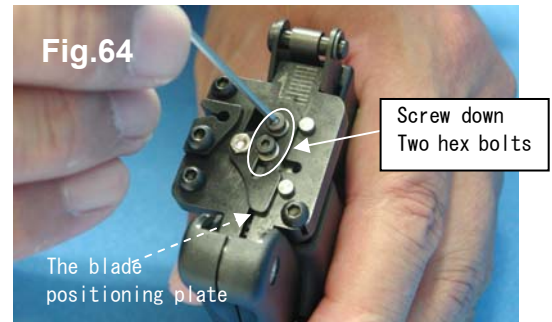
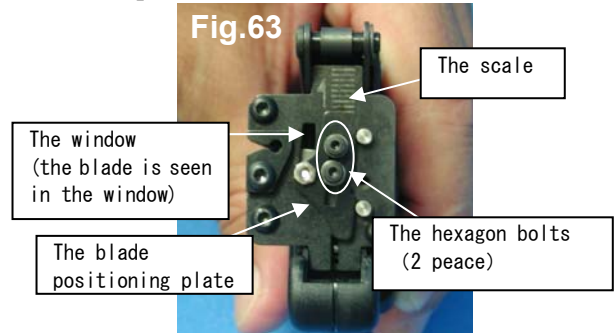

Whole length of the blade will be used up at reaching fifth division of the scale. The blade is exchangeable at the manufacturer works. Please contact the sales agency.

Cleaning the fiber chuck

In the case that fiber is broken repeatedly at the chuck before cutting, it is attributed to the fact that chips or particles of optical fibers are caught in the fiber chuck.

Please clean up the fiber chuck by the following procedure.

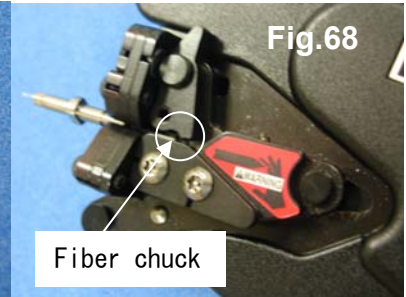
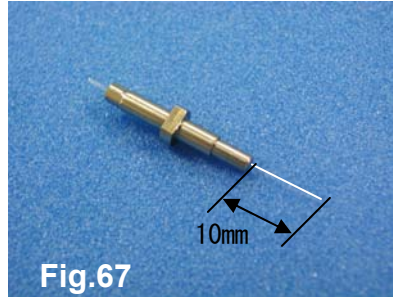

(1) Insert a piece of clean cloth to the gap between fiber chuck. (Fig.69)

- * Don't use the dirty cloth or breakable cloth. There is a possibility of the trouble become worse.
- * Insert the cloth to the bottom. There is a possibility that chips or particles of optical fiber can't be cleaned up. (Fig.70)

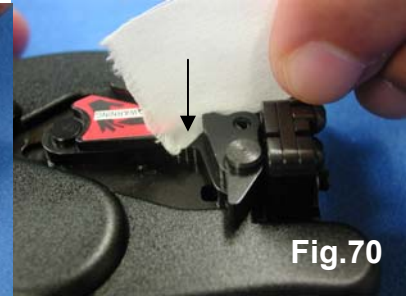

(2) With inserting cloth, press up the lever. It cause that cloth is hold with chuck. (Fig.71)

- * Please look that cloth is held with chuck. (Fig.72)

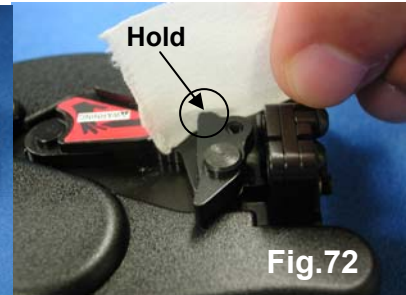

(3) With holding cloth chucked, pull cloth out of chuck obliquely upward. (Fig.73)

! Attention

- * Don't pull cloth in a horizontal direction. There is a possibility that the blade is damaged. (Fig.74)
- * Cloth should be pulled out to the end. It is normal that cloth is caught by cam.
- * In the case that snips of cloth are remained in chuck, insert tweezers to pick it up. (Fig.75)

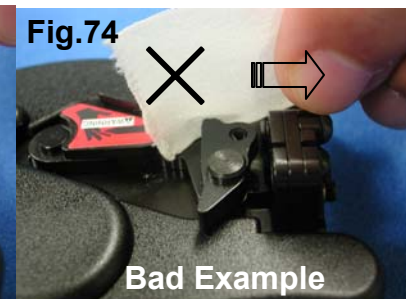
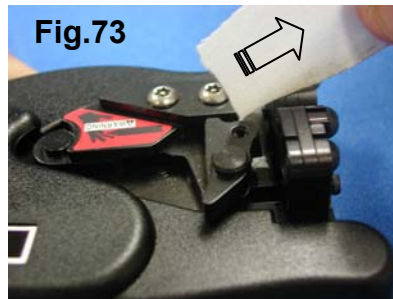

After you clean the fiber chuck, please check the problem is resolved by actually cutting the fiber. In the case that the problem is not resolved despite several cleaning, please contact the sales agency.