

ET ATTUATORI
- PNEUMATIC ACTUATORS AND ACCESSORIES -

INSTALLATION OPERATION & MAINTENANCE MANUAL



ISO 9001:2000- Cert. n° 0210/3

RACK AND PINION PNEUMATIC ACTUATORS



GTX SERIES

II 2GDc110°C Technical File Ref. n° 2003/01

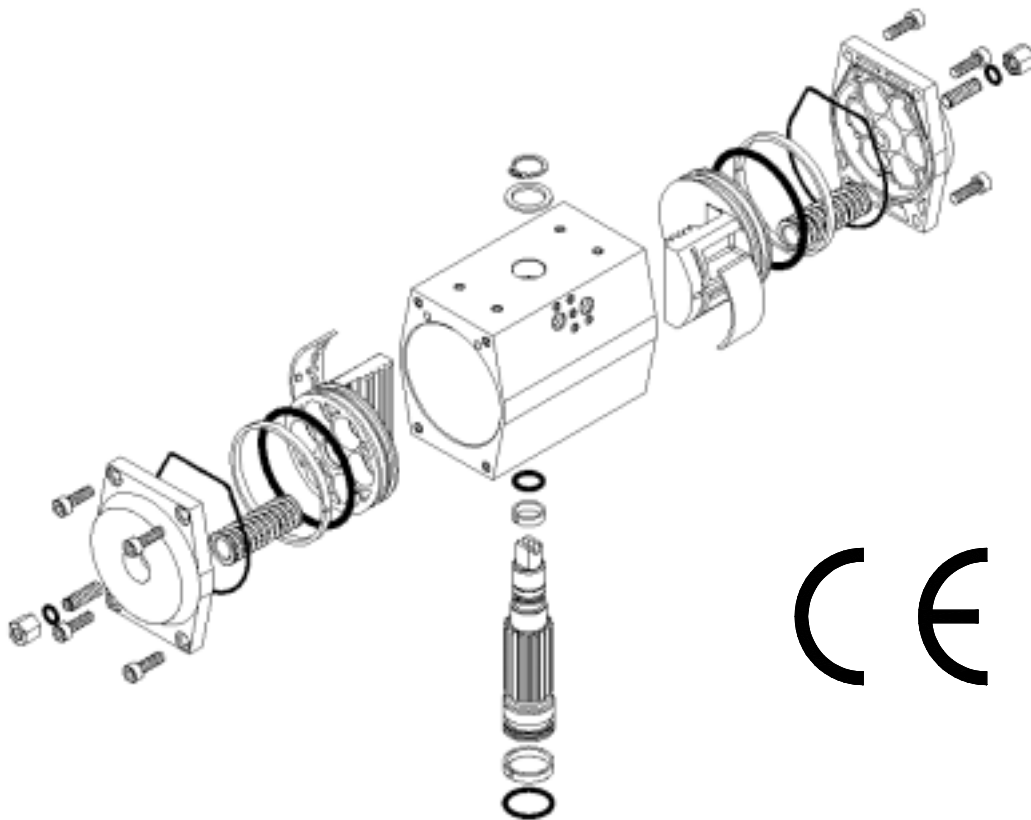

TABLE OF CONTENT

	PAG.
1.0 INTRODUCTION	3
2.0 STORAGE	3
3.0 OPERATIONAL CHARACTERISTICS	3
4.0 ACTUATOR INSTALLATION	4
5.0 DISASSEMBLY PROCEDURE	7
6.0 RE-ASSEMBLY PROCEDURE	8
7.0 SPRING CARTRIDGES INSTALLATION	10
8.0 SOLENOID VALVES CHARACTERISTICS	12
9.0 SOLENOID VALVES INSTALLATION	15
10.0 FCCW TO FCW CONVERSION	16
11.0 ACTUATOR SIZING	17
12.0 DOUBLE ACTING ACTUATORS	17
13.0 SPRING RETURN ACTUATORS	17
14.0 ACTUATORS CICLE TIMES	18
15.0 SAFETY INSTRUCTIONS	19
16.0 DANGEROUS AREAS	19
WARRANTY INFORMATION	20

1.0 INTRODUCTION

G.T. Attuatori offers a largest ranges of pneumatic rack and pinion actuators . Conceived for the installation on valves of control of the fluids, which ball valves, butterfly valves, etc.and have fed with pressed air.

The actuators are built for operate with a maximum pressure of 10 Bar., and tested for an operational least life of 1 million of manoeuvres.

The greasing performed during the assemblage guarantees a correct lubrication of the actuators for at least 500.000 manoeuvres.

GT actuators are designed to operate within the pressure range of 1.4 Bar (20 PSIG) to 10 Bar (142 PSIG) and are offered in two styles:

- DOUBLE ACTING: Available with rotation of 90°, 120° e 180° .
- SPRING RETURN: Available with rotation of 90°.

The double acting and spring return actuators can easily be field converted to the other configuration by insertion or removal of the unique patented G.T. Attuatori spring cartridges.

2.0 STORAGE

All G.T. Attuatori actuators are factory lubricated for life.

The actuator ports are plugged to prevent liquids or other materials from entering the actuator during shipment.

If the actuators are to be stored for a long period of time before installation, the units should be stroked periodically to prevent the seals from setting. (Note: the plugs must be removed in order to stroke actuators).

Storage should be indoors and the units should be protected against humidity and other harmful elements.

Assembling type A = Fail Clock-wise application

FIGURES
1A - 1B - 1C - 1D

Cut away top views of **GT** spring return actuators, for Fail Clock-Wise applications **Assembling type A** (fig.1A), and Fail Counter Clock-wise applications, **Assembling type C** (fig.1C).

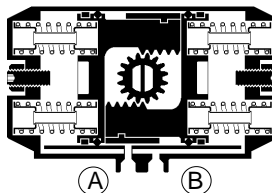

Figure 1A (Closed position)

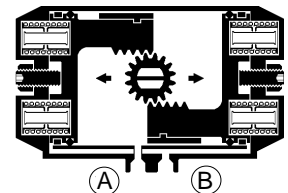

Figure 1B (Open position)

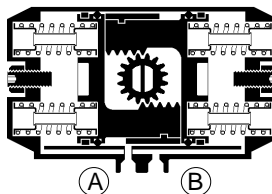

Figure 1C (Closed position)

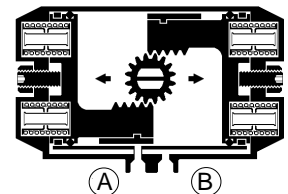



Figure 1D (Open position)

Assembling type C = Fail Counter Clock-Wise application

3.0 OPERATION CHARACTERISTICS

The  actuators have simple operational characteristics:

- Port **(A)** is connected to the interior cavity between the pistons
- Port **(B)** is connected to the end caps cavity directing the air flow into the end caps area.

AIR TO AIR ACTUATORS

In figure 1.a we see that by pressurizing port **B** and allowing air to exhaust through port **A** we have the normally **closed** position for the actuator.

If we exchange the pressurization from **B** to **A** and the exhaust from **A** to **B** (as shown in figures 1.B e 1.D), the pinion will rotate in the counter clockwise direction and we'll see the **open** position of the actuator.

SPRING RETURN ACTUATORS

In the case of SPRING RETURN actuators, with the pressurizing of port B and the port A connected to the exhaust, in the case of air failure spring return will satisfy the conditions shown in figures 1.A e 1.C.

Although the  actuators typically operate, counter clockwise to open and clockwise to close, it is possible to change this style of operation.

Figures 1.C e 1.D show the same spring return actuator with the piston orientation changed to convert the actuator from a fail clockwise to a fail counter clockwise unit (as described in Section 10.0: FCCW to FCW conversion).

4.0 ACTUATORS INSTALLATION

The  actuators are designed to be easy to install. The actuators come with one or more ISO 5211 (DIN 3337) standard bottom mounting pattern, selon the model, for direct assembling to the valves to be driven or to the coupling, when necessary.

On top face of  actuators there is a NAMUR standard mounting pattern for easy installation of accessories for position survey and/or control devices (Microswitches box, Positioners, etc).

The pinions of  actuators are the uniques on the market having, as standard, a **poligonal** bottom female key, that allow the assembling on valves stem, or coupling, with square key at 45° or at 90° indifferently.

On request, bottom pinion female key may be done at double D or cylindrical with one or two keyways:



Poligonal key



Double D key



Keyways key

The ports are NAMUR standard, for easy solenoid valve connection, on GTX.110 through GTX.255, while on GTX.52 through GTX.92, that have proprietary type ports, it is available a special mounting adapter plate for connection with NAMUR standard solenoid valves (See figure 9, pag. 12).

For these lower dimensions actuators, are available spacial solenoid valves, of G.T. Componenti production, for easy direct assembling on the actuator, as NAMUR standard ones, avoiding the adapter plate needing (See pag. 12).

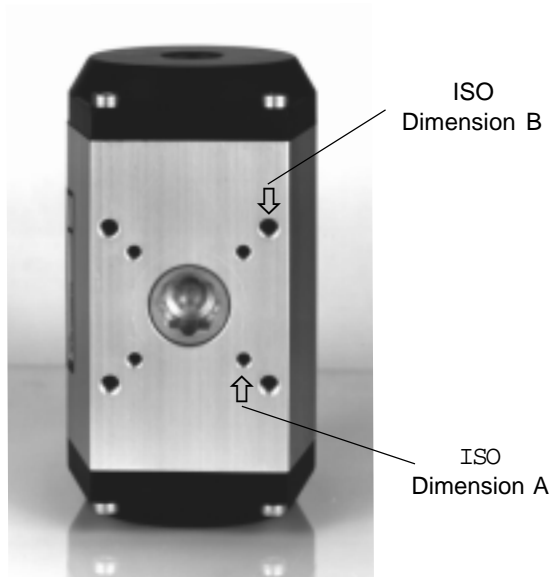
**FIGURA 2**

Bottom view of the  actuator with ISO standard mounting dimensions.

TIPO	Dimens. A ISO Ø mm		Dimens. B ISO Ø mm.	
GTX. 52	F03	36	F05	50
GTX. 63	F05	50	F07	70
GTX. 75	F05	50	F07	70
GTX. 83	F05	50	F07	70
GTX. 92	F05	50	F07	70
GTX.110	F07	70	F10	102
GTX.118	F07	70	F10	102
GTX.127	F07	70	F10	102
GTX.143	F10	102	F12	125
GTX.160	F10	102	F12	125
GTX.190			F14	140
GTX.210			F14	140
GTX.254			F16	165
GTX.255			F16	165
GTX.300			F16	165

TABLE 1

ISO dimensions represents actuator mounting bolt circles

FOR ACTUATORS INSTALLATION PLEASE FOLLOW THESE STEPS:

4.1 - Insert valve stem directly into actuator pinion, or through the coupling if necessary, to check for proper fit.

NOTE.: If actuator is **DOUBLE ACTING** check to see if pinion is in the normal position, or rather in the position necessary to get the valve closed.

4.2 - Make sure valve is in normal position before proceeding. Figure 3 describes the correct normal position of all G.T. Componenti actuators (Including spring return types with FCW, **assembling A** and FCCW **assembling C**, applications).

4.3 - Install mounting bracket on to valve and hand tighten all fasteners. **Be sure not to fully torque bolts until entire assembly is correctly aligned and installed.**

4.4 - Place coupling on valve stem, if necessary, and position actuator on mounting brackets. Align valve and actuator assembly so as to eliminate shear force on system.

Rotate the actuator to open direction (normally counter clockwise) as regards to the valve until to eliminate all torsional play in closing direction, just to get correct closing valve position in correspondence of actuator closing position (piston close to piston, see figures 1A and 1C), then tighten all assembly fasteners to appropriate torque specification given in table 3, pag. 9).

FIGURE 3

Top view of a **GT** actuator. Figure 3 shows an actuator in the normal position (closed) with the pinion flats and the indicator-drive milling perpendicular to the body.

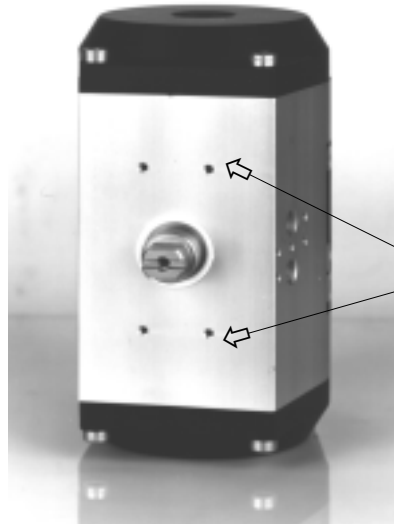

Limit Switches and Positioner mounting area..

- 4.5 -** Actuate unit pneumatically several times to ensure that coupling is not binding.
If unit does not function properly, disassemble fixture and actuator coupling, and repeat steps from **4.1** through **4.5**.
If problem persist contact your local G.T. Attuatori representative.

- 4.6 -** After all mounting procedures are completed, it is necessary to set travel stops, to ensure proper rotation.

The **GT** travel stops allow for a range of about 95° to 85°. If a larger range is necessary consult directly G.T. Attuatori people for information on Extended final limit stops.

NOTE: Improper setting of travel stops can reduce the actuators life.

- 4.7 -** Rotate actuator and valve assembly to desired degree. (it is best to consult valve Installation & Maintenance sheet to determine the correct set point for the valve).

- 4.8 -** Loosen both sealing nuts. Torque travel stops until they contact the pistons.
Be sure not to alter the valve and actuator position while setting the travel stops.
Torque the sealing nuts until secure.
Retest actuator to assure that there are no end cap air leaks.

5.0 DISASSEMBLY PROCEDURE

- 5.1 - Disconnect all electrical and air supplies from the actuator.

**CAUTION:
 NEVER DISASSEMBLE AN ACTUATOR THAT
 IS UNDER PRESSURE**

- 5.2 - Remove actuator from mounting bracket and coupling (when present).
 Disassemble accessories as: limit switches, microswitches box and positioner (if present), and place in clean environment.

- 5.3 - Remove the eight screws and remove end caps.

- 5.4 - Remove O-Rings from end caps.

NOTE: unless actuator has not been in service it will be better to replace the O-Ring set. (See table 2A at page 8)



FIGURE 4

This figure shows the actuator pinion rotated until pistons disengage from pinion rack.



FIGURE 5

This figure demonstrates the removal of pinion through the bottom of the actuator.

- 5.5 - Rotate pinion in Counter Clockwise direction (NOTE: if unit is a FCCW, assembling C, rotation will be in opposite direction) until pistons are far enough from cylinder to be removed by hand.

If pistons are too difficult to remove by hand, it is acceptable to use a pair of pliers to assist in removal of them. (NOTE: be sure not to scar the surface of pistons).

Remove both pistons noting the orientation of them, so during reassembly the pistons will be replaced in the same orientation.

**CAUTION
 NEVER USE COMPRESSED AIR TO PULL OUT
 THE PISTONS FROM THE ACTUATOR BODY**

5.6 - Remove snap ring and delrin washer from top of pinion. Place the actuator between two blocks of wood so that the pinion is free to be removed through the bottom of the actuator body.

Using a rubber mallet, lightly tap the top of the pinion. When the pinion is loose from the body remove the pinion through the bottom (See figure 5).

The O-Rings and guide kits contains the following items:

#	Q.ty	Description
1	2	O-Ring (Piston)
2	2	O-Ring (End Cap)
3	1	O-Ring (Shaft Upper)
4	1	O-Ring (Shaft Lower)
5	2	O-Ring (Travel Stops)

TABLE 2A : O-RINGS SET

#	Q.ty	Description
1	2	Piston Guide Skate
2	2	Piston Guide Ring
3	1	Shaft (Upper Guide)
4	1	Shaft (Lower Guide)
5	1	Shaft (Upper Washer)

TABLE 2B : SERIE GUIDE

6.0 ASSEMBLY PROCEDURE

6.1 - Inspect all wear surfaces for excessive wear or possible damage

CAUTION:
**BE SURE THAT ALL PARTS ARE STILL WITHIN FACTORY SET
 TOLERANCES BEFORE ASSEMBLY**

6.2 - Make sure all metallic parts are clean and free of any nicks or burrs.

6.3 - Lubricate the inside bore of the cylinder body, ORings seats, pistons and pinion wear surfaces with ESSO MULTI-PURPOSE GREASE E compatible grease, suitable for use from -30°C through + 140°C.

NOTE: All O-Rings should be replaced as a matter of service policy if the actuator has been in service..

6.4 - Install wear surface skates and bearings on pistons and pinion, and install O-Rings on pistons, pinions and end caps.

6.5 - Insert pinion into actuator body. Install pinion washer and snap ring (seeger).

6.6 - Insert pistons into cylinder body until the pistons begin to mesh with the pinion.

Make sure that the pistons are symmetrically placed inside the cylinder body.
 In figure 4 we see that the pistons are at the mating position and are symmetrical. **This is very important**.
 Infact, if the pistons are not tracking properly remove and reinsert them.

NOTE: Be sure that tooth engagement is even on both pistons.

6.7 - Apply equal pressure on each piston until they are fully engaged with pinion.
 Rotate pinion until actuator is fully closed.

6.8 - Check the top of pinion for correct orientation. If the indicator-drive milling is perpendicular to the cylinder body then proceed to the next part 6.9.
 If the pinion is incorrectly positioned , then proceed to part 6.8b.

6.8b - Turn actuator up on its side. Rotate pinion counter clockwise until both pistons disengage from pinion.
 Rotate pinion with a wrench to correct position. Apply light pressure to pistons until pinion and pistons engage.
 Close actuator and check for correct pinion orientation, as at section 6. (Repeat this step as many times as necessary to get the correct orientation).

FIGURE 6

The figure shows the internal view of an end cap, as it must be assembled on actuator body, with part A on the top and the part B on the bottom.
 Look at the O-Ring

Caution: with upturned end caps, the actuator cannot operate.

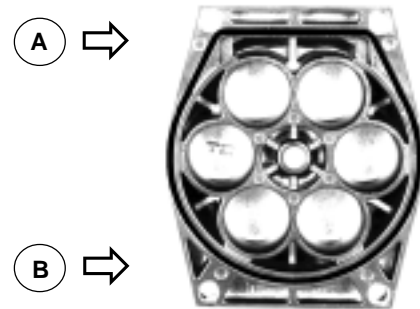

6.9 - In case of SPRING RETURN actuator insert cartridge springs. (For information on the loading of springs refer to section 7.0).

6.10 - Replace end caps, being sure to position them in correct way. (See Figure 6).

N.OTE: Torque screws in alternating order to ensure that the O-Ring seats properly.

6.11 - End cap screws should be torqued, in alternating order, to the factory standard. Refer to below table 3 for correct bolt torque specifications.

ACTUATORS MODEL	SCREWS	TORQUE in Nm.	NUT Adjustment Nm
GTX. 52 - 63	M5	8	2
GTX. 75 - 83 - 92	M6	12	3
GTX.110 - 118 - 127	M8	15	4.5 (for 127 8 Nm)
GTX. 143 - 160	M10	20	8
GTX.190 - 210	M12	28	13
GTX.254 - 255 -300	M14	40	20 (for 300 30 Nm)

TABLE 3

End cap fasteners torque specifications.

CAUTION:
**NEVER GIVE COMPRESSED AIR TO THE ACTUATOR
 BEFORE TO CHECK VERY WELL
 IF PINION IS FIXED BY SNAP RING (SEGER)
 AND END CAPS WELL CLOSED WITH TIGHTENED SCREWS**

6.12 - Pressurize right port on actuator body to test for air leaks. Leaks can occur around pinion and between end cap and body mating surfaces.

If an air leak is found near the end cap, remove end cap and check for proper O-Ring seating.

If O-Ring appear to be in good condition, repeat the step 6.11.

Presurize left port on actuator to test for pinion air leaks. If an air leak develops near the pinion and body mating areas, remove the pinion from the body, as at point 5.6 taking well care that pistons do not change position inside the actuator body, during this operation.

Inspect upper and/or lower pinion O-Rings, selon where the leak is found

If O-Rings appear in good condition, verify for burrs into O-Ring grooves. Clean very well and reinsert O-Rings in their seats.

Insert pinion into actuator body in the same orientation as before, taking well care not to move pistons. If pistons are moved repeat steps from point 6.5. Install pinion washer and snap ring.

Begin test again as described in this section.

If the problem persist contact your local G.T. Attuatori representative.

7.0 CARTRIDGE SPRINGS INSTALLATION

The  actuators have the unique ability to be field converted from DOUBLE ACTING to a SPRING RETURN actuator type, or viceversa, by changing very easily the spring configuration inside the end caps. (NOTE: refer to table 3 on next page).

The  actuators can accept up to 6 cartridge springs in each end cap, also if very rarely they are less than 2.

The number of cartridge springs loaded into the actuator affects the amount of torque the actuator will be able to generate during the closing and opening portions of the cycle.

Review sections **11**, **12** and **13** on actuator sizing, for correct procedures in selectint spring combinations.

7.1 - Drive the actuator in closed position (See figures 1 at pag. 3).

7.2 - Remove end caps.

7.3 - As it is not possible to see the rack position with pistons assembled into actuator body, refer to  mark present in one of springs seats of the piston, corresponding to which there is the rack on the other side of the piston. (See figure 7: that seat is numbered 1).

7.4 - Fixed the number of cartridge springs to put in **each** cap, insert them according to table 3 and figure 7. (Example: Model GTXN.110x90.NP22A.K4 has **4** cartridge springs per end cap).

8.0 SOLENOID VALVES SPACIFICATIONS

G.T. Attuatori solenoid valves are designed for long life, with only one par sealing of air compressed flow.

FIGURE 7

The figure shows the front view of a piston with the cartridge spring seats numbered, and the rack position.

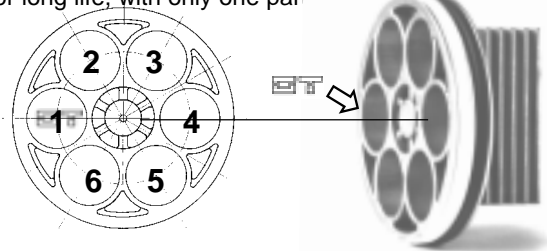

Total number of cartridge springs	1	2	3	4	5	6
Cartridge springs locations.	1	1 - 4	2 - 4 - 6	2-3-5-6	1-2-3-5-6	All positions.

TABLE 3
Cartridge springs orientation chart.

7.5 - When reassemble the end caps pay attention not to overturn them. Looking at the O-Ring, be sure to place end caps with (A) on the top and (B) on the bottom.

FIGURE 8

The figure shows the internal view of an end cap, as it must be assembled on actuator body, with part A on the top and the part B on the bottom. Look at the O-Ring

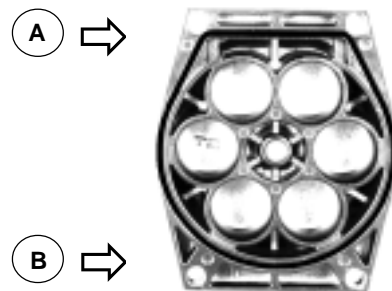

Caution: with upturned end caps, the actuator cannot operate.

The solenoid valves have Buna-N O-Rings to seal inlet and outlet ports. The plunger return is pneumatically performed by differential pressure, without springs.

G.T. Attuatori offers solenoid valves both with NAMUR standard mount, for direct mounting on actuators from GTX.110 through GTX.255, and proprietary type mount for direct mounting on actuators from GTX.52 through GTX.92.

Although G.T. Attuatori uses a proprietary mounting pattern for smaller actuators, G.T. Componenti also offers a special adapter plate to allow for a NAMUR standard pattern solenoid valves to be mounted on any **GT** actuator, as shown in figure 9.

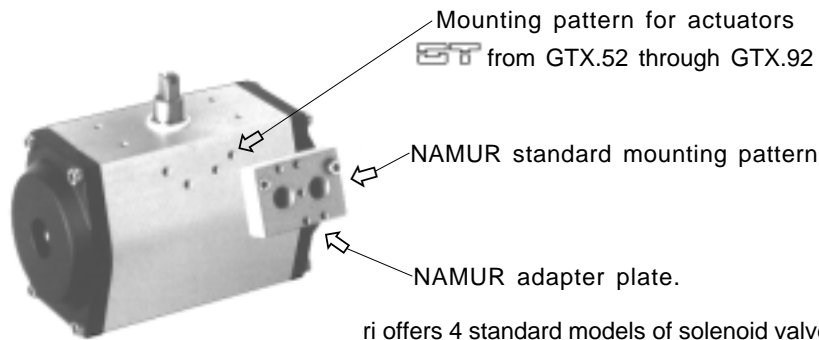

FIGURE 9

GTXN.92x90 actuator with NAMUR adapter plate

ri offers 4 standard models of solenoid valves:

Voltages:	24 - 48 - 110 - 220	V / AC. (50-60Hz.)
	12 - 24 - 110	V / DC.
Consumption:	3.5 Watt (DC.)	5 VA (AC.)
Pressures:	Min. = 2.5 Bar	Max. = 10 Bar

- 1 - SV.1 Single Solenoid, ports 1/4" NPT Mounting on actuators with NAMUR adapter plate: from GTX.45 through GTX.92
 Direct mounting on actuators: from GTX.110 through GTX.300
 KV Factor = 9

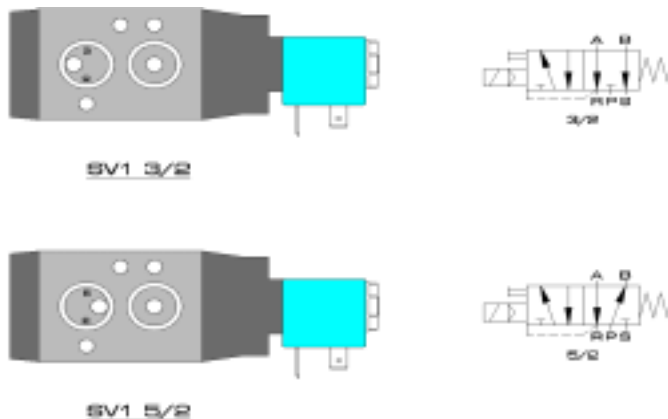

In addition to these 4 standard models of solenoid valves, with nylon fiberglass filled coils, G.T. Attuatori offers also Epoxy Resin filled coils, for all standard voltages and also for other voltages, when request, always with same consumption data.

- 2 - SV.2 Double Solenoid, ports 1/4" NPT Mounting on actuators with NAMUR adapter plate:
 from GTX.45 through GTX.92
 Direct mounting on actuators: from GTX.110 through GTX.300
 KV Factor = 9

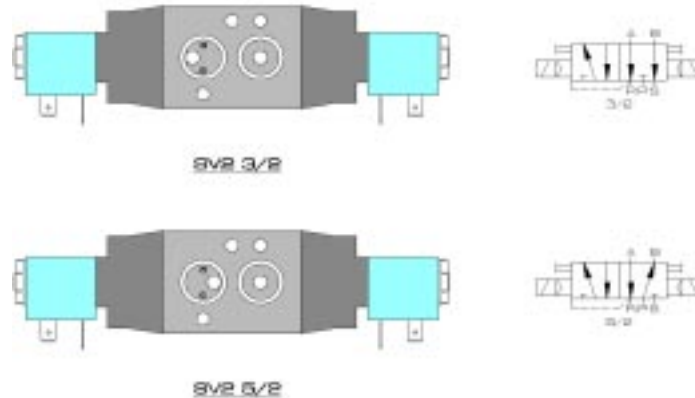

- 3- SV.2-VC Double Solenoid, ports 1/4" NPT Mounting on actuators with NAMUR adapter plate:
 from GTX.45 through GTX.92
 Direct mounting on actuators: from GTX.110 through GTX.300
 KV Factor = 9

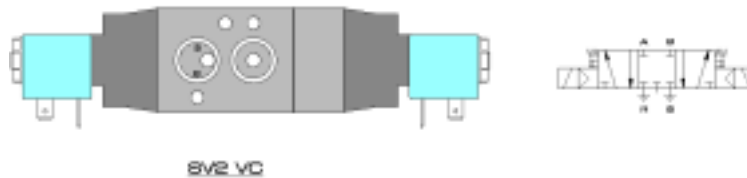

- 4- SV.2-VS Double Solenoid, ports 1/4" NPT Mounting on actuators with NAMUR adapter plate:
 from GTX.45 through GTX.92
 Direct mounting on actuators: from GTX.110 through GTX.300
 KV Factor = 9

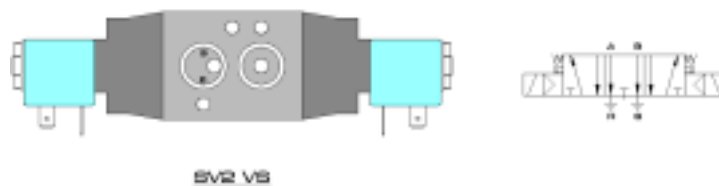

G.T. Attuatori offers 2 standard models of Pneumatic command valves:

- 1 - PV.1 Single pneumatic command port 1/8" GAS, ports 1/4" NPT
 Mounting on actuators with NAMUR adapter plate: from GTX.45 through GTX.92
 Direct mounting on actuators: from GTX.110 through GTX.300
 KV Factor = 9



PV1 3/2

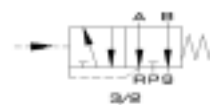

PV1 5/2

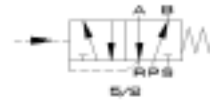

- 2- PV2 Double pneumatic command port 1/8" GAS , ports 1/4" NPT
 Mounting on actuators with NAMUR adapter plate: from GTX.45 through GTX.92
 Direct mounting on actuators: from GTX.110 through GTX.300
 KV Factor = 9



PV2 3/2

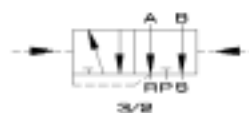

PV2 5/2

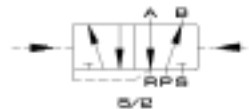

G.T. Attuatori also offers coils for low consumption (1.4 W - 2 VA), for Explosion Proof (EExm II T4) and Intrinsically safe (EEx ib IIc T6).

For more information require G.T. Attuatori for proper literature.

9.0 SOLENOID VALVES INSTALLATION

9.1 - Choose appropriate sized direct mounting solenoid valve.

If you are using a solenoid valve not designed to be direct mounted to actuator, assembly will require actuator to valve piping.

9.2 - Affix the solenoid valve to side of actuator with 2 M5x25 socket head screws, supplied with the solenoid valve, inserting in the middle suitable O-Rings into the port seats **A** and the Commutation Disk Pack into the port seats **B**.

Connect supply line to solenoid valve central port (**Supply**).

Pressurize line and check for possible leaks.

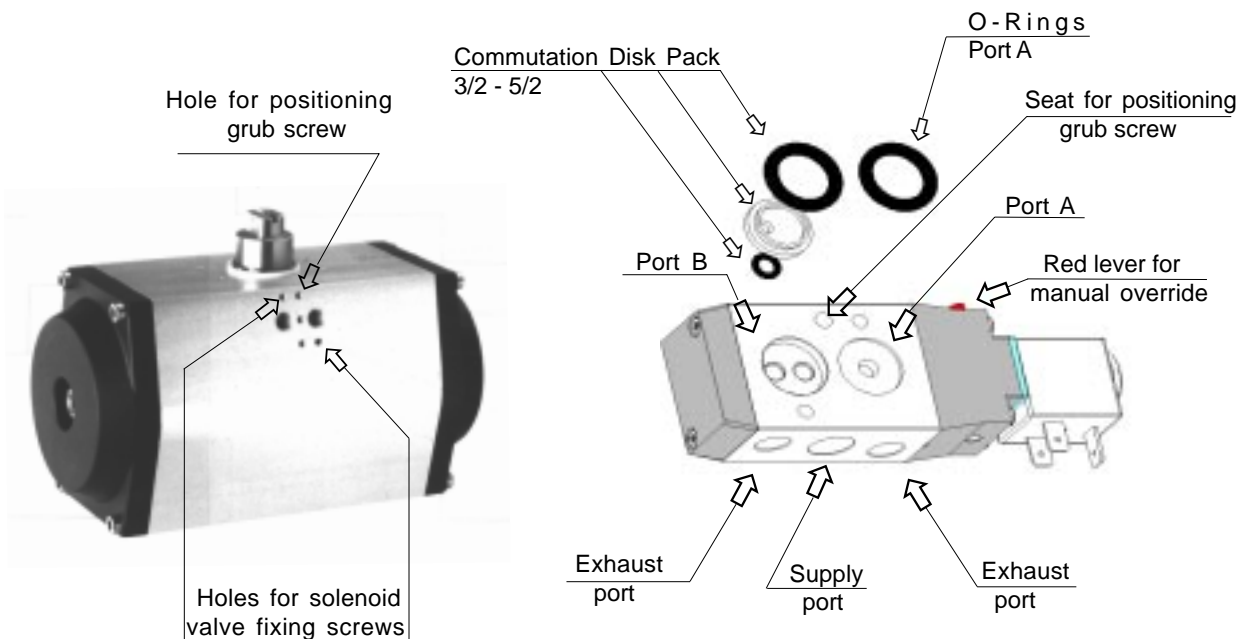

FIGURE 10
Solenoid valve type: **SV1. NAMUR**

9.3 - G.T. Attuatori solenoid valves are equipped with manual override.

By rotating for 180°, on position ① little red lever, present on solenoid pilot base and normally on position ②, the solenoid valve is manual operated and then the actuator is operated too. Returning little red lever in position ③, everything will go back to starting position.

10.0 FCW TO FCCW CONVERSION

The **EST** actuators typically comes from the factory as Fail Clock-wise (FCW) units, that is **Mounting A**, that allows infact FCW operation.

In the event that the need of the actuator changes from FCW to a Fail Counter Clock-wise (FCCW) actuator that is **Mounting C**, **EST** actuators can easily be field converted to this configuration, following next steps:

- 1 - Remove end caps, pistons and the pinion as described in the disassembly procedure. (Section 5.0). Prior to reassembly rotate both pistons 180° along the long axis of the piston. (See figure 12). Upon rotation of pistons, reassembly can be accomplished by following the reassembly instruction in Section 6.0, Parts 6.1 to 6.12 of this manual.

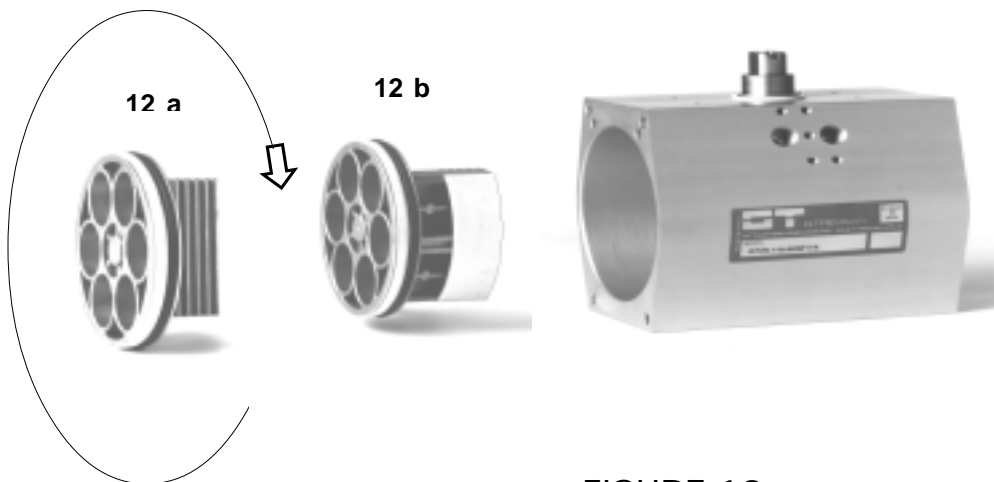

FIGURE 12

Rotate the piston shown in Fig. **12 a** as in position shown in Fig. **12 b**, to obtain the FCCW configuration (**Mounting C**)

**REMEMBER: IN CASE OF SPRING RETURN TYPE, RE-INSERT CARTRIDGE SPRINGS BEFORE END CAPS ASSEMBLING ACCORDINGLY WITH TABLE 3, SPRING ORIENTATION CHART
 REPLACE CARTRIDGE SPRINGS IF NECESSARY**

10.2 - After this procedure has been accomplished, you should be able to put air into the right air port and move the actuator to the normal position. (If the actuator is not already in the normal position)

When air is placed in the left port, the actuator now rotates in the clock-wise direction first and then in the counter clock-wise direction when returning in its normal position.

Logically, in the case of **SPRING RETURN** type, the return in normal position by counter clock-wise rotation will happen just when the air will be put to the exhaust from left air port.

11.0 ACTUATOR SIZING

Prior to actuate sizing it is important to get certain information. Key numbers to get are as follows:

- ◆ - Torque required to open the valve.
- ◆ - Torque required to close the valve.
- ◆ - Actuator air pressure.
- ◆ - Differential pressure of Valve/Damper.

Obtaining the above information allow you to properly and effectively size a SPRING RETURN actuator. (NOTE: DOUBLE ACTING actuators have a constant torque throughout their entire stroke).

When determining the air supply pressure it is important that you use the **minimum** air pressure that the actuator will experience and not the average air supply pressure.

If an actuator is supplied by a lower air pressure than it is sized for, failure or improper performances can occur.

12.0 AIR TO AIR ACTUATORS

12.1 - Select the largest torque (opening or closing torque) and, increase that number of 10%.
(NOTE: Adding 10% is done to ensure an acceptable factor of safety).

The data published in the sizing table indicates **average** capacity for that given pressure.

12.2 - Using above-mentioned sizing table, look in the column that corresponds to the supply pressure you have selected. Move down the chart until you have found a torque which is **larger** than the torque determined for your application.

After you have found the correct value, move across the table horizontally to determine the correct actuator.

13.0 SPRING RETURN ACTUATOR

13.1 - Increase both your valve closing torque and your valve opening torque by 20%. (Again this will provide an acceptable factor of safety).

**NOTE: THE VALVE CLOSING TORQUE CORRESPONDS TO
THE SPRINGS END COLUMN
AND THE VALVE OPENING TORQUE CORRESPONDS TO
THE ACTUATOR AIR PRESSURE COLUMN**

EXAMPLE

Given information: Valve Opening Torque (**VOT**) = 85 Nm.
 Valve Closing Torque (**VCT**) = 80 Nm.
 Minimum pressure available = 5 Bar

20% increase of **VOT** = 90 x 1.2 = 102 Nm. total
 20% increase of **VCT** = 85 x 1.2 = 96 Nm. total

Type		SPRINGS 0°	5 Bar
GTXN.127x90	K2	51	195
	K3	76	150
	K4	102	105
	K5	127	60
	K6	153	15

NOTE: this table is an excerpt from the sizing chart provided by G.T. Componenti s.r.l.

To satisfy all conditions of this application, we compare the VOT to column marked SPRING 0°, and the VCT to column of 5 Bar. Since the GTXN.127x90.K4 satisfies both conditions we select this actuator.

14.0 ACTUATOR CYCLE TIME

14.1 Move down the SPRING 0° column and the actuator pressure column (remember to use the correct actuator air pressure column) until you find torque values, in the same row, that are larger than the two valve torque values.

Follow across that row to determine the actuator size and cartridge spring configuration.

Note: Stroke time is equal for opening and closing strokes.
 Time shown is for entire go-and-back cycle.
 Cycle tested at 6 Bar and with 75% load of available torque.

TYPE	CYCLE TIME (Sec.)
GTX. 52x90	0.158
GTX. 63x90	0.214
GTX. 75x90	0.333
GTX. 83x90	0.429
GTX. 92x90	0.444
GTX.110x90	0.461
GTX.118x90	0.600
GTX.127x90	0.857
GTX.143x90	1.580
GTX.160x90	1.620
GTX.190x90	3.220
GTX.210x90	3.330
GTX.254x90	6.000
GTX.255x90	7.500
GTX.300x90	9.340



15.0 SAFETY INSTRUCTIONS

15.1 - Pneumatic actuators  of GTX series have been planned and manufactured in accordance with ATEX 94/9/CE Standard, Group II, category 2 GD, with reference to the Norm UNI EN 1127-1 and UNI EN 13463-1

15.2 - Marking



15.3 - Marking description

	Marking in conformity with applicable European Directives
	Marking in conformity with Directive 94/9/CE and to related technical norms
II	Group II (surface)
2	Device of category 2
GD	Explosive atmosphere with presence of gas, vapours, fogs and dusts
c	Manufacturing safety
T 110°C	Maximum surface temperature
Tech. File N° 2003/1	Technical brochure number

16.0 DANGEROUS AREAS

Dangerous area	Installation category in accordance with ATEX 94/9/CE Directive	
Gas, fogs, vapours and dusts	Zone 1/21	2 GD
Gas, fogs, vapours and dusts	Zone 2/22	3 GD

16.1 - Pneumatic actuator suitability to installation place.

In case of use in areas with explosion danger, must be verified that the actuator is suitable to zone classification and to inflammables peculiarity present on the plant.

Safety fundamental requirements against explosion risk into classified areas are fixed by European Directives 94/9/CE dated March 23, 1994 (for devices) and 1999/92/CE dated December 1999 (for plants).

16.2 - Places with presence of gas, inflammable fogs, vapours and dusts.

Classification standard of explosion risk areas are indicated by EN 60079-10 Norm (Classification of dangerous places for gas presence) and EN 550281-3 (Classification of dangerous places in which may be present combustible dusts).

Based on these technical and lawgiving instructions, pneumatic actuator choice must consider following factors:

- Plant type
- Zone classification: 0, 1, 2, 20, 21, 22 (for which are suitable devices respectively of category 1, 2, 3)
- Features of Inflammable substances present disguised as gases, vapours or fogs and layer of dust.
- Subgroup; IIA, IIB, IIC.
- Temperature class: T6 (defines gases ignition temperature)
- T (maximum surface temperature)



ATTUATORI
- PNEUMATIC ACTUATORS AND ACCESSORIES -

INSTALLATION OPERATION & MAINTENANCE MANUAL

WARRANTY

The G.T. Attuatori guarantees own actuators for a period of one year starting from delivery date.

The guarantee cover possible defects of the material manufactured by G.T. Attuatori.

Because of the above mentioned guarantee the G.T. Attuatori undertake to make reparation or substitution, of those parts that will retain really defectives for own responsibility, to perform in own works and ex factory.

The guarantee decays in the following cases:

- Product utilization condition not suit as shown in the technical specifications.
- Product installation not properly done.
- Product utilization for different applications from those for which is prepared.

In any case, however, the guarantee implicates the repayment possibility.

The G.T. Attuatori doesn't recognize any other guarantee, worded or implicitly except for above mentioned.

The G.T. Attuatori also excludes any other responsibility coming from damages, direct or indirect, of any type or kind coming from own products or from the use of the same.