

## Highlights

- Multiple sensor design (up to 8 heads for 1 box)
- Plug & Play (automatic head detection from the box)
- High temperature resistance for the head up to 180°C (356°F) without cooling
- Multiple spectral ranges covered by one sensor model
- Extended temperature range for LT head up to 1000°C (1832°F)
- Dedicated 5 µm head for measuring of glass
- Laser sighting for 1M/2M sensing heads
- Spot sizes down to 0.5 mm (0.02 in) with Close Focus Lens
- Fast 10 ms response time
- Industrial rugged head cable (PUR): Silicone and Halogen free, resistant against oil, bases, and acids
- Networkable OEM head model (without a box)
- Intrinsically safe sensing heads with dedicated Ex-power supply

### Measurement Specifications

<b>Temperature Range</b>	
LTS02, LTS10, LTH10	-40 to 600°C (-40 to 1112°F)
LTS20, LTF, LTH20	0 to 1000°C (32 to 1832°F)
G5	250 to 1650°C (482 to 3002°F)
2M	250 to 1400°C (482 to 2552°F)
1M	500 to 1800°C (932 to 3272°F)
<b>Spectral Response</b>	
LT	8 – 14 µm
G5	5 µm
2M	1.6 µm
1M	1 µm
<b>Optical Resolution<sup>1</sup></b>	
LTS (standard)	2:1, 10:1, 22:1 typ. (21:1 guaranteed)
LTH	10:1, 22:1 typ. (21:1 guaranteed)
LTF (fast)	10:1
G5	10:1
1M, 2M	100:1
<b>Accuracy<sup>2</sup></b>	
LT, G5	± (1% of reading or 1°C) <sup>3,4</sup>
1M, 2M	± (0.5% of reading + 2°C)
<b>Repeatability</b>	
LT, G5	± 0.5% of reading or ± 0.5°C <sup>3</sup>
1M, 2M	± (0.25% of reading + 1°C)
<b>Temperature Coefficient</b>	
LT, G5	± 0.05 K / K or ± 0.05% / K of reading <sup>3</sup>
1M, 2M	± 0.01% / K of reading
<b>Response Time<sup>5</sup></b>	
LTS (standard), LTH	130 ms
LTF (fast)	20 ms
G5	130 ms
1M, 2M	10 ms
<b>Emissivity ε</b>	
	0.100 to 1.100
<b>Transmission</b>	
	0.100 to 1.000
<b>Signal Processing</b>	
	Peak hold, valley hold, adjustable up to 998 s variable averaging filter

<sup>1</sup> 90% energy

<sup>2</sup> at ambient temperature 23°C ± 5°C (73°F ± 9°F), ε = 1.0, and calibration geometry

<sup>3</sup> whichever is greater

<sup>4</sup> ± 2°C (± 4°F) for target temperatures < 20°C (68°F)

<sup>5</sup> 90% value

## MI3 Heads

### Datasheet



### General Specifications

<b>Ambient Temperature</b>	
LT, G5	-10 to 120°C (14 to 248°F)
LTH	-10 to 180°C (14 to 356°F)
1M, 2M	0 to 120°C (32 to 248°F)
Laser (1M, 2M)	automatic switch off at 65°C (149°F)
<b>Storage Temperature</b>	
LTH	-20 to 180°C (-4 to 356°F)
all other models	-20 to 120°C (-4 to 248°F)
<b>Environmental Rating</b>	
	IP65 (NEMA-4)
<b>EMC</b>	
	EN 61326-1:2006

### Dimensions

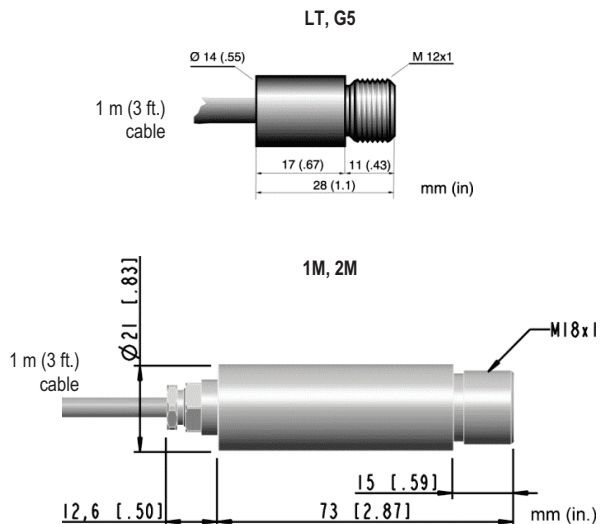

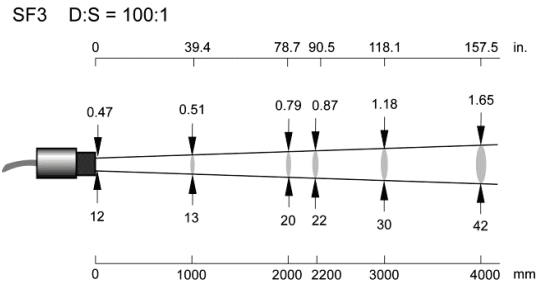
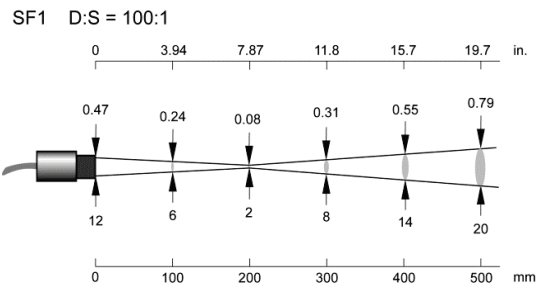
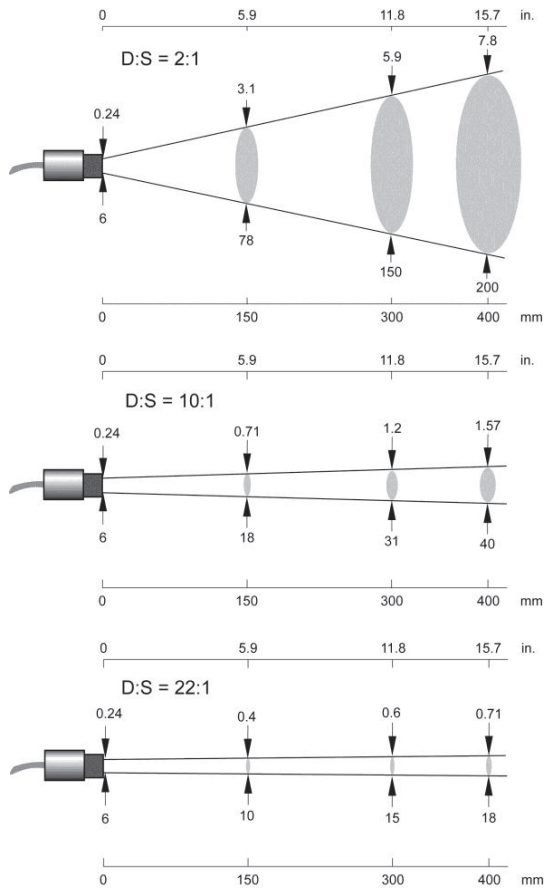

## Optical Specifications (90% energy)





## Intrinsic Safety

Intrinsically safe sensing heads (MI3...IS):

-  II 2G Ex ib IIC T4 Gb (gas)
-  II 2D Ex ib IIC T135°C Db (dust)

Ex Power supply (MI3ACIS):

-  II (2)G [Ex ib Gb] IIB (gas)
-  II (2)D [Ex ib Db] IIC (dust)

## Accessories

Accessories include items that may be ordered at any time and added on-site:

- Adjustable Bracket (LT, G5: XXXMIACAB / 1M, 2M: XXXMI3100ADJB)
- Fixed Bracket (LT, G5: XXXMIACFB / 1M, 2M: XXXMI3100FB)
- Isolation Kit for Fixed Bracket (1M, 2M: XXXMI3100ISOKIT)
- Air Purge (LT, G5: XXXMIACAJ / 1M, 2M: XXXMI3100AP)
- Air Cooling Jacket (XXXMIACCJ: 0.8 m/2.6 ft, XXXMIACCJ1: 2.8 m/9.2 ft) for ambient temperatures up to 200°C/392°F (LT, G5 only)
- Close Focus Lens (LT, G5: XXXMI3ACCFL)
- Protective Window (LT, G5: XXXMIACPW / 1M, 2M: XXXMI3100PW)

### Air Purge Jacket



for LT, G5 heads  
(XXXMIACAJ)



for 1M, 2M heads  
(XXXMI3100AP)

## Options

Options must be specified at time of order.

- Longer head cable lengths: 3 m, 8 m, 15 m, 30 m (9.8, 26, 49, 98 ft.)
- Water cooled housing (1M, 2M heads)
- Networkable OEM sensing head without the need for a box

### Water Cooled Housing (1M, 2M)



## Sensing Heads

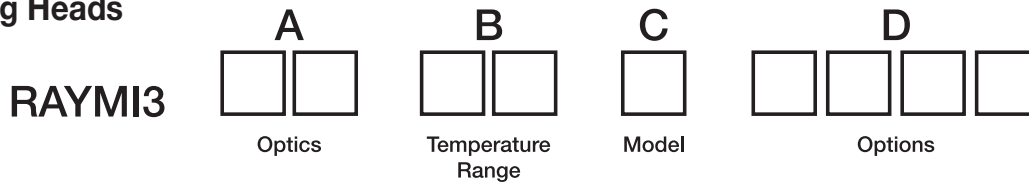

Each MI3 sensor system is comprised of (1) MI3 sensing head and (1) MI3COMM or MI3MCOMM communication module. The sensing head includes one mounting nut and 1m (3.3ft) cable. Longer cables up to 30 m (100ft) maximum are available and must be specified at time of order. The MI3 sensing head and MI3COMM box are ordered as separate items.

Model	Description
RAYMI3	Miniature infrared sensing head with 1 meter (3.3ft) cable
Code A	Optical Resolution
02	2:1
10	10:1
20	22:1
Code B	Temperature Range
LT	-40°C to 600°C (-40°F to 1112°F) Note: 0°C to 1000°C (32°F to 1832°F) for LTF and LTS 22:1 models
G5	250°C to 1650°C (482°F to 3002°F)
Code C	Model
S	Standard sensing head, 120°C (248°F) maximum ambient
F	Fast response sensing head, 20 mSec response time, 120°C (248°F) maximum ambient (10:1 head only)
H	High ambient sensing head, up to 180°C (356°F)
Code D	Options
CB3	3m (10ft) cable
CB8	8m (26ft) cable
CB15	15m (49ft) cable
CB30	30m (98ft) cable

## Communication Boxes

Model	Description
RAYMI3COMM	MI3 IR thermometer communication box with USB 2.0 communications, cast zinc housing and user-interface
RAYMI3COMM4	MI3 IR thermometer communication box with USB 2.0 communications and RS-485 communication option, cast zinc housing and user-interface
RAYMI3COMM	MI3 IR thermometer communication box with USB 2.0 communications and Modbus communication option, cast zinc housing and user-interface
RAYMI3COMMP	MI3 IR thermometer communication box with USB 2.0 communications and Profibus communication option, cast zinc housing and user-interface
RAYMI3MCOMM	Modular DIN mountable 4-channel IR communication box with user interface, USB 2.0 and RS485 communications
RAYMI3MCOMM	Modular DIN mountable 4-channel IR communication box with user interface, USB 2.0 and Modbus communications
RAYMI3MCOMMP	Modular DIN mountable 4-channel IR communication box with user interface, USB 2.0 and Profibus communications
RAYMI3MCOMMN	Modular DIN mountable 4-channel IR communication box with no user interface, display or RS485 interfaceIncludes USB 2.0 and alarm relay, only
RAYMI3MCOMMA	Modular DIN mountable 4-channel IR communication box with user interface, USB 2.0 and 4 galvanic isolated analog outputs
RAYMI3COMME	MI3 IR thermometer communication box with USB 2.0 communications and Ethernet communication and built in HTTP-Server option, cast zinc housing and user-interface
RAYMI3COMMPN	MI3 IR thermometer communication box with USB 2.0 communications and Profinet communication, cast zinc housing and user-interface
RAYMI3COMME	Modular DIN mountable 4-channel IR communication box with user interface, USB 2.0 and Ethernet interface with built-in HTTP-Server.
RAYMI3COMMPN	Modular DIN mountable 4-channel IR communication box with user interface, USB 2.0 and Profinet interface.

## Sensing Heads

RAYMI3

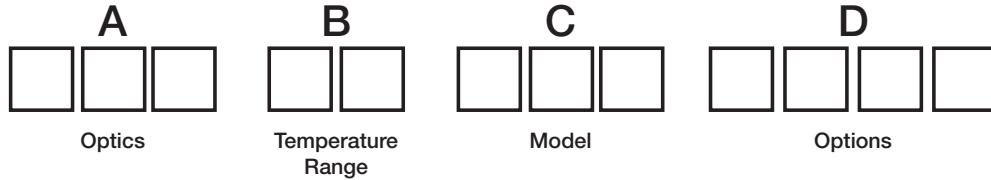

Each MI3 sensor system is comprised of (1) MI3 sensing head and (1) MI3COMM or MI3MCOMM communication module. The sensing head includes one mounting nut and 1m (3.3ft) cable. Longer cables up to 15m (50ft) maximum are available and must be specified at time of order. The MI3 sensing head and MI3COMM box are ordered as separate items.

Model	Description
RAYMI3	Miniature infrared sensing head with 1m (3.3ft) cable
<b>Code A</b>	<b>Optical Resolution</b>
100	100:1
<b>Code B</b>	<b>Temperature Range</b>
1M	500°C to 1800°C (932°F to 3272°F)
2M	250°C to 1400°C (482°F to 2552°F)
<b>Code C</b>	<b>Optical Focus</b>
SF1	200mm focus distance
SF3	2,200mm focus distance
<b>Code D</b>	<b>Options</b>
CB3	3m (10ft) cable
CB8	8m (26ft) cable
CB15	15m (50ft) cable

## Communication Boxes

Model	Description
RAYMI3COMM	MI3 IR thermometer communication box with USB 2.0 communications, cast zinc housing and user-interface
RAYMI3COMM4	MI3 IR thermometer communication box with USB 2.0 communications and RS-485 communication option, cast zinc housing and user-interface
RAYMI3COMMM	MI3 IR thermometer communication box with USB 2.0 communications and Modbus communication option, cast zinc housing and user-interface
RAYMI3COMMP	MI3 IR thermometer communication box with USB 2.0 communications and Profibus communication option, cast zinc housing and user-interface
RAYMI3MCOMM	Modular DIN mountable 4-channel IR communication box with user interface, USB 2.0 and RS485 communications
RAYMI3MCOMMM	Modular DIN mountable 4-channel IR communication box with user interface, USB 2.0 and Modbus communications
RAYMI3MCOMMP	Modular DIN mountable 4-channel IR communication box with user interface, USB 2.0 and Profibus communications
RAYMI3MCOMMN	Modular DIN mountable 4-channel IR communication box with no user interface, display or RS485 interfaceIncludes USB 2.0 and alarm relay, only
RAYMI3MCOMMA	Modular DIN mountable 4-channel IR communication box with user interface, USB 2.0 and 4 galvanic isolated analog outputs
RAYMI3COMME	MI3 IR thermometer communication box with USB 2.0 communications and Ethernet communication and built in HTTP-Server option, cast zinc housing and user-interface
RAYMI3COMMPN	MI3 IR thermometer communication box with USB 2.0 communications and Profinet communication, cast zinc housing and user-interface
RAYMI3COMME	Modular DIN mountable 4-channel IR communication box with user interface, USB 2.0 and Ethernet interface with built-in HTTP-Server.
RAYMI3COMMPN	Modular DIN mountable 4-channel IR communication box with user interface, USB 2.0 and Profinet interface.



Raytek is an ISO 9001 certified company

© 2015 Raytek Corporation (4106811 Rev E) 4/2015  
 Raytek, the Raytek logo and DataTemp are registered trademarks of Raytek Corporation.  
 Modbus is a registered trademark of the Modbus Organization, Inc.  
 Specifications subject to change without notice.