



## Time of flight sensor LDS 400

- **Measuring range** 300-4000 mm
- **Digital resolution** ≤ 0.9 mm
- **Switching frequency** 100 Hz / 500 Hz
- **2x PNP or NPN, 4-20mA, RS485**

### Specification:

The LDS 400 series offers an innovative laser distance sensor with time of flight measurement. This technology is based on the measurement of the time between the emission and the receipt of the laser light pulses. In the 300-4000 mm distance range, it provides a very accurate measurement independent of the target's colour with 12 bit resolution and high linearity. A 4-digit display on the sensors top visualises the value of the measured distance in mm, as well as all the parameters that can be set with three pushbuttons. The LDS 400 sensors have two switching outputs, available as PNP or NPN models, that can be set at different distances, while the measurement value is supplied at the 4-20 mA analogue output and RS485 interface. This interface can also be used to set all the parameters. A response time selection with 5 ms normal and 1 ms fast response is available.



### Applications:

- | Distance measurement
- | Thickness measurement
- | Presence control
- | Automatic control for coiling/uncoiling machines
- | Distance measurement for overhead conveyors
- | Distance measurement up to 1200 °C hot steel

### Advantages:

- | Wide measuring range
- | High linearity
- | 2 switching points
- | Highly shock- and vibration-resistant
- | 4-digit display
- | Connector turnable
- | Visible laserbeam

## Dimensions

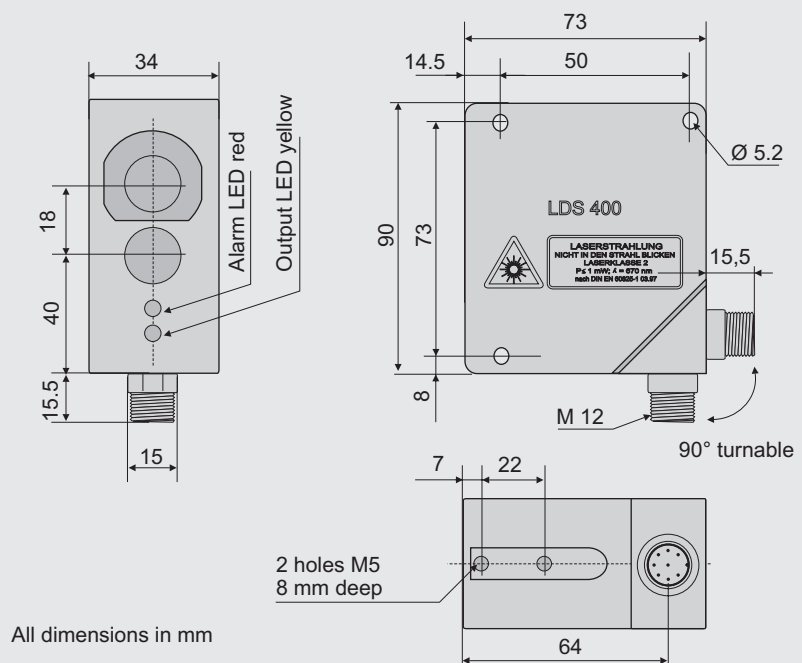

## Wiring connections

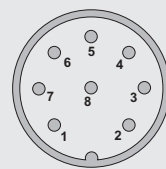

Plug connector M12

- |      |                 |
|------|-----------------|
| 1 wh | Rx/Tx -         |
| 2 bn | +10-30VDC       |
| 3 gn | Analogue output |
| 4 ye | Output 1        |
| 5 gr | Output 2        |
| 6 pi | Rx/Tx +         |
| 7 bl | GND             |
| 8 rd | SYNC            |

## Operating and display elements

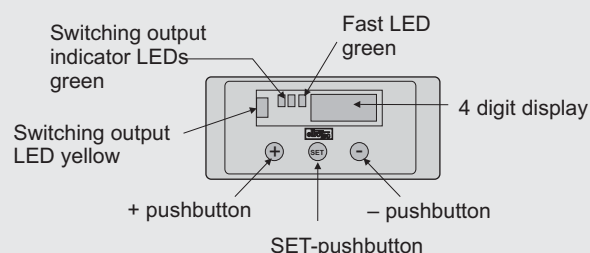

## Technical data

<b>Electrical data</b>	Supply voltage	15 - 30 VDC
	Ripple	max. 2Vpp
	Current consumption typ.	max. 170 mA (110 mA at 24V)
	Data memory	EEPROM
<b>Specific data</b>	Measuring range (at specified surf. reflection)	300 - 4000 mm (18% grey to 90% white) 400-2500 (at 6% black)
	Digital resolution (RS485)	<sup>3</sup> 0.9 mm
	Analogue resolution	<sup>3</sup> 3 mm
	Response time	5 ms (normal), 1 ms (fast)
	Switching frequency	100 Hz (normal), 500 Hz (fast)
	Linearity	typ. 0.3 % (at 24VDC, at 90% white surface, 25 °C)
	<b>Outputs</b>	Switching outputs
Analogue output		4-20 mA
Input		SYNC-input, PNP
Serial connection		RS485, 9600 Bd
<b>Light source</b>	Wave length	665 nm
	Laser class	2 (EN 60825-1:1994)
	Measuring spot size typ.	~ Ø 12 mm at 2000 mm distance ~ Ø 20 mm at 4000 mm distance
<b>Ambient conditions</b>	Operating temperature	-10 to +50 °C
	Storage temperature	-20 to + 70 °C
	Protection	IP 67
	Ambient light protection	according to EN 60947-5-2
	Vibration	0,5 mm amplitude, 10-55 Hz according to EN 60068-2-6
	Shock resistance	11 ms (30 G) , acc.to EN60068-2-27
<b>Housing</b>	Material	Aluminium housing, optical elements: Glas
	Weight	approx. 330 g
	Connections	8-pol plug connector, M12, turnable

## Ordering information

Laser Distance Sensor	Part No.
LDS 400/RS485/PNP	10652680
LDS 400/RS485/NPN	10652683

Accessories	
Cable 3 m, 8-pin, M12 plug	11232681
Cable 5 m, 8-pin, M12 plug	11232682



**LASER CLASS 2  
EN 60825-1:1994**

**Do not stare  
into beam!**

### Application

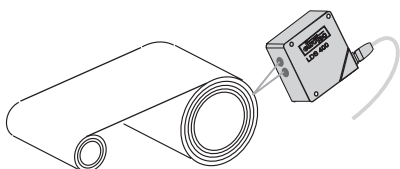

Distance measurement on paper, coils or films

Presented by:

# Operating and display elements LDS400

## LED indicators on LDS400 frontside

- OUTPUT LED** Yellow LED indicates an active Output (Output 1 OR Output 2)
- ALARM LED** The red ALARM LED indicates a missing receiver signal

## Pushbuttons and Display on top

- OUTPUT LED** Yellow LED indicates an active Output (Output 1 OR Output 2)
- Display (green, 4-digit)** In normal working mode, the distance in mm is shown on the display
- LED OUT1, OUT2** Green LED1 indicates the activated switching output 1  
Green LED2 indicates the activated switching output 2
- LED FAST** Green LED3 indicates the activated FAST mode (500 Hz)
- SET-pushbutton** A short press on this key activates the self-setting procedure.  
A long pressure on the key allows the user to access into the mode (FAST/NORM) and the setting of output delay.
- +/- pushbuttons** Short pressure on this key allows the user to run through parameters and the settings menu of the sensor.  
Long pressure allows to change the switching threshold value. (see also "Switching threshold adjustment")

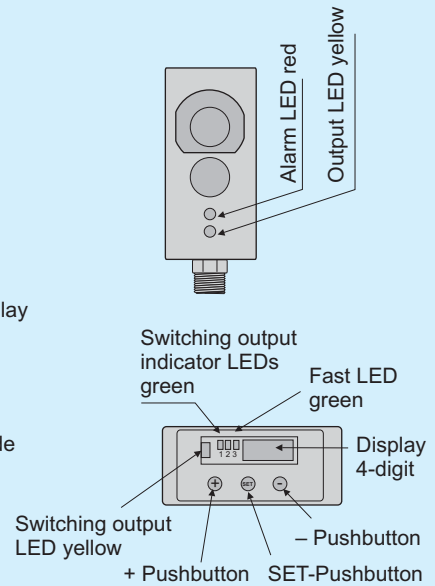

## Switching diagram

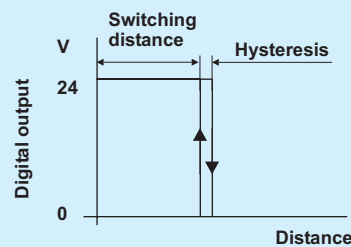
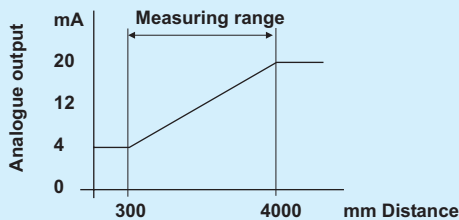

## RS485 serial connection

The RS485 serial interface allows the complete remote control of the sensor. All functions as channel status, normal/fast mode selection or output delay can be configured by serial connection. The serial communication parameters are:

**9600 baud, non-parity, 8 data bits, 1 stop bit.**

The **SYNC**-input is used to determine the communication direction.

SYNC active (LOW) LDS400 -> user  
 SYNC passive (HIGH) user -> LDS400

With **SYNC** active, the sensor continuously transmits the detected distance value (with a precision of 12 bit) by means of a binary data format. 2 byte are used; one with bit 0 at logic level 1 identifies the high byte.

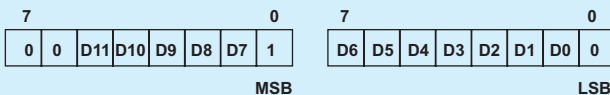

All the commands have to be sent via terminal in ASCII-format according to the following:

### - Remote configuration:

To access the remote configuration mode, SYNC-input must be passive. (SYNC passive = HIGH)

The available commands are:

- @ <CR> <LF> beginning of remote setting mode
- cx <CR> <LF> channel selection, with x. {1,2}
- vxxx <CR> <LF> distance selection, with xxx {0-4095}
- bx <CR> <LF> dark/light mode selection, with x {1,2}
  - b1 = dark-switching
  - b2 = light-switching
- e <CR> <LF> memorisation to the configuration sequence
- q <CR> <LF> exit from remote setting mode without saving

At the receipt of the 'q' <CR> <LF> or 'e' <CR> <LF> -commands, the sensor visualises **ok <CR> <LF>**

### - Delay configuration:

To access the remote configuration mode, SYNC-input must be passive.

(SYNC passive = HIGH). The available commands are:

- @ <CR> <LF> beginning of delay configuration
- dx <CR> <LF> delay selection with x {0,1,2,3,4,5}
  - d0 = 0 ms d3 = 20 ms
  - d1 = 5 ms d4 = 30 ms
  - d2 = 10 ms d5 = 40 ms
- e <CR> <LF> memorisation of the new delay value
- q <CR> <LF> exit from delay setting mode without saving

At the receipt of the 'q' <CR> <LF> or 'e' <CR> <LF> -commands, the sensor visualises **ok <CR> <LF>**

### - Normal/ fast mode configuration:

To access the remote configuration mode, SYNC-input must be passive. (SYNC passive = HIGH). The available commands are:

- @ <CR> <LF> beginning of remote setting mode
- mx <CR> <LF> operating mode selection with x {1,2}
  - m1 = normal
  - m2 = fast
- e <CR> <LF> execution of configuration sequence
- q <CR> <LF> exit from remote setting mode without saving

At the receipt of the 'q' <CR> <LF> or 'e' <CR> <LF> -commands, the sensor visualises **ok <CR> <LF>**

### - Receipt of the channel status:

At any moment, the receipt of the 'r' <CR> <LF> remote command (and SYNC passive), the sensor configuration is restored.

### NOTE:

The single digits have to be distanced amongst themselves at least 1 ms, during the command transmission.

# Settings LDS400

## Setting of the 2 channels

### Detection

Place the object to detect in front of the sensor.  
The actual distance value in mm is shown on display.  
By pressing the **SET**-button (for at least 2 sec.) you will reach the channel selection.

### Channel selection

To select the channels, press the +/- - buttons.  
You confirm the selection by a short press (0,5 s) of the **SET**- button and will reach the dark/light-selection.

### Dark/light-mode

To select the dark/light mode of the channels, use the +/- -buttons.  
Press the **SET** - pushbutton again for at least 0,5 sec.  
On display, the "updt" message starts to blink ( 4Hz, for 2 s)  
The detection distance value appears on display, LED for the memorised channel is active. The +/- -pushbuttons can be used to change the detected distance value. (Units change if the pushbuttons pressed repeatedly, the tens if the buttons keep pressed)  
Press the **SET**- button again for at least 0.5 s to end the setting of the channels phase.

## Display

1945	Distance value
CH-1	
CH-2	
L On	Light switching
d On	Dark switching
updt	Settings saved
1945	Distance value

## Switching threshold adjustment

### Channel selection

Press the +/- - button for at least 2 sec. the "CH 1"- message appears.  
To select the channels, press the +/- - buttons.  
You confirm the selection by a short press (0,5 s) of the **SET**- button

### Distance of threshold phase

The previously detected distance value appears. With a press of the +/- -pushbuttons the detected distance value can be changed, (Units change if the pushbuttons pressed repeatedly, the tens if the buttons keep pressed).  
Press the **SET**- button again for at least 0.5 s to end the threshold adjustment phase.

1945	
CH-1	
1945	saved value
1960	new value

## Setting of the parameter

Press the **SET**-button for at least 6 s to enter into the parameter setting menu.  
By pressing the +/- - pushbuttons, the user can run up and down within this menu.

### Switching frequency

Use the **SET**-pushbutton to select the decided option. Setting of normal or fast mode is equal to both outputs.

### Delay setting

The delay value setting is equal to both channels. When a delay value, different from zero, is set, outputs are active for at least the time (in ms) as shown in the display.

Setting: with the **SET** pushbutton you can run through the available delay steps.  
You confirm the selection by pressing the **SET**- button again.

MEnu	
nOrM	normal, 100 Hz
FASt	fast, 500 Hz
d-00	no delay
d-05	5 ms
d-10	10 ms
...	20 ms
d-40	30 ms
	40 ms

### Quick status display

At each pressure of the **SET**-button, the user can run through the options of the selected channel. By pressing the **SET** -button repeatedly, all options will be visualized sequentially.

CH-1
1945
L On
CH-2
...
SAVE

### Memorisation of the parameter set

Pressing the **SET**-button (the "SAVE"-message blinks for 2 s, 4 Hz) all the changed values are saved and the user exits from the menu and returns to normal mode.  
To return to the setting menu, one of the +/- -buttons has to be pressed.

After a 10 s inactivity of the pushbuttons, the sensor returns to normal mode visualising the distance.

## Keylock (SET pushbutton block)

The keylock function is activated after powering on, if the SYNC terminal is connected to the positive power supply (+VDC) for at least 1 s.

(After the first second, the **SYNC** signal is available for normal operations)

To deactivate the keylock function, the sensor has to be turned off and re-powered while maintaining the **SYNC** wire not connected or ground connected (GND).

## SYNC-Input

The **SYNC** signal allows to calculate the beginning and the ending instants of the measurement. Reading cycle begins after the transition of the **SYNC** signal from passive to active and the sensor outputs are updated after max. 400  $\mu$ s. All the outputs are deactivated after max. 400  $\mu$ s from the active-passive transition. (SYNC passive=Vcc, SYNC active=GND)

The **SYNC** wire is also used to determine the transmission direction when the RS485 serial connection is used.

