

Technical details

Connection	G1/4, Namur
Nominal size	6 mm
Temperature range	-10°C ... +70°C
Medium	Filtered, oil-free and dried compressed air according to ISO 8573-1:2010, Class 7:2:4, instrument air, free of aggressive additives. Alternatively the pressure dew point must be at least 10°C below lowest occurring ambient temperature.
Materials	Body: Al (anodized), plastic, seals: NBR and POM, inner parts: Al, steel rostfrei and brass
Protection	IP 65 according to EN 60529
	Valves in accordance with 2014/34/EU (ATEX) available. (Chapter 13)

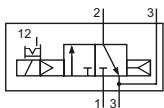

Electrically operated pool valve. The manual override is detent and is operated by screw driver. The location pin, screws and seals are included.

3/2-way-valves

MN-06-310-HN-xxx
 3/2-way, single solenoid, air spring return, NC

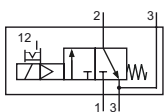

MN-06-311-HN-xxx
 3/2-way, single solenoid, mechanical spring return, NC

Please complete: xxx = electrical option

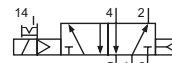
5/2- and 5/3-way-valves

MN-06-510-HN-xxx
 5/2-way, single solenoid, air spring return

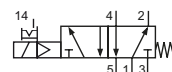

MN-06-511-HN-xxx
 5/2-way, single solenoid, mechanical spring return

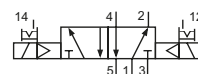

MN-06-520-HN-xxx
 5/2-way, double solenoid

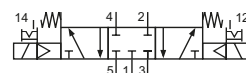

MN-06-530-HN-xxx
 5/3-way, center position closed

Electrical options

Nominal voltage	Power consumption	Specifics	Plug connection*1	-xxx
12 V DC	4.2 W		Form B industrial norm	-441
12 V DC	2.2 W	max. 8 bar	Form B industrial norm	-461
24 V DC	4.2 W		Form B industrial norm	-442
24 V DC	4.8 W		M 12	-O42
24 V DC	2.2 W	max. 8 bar	Form B industrial norm	-462
24 V DC	2.5 W	max. 8 bar	M 12	-O62
24 V AC	7/4 VA		Form B industrial norm	-452
115 V AC	7/4 VA		Form B industrial norm	-456
230 V AC	7/4 VA		Form B industrial norm	-457

*1 Plug socket not included, suitable plug sockets see page 3.

Series MN-06

NAMUR

Technical data

Model-no.:	MN-06-310	MN-06-311	MN-06-510	MN-06-511	MN-06-520	MN-06-530
Operating pressure* (bar)	2...10	3...10	2...10	3...10	2...10	3...10
Pilot pressure* (bar)	2...10	3...10	2...10	3...10	2...10	3...10
Flow rate (NI/min)	750	750	750	750	750	650
Response time (ms) at 6 bar	on: 13 off: 16	on: 13 off: 16	on: 13 off: 16	on: 13 off: 16	on: 12 off: 12	on: 13 off: 15
Weight (kg)	0.320	0.320	0.320	0.320	0.460	0.460

* max. 8 bar at 2.2 W and 2.5 W

Dimensions

MN-06-31x-HN

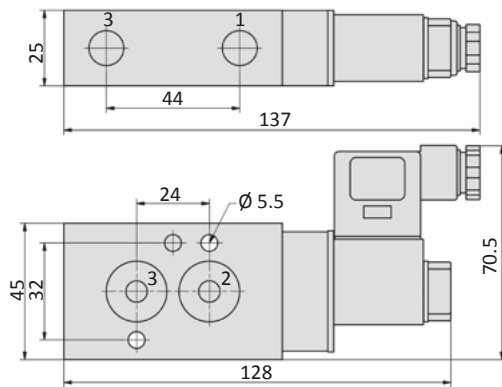

MN-06-51x-HN

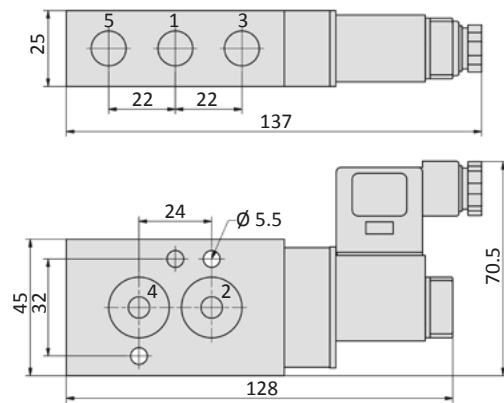

MN-06-520-HN, MN-06-530-HN

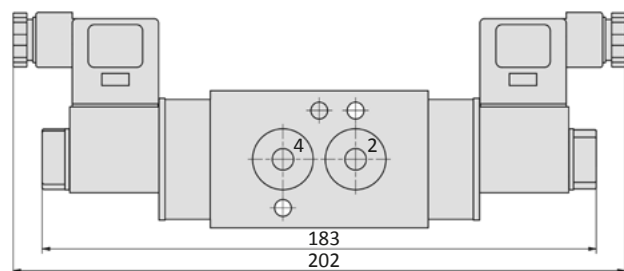

1 = pressure inlet
2,4 = outlets
3,5 = exhausts

Plug socket (not included in scope of delivery) can be repositioned by 180°.
Solenoid coil can be repositioned by 4 x 90°.

Form B according to DIN EN 175301-803

Overall width	22 mm
Contact distance	10 mm
Contacts	2P + E
Protection	IP 65 according to EN 60529 requires a flat gasket
For use with series	



Model-no.:	28-ST-01-G
Voltage (AC/DC)	0 - 250 V
Status indicator	no
Protective circuit	no
Connecting cable	without
Wire cross section	max. 1.5 mm ²
Ø Connecting cable	6 - 8 mm

Form B industrial norm

Overall width	22 mm
Contact distance	11 mm
Contacts	2P + E
Protection	IP 65 according to EN 60529 requires a flat gasket
For use with series	M-04, M-05, M-07, M-22, KM-09, KM-10, MS-18, KN-05, MN-06, MI-01, MI-02, MI-03



Model-no.:	28-ST-01	28-ST-04-112	28-ST-04-127	28-ST-06-112	28-ST-06-127	28-ST-06-K3-112*	28-ST-06-K3-127*
Voltage (AC/DC)	0 - 250 V	10 - 50 V	70 - 250 V	24 V	230 V	24 V	230 V
Status indicator	no	yes	yes	yes	yes	yes	yes
Protective circuit	no	no	no	yes (varistor)	yes (varistor)	yes (varistor)	yes (varistor)
Connecting cable	without	without	without	without	without	3 m	3 m
Wire cross section	max. 1.5 mm ²	max. 1.5 mm ²	max. 1.5 mm ²	max. 1.5 mm ²	max. 1.5 mm ²	3 x 0.75 mm ²	3 x 0.75 mm ²
Ø Connecting cable	6 - 8 mm	6 - 8 mm	6 - 8 mm	6 - 8 mm	6 - 8 mm		

* These plug sockets are fitted with integrated flat gaskets.

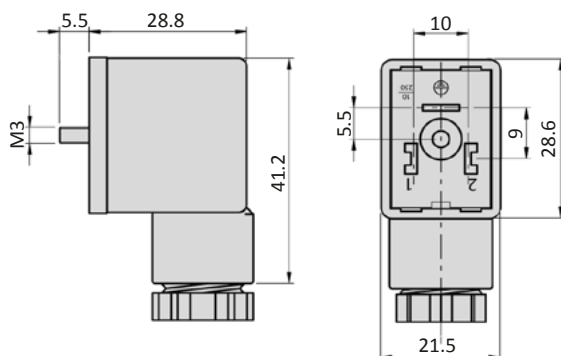
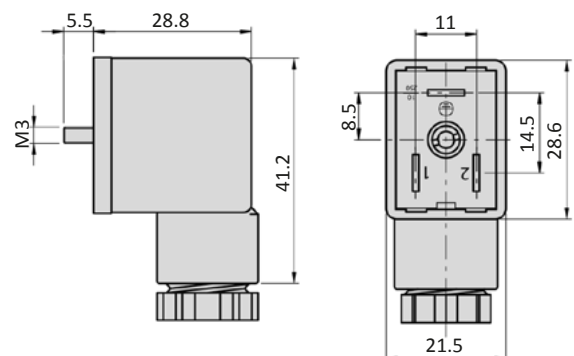
Dimensions
Form B according to DIN EN 175301-803

Form B industrial norm

Plug sockets

Electrically circuits

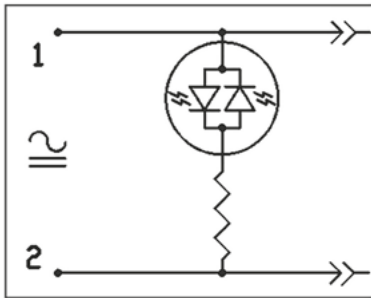
Status indicator (LED)



Status indicator (LED) and protective circuit (varistor)

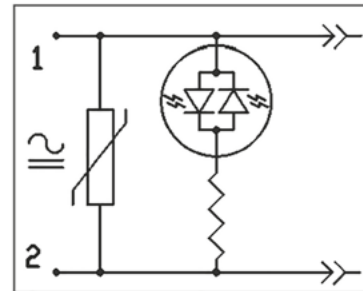

Form B according to DIN EN 175301-803

Overall width	22 mm
Contact distance	10 mm
Contacts	2P + E
Protection	IP 65 according to EN 60529 with connected plug socket
Duty cycle	100 %
Temperature range*	-20°C ... +50°C
Voltage tolerance	± 10 %
For use with series	



* The max. applicable operating temperature, depends on the temperature specification of the used valve.

Model-no.:	23-SP-011-G-412	23-SP-011-G-427
Voltage	24 V DC	230 V AC
Power consumption DC	4.2 W	-
Power consumption AC	-	4.0 VA

5
Form B industrial norm

Overall width	22 mm
Contact distance	11 mm
Contacts	2P + E
Protection	IP 65 according to EN 60529 with connected plug socket
Duty cycle	100 %
Temperature range*	-20°C ... +50°C
Voltage tolerance	± 10 %
For use with series	M-04, M-05, M-07, M-22, KM-09, KM-10, MS-18, KN-05, MN-06, MI-01, MI-02, MI-03



* The max. applicable operating temperature, depends on the temperature specification of the used valve.

Model-no.:	23-SP-011-411	23-SP-011-412	23-SP-011-422	23-SP-011-426	23-SP-011-427	23-SP-012-431	23-SP-012-432
Voltage	12 V DC	24 V DC	24 V AC	115 V AC	230 V AC	12 V DC	24 V DC
Power consumption DC	4.2 W	4.2 W	-	-	-	2.2 W	2.2 W
Power consumption AC	-	-	4 VA	4 VA	4 VA	-	-

Model-no.:	23-SP-011-1-711	23-SP-011-1-712	23-SP-011-1-725	23-SP-011-1-727	23-SP-012-1-732
Voltage	12 V DC/ 24V AC	24 V DC/ 48 V AC	110/115 V AC	230 V AC	24 V DC
Power consumption DC	4.6 W	4.8 W	-	-	2.5 W
Power consumption AC	7.1 VA	7.7 VA	6.0 VA/ 7.6 VA	7.9 VA	-
Specifics	Enhanced humidity resistance.				

Solenoid coils

M12 connection

Overall width	22 mm
Contact distance	-
Contacts	2P
Protection	IP 65 according to EN 60529 with connected plug socket
Duty cycle	100 %
Temperature range*	-20°C ... +50°C
Voltage tolerance	± 10 %
For use with series	



* The max. applicable operating temperature, depends on the temperature specification of the used valve.

Model-no.:	23-SP-011-5-012	23-SP-012-5-032
Voltage	24 V DC	24 V DC
Power consumption DC	4.8 W	2.5 W
Power consumption AC	-	-
Specifics	Mounting on manifold not allowed. With integrated LED and protective circuit.	Min. mounting distance for manifold mounting is 20 mm. With integrated LED and protective circuit.

Dimensions

Form B according to DIN EN 175301-803

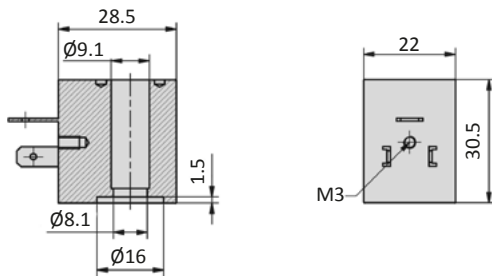

Form B industrial norm

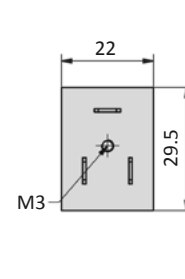

M12 connection

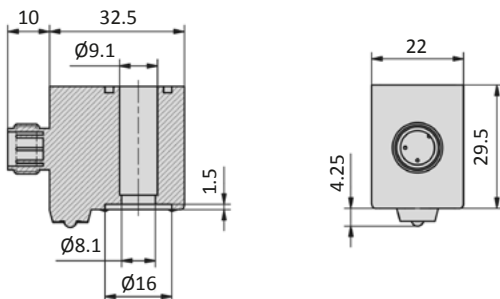

- HN * - * * *					
Manual override	Coil and plug options		Coil type	Manual override position on side of	Voltage
HN detent	0	ATEX 2GD, encapsulated with casting compound width 30 mm	23-SP-037	0 without indication ports 1/3/(5)	0 without indication
HNR detent	1	with coil and plug	according to valve	1 DC ports 1/3/(5)	1 12 V
HNT non-detent	2			2 AC ports 1/3/(5)	2 24 V
	3			3 DC, low power consumption ports 1/3/(5)	3 42 V
	4	with coil, without plug	according to valve	4 DC ports 2/(4)	4 48 V
	5	without coil	no	5 AC ports 2/(4)	5 110 V
	6	without pilot valve	no	6 DC, low power consumption ports 2/(4)	6 115 V
	7	with coil, with enhanced humidity resistance, without plug	according to valve	7 without indication ports 2/(4)	7 230 V
	8	with coil, with enhanced humidity resistance, with plug	according to valve		8 240 V
	9	ATEX 2GD, intrinsically safe, with plug width 30 mm	23-SP-038		9
	A	ATEX 3GD, without plug, width 30 mm	23-SP-040		A 4 V
	B	ATEX 3GD, with plug, width 30 mm	23-SP-040		B 6 V
	C	ATEX 3GD, without plug, width 22 mm	23-SP-041		C 8 V
	D				D 61 V
	E	ATEX 2GD, encapsulated with casting compound width 22 mm	23-SP-036		E 36 V
	F	with coil, with enhanced humidity resistance, without plug, low temperature version	23-SP-060-1		F 9 V
	G				
	H	with coil shape B according to DIN EN 175301-803, with plug	23-SP-011-G		
	I	with coil shape B according to DIN EN 175301-803, without plug	23-SP-011-G		
	J	with coil shape A according to DIN EN 175301-803, without plug (if not standard)	23-SP-016		
	K	with coil shape A according to DIN EN 175301-803, with plug (if not standard)	23-SP-016		
	L	with coil, with plug with LED and protective circuit	according to valve		
	M	with coil, with plug with LED, without protective circuit	according to valve		
	N	with coil with M12 connection	according to valve		
	O	with coil with M12 connection with LED and protective circuit	according to valve		
	P	without connector bridge, without plug			
	Q	with coil with with cable	according to valve		
	R	with cable up to 1 m length	according to valve		
	S	with connector bridge, without plug			
	T				
	U	ATEX 2GD, without coil (for coil 23-SP-036)	no		
	V	ATEX 2GD, Flame proof enclosures and encapsulated with casting compound	23-SP-045		
	W	ATEX 2GD / 3GD, without coil (for coil 23-SP-041 and 23-SP-045)	no		
	X	ATEX 3GD, without coil (for coil 23-SP-040 in 230V AC and 115V AC)	no		
	Y	ATEX 2GD, without coil (for coil 23-SP-038)	no		
	Z	ATEX 2GD / 3GD, without coil (for coil 23-SP-040 in 24V DC and 23-SP-037)	no		

Not all options are suitable for all valve series