

PRESSURE, VACUUM, DIFFERENTIAL PRESSURE, AND TEMPERATURE SWITCHES



FEATURES

- Epoxy Coated Type 4X Enclosure and Stainless Steel Component Parts
- Hermetically Sealed Snap Switch, SPDT or DPDT Output
- Terminal Block Wiring
- Tamper-Resistant Set Point "Lock"
- Adjustable Ranges:
 - Pressure: 30" Hg Vac to 3500 psi (-1 to 241,3 bar)
 - "wc Ranges: 300 "wc vacuum to 250 "wc pressure (-746, 7 to 622,3 mbar)
 - Differential Pressure: 0.8 "wcd to 500 psid (2,0 mbar to 34,5 bar)
 - Temperature: -120 to 640°F (-84.4 to 337.8°C)

OVERVIEW

Approved for Division 2, Zone 2 hazardous and corrosive atmospheres, and with optional Zone 0 intrinsic safety compliance, the 117 Series can be used to measure vacuum, pressure, differential pressure, or temperature in a variety of applications. The rugged, one piece enclosure features a slanted cover for wiring accessibility to the enclosed terminal block that is wired to either a SPDT or DPDT hermetically sealed microswitch. All welded, stainless steel pressure connections and sensors provide superior corrosion resistance – NACE compliant – and fire-safe protection within the harshest environments. The 117 Series is an ideal choice for the most demanding applications; typically steel and aluminum mills, chemical and petrochemical plants, pulp and paper mills, wastewater treatment plants, midstream and downstream oil & gas, and pharmaceutical plants.

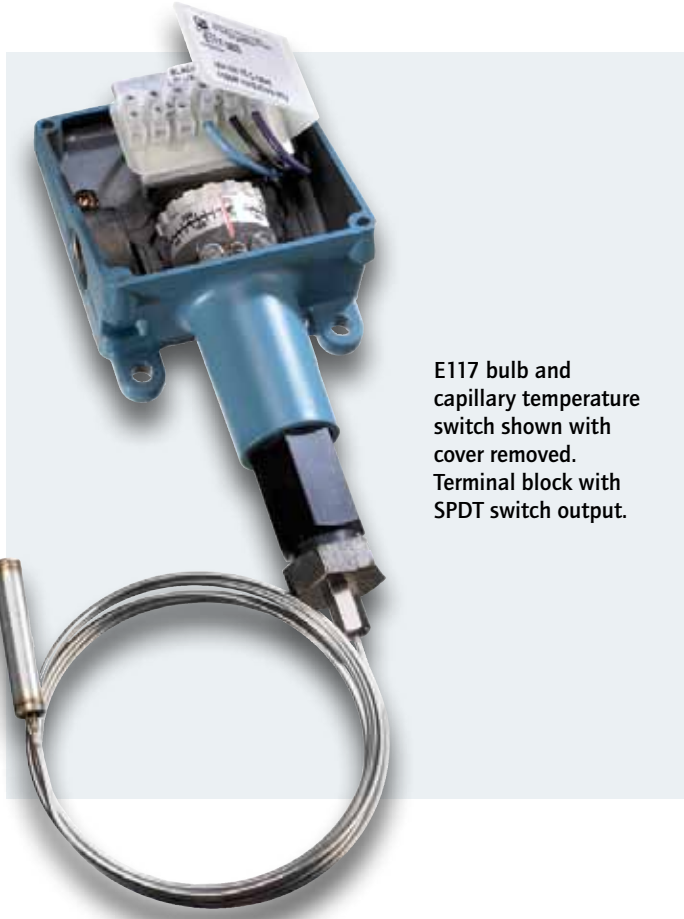

E117 bulb and capillary temperature switch shown with cover removed. Terminal block with SPDT switch output.

FEATURES

- Approved for Division 2, Zone 2 hazardous locations
- Optional ATEX or GOST intrinsic safety compliance for Zone 0
- Hermetically sealed snap switch, SPDT or DPDT output
- Welded stainless steel diaphragms meet NACE MR-0175 standard
- Optional sensor material for corrosive media
- Ultra-low vacuum and pressure ranges
- Polished stainless steel flush mount sensors

SPECIFICATIONS

STORAGE TEMPERATURE	-65° to 160°F (-54 to 71°C)
AMBIENT TEMPERATURE LIMITS	-40° to 160°F (-40° to 71°C); except models 520-525, 540-548, 700-706: 0 to 160°F (-18 to 71°C); set point typically shifts less than 1% of range for a 50°F (28°C) ambient temperature change
SET POINT REPEATABILITY	Temperature models: ± 1% of adjustable range Pressure models 171-174, 218, 358-376, 520-535, 540-543 and 700-706: ± 1% of adjustable range; models 183-194, 544-548, 483-494, 565-567: ± 1.5% of adjustable range Internal set point lock on all pressure models
SHOCK	Set point repeats after 15 G, 10 millisecond duration
VIBRATION	Set point repeats after 2.5 G, 5-500 Hz
ENCLOSURE	Die cast aluminum, epoxy powder coated, gasketed; captive cover screws; anodized aluminum nameplate
ENCLOSURE CLASSIFICATION	Enclosure Type 4X
SWITCH OUTPUT	One SPDT hermetically sealed snap action switch; switch may be wired "normally open" or "normally closed"; DPDT (option 1190/1195)
ELECTRICAL RATING	11 A 125/250 VAC resistive; 5 A @ 28 VDC; 1 A @ 48 VDC; 1/2 A @ 125 VDC; switch contacts gold flashed
WEIGHT	1.5-6.5 lbs. Varies with model
ELECTRICAL CONNECTION	1/2" NPT (female); two 7/8" diameter knockouts
PRESSURE CONNECTION	Models 218, 358-376, 700-706: 1/4" NPT (female); models 171-194, 483-494, 520-535: 1/2" NPT (female); models 565-567: 1.5" flush mount connection (mates with Tri-Clamp® fitting systems), models 540-548: 1/8" NPT (female)
TEMPERATURE ASSEMBLY	Bulb and capillary: 6 feet; 304 stainless steel Immersion stem: nickel-plated brass (standard); optional 316L stainless steel
FILL	Non-toxic oil filled
TEMPERATURE DEADBAND	Typically 4% of range under laboratory conditions (70°F ambient circulating bath at rate of 1/2°F per minute change)
REFERENCE SCALE	Pressure: "High-Low" reference scale Temperature: reference dial

APPROVALS

UE declarations and third-party issued Agency certifications are available for download at www.ueonline.com/prod_approval.



UNITED STATES AND CANADA

UL Listed, **cUL** Certified
 Class I, Division 2, Groups A, B, C & D
 Class II, Division 2, Groups F & G
 Class III
 Enclosure Type 4X
 Pressure: UL 508 & 1604; CSA C22.2 No. 14
 & 213 - File # E40857
 Temperature: UL 508 & 1604; CSA C22.2 No. 24
 & 213 - File # E43374



Low Voltage Directive (LVD) (2006/95/EC)

UEC Compliant to LVD
 Products rated lower than 50 VAC and 75 VDC are outside the scope of the LVD
 The Low Voltage Directive does not apply to products for use in hazardous locations



RUSSIA

Gosgortekhnadzor Permit (**OPTIONAL - code M406**)
 0ExialICT6
 Tamb = -50C to +60C
 NANIO CCVE Certification Center
 Certificate # RRS 00-22739
 GOST R 51330.0, 51330.1, 51330.10 & 51330.14



EUROPEAN UNION

ATEX Directive 94/9/EC

II 1 G Ex ia IIC T6 Ga (**OPTIONAL - code M405**)
 Tamb = -50C to +60C
 UL International DEMKO A/S (N.B.# 0539)
 Certificate # DEMKO 11 ATEX 1105261X Rev. 0
 EN 60079-0:2009, 60079-11:2007, 60079-26:2007



Pressure Equipment Directive (PED) (97/23/EC)

UEC Compliant to PED
 Products rated lower than 7.5 psi are outside the scope of the PED

PRESSURE MODEL CHART

Model	Adjustable Set Point Range		Deadband		*Over Range Pressure		**Proof Pressure	
	Low end of range on fall; High end of range on rise		"wc	mbar	psi	bar	psi	bar
Type H117	"wc	mbar	"wc	mbar	psi	bar	psi	bar
Buna N diaphragm and O-ring with epoxy coated aluminum 1/2" NPT (female) pressure connection; large 0.72" orifice for clean-out purposes (Other wetted materials available - see page 9)								
520	300 Vac to 0	-746,7 to 0	0.8 to 32	2,0 to 79,6	200	13,8	400	27,6
521	10 Vac to 10	-24,9 to 24,9	0.4 to 2.4	1,0 to 6,0	200	13,8	400	27,6
522	50 Vac to 50	-124,5 to 124,5	0.4 to 12	1,0 to 29,9	200	13,8	400	27,6
523	0.5 to 5	1,2 to 12,4	0.4 to 1.2	1,0 to 3,0	200	13,8	400	27,6
524	2.5 to 50	6,2 to 124,5	0.4 to 3.2	1,0 to 8,0	200	13,8	400	27,6
525	10 to 250	24,9 to 622,3	0.4 to 24	1,0 to 59,7	200	13,8	400	27,6
Welded 316L stainless steel diaphragm and 1/2" NPT (female) pressure connection, large 0.72" orifice for clean-out purposes								
530	300 Vac to 0	-746,7 to 0	0.8 to 60	2,0 to 149,3	50	3,4	100	6,9
531	10 Vac to 10	-24,9 to 24,9	0.4 to 2.4	1,0 to 6,0	50	3,4	100	6,9
532	50 Vac to 50	-124,5 to 124,5	0.4 to 12	1,0 to 29,9	50	3,4	100	6,9
533	0.5 to 5	1,2 to 12,4	0.4 to 1.2	1,0 to 3,0	50	3,4	100	6,9
534	2.5 to 50	6,2 to 124,5	0.4 to 3.2	1,0 to 8,0	50	3,4	100	6,9
535	10 to 250	24,9 to 622,3	0.4 to 40	1,0 to 99,6	50	3,4	100	6,9

*Over Range Pressure: The maximum pressure that may be applied continuously without causing damage and maintaining set point repeatability.

** Proof Pressure: The maximum pressure to which a pressure sensor may be occasionally subjected, which causes no permanent damage. The unit may require calibration (e.g. start-up, testing).

Model	Adjustable Set Point Range		Deadband		*Over Range Pressure		**Proof Pressure	
	Low end of range on fall; High end of range on rise							
Type H117	psi	bar (unless noted)	psi	bar (unless noted)	psi	bar	psi	bar
1.5" flush mount, welded 316L stainless steel diaphragm and pressure connection. Mates with Tri-Clamp® fitting systems (not UE supplied)								
565	5 to 30	0,3 to 2,1	3 to 15	0,2 to 1,0	1000	68,9	1500	103,4
566	10 to 100	0,7 to 6,9	3 to 36	0,2 to 2,5	1000	68,9	1500	103,4
567	15 to 300	1,0 to 20,7	9 to 66	0,6 to 4,6	1000	68,9	1500	103,4
Welded 316L stainless steel diaphragm and 1/2" NPT (female) pressure connection, large 0.72" orifice for clean-out purposes; NACE MR-0175 compliant								
171	1 to 20	68,9 mbar to 1,4 bar	0.1 to 3	6,9 mbar to 0,2	500	34,5	1000	68,9
172	2 to 50	0,1 to 3,4	0.1 to 5	6,9 mbar to 0,3	500	34,5	1000	68,9
173	4 to 100	0,3 to 6,9	0.1 to 10	6,9 mbar to 0,7	500	34,5	1000	68,9
174	8 to 200	0,6 to 13,8	0.1 to 15	6,9 mbar to 1,0	500	34,5	1000	68,9
316L stainless steel diaphragm (optional Hastelloy® C or Monel®); Viton® GLT O-ring (optional Kalrez®, Ethylene Propylene, or Aflas®); 316 stainless steel 1/2" NPT (female) pressure connection (optional Hastelloy® C, or Monel®), large 0.72" orifice for clean-out purposes. Models 188 and 189 have a 316L stainless steel 1/2" NPT (female) pressure connection; NACE MR-0175 compliant								
183	1 to 20	0,1 to 1,4	0.3 to 5	20,7 mbar to 0,3	500	34,5	1000	68,9
184	2 to 50	0,1 to 3,4	0.3 to 10	20,7 mbar to 0,4	500	34,5	1000	68,9
185	4 to 100	0,3 to 6,9	0.5 to 16	34,5 mbar to 0,7	500	34,5	1000	68,9
186	8 to 200	0,6 to 13,8	0.5 to 21.5	34,5 mbar to 1,2	500	34,5	1000	68,9
188	50 to 1000	3,4 to 68,9	30 to 300	2,1 to 20,7	2000	137,9	7000	482,6
189	250 to 3500	17,2 to 241,3	50 to 500	3,4 to 34,5	4000	275,8	7000	482,6
316L stainless steel diaphragm (optional Hastelloy® C, or Monel®); Viton® GLT O-ring (optional Kalrez®, Ethylene Propylene or Aflas®); 316 stainless steel 1/2" NPT (female) pressure connection (optional Hastelloy® C, or Monel®), 0.06" orifice to dampen pulsations. Models 488 and 489 have a 316L stainless steel 1/2" NPT (female) pressure connection; NACE MR-0175 compliant								
483	1 to 20	0,1 to 1,4	0.3 to 5	20,7 mbar to 0,3	500	34,5	1000	68,9
484	2 to 50	0,1 to 3,4	0.3 to 10	20,7 mbar to 0,4	500	34,5	1000	68,9
485	4 to 100	0,3 to 6,9	0.5 to 16	34,5 mbar to 0,7	500	34,5	1000	68,9
486	8 to 200	0,6 to 13,8	0.5 to 21.5	34,5 mbar to 1,2	500	34,5	1000	68,9
488	50 to 1000	3,4 to 68,9	30 to 300	2,1 to 20,7	2000	137,9	7000	482,6
489	250 to 3500	17,2 to 241,3	50 to 500	3,4 to 34,5	4000	275,8	7000	482,6

Application Note: The use of metallic diaphragms where higher pressure shock or heavy cycling is expected should be avoided. Models 171-174 should not be used where system or start-up vacuum pressure might exceed 26" Hg Vac (-0,9 bar). Use of optional diaphragm materials for models 483-489 may increase deadband.

Hastelloy® is a registered trademark of Haynes International, Inc.

Monel® is a registered trademark of the Special Metals Corporation

Aflas® is a registered trademark of Asahi Glass

Viton® and Kalrez® are registered trademarks of E.I. DuPont de Nemours and Company

Tri-Clamp® is a registered trademark of Alfa Laval.



PRESSURE MODEL CHART

Model	Adjustable Set Point Range		Deadband			*Over Range Pressure		**Proof Pressure	
	Low end of range on fall; High end of range on rise								
Type H117	psi (unless noted)	bar	psi (unless noted)		bar (unless noted)	psi	bar	psi	bar
Phosphor bronze bellows with nickel-plated brass 1/4" NPT (female) pressure connection; 303 stainless steel spring exposed to media									
218	30 "Hg Vac to 0	-1 to 0	2 to 5 "Hg		0,07 to 0,17	3	0,2	30	2,1
Welded 316L stainless steel bellows and 1/4" NPT (female) pressure connection									
358	15 to 200	1,0 to 13,8	6 to 20		0,4 to 1,4	200	13,8	800	55,2
361	20 to 300	1,4 to 20,7	8 to 22		0,6 to 1,5	300	20,7	800	55,2
376	25 to 500	1,7 to 34,5	10 to 28		0,7 to 1,9	500	34,5	800	55,2
			Lower 75% range span	Top 25% range span	Lower 75% range span				
			psi (unless noted)	psi	bar				
Welded 316 stainless steel diaphragm and 1/2" NPT (female) pressure connection, large 0.72" orifice for clean-out purposes; NACE MR-0175 compliant (except model 194)									
190	5 to 30	0,3 to 2,1	3 to 8	10 max	0,2 to 0,6	1500	103,4	2500	172,4
191	10 to 100	0,7 to 6,9	3 to 30	45 max	0,2 to 2,1	1500	103,4	2500	172,4
192	15 to 300	1,0 to 20,7	10 to 40	60 max	0,7 to 2,8	1500	103,4	2500	172,4
193	20 to 500	1,4 to 34,5	15 to 45	75 max	1,0 to 3,1	1500	103,4	2500	172,4
194	80 to 1700	5,5 to 117,2	5 to 120	200 max	0,3 to 8,3	2000	137,9	2500	172,4
Welded 316 stainless steel diaphragm and 1/2" NPT (female) pressure connection, 0.06" orifice to dampen pulsations; NACE MR-0175 compliant (except model 494)									
490	5 to 30	0,3 to 2,1	3 to 8	10 max	0,2 to 0,6	1500	103,4	2500	172,4
491	10 to 100	0,7 to 6,9	3 to 30	45 max	0,2 to 2,1	1500	103,4	2500	172,4
492	15 to 300	1,0 to 20,7	10 to 40	60 max	0,7 to 2,8	1500	103,4	2500	172,4
493	20 to 500	1,4 to 34,5	15 to 45	75 max	1,0 to 3,1	1500	103,4	2500	172,4
494	80 to 1700	5,5 to 117,2	5 to 120	200 max	0,3 to 8,3	2000	137,9	2500	172,4

Deadband Notes: Models 190-194, 490-494 are expressed as the lower 75% and top 25% of the range span because of the operating characteristics of the welded stainless steel diaphragm sensor and hermetically sealed switch.

*Over Range Pressure: The maximum pressure that may be applied continuously without causing damage and maintaining set point repeatability.

** Proof Pressure: The maximum pressure to which a pressure sensor may be occasionally subjected, which causes no permanent damage. The unit may require calibration (e.g. start-up, testing).

***Working Pressure Range: The pressure range within which two opposing sensors can be safely operated and still maintain set point adjustability provided the difference in pressure between them does not exceed the designated adjustable range.

Model	Adjustable Set Point Range		Deadband		*Over Range Pressure		**Proof Pressure	
	Low end of range on fall; High end of range on rise							
Type H117	psi	bar	psi	bar	psi	bar	psi	bar
Buna N diaphragm and O-ring with 316 stainless steel 1/4" NPT (female) pressure connection; option M540 Viton® diaphragm and O-ring available								
700	3 to 20	0,2 to 1,4	1,0 to 4	0,1 to 0,3	500	34,5	1000	68,9
702	3 to 100	0,2 to 6,9	2 to 12	0,1 to 0,8	500	34,5	1000	68,9
704	15 to 500	1,0 to 34,5	15 to 30	1,0 to 2,1	1500	103,4	2500	172,4
706	100 to 1700	6,9 to 117,2	20 to 110	1,4 to 7,6	2000	137,9	2500	172,4

DIFFERENTIAL PRESSURE MODEL CHART

Model	Adjustable Set Point Range		Deadband		***Working Pressure		**Proof Pressure	
	Low end of range on fall; High end of range on rise							
Type H117K	psid (unless noted)	bar (unless noted)	psi (unless noted)	bar (unless noted)	psi (unless noted)	bar	psi	bar
Buna N diaphragm and sealing diaphragms with epoxy coated aluminum 1/8" NPT (female) pressure connections								
540	0.8 to 7 "wcd	2,0 to 17,4 mbar	0.1 to 1.3 "wc	0,2 to 3,2 mbar	30 "Hg to 200	-1 to 13,8	400	27,6
541	2 to 20 "wcd	5,0 to 49,8 mbar	0.2 to 1.6 "wc	0.5 to 4,0 mbar	30 "Hg to 200	-1 to 13,8	400	27,6
542	5 to 50 "wcd	12,4 to 124,5 mbar	0.4 to 4.0 "wc	1,0 to 10,0 mbar	30 "Hg to 200	-1 to 13,8	400	27,6
543	10 to 200 "wcd	24,9 to 497,8 mbar	0.8 to 12 "wc	2,0 to 29,9 mbar	30 "Hg to 200	-1 to 13,8	400	27,6
544	2 to 20	0,1 to 1,4	0.2 to 2	13,8 mbar to 0,1	30 "Hg to 1200	-1 to 82,7	2500	172,4
545	5 to 50	0,3 to 3,4	0.4 to 3.2	27,6 mbar to 0,2	30 "Hg to 1200	-1 to 82,7	2500	172,4
546	10 to 125	0,7 to 8,6	0.7 to 7	48,3 mbar to 0,5	30 "Hg to 1200	-1 to 82,7	2500	172,4
547	50 to 250	3,4 to 17,2	1 to 15	0,1 to 1,0	30 "Hg to 1200	-1 to 82,7	2500	172,4
548	100 to 500	6,9 to 34,5	2 to 20	0,1 to 1,4	30 "Hg to 1200	-1 to 82,7	2500	172,4

TEMPERATURE MODEL CHART

Model	Adjustable Set Point Range		Max. Temp		Scale Division		†Stem/Bulb Size
Type B117	°F	°C	°F	°C	°F	°C	OD x Length
120	0 to 225	-17.8 to 107.2	275	135	10	5	9/16" x 1-7/8" below 1/2" NPT thread (nickel-plated brass)
121	200 to 425	93.3 to 218.3	475	246.1	10	5	9/16" x 1-7/8" below 1/2" NPT thread (nickel-plated brass)
Type E117							Bulb OD x length
2BSA	-120 to 100	-84.4 to 37.8	150	65.6	10	5	3/8 x 2-5/8"
5BS	-20 to 80	-28.9 to 26.7	130	54.4	5	2	3/8 x 5"
4BS	25 to 100	-3.9 to 37.8	150	65.6	2	1	3/8 x 6-3/4"
2BSB	30 to 250	-1.1 to 121.1	300	148.9	10	5	3/8 x 2-5/8"
3BS	100 to 400	37.8 to 204.4	450	232.2	10	5	3/8 x 2-1/8"
8BS	350 to 640	176.7 to 337.8	690	365.6	10	5	3/8 x 3-1/4"

†Optional immersion stem lengths and capillary lengths are available.



HOW TO ORDER

BUILDING A PART NUMBER

Select a **Type**

Refer to the "Type" section below.

Determine type number based on switch output, enclosure, adjustment and reference.

Fill in the type portion of your part number with the corresponding number.

Select a **Model**

Refer to the "Model Charts".

Determine model based on adjustable range, deadband and proof pressure.

Fill in the model portion of your part number with the corresponding number.

Select an **Option**

Refer to the "Options" section.

Determine option number based on switch output, optional materials or other product enhancements.

Fill in the option portion of your part number with the corresponding number.

Leave "option" portion blank if no options are needed. *FOR MULTIPLE OPTIONS:* Call United Electric Controls.

TYPE	DESCRIPTION
Pressure	Type H117 - One SPDT output; epoxy coated enclosure; internal adjustment with "High-Low" reference scale
Differential Pressure	Type H117K - One SPDT output; epoxy coated enclosure; internal adjustment with "High-Low" reference scale
Temperature	Type B117 - Immersion stem; One SPDT output; epoxy coated enclosure; internal adjustment with reference dial Type E117 - Bulb and capillary; One SPDT output; epoxy coated enclosure; internal adjustment with reference dial

SWITCH OPTIONS*

1190	Hermetically sealed, with gold flash contacts, DPDT, 11 amp 125/250 VAC; products set on rising pressure or temperature due to inherent separation of circuits on falling pressure or temperature; specify option 1195 if setting on fall is required; deadband and minimum set point will increase. NOT AVAILABLE MODELS 523, 533
1195	Hermetically sealed, with gold flash contacts, DPDT, 11 amp 125/250 VAC; products set on falling pressure or temperature due to inherent separation of circuits on rising pressure or temperature; specify option 1190 if setting on rise is required; deadband and minimum set point will increase. NOT AVAILABLE MODELS 523, 533

SENSOR AND OTHER OPTIONS

M201	Factory set one switch; specify increasing or decreasing pressure or temperature and set point
M277	Range indicated on nameplate in kPa/MPa, factory selected. NOT AVAILABLE TEMPERATURE VERSIONS
M278	Range indicated on nameplate in Kg/cm ² . NOT AVAILABLE TEMPERATURE VERSIONS
M405	Intrinsic safety compliance for European Union per ATEX standards
M406	Intrinsic safety compliance for Russia per Gosgortekhnadzor standards
M444	Paper ID tag
M446	Stainless steel ID tag & wire attachment
M449	Surface mounting hardware kit that is required for models 520-535 & 540-548 when surface mounting. Use option code only at time of ordering product, otherwise use surface and pipe mounting kit part number 6361-704 as separate order or for other models.
M504	316L stainless steel immersion stem. AVAILABLE TEMPERATURE MODELS 120, 121 ONLY
M540	Viton® construction (deadband and low end range may increase); wetted parts include Viton® diaphragm and O-ring. AVAILABLE ON MODELS 700-704 (Viton diaphragm and o-ring, stainless steel pressure connection), AND 540-548 (Viton diaphragms and seals, pressure connections remain aluminum)
M550	Oxygen service cleaning; alcohol cleaning to remove residue from the process connection. NOT AVAILABLE PRESSURE MODEL 706 OR TEMPERATURE TYPE E117
SD6286-51	Watertight conduit fitting; converts 7/8" hole to 1/2" NPT (female) fitting
6361-704	Surface and pipe mounting hardware kit for all models. Required for surface mounting models 520-535 & 540-548 if not previously ordered with option M449.

*Refer to Electrical Ratings under Specifications on page 3 for DC ratings.

OPTIONAL SENSOR MATERIAL FOR "WC RANGES. AVAILABLE MODELS 520-525

XC001	Aluminum pressure connection, Viton® diaphragm, Viton® O-ring
XC002	Aluminum pressure connection, Kapton® diaphragm, Buna N O-ring
XC003	Aluminum pressure connection, Kapton® diaphragm, Viton® O-ring
XC004	316L Stainless steel pressure connection, 316L stainless steel diaphragm, Viton® O-ring. (Over range pressure is limited to 100 psi)
XC005	316L Stainless steel pressure connection, Viton® diaphragm, Viton® O-ring
XC007	316L Stainless steel pressure connection, Teflon® diaphragm, Viton® O-ring

OPTIONAL SENSOR MATERIALS FOR CORROSIVE MEDIA. AVAILABLE MODELS 183-189, 483-489

XD002	Hastelloy® C diaphragm; NOT NACE COMPLIANT
XD003	Monel® diaphragm; NOT NACE COMPLIANT
XP112	Hastelloy® C pressure connection; NOT NACE COMPLIANT
XP113	Monel® pressure connection; NOT NACE COMPLIANT
XR211	Kalrez® O-ring
XR213	Ethylene Propylene O-ring
XR214	Aflas® O-ring

OPTIONAL FLUSH MOUNT FLANGES. AVAILABLE MODELS 565-567 ONLY

Flanges conform to ANSI B16.5. Maximum pressure is limited by flange rating.

F196	Flush mounted flange, 150#, 1" lap joint, raised face.
F198	Flush mounted flange, 300#, 1" lap joint, raised face.

OPTIONS FOR TEMPERATURE MODELS**UNION CONNECTORS** (Dimensional drawings may be found at www.ueonline.com)

Option	Replacement Number	Description
<u>Brass</u>		
W027	SD6213-27	1/2" NPT w/ 3/4" bushing
W045	SD6213-45	3/4" NPT
W051	SD6213-51	1/2" NPT
<u>304 Stainless Steel</u>		
W028	SD6213-28	1/2" NPT w/ 3/4" bushing
W046	SD6213-46	3/4" NPT
W050	SD6213-50	1/2" NPT

THERMOWELLS (Dimensional drawings may be found at www.ueonline.com)*For all bulb & capillary switches*

<u>Brass</u>		
W075	SD6225-75	1/2" NPT with 3/4" NPT adapter bushing, 4" BT
W191	SD6225-191	1/2" NPT, 4" BT
W118	SD6225-118	1/2" NPT with 3/4" NPT adapter bushing, 7" BT
W192	SD6225-192	1/2" NPT, 7" BT
<u>316 Stainless Steel</u>		
W076	SD6225-76	3/4" NPT, 4.5" BT
W193	SD6225-193	1/2" NPT, 4.5" BT
W119	SD6225-119	3/4" NPT, 7.5" BT
W177	SD6225-177	1/2" NPT, 7.5" BT

For all immersion stem switches

W139	SD6225-139	3/4" NPT X 1-23/32" BT, BRASS
W140	SD6225-140	3/4" NPT X 1-23/32" BT, 316 ST/ST

Kapton® is a registered trademark of E.I. DuPont.

OPTIONS FOR TEMPERATURE MODELS

W000 IMMERSION STEM AND THERMOWELLS

Note: Option W000 is a special Immersion Stem construction that has no external thread. This option fits inside a special thermowell and is secured with a set-screw.

Option	Description
W000	Immersion stem only, Brass
W097	Immersion stem and thermowell. Includes W000 stem and 1/2" NPT x 1-23/32" BT Brass thermowell
W099	Immersion stem and thermowell. Includes W000 stem and 1/2" NPT x 1-23/32" BT 316 st/st thermowell

OPTIONAL LENGTHS:

Optional immersion stem lengths to 15" may be available in brass, with or without 316 st/st thermowell. Consult UE for availability.

Optional capillary length to *50' may be available in copper or 304 st/st. Consult UE for availability.

Armor or Teflon® capillary protection may be available to lengths less than or equal to capillary length. Consult UE for availability.

** Consult UE regarding repeatability and ambient effects on capillary lengths over 30'.*

DIMENSIONAL DRAWINGS

Dimensional drawings for all models may be found at www.ueonline.com

Types H117, H117K, B117, E117

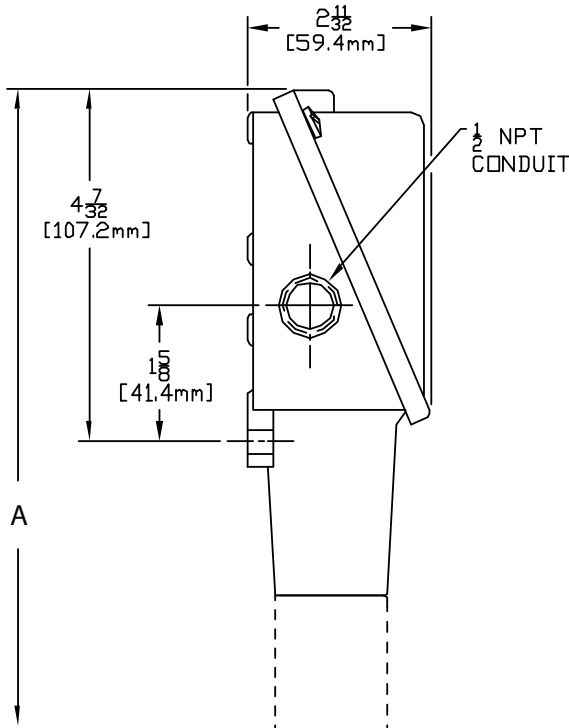

Models	Dimension A		
	Inches	mm	NPT
Pressure			
171-174	7.63	193.8	1/2"
183-186, 483-486	7.56	192.0	1/2"
188, 189, 488-489	6.63	168.4	1/2"
190-194, 490-494	6.63	168.4	1/2"
218	6.56	166.6	1/4"
358-376	7.00	177.8	1/4"
520-525	8.44	214.4	1/2"
530-535	8.00	203.2	1/2"
565-567	6.63	168.4	1-1/2" Flush Mount
700-706	6.63	168.4	1/4"
Differential Pressure			
540-543	8.47	215.1	1/8"
544-548	8.53	216.7	1/8"
Temperature			
120,121	9.38	238.3	Immersion Stem
2BSA-8BS	8.69	220.7	Bulb & Capillary

Types H117, H117K

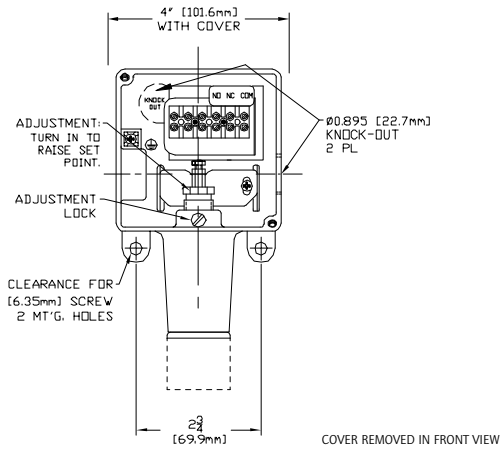

Types B117, E117

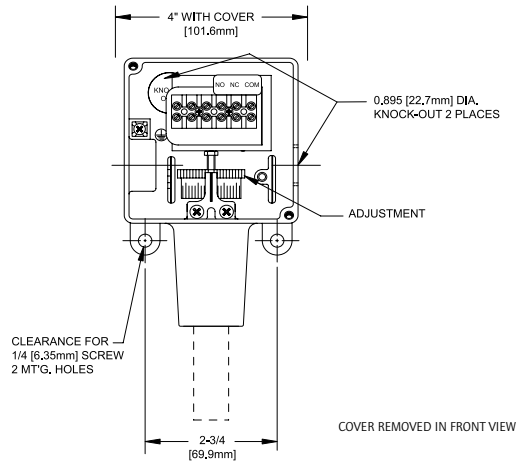

PRESSURE SENSORS

Models 171-174

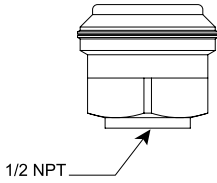

Models 183-186, 483-486

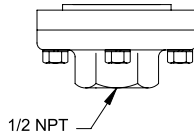

Models 188-194, 488-494

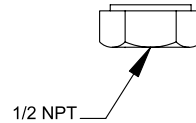

Models 218-376, 700-706

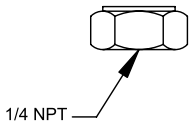

Models 520-525

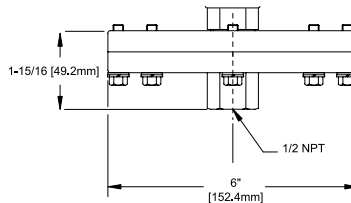

Models 530-535

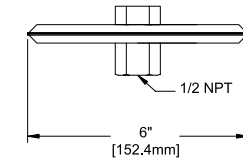

Models 565-567

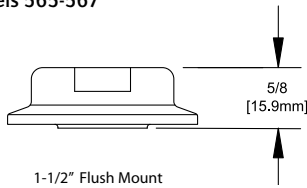

DIFFERENTIAL PRESSURE SENSORS

Models 540-543

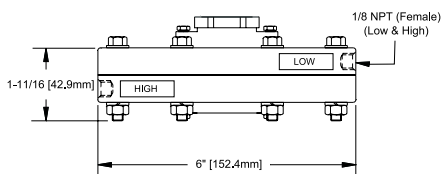

Models 544-548

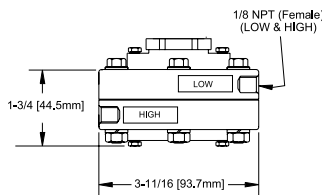

TEMPERATURE SENSORS

Model 2BSA-8BS

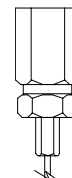

Model 120-121

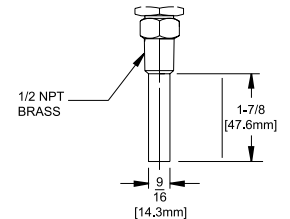

RECOMMENDED PRACTICES AND WARNINGS

United Electric Controls Company recommends careful consideration of the following factors when specifying and installing UE pressure and temperature units. Before installing a unit, the Installation and Maintenance instructions provided with unit must be read and understood.

- To avoid damaging unit, proof pressure and maximum temperature limits stated in literature and on nameplates must never be exceeded, even by surges in the system. Operation of the unit up to maximum pressure or temperature is acceptable on a limited basis (e.g., start-up, testing) but continuous operation must be restricted to the designated over range pressure. Excessive cycling at maximum pressure or temperature limits could reduce sensor life.
- A back-up unit is necessary for applications where damage to a primary unit could endanger life, limb or property. A high or low limit switch is necessary for applications where a dangerous runaway condition could result.
- The adjustable range must be selected so that incorrect, inadvertent or malicious setting at any range point cannot result in an unsafe system condition.
- Install unit where shock, vibration and ambient temperature fluctuations will not damage unit or affect operation. When applicable, orient unit so that moisture does not enter the enclosure via the electrical connection. When appropriate, this entry point should be sealed to prevent moisture entry.
- Unit must not be altered or modified after shipment. Consult UE if modification is necessary.
- Monitor operation to observe warning signs of possible damage to unit, such as drift in set point or faulty display. Check unit immediately.
- Preventative maintenance and periodic testing is necessary for critical applications where damage could endanger property or personnel.
- Electrical ratings stated in literature and on nameplate must not be exceeded. Overload on a switch can cause damage, even on the first cycle. Wire unit according to local and national electrical codes, using wire size recommended in installation sheet.
- Do not mount unit in ambient temp. exceeding published limits.

LIMITED WARRANTY

Seller warrants that the product hereby purchased is, upon delivery, free from defects in material and workmanship and that any such product which is found to be defective in such workmanship or material will be repaired or replaced by Seller (Ex-works, Factory, Watertown, Massachusetts. INCOTERMS); provided, however, that this warranty applies only to equipment found to be so defective within a period of 24 months from the date of manufacture by the Seller. Seller shall not be obligated under this warranty for alleged defects which examination discloses are due to tampering, misuse, neglect, improper storage, and in any case where products are disassembled by anyone other than authorized Seller's representatives. EXCEPT FOR THE LIMITED WARRANTY OF REPAIR AND REPLACEMENT STATED ABOVE, SELLER DISCLAIMS ALL WARRANTIES WHATSOEVER WITH RESPECT TO THE PRODUCT, INCLUDING ALL IMPLIED WARRANTIES OF MERCHANTABILITY OR FITNESS FOR ANY PARTICULAR PURPOSE.

LIMITATION OF SELLER'S LIABILITY

SELLER'S LIABILITY TO BUYER FOR ANY LOSS OR CLAIM, INCLUDING LIABILITY INCURRED IN CONNECTION WITH (I) BREACH OF ANY WARRANTY WHATSOEVER, EXPRESSED OR IMPLIED, (II) A BREACH OF CONTRACT, (III) A NEGLIGENT ACT OR ACTS (OR NEGLIGENT FAILURE TO ACT) COMMITTED BY SELLER, OR (IV) AN ACT FOR WHICH STRICT LIABILITY WILL BE INPUTTED TO SELLER, IS LIMITED TO THE "LIMITED WARRANTY" OF REPAIR AND/OR REPLACEMENT AS SO STATED IN OUR WARRANTY OF PRODUCT. IN NO EVENT SHALL THE SELLER BE LIABLE FOR ANY SPECIAL, INDIRECT, CONSEQUENTIAL OR OTHER DAMAGES OF A LIKE GENERAL NATURE, INCLUDING, WITHOUT LIMITATION, LOSS OF PROFITS OR PRODUCTION, OR LOSS OR EXPENSES OF ANY NATURE INCURRED BY THE BUYER OR ANY THIRD PARTY.

UE specifications subject to change without notice.

U.S. SALES OFFICES

United Electric Controls
31 Old Stage Road
Hampton Falls, NH 03844
Phone: 617-899-1132
email: northeastsales@ueonline.com

United Electric Controls
28 N. Wise Ave.
Freeport, IL 61032
Phone: 815-341-2588
email: midwestsales@ueonline.com

United Electric Controls
1022 Vineyard Drive
Conyers, GA 30013
Phone: 770-335-9802
email: southeastsales@ueonline.com

United Electric Controls
5829 Grazing Court
Mason, OH 45040
Phone: 513-535-5486
email: midatlanticsales@ueonline.com

United Electric Controls
102 Salazar Court
Clayton, CA 94517
Phone: 925-408-5997
email: westcoastsales@ueonline.com

United Electric Controls
27 Summit Terrace
Sparta, NJ 07871
Phone: 973-271-2550
email: easternsales@ueonline.com

United Electric Controls
33018 Weatherby Court
Fulshear, Texas 77441
Phone: 832-457-6138
email: southwestsales@ueonline.com

CANADA

EASTERN
68 Mosley Crescent
Brampton, Ontario
Canada L6Y 5C8
Phone: 905-455-5131
FAX: 905-455-5131

INTERNATIONAL OFFICES

CHINA

United Electric Controls, *Shanghai Office*
Room 1011, 10th Flr,
Huai Hai Zhonghua Building
No. 885, Renmin Road, Luwan District
Shanghai 200010, P.R. China
Phone: +8621-6255 8059
email: chinasales@ueonline.com

United Electric Controls, *Beijing Office*
Room 1006, Jainhao International Bldg.
Block D, No. 116
Zizhuyuanlu, Haidian District
Beijing, China 100089
Phone & Fax: +86-10-5893-0551
email: beijingsales@ueonline.com

EUROPE

United Electric Controls
05-806 Komorow
Kujawska 5, Poland
Phone: +48 22 499 4804
email: europesales@ueonline.com

INDIA

United Electric
#402, Aries Avenue - 1
United Colony, Sama, Baroda
Baroda (Gujarat), India
Phone: +91 (-265) -2788654
email: indiasales@ueonline.com

ASIA-PACIFIC

United Electric Controls, Far East
No. 1-2-2, 2nd Floor
Jalan 4/101C
Cheras Business Centre
56100 Kuala Lumpur, Malaysia
Phone: 603-9133-4122
email: asiapacific@ueonline.com

MEXICO

United Electric Controls
Privada Fernando San Pedro 305
Col El Naranjal 89349
Tampico, Tamaulipas Mexico
Phone: +52 833-116-7637
email: latinamericasales@ueonline.com

RUSSIA & SCANDINAVIA

United Electric Controls, Moscow
Elninskaya str., 15-140
Moscow, 121552 Russia
Phone: +7 (495) 792-88-06
email: russiansales@ueonline.com



UNITED ELECTRIC
CONTROLS

180 Dexter Avenue, P.O. Box 9143
Watertown, MA 02471-9143 USA
Telephone: 617 926-1000 Fax: 617 926-2568
<http://www.ueonline.com>