



# KFR-1050 Series Automatic Screw Feeder

## Operation Manual



Before operating the unit, please read this manual thoroughly, and retain it for future reference.

**Patent reserved in China, Taiwan, Japan & Korea.  
Imitation of product will lead to prosecution.**





## SAFETY INSTRUCTIONS

### PLEASE NOTE FOLLOWING CONDITIONS BEFORE USING KILEWS KFR-1050:

- ⊙ For a normal performance, please install this machine on a flat and stable working table, do not slant or pad, otherwise machine function might be affected.
- ⊙ Turn off the power switch and unplug the AC adaptor when this machine is not being used for a period of time.
- ⊙ To avoid damage and malfunction, use the AC adaptor supplied with this machine only.
- ⊙ Keep the surface of the rail groove clean and free from dust or oil. Failure to keep the rail groove clean could result in damage to the machine.
- ⊙ The applied screws must be clean without grease or dust, and screw size is within specified range as machine rail.
- ⊙ Handle screws on Rails with care, do not use excess force to remove them or the Rails may be damaged.
- ⊙ When Scooping Chamber is turning, do not put fingers or objects other than screws into the Chamber.
- ⊙ Do not turn ON the Power Switch before the Rails are set properly for operation.
- ⊙ In case of malfunction during operation, please turn off the power and unplug the AC adaptor. Contact your supplier at once.

**Whenever this machine requires service, please contact your supplier for assistance, or go to our website & e-mail us your contact detail and requirement, we will respond ASAP.**



## CONTENTS

|  |           |
|--|-----------|
| <b>CHECKING BEFORE OPERATING</b>                         | <b>3</b>  |
| ACCESSORIES.....   | 3         |
| CHECK THE SCREW SIZE.....                                | 3         |
| <b>ADJUSTING &amp; CHANGING BEFORE OPERATING</b>         | <b>4</b>  |
| CHANGE THE STOPPER.....                                  | 4         |
| ADJUST THE RAIL ASSEMBLY.....                            | 7         |
| CHANGE THE RAIL ASSEMBLY.....                            | 11        |
| ADJUST THE VOLTAGE OF BIT GUIDE SENSOR.....              | 13        |
| ADJUST V CHASE ON SCOOPING CHAMBER BACK.....             | 16        |
| ADJUST THE BRUSH.....                                    | 17        |
| ADJUST THE POSITION OF HOLDING PLATE.....                | 19        |
| ADJUST BIT GUIDE POSITION.....                           | 20        |
| ADJUST THE BIT GUIDE BRACKET1.....                       | 21        |
| <b>OPERATING METHOD</b>                                  | <b>22</b> |
| LOAD SCREWS INTO CHAMBER.....                            | 22        |
| PICKING UP SCREW.....                                    | 23        |
| <b>FUNCTIONS WITH ADJUSTING HOLES ON HOUSING AND PCB</b> | <b>24</b> |
| <b>MAINTENANCE &amp; TROUBLE SHOOTING</b>                | <b>25</b> |
| <b>MAINTENANCE &amp; CLEANING</b>                        | <b>27</b> |
| <b>INTERNATIONAL WARRANTY CONDITIONS</b>                 | <b>28</b> |
| <b>WARRANTY CARD</b>                                     | <b>33</b> |



## CHECKING BEFORE OPERATING

### ACCESSORIES :

**PLEASE CHECK THE FOLLOWING ACCESSORIES INCLUDED BEFORE USING KILEWS KFR-1050.**

Allen Key 2.0 \* 108mm L- type \* 1



AC ADAPTOR (AC 100~240V / DC15V) \* 1

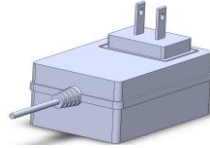

STOPPER (K10150) for screw  
dia. 2.0~5.0 mm x 1  
dia. 1.0~2.0 mm x 1



Operation Manual x 1

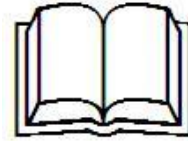

Accessory - Tooling Plate (behind):  
20 \* 10 \* 0.2mm x 2 pcs & 0.5mm x 10 pcs

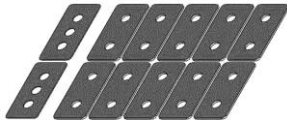

Accessory-Tooling Plate (front) ;70 \* 19 \*  
0.8mm , 1.0mm , 1.2mm , 1.5mm , 2.0mm  
x 1pc each.



### CHECK THE SCREW SIZE :

Measure the size precisely on each part of applied screw with a caliper. This machine is easy to adjust rail groove to meet various diameter of applied screws length within 19mm under the screw head(c) .

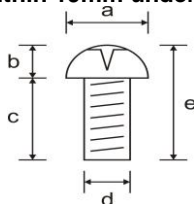

|   |                      |
|---|----------------------|
| a | Dia. Of screw head.  |
| b | Height of Screw Head |
| c | Screw Length         |
| d | Dia. Of screw bolt.  |
| e | Screw total Length   |



## ADJUSTMENT & CHANGES BEFORE OPERATING

### CHANGE THE STOPPER

Select the correct stopper according to the size of the screws. This machine is pre-set with rail width 1.4mm, with small stopper (K10140) for flat screw of dia. 1.0~2.0mm. For bigger screw of (d) dia. 2.0~5.0 mm please take out the big stopper (K10150) from the top cover box, and change the stopper as following:

1. Facing the machine, use 2.0 mm Allen Key (accessory) to loosen the screw in the LOCK GATE (between UP-DOWN) on the top of the front Housing plate.

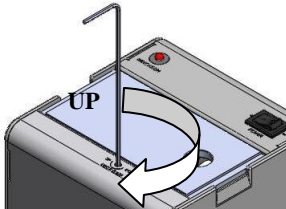

2. Using same method to loosen the screw in the Lock Gate (between UP-DOWN) at the right hand side of the Housing plate.

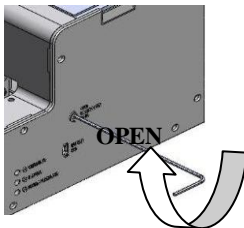

3. Loosen the Rail fixing (hex bolt) screw in the left hand corner of the Bit Guide Assembly, and then withdraw the Rail Assembly from the front of the machine.

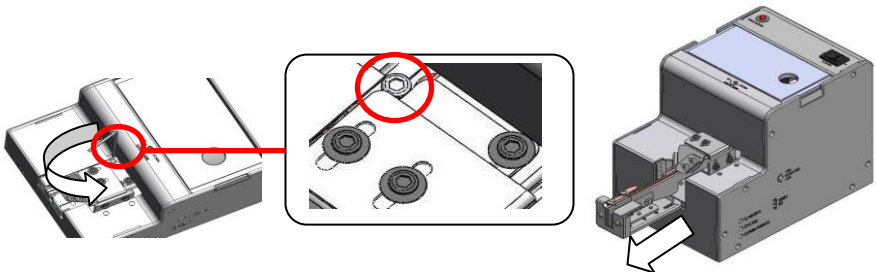



4. Move the Stopper Spring Plate (K07400), from above to below the stopper.

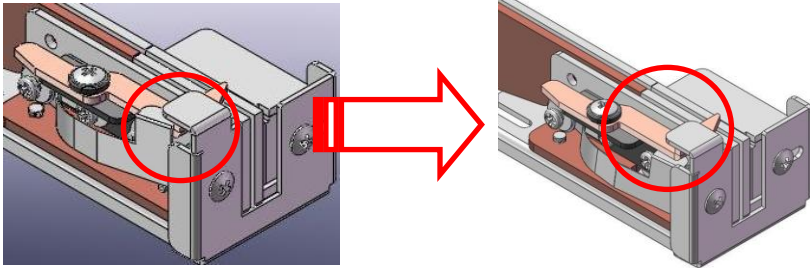

5. Loosen the Stopper (Truss Head) Screw CH20504-5, and change the Stopper as required. Secure the Stopper by tightening the screw, and place the Stopper Spring Plate on top of the Stopper.

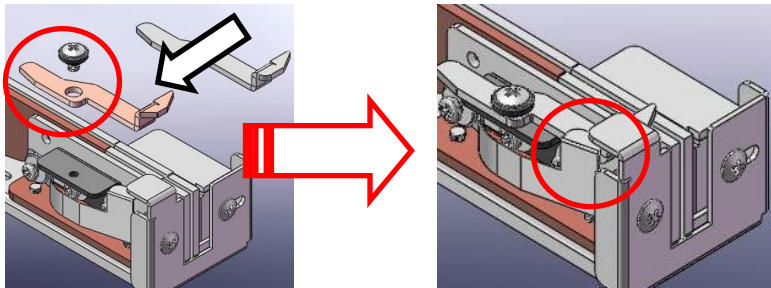

6. After the Stopper is changed, plug Rail Assembly into the unit. Push it until reaching the pillar end, and be sure that the bottom of Rail Front Cover has clipped the plate edge of Sensor Supporter Plate. Tighten the screw (of step3) after Rail Assembly is placed in position.

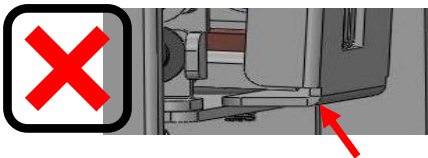
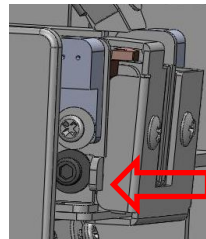
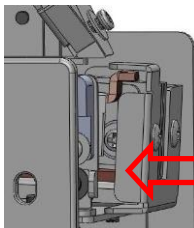



7. When tightening 2 screws in Lock Gates (of step 1 & step 2), do not tighten completely, leave a 0.2~0.3mm open space between Passage Plate and Holding Plate on top; and also leave 0.2~0.3mm width to the right of the Rail Plate.

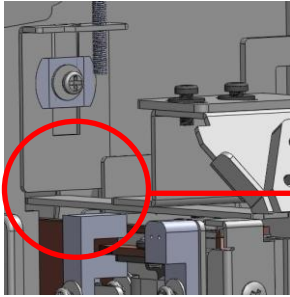

### ※ NOTES FOR CHANGING THE STOPPER ※

- a. The tip of Stopper must be positioned at the high low point on Rail top, keep Stopper tip laying on the rail top, and be movable smoothly at the low surface on rail top.

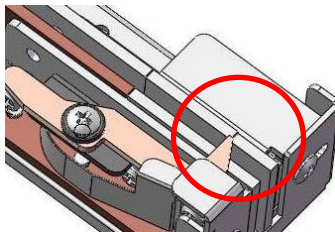

- b. When Rail Assembly is placed into the machine, adjust the Rail Front Cover to be placed in the center with equal distances on both sides to the Front Cover, and fix by tightening the screws

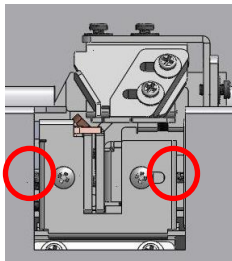

Keep equal distance on both sides.





## ADJUSTMENT & CHANGES BEFORE OPERATING

### ADJUST THE RAIL ASSEMBLY

1. Facing the machine, use 2.0 mm Allen Key (accessory) to loosen the screw in the LOCK GATE hole (between UP-DOWN) on top of the front Housing Plate.

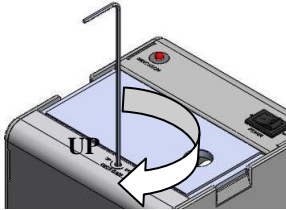

2. Same to loosen the screw in the Lock Gate hole (between UP-DOWN) at right side Housing plate.

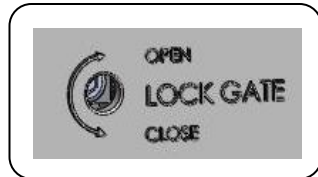
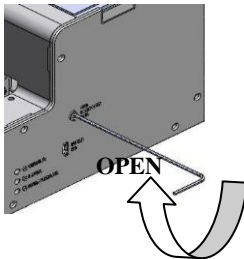

3. Loosen the Rail fixing (hex bolt) screw in the corner at left back of Bit Guide Assembly, then draw out the Rail Assembly at front of this machine.

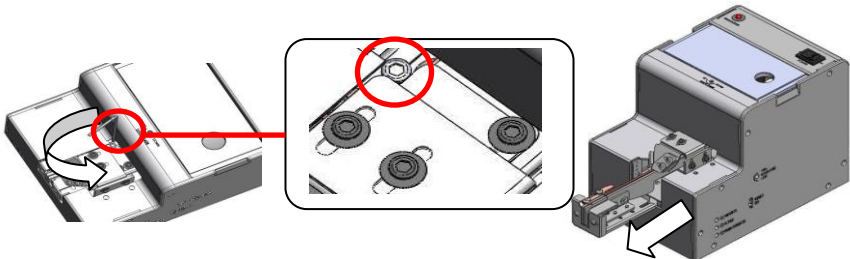



4. Use Allen Key to loosen the screw at right side of Rail Front Cover.

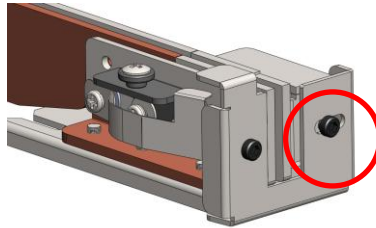

5. Turn the Rail Assembly upside down to find 3 screws placed in long-circular holes. And loosen these 3 screws.

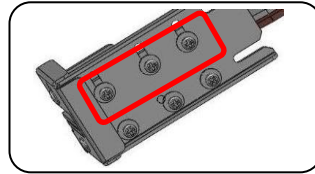
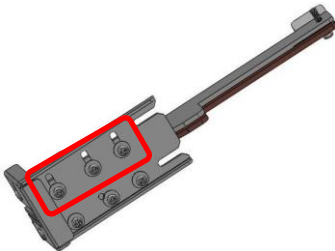

6. Loosen the screw fastening the Tooling Plates at the rear end of Rail Assembly, take out the screw and the Tooling Plate.

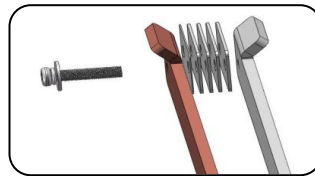
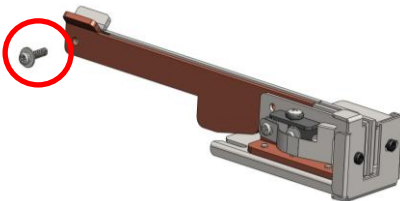

7. Refer to the following table, select the Front Tooling Plate (0.8mm, 1.0mm, 1.2mm, 1.5mm, 2.0mm) and insert it into the front Rail Groove for the width required and tighten the screws in the long-circular holes (reverse of step 4 & 5).

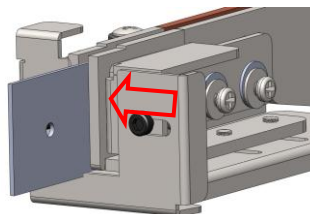
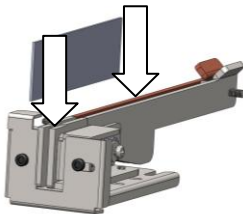



**※ COMBINATION OF THE THICKNESS FOR REFERENCE ※ Table A**

| Dia. Of screw bolt (d).mm | Accessory-Tooling Plate (FRONT) mm | Dia. Of screw bolt (d).mm | Accessory-Tooling Plate (FRONT) mm |
|---------------------------|------------------------------------|---------------------------|------------------------------------|
| 0.8                       | 0.1 + 0.8                          | 2.3                       | 1.0+1.5                            |
| 1.0                       | 1.2                                | 2.6                       | 1.2+1.5                            |
| 1.2                       | 0.1 + 1.2                          | 3.0                       | 1.2+2.0                            |
| 1.4                       | 1.5                                | 3.5                       | 1.0+1.2+1.5                        |
| 1.7                       | 0.8+1.0                            | 4.0                       | 1.0+1.2+2.0                        |
| 2.0                       | 1.0+1.2                            | 5.0                       | 0.8+1.0+1.5+2.0                    |

8. Refer to the following table, select the Tooling Plate BEHIND (0.8mm, 1.0mm, 1.2mm, 1.5mm, 2.0mm), to insert it into the rear end of Rail Groove for the width required and tighten the screws (of step 6).

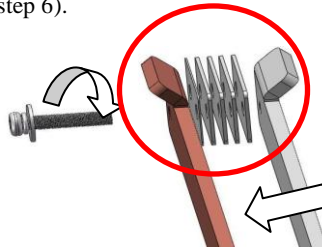

**※ COMBINATION OF THE THICKNESS FOR REFERENCE ※ Table B**

| Dia. Of screw bolt (d).mm. | Accessory-Tooling Plate (REAR)mm | Dia. Of screw bolt (d).mm | Accessory-Tooling Plate (REAR)mm |
|----------------------------|----------------------------------|---------------------------|----------------------------------|
| 0.8                        | $0.2 * 2 + 0.5 = 0.9$            | 2.3                       | $0.2 * 2 + 0.5 * 4 = 2.4$        |
| 1.0                        | $0.2 + 0.5 * 2 = 1.2$            | 2.6                       | $0.2 + 0.5 * 5 = 2.7$            |
| 1.2                        | $0.2 * 2 + 0.5 * 2 = 1.4$        | 3.0                       | $0.2 + 0.5 * 6 = 3.2$            |
| 1.4                        | $0.5 * 3 = 1.5$                  | 3.5                       | $0.2 + 0.5 * 7 = 3.7$            |
| 1.7                        | $0.2 * 2 + 0.5 * 3 = 1.9$        | 4.0                       | $0.2 + 0.5 * 8 = 4.2$            |
| 2.0                        | $0.2 + 0.5 * 4 = 2.2$            | 5.0                       | $0.2 + 0.5 * 10 = 5.2$           |

9. After the width adjustment of the Rail Assembly, place a screw into the Groove and slide it up and down to both ends, to check whether the movement is smooth.

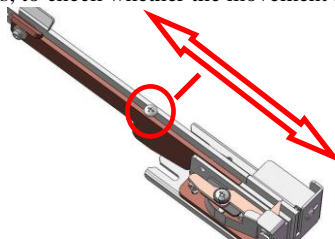



10. After Rail Assembly is adjusted, put Rail Assembly back to the unit. Push it until reaching the pillar end, and make sure that the bottom of the Rail Front Cover has clipped into the edge of Sensor Supporter Plate.

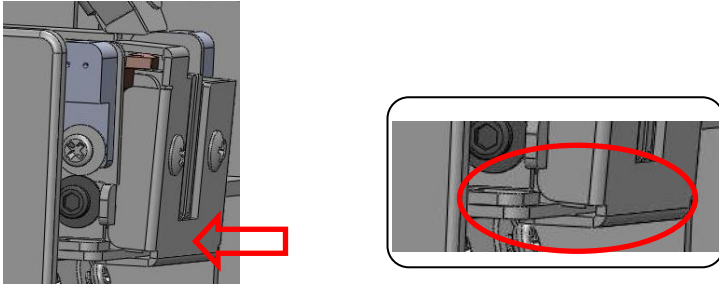

11. When tightening 2 screws in Lock Gates (on top & right), do keep 0.2~0.3mm open space between Passage Plate to top & right side.



0.2mm~0.3mm

※ NOTE THE FOLLOWINGS WHEN MAKING ABOVE ADJUSTMENT ※

- The width at rear Rail Groove can be adjusted wider than the front, but never make the width at front section become wider than middle or rear section.
- To adjust the width at front Rail Groove as close as the diameter of screws, and the screw can come through it.
- For screw type  $a=c$  or  $a>c$ ; the width at front Rail Groove must be adjusted wider than the rear, and the width at rear Rail Groove must be larger than the screw length( $e$ ).
- 3 screws of step 5 must be tightened firmly before putting the Rail Assembly into the machine.



## ADJUSTMENT & CHANGES BEFORE OPERATING

### CHANGE THE RAIL ASSEMBLY

1. Facing the machine, use 2.0 mm Allen Key (accessory) to loosen the screw in the LOCK GATE hole (between UP-DOWN) on top of front Housing plate.

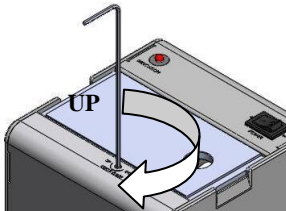

2. Same to loosen the screw in the Lock Gate hole (between UP-DOWN) at right side Housing plate.

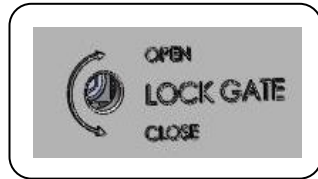
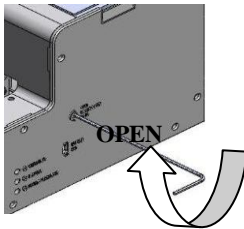

3. Loosen the Rail fixing (hex bolt) screw in the corner at left back of Bit Guide Assembly, then draw out the Rail Assembly at front of this machine.

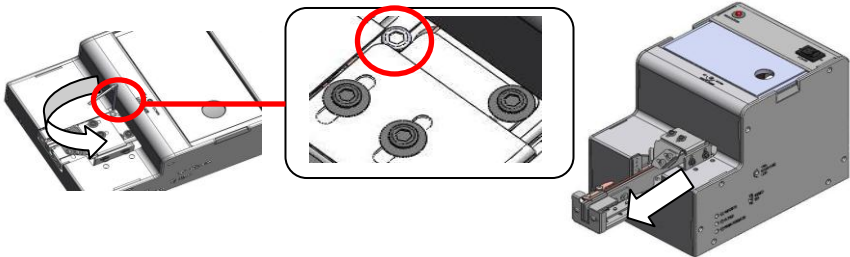



4. Replace new Rail Assembly into the unit. Push it until reaching the pillar end, and be sure that the bottom of Rail Front Cover has clipped into the plate edge of Sensor Supporter Plate. Tighten the screw after Rail Assembly is placed in proper position.

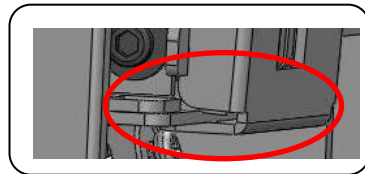
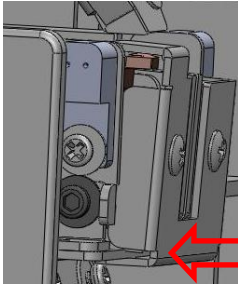

P.S. See ADJUST THE RAIL ASSEMBLY steps to adjust new Rail Assembly

※ NOTE THE FOLLOWINGS WHEN MAKING ABOVE ADJUSTMENT ※

- a. Fitting must be smooth with no obstruction. When the Rail Assembly is parallel, push it into the machine. Examine the assembly if any obstruction caused.



## ADJUSTMENT & CHANGES BEFORE OPERATING

### ADJUST THE VOLTAGE OF BIT GUIDE SENSOR

Basically this is only required when the Rail Assembly has been replaced. It's not necessary to adjust the sensor voltage level whenever the Rail Assembly is merely changed on width. When screws are stopped on the rails, and the LED on PCB is ON, please adjust the sensor voltage as following:

1. Remove the screws of front Housing (3 pcs each side), and take off the front Housing.

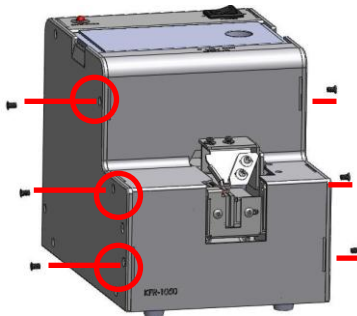

2. Either take off the Bit Guide-Plate or loosen the screws on it to clear the top of Stopper.

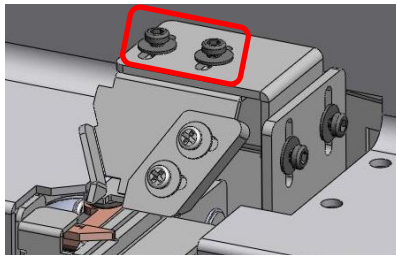



3. Facing the unit and find a resistor pin marked PT1 at the left upper corner of PCB, and clip it with red (+) rod of DCV meter and clip the black (-) rod at the metal portion at machine bottom.

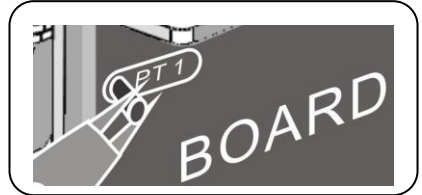
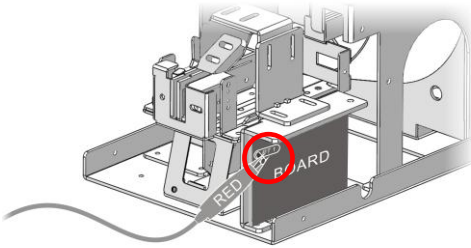

4. Turn ON the machine switch and you can read a value on DCV meter.
5. This value indicates whether a screw is loaded at Stopper position. When no screw is loaded at Stopper position, value reads 0.25V~0.4V  
If the value is not as specified above, you need to adjust the position of Bit Guide sensor as following.
6. Facing the unit and find the Bit Guide Sensor with green & black wires at left Rail Assembly. Loosen the black screw (with Hex socket cap) below it will make the Sensor unit become movable to adjust its position.

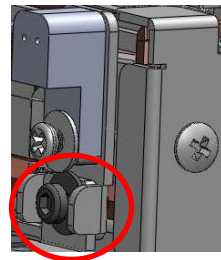
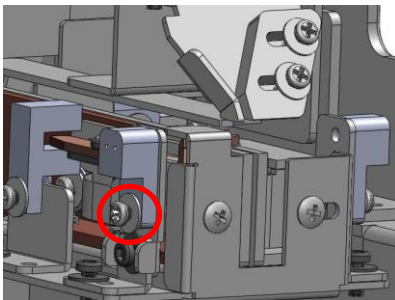





7. Adjust the Sensor unit to a proper position to enable the DCV meter check value read between +0.25~0.4V, than tighten the screw to fix it.

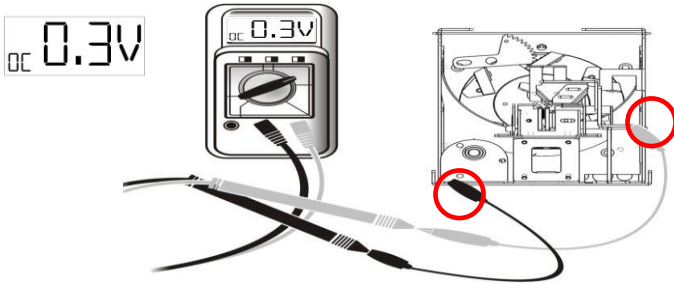

8. After the adjustment of the Sensor unit, you need to check and adjust the Bit Guide Assembly back to the height level, position as required.

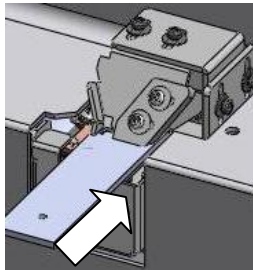

**※ NOTE THE FOLLOWINGS WHEN MAKING ABOVE ADJUSTMENT ※**

- This machine is manufactured with setting: Sensor voltage level between 0.25~0.4DCV and the width of the Rail Groove at 1.4mm.
- It takes more time to adjust machine for screws with thin head height (b) 0.2~0.5mm; please contact your supplier when assistance is required.



## ADJUSTMENT & CHANGES BEFORE OPERATING

### ADJUST V CHASE ON SCOOPING CHAMBER BACK

The V Chase at the back of Roller Assembly is for catching screws scooped and drop from Rollers. The caught screws slip into the Rail's V end and guided into the rail groove successively.

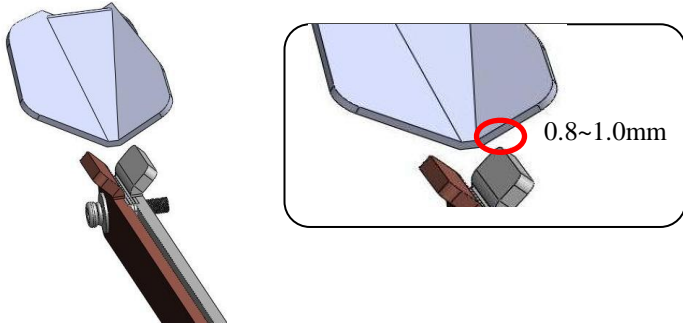

There are 2 Hex socket screws in the long-circular hole of rear cover. Use attached Allen Key to loosen 2 screws for adjusting the V Chase to be positioned to aim at the top of Rail's V end, and tighten screws to fix it.

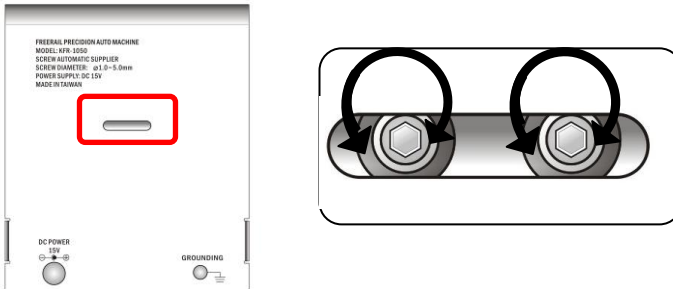

### ※ CAUTION FOR ABOVE ADJUSTING ※

- Keep V Chase over the Rails' V end for 0.8~1.0 mm distance.
- Keep V Chase apart from the Rail Assembly to avoid vibration and noise occurring.
- When the Rail Assembly will not push to end, please check whether V Chase is adjusted too low to affect it.



## ADJUSTING & CHANGING BEFORE OPERATING

### ADJUST THE BRUSH

1. Facing the unit, swing the Brush to stay almost horizontal (about 85~90 degree to Rail Assembly)

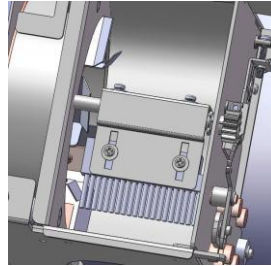

2. Place 5~8 screws in the rail groove close to the Holding Plate. Loosen 2 screws on the side of the Brush Bracket, swing the Brush down and adjust the height so the brush just touch the screw heads slightly, and tighten the screw after adjustment. When making the position adjustment, please do not swing the Brush exceeding the range allowed.

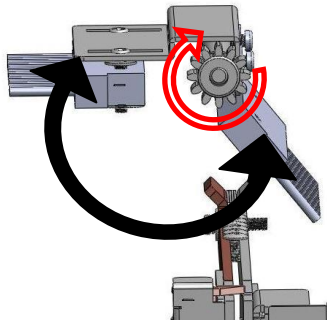

3. When fix the Brush position, keep 0.2~0.5 mm distance between Brush and Front Plate.

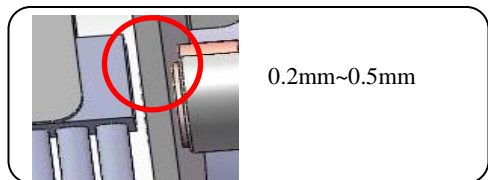
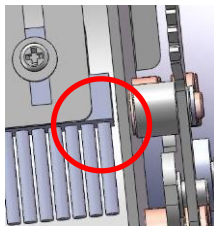



4. When fixing the Brush Bracket onto the Brush Driving Shaft, keep both parts parallel and lock screws in center of the long-circular holes

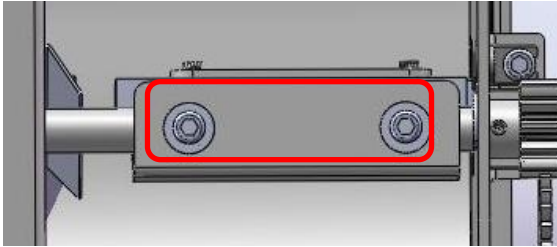

**※ CAUTION FOR THE ABOVE ADJUSTING ※**

- a. The height of the Brush is produced in accordance with same height level of Rail Assembly, so the adjustment is to keep the Brush Bracket in alignment with the Brush Driving Shaft.
- b. Adjustment of the height of the Brush is to make the Brush just slightly in touch with screw heads, which sweeps down improper screws out of rail groove and does not affect the movement of Brush sweeping.
- c. After the screws are fixed, swing the Brush by hand to make sure no obstacles are against it.



## ADJUSTMENT & CHANGES BEFORE OPERATING

### ADJUST THE POSITION OF HOLDING PLATE.

1. Place 5–8 screws in the rail groove close to Holding Plate. Loosen 2 screws on left Bit Guide Bracket (see fig.).

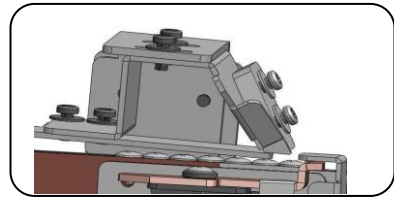
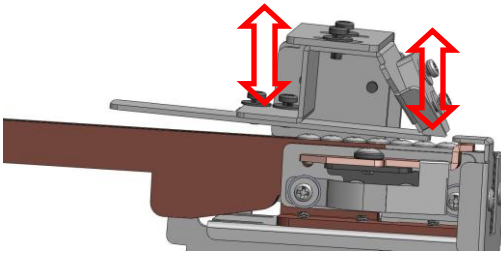
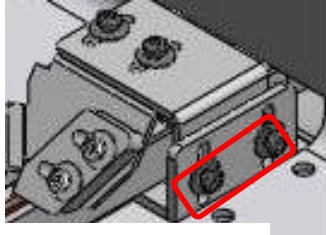

2. According to the measured size (see P.2) on screw head (b), select the tooling plates (Accessory-front) in Top Cover Box and combine them to achieve the thickness required (ex. Height of Screw Head 3.0mm = Tooling Plates 2.0mm + 1.2mm) Insert the selected tooling plate(s) in between Bit Guide & Rail Assembly, and tighten 2 screws (of step.1) on left Bit Guide Bracket.

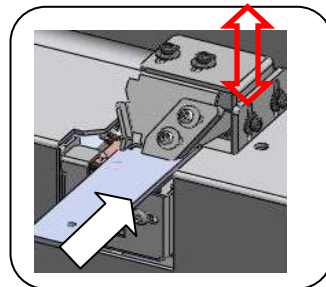
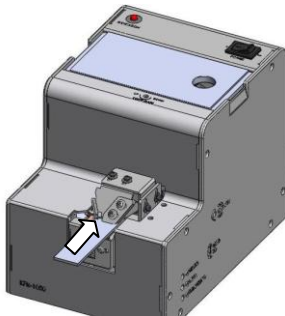



## ADJUSTING & CHANGING BEFORE OPERATING

### ADJUST BIT GUIDE POSITION

1. Place 5~8 screws in the rail groove, and lean to the front with first screw stay in position by Stopper tip.
2. Loosen 2 screws on top of Bit Guide-Plate (see fig.) enable Bit Guide-Plate be adjusted forward or backward subject to position of the screw head. Tighten the screws after adjustment.

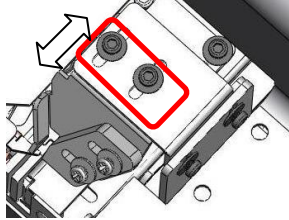

3. Loosen 2 screws in 2 holes at right top of Front Cover, enable Bit Guide-Plate be adjusted to right or left side subject to position of the screw head. If the size of screw head is not matching the space for Bit to pick up, adjust the Bit Guide Bracket (1) as step 4. Tighten the screws after adjustment.

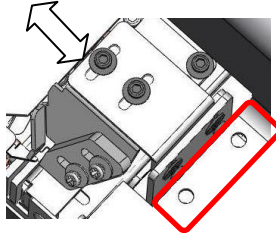

4. Before tighten the screw of step3, loosen 2 screws on Bit Guide Bracket 1, and enlarge or reduce the space for matching the size of screw head, and tighten the screws after the adjustment.

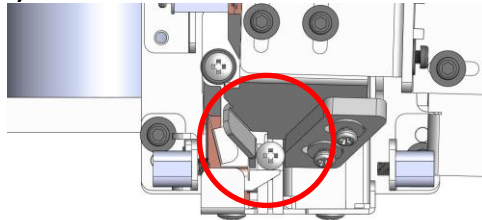

### ※ CAUTION FOR THE ABOVE ADJUSTING ※

The Holding Plate and Bit Guide-Plate are always vertical jointed firmly without extra edge.



## ADJUSTMENT & CHANGES BEFORE OPERATING

### ADJUST THE BIT GUIDE BRACKET 1

1. Bit Guide Bracket 1 is a trapezoid iron plate on right side of Bit Guide. Loosen 2 screws on 1 with Bit Guide-Plate adjusted to left or right make the operating space of the Bit Guide to match the size of screw head required. Tighten the screws after adjustment.

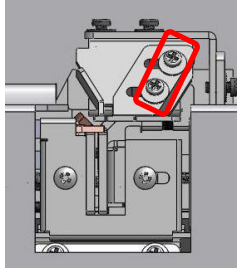

2. Use an applied screwdriver to test if all spaces are adjusted correctly with the screw feeding and pick up.

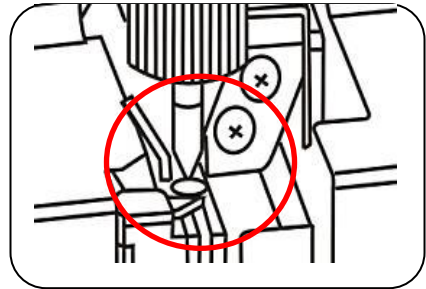
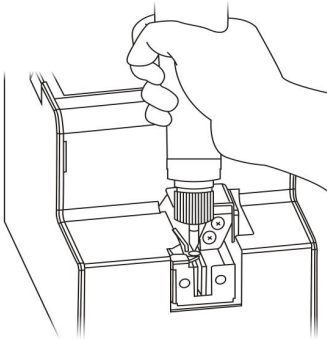

### ※ CAUTION FOR THE ABOVE ADJUSTING ※

- a. Adjusting the gap between Bit Guide-Plate and Bracket 1 to comply with the size of the screw head.
- b. When adjust Bit Guide Bracket 1 to left or right, move it horizontally and joint with Guide-Plate closely.
- c. Adjust the space of Bit Guide big enough to cover whole screw head, enable screwdriver bit to pick screw up punctually, and the screw head is located in the center of that space.



## OPERATING METHOD

After completing the required checks & adjustments as mentioned above, start to operate KILEWS KFR-1050 Automatic Screw Feeder in following order:

1. Make sure the AC adaptor is the original one supplied with the machine.
2. Lock Gates are closed with a required opening gap on top and right hand sides.
3. Make sure that Rail Assembly has totally pushed back to the end, and the bottom of the Rail Front Cover has clip on the Sensor Supporter Plate.

## LOAD SCREWS INTO CHAMBER

Turn off the power first, and open the Top Cover Box. Ensure that screws are loaded without foreign materials. Pour in screws until they come up to 1~2 mm below the top on both sides of the rails.

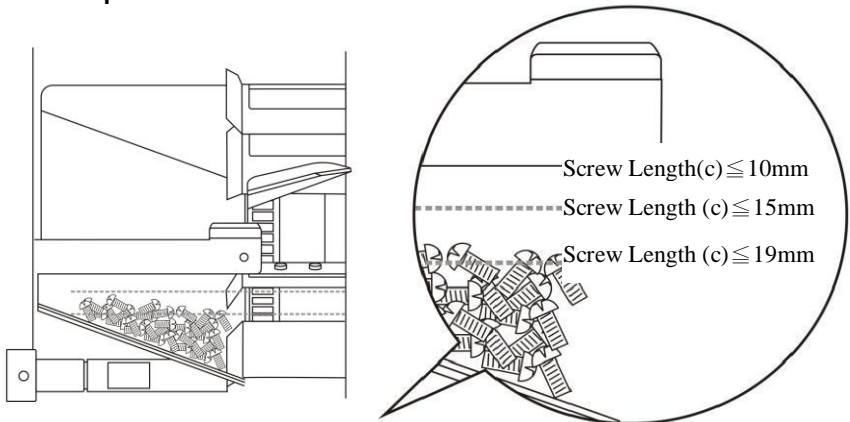

The amount of screw is about 200~220cc. All objects other than applied screw are deemed as foreign material which should be removed first; or it will affect the performance of this machine.

## TURN ON THE POWER

Plug in the AC adaptor supplied with the machine to the electric outlet first, and then plug the L shape DC connector into the other DC jack at the rear of the machine.

Turn on the POWER switch at rear, on the top right side of the Screw Chamber, then the indicator will light on, the Roller runs to scoop and Rails begin vibrating. Machine starts to work.





## PICKING UP SCREW

Make sure the bit type on your electric screwdriver matches the head of the screw, and the bit is magnetized before use. (Bit that not magnetized will not stick with the screw and screw will fall off after picking up). Hold the screwdriver and put the driver bit above the Bit Guide and push it straight down to "+" on top of the screw as figure below.

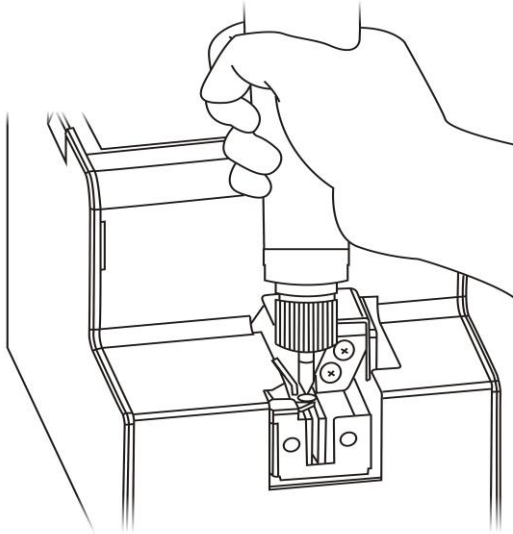

### ※ CAUTION FOR THE ABOVE OPERATING ※

- a. Do not push the driver bit with too much force when picking up the screw, or it will damage the Rail Assembly.
- b. Do not deliberately apply force on the Rail Assembly, or it will damage the machine.



## FUNCTIONS WITH ADJUSTING HOLES ON HOUSING AND PCB

Facing the machine, there are some controls on the right hand side of the Housing and the back with following functions:

- Vibration Timer – To set vibration time from a screw reached Bit Guide section until the vibration stops.
- Roller Timer – To set the time of Roller from a screw reached Bit Guide section until the vibration stops.
- Swing Strength – To adjust the strength of vibration. **Do not adjust it as calibration is done prior leaving factory.**

To avoid damaging the “+” mark on VR caps, do not adjust with improper tool or over tighten. All the time setting starts from the screw arrives at the Bit Guide (Stopper) position. See adjustment indication on the Housing Plate to adjust the time as user’s peration preference.

- Lock Gate Plate – To adjust the required gap base on the size and type of screws.
- Indication Light – The LED will light when PCB overloading protection started.
- Grounding Hole – For the earth line to PCB & bottom Housing.
- DC Power Jack – For input required DCV from AC adaptor.
- Power S.W. - Power Switch to turn ON/OFF.

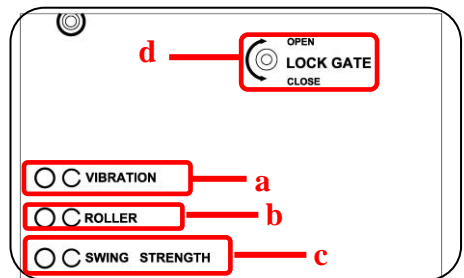
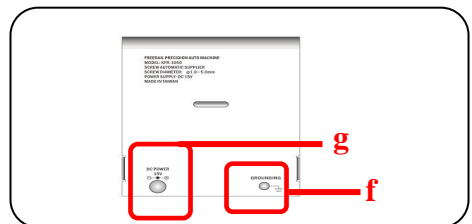



## MAINTENANCE & TROUBLE SHOOTING

※ TURN OFF THE POWER BEFORE REPAIR ※

| PROBLEM  | PROBABLE CAUSES   | SOLUTION   |
|--|---|--|
| No operating or with Buzzer sound when Power turned ON | There is no power supplied.   | Check the connect of adaptor   |
|  | The screw Chamber is overloaded with too many screws.                     | Remove some screw out to a proper level.   |
|  | Problem with Power Switch, Motor or PCB.                                  | Replace the faulty Switch, Motor or PCB.   |
|  | Screw (or something else) has fallen down in the machine.                 | Remove the screw dropped.  |
| Roller stopped   | Motor unit has stripped gear.   | Replace the Motor.   |
|  | Roller has got stuck or gears have been stripped.                         | Check whether Roller got stuck and replace it.   |
| No vibrated screw comes out.                           | Width of rail groove is incorrect.  | Adjust the width of rail groove.   |
|  | Screw with abnormal posture at Holding Plate was not swept away by Brush. | Remove the misplaced screw, and adjust height of Holding Plate.                            |
|  | Screw is caught at Holding Plate abnormally.                              | Remove the misplaced screw, and adjust height of Holding Plate.                            |
|  | Screw with abnormal posture stops halfway in the rail groove.             | Remove the screw with abnormal gesture as following steps.                                 |
|  |   | Adjust the improper height of Bit Guide Assembly.  |
|  |   | Slant the unit backward to make abnormal screws slip backward, taking out screws on rails. |
| Adjust the height of Holding Plate.                    |   |  |



## MAINTENANCE & TROUBLE SHOOTING

| PROBLEM                                     | PROBABLE CAUSES  | SOLUTION  |
|---|--|---|
| No vibrated screw comes out                 | Screw stuck in gap around the Rails.                           | Remove the obstructing screw stuck in.<br>Contact your dealer if problem is not caused by loaded screw. |
|   | Vibration Motor stops  | Contact your dealer if problem is not caused by loaded screw.   |
| No movement of the vibrated screws          | Gap too narrow between Plate and Screw head.                   | Adjust the Holding Plate  |
|   | Rails get dirty.   | Clean the Rails   |
|   | Rails with abnormal vibration                                  | Adjust the vibration strength   |
|   | Screw is jammed on Vibration Motor.                            | Remove the jammed screw.  |
| Abnormal can pass the gap of Holding Plate. | Vibration Motor failed.  | Replace Vibration Motor   |
|   | Misplaced screw has not been swept up                          | Adjust the Brush  |
| Screw can't reach to Stopper point.         | Holding Plate has not adjusted properly                        | Adjust the height of Holding Plate.   |
|   | Screws are stopped while still on Rails.                       | Adjust the height of Holding Plate.   |
|   | The rail groove is too narrow.                                 | Adjust the width of Rail Assembly   |
| Bit can't catch the fed screw punctually.   | The Rail is magnetic at front                                  | To demagnetize the Rail   |
|   | Bit Guide position is not adjusted to the center of Bit Guide. | Adjust the height of Holding Plate.   |
| Noise when Roller is turning                | Roller is stuck with screw or touching other parts.            | Power off   |
|   |  | Clear the fallen screw and adjust Rail Assembly.  |
| Screw falls into this machine               |  | Shake the screw out through the bottom hole of this machine.  |
|   |  | Open the Housing to pick out the screw.   |



## MAINTENANCE & CLEANING

### ※ CAUTION FOR THE ADJUSTING ※

Turn off the **POWER** before performing maintenance and cleaning.  
Remove all screws in the **CHAMBER** and **RAIL** groove before performing maintenance

#### **CLEANING THE RAILS:**

Use the Allen Key to loosen the screws in the Lock Gates on top and right side of machine separately. Make the inside gaps become opened to widest width. And Loosen the Rail fixing screw in the hole at left back corner of Bit Guide Assembly. Then withdraw the Rail Assembly, clean the Rail Groove and top of the Rail (area for screws flow) with a clean thin cotton cloth soaked with alcohol or benzine.

#### **REPLACE THE BRUSH:**

Replace the brush when brush hair is too worn and can not wipe down screws in an improper position.

#### **METHOD:**

Turn on power enable Brush wipe down toward the top of Rail Groove. Loosen and remove 2 screws on top and take out the Brush Assembly. Remove screws on Brush Assembly to disassemble the Brush, and replace it with new Brush.

In reverse order reassemble the new Brush Assembly back to the driving Shaft. Refer to "ADJUST THE BRUSH" for adjustment of new Brush Assembly.

**INTERIOR CLEANING** After cleaning the Rail Assembly, take out any screw or foreign material inside of machine, and clean whole interior parts, walls particularly the Motor & PCB to prevent effecting against machine functions.

### **OPTIONAL PARTS**

Please use genuine parts for ensure products quality and avoid influences caused against performance of this machine.

#### **Remark:**

When using screw of special types or other than specified, please consult our distributors.



## INTERNATIONAL WARRANTY CONDITIONS

1. For KILEWS Products exported from Taiwan, it is KILEWS responsibility to ensure the product delivered to customers' designated destinations. After reaching the destinations, KILEWS, KILEWS branch offices and KILEWS distributors shall not be responsible for any damage caused by handling or transportation arranged by customers themselves.
  - ※ Shall such damage occurred outside of KILEWS responsibility, customer will be liable to pay for the parts, labor, transportation cost to repair the products.
2. For products bought in Taiwan, KILEWS is responsible for repairs in Taiwan under warranty terms & conditions. However, if the said products require service or repair overseas during warranty period, KILEWS local branches / distributors / agents shall charge labor and transportation fee for the service / repair.
3. For products sold overseas, users shall, in principle, pay a basic service fee for repairs during the warranty period. The fee will be based on the repair quantity, product condition, average usage and labor required. Please contact your supplier for more detail.
4. A completed warranty card should be presented for any service or repair during the warranty period. Fail to do so will be considered as out of warranty. KILEWS local branches / distributors / agents shall charge parts, labor and transportation fee for such service / repair.
5. For all out of warranty repairs, no matter where the repair is carried out, users will be liable to pay for parts, labor and transportation based on the actual cost. KILEWS will continue to provide after-sale service even if the product is out of warranty. Shall any service issue arise at any time, please do not hesitate to contact Kilews.

Thank you for using our product.

**The design, performance and specifications are subject to change without prior notice for further improvement.**

**Please peruse the Operation Manual and Warranty Conditions.**



## WARRANTY CARD

**The warranty is valid for 12 months from purchase date (based on 8 working hours a day). Please contact your supplier during the warranty period for repair or maintenance.**

**The parts of screw-feeder include the warranty parts and the non-warranty parts. The warranty parts include: motor, PCB, sensor and AC adaptor. Besides are non-warranty parts.**

### NOTE:

1. The service cost shall be considered as chargeable if the failure /cost was induced by any of the following conditions:
  - Failure due to improper handling or un-authorized modification.
  - Failure arising from a cause or an accident beyond one's control or Act of God.
  - Failure has nothing to do with the original design of the machine.
  - Labor and parts cost to replace the consumable Parts (Brush, Bit Guide Assembly, Motor, Stopper, etc.).
2. The WARRANTY will be void under any of the following conditions:
  - It has been modified, altered and /or repaired by an unauthorized dealer, purchaser or third party.
  - The serial number, warranty card has been altered, de-faced and /or removed.
  - The Company was not promptly informed of any change of address or the ownership of the product.
  - Failing to use genuine parts sold or recommended by the Company.
3. The Company will not be liable for any loss directly or indirectly arising from breakdown of the Products.
4. Under this warranty, the Company only provides service at any time during normal business hours. Should emergency service is required outside normal business hours, and such service if available will be provided with a charge on a per call rate basis.
5. The warranty is not transferable without the consent of the Company.









## **Kilews Industrial Co., Ltd.**

E-mail : [kilews@ms6.hinet.net](mailto:kilews@ms6.hinet.net)

Website://[www.kilews.com](http://www.kilews.com)

Y2F097-1-002



## WARRANTY CARD

|                               |                                     |
|-------------------------------|-------------------------------------|
| <b>CUSTOMER</b>               |                                     |
| <b>TELEPHONE</b>              |                                     |
| <b>ADDRESS</b>                |                                     |
| <b>PURCHASE DATE</b>          |                                     |
| <b>Distributor :</b>          |                                     |
| <b>Automatic Screw Feeder</b> |                                     |
| <b>MODEL</b>                  | KFR-1050                            |
| <b>SERIAL NO.</b>             |                                     |
| <b>SCREW SIZE</b>             | 1.0~5.0mm                           |
| <b>SWITCHING ADAPTOR</b>      | DC IN 15V                           |
| <b>MEASUREMENT</b>            | Machine: 182(L)x126(W)x147(H)mm     |
|                               | Each Carton: 282(L)x142(W)x201(H)mm |
| <b>WEIGHT</b>                 | N.W 2.17kgs                         |
|                               | G.W 2.63kgs                         |

**REMARK:**



## **Kilews Industrial Co., Ltd.**

E-mail : [kilews@ms6.hinet.net](mailto:kilews@ms6.hinet.net)

Website://[www.kilews.com](http://www.kilews.com)