

Disc-Type Handwheels • light metal

24600.0120



Product Description

There are gripping indentations on the rear sides. For all handwheels, the hub is machined, rim is turned and mirror-finished on all sides. The unmachined raw surfaces have been blasted clean. Together with their mirror-polished rim, these handwheels therefore present a finish which generally does not require additional lacquering.

Material

Axle part

- Steel, zinc-plated by galvanization

Handwheel

- Aluminium permanent-mould casting

Assembly

Shaft-end washers EH 22270. for axial fastening.

More information

Further products

- Shaft-End Washers
- Cylindrical Handles, rotating

Drawing

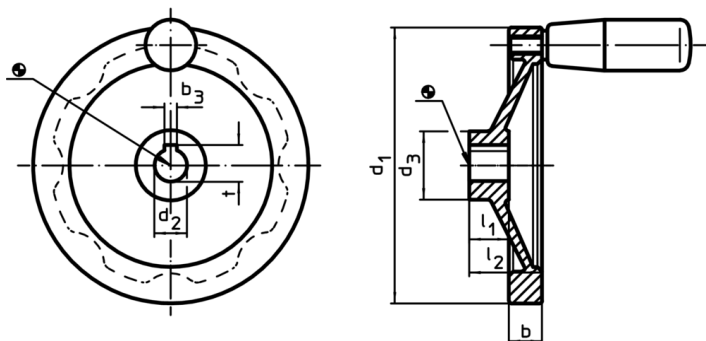

The orientation of the hub keyway may be different than shown in the drawing.

Order information

d ₁	d ₂ H7	Dimensions				Hub keyway, DIN 6885 sheet 1		[g]	Art. No.
		d ₃	b	l ₁	l ₂ ~	b ₃	t		
[mm]									
with keyway, without cylindrical handle									
160	14	36	18	20	39	5	16.3	529	24600.0120

Compliance

RoHS compliant

Contains lead - compliant according to exceptions 6a / 6b / 6c

Contains SVHC substances >0,1% w/w

Contains lead - SVHC list [REACH] as of 10.06.2022

Contains Proposition 65 substances



Lead can cause cancer and reproductive harm from exposure
<https://www.P65Warnings.ca.gov/>

Free from Conflict Minerals

This product does not contain any substances designated as "conflict minerals" such as tantalum, tin, gold or tungsten from the Democratic Republic of Congo or adjacent countries.