

# ACCESSORIES

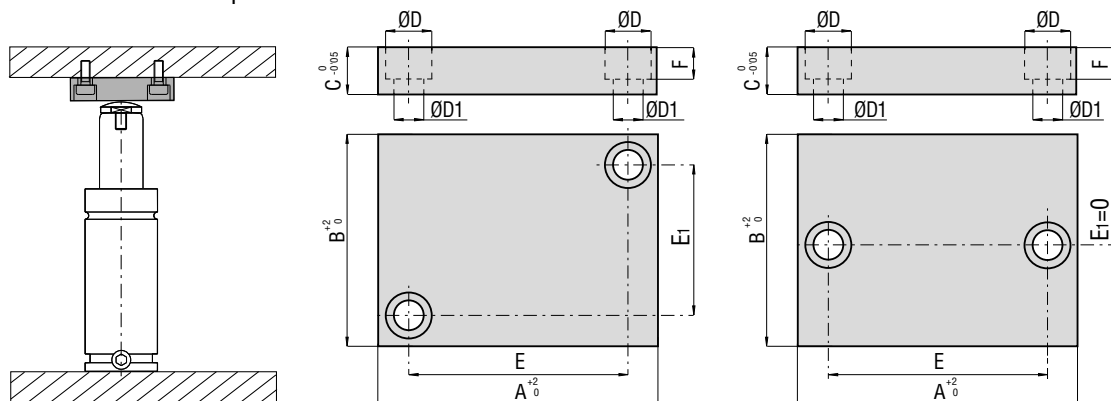

<b>IT</b>	<b>Piastra di contrasto</b>	Temperato
<b>EN</b>	<b>Counter plate</b>	Hardened
<b>DE</b>	<b>Stellplatten</b>	Gehärtet
<b>FR</b>	<b>Plaques d'appui</b>	Tempéré
<b>ES</b>	<b>Placas de apoyo</b>	Templado
<b>PT</b>	<b>Placas de apoi</b>	Temperado



PHASING OUT	CODE	A		B		C		Ø D		Ø D1		E		E1		F				
		mm	inch	mm	inch	mm	inch	mm	inch	mm	inch	mm	inch	mm	inch	mm	inch			
	PS040040	39PA040040A <sup>1) 5)</sup>	40	1.57	40	1.57	15	0.59	15	0.59	9	0.35	21	0.83	21	0.83	10	0.39	d ≤ 20	0.79
-		39PAB040040A <sup>4) 7)</sup>	40	1.57	40	1.57	12	0.47	11	0.43	7	0.28	24	0.94	24	0.94	7	0.28	d ≤ 20	0.79
-		39PAA040040A	40	1.57	40	1.57	15	0.59	11	0.43	7	0.28	24	0.94	24	0.94	7	0.28	d ≤ 20	0.79
	PS056056	39PA056056A <sup>3) 5)</sup>	56	2.20	56	2.20	20	0.79	18	0.71	11	0.43	32	1.26	32	1.26	13	0.51	d ≤ 36	1.42
-		39PA060060A <sup>4) 7)</sup>	60	2.36	60	2.36	15	0.59	15	0.59	9	0.35	40	1.57	40	1.57	9	0.35	d ≤ 36	1.42
-		39PAA060060A <sup>6)</sup>	60	2.36	60	2.36	12	0.47	14	0.55	9	0.35	38	1.5	38	1.5	9	0.35	d ≤ 36	1.42
-		39PA070070A <sup>1) 4) 7)</sup>	70	2.76	70	2.76	15	0.59	15	0.59	9	0.35	50	1.97	50	1.97	9	0.35	d ≤ 60	2.36
	PS071071	39PA071071A <sup>5)</sup>	71	2.80	71	2.80	20	0.79	18	0.71	11	0.43	48	1.89	48	1.89	13	0.51	d ≤ 60	2.36
-		39PA080080A <sup>2)</sup>	80	3.15	80	3.15	16	0.63	15	0.59	9	0.35	62	2.44	0	0	10	0.39	d ≤ 65	2.56
-		39PAB090090A	90	3.54	90	3.54	12	0.47	15	0.59	9	0.35	64	2.52	64	2.52	9	0.35	d ≤ 80	3.15
-		39PAA090090A <sup>1)</sup>	90	3.54	90	3.54	15	0.59	15	0.59	9	0.35	70	2.76	70	2.76	9	0.35	d ≤ 80	3.15
-		39PA090090A <sup>2) 3) 5)</sup>	90	3.54	90	3.54	20	0.79	18	0.71	11	0.43	67	2.64	67	2.64	13	0.51	d ≤ 80	3.15
-		39PAC090090A <sup>6)</sup>	90	3.54	90	3.54	12	0.47	14	0.55	9	0.35	70	2.76	70	2.76	9	0.35	d ≤ 80	3.15
-		39PA100100A <sup>2)</sup>	100	3.94	100	3.94	16	0.63	15	0.59	9	0.35	82	3.23	0	0	10	0.39	d ≤ 90	3.54
-		39PAA100100A <sup>4) 7)</sup>	100	3.94	100	3.94	20	0.79	18	0.71	11	0.43	74	2.91	74	2.91	11	0.43	d ≤ 90	3.54
-		39PAB100100A <sup>6)</sup>	100	3.94	100	3.94	12	0.47	14	0.55	9	0.35	81	3.19	81	3.19	9	0.35	d ≤ 90	3.54
-		39PAA140140A <sup>4)</sup>	140	5.51	140	5.51	20	0.79	18	0.71	11	0.43	110	4.33	110	4.33	11	0.43	d ≤ 130	5.12
-		39PA140140A <sup>3) 5)</sup>	140	5.51	140	5.51	20	0.79	18	0.71	11	0.43	110	4.33	110	4.33	13	0.51	d ≤ 130	5.12
	PS050025	39PA050025A <sup>1) 5)</sup>	50	1.97	25	0.98	12	0.47	11	0.43	7	0.28	32	1.26	8	0.31	8	0.31	d ≤ 15	0.59
	39PA050030A <sup>5)</sup>	-	50	1.97	30	1.18	12	0.47	11	0.43	7	0.28	40	1.57	14	0.55	8	0.31	d ≤ 20	0.79
-		39PA050030B <sup>5)</sup>	50	1.97	30	1.18	12	0.47	11	0.43	7	0.28	35	1.38	14	0.55	7	0.28	d ≤ 20	0.79
	PS055030	39PA055030A <sup>1)</sup>	55	2.17	30	1.18	12	0.47	11	0.43	7	0.28	40	1.57	14	0.55	8	0.31	d ≤ 20	0.79
-		39PA055032A <sup>2)</sup>	55	2.17	32	1.26	16	0.63	15	0.59	9	0.35	37	1.46	0	0	10	0.39	d ≤ 20	0.79
-		39PA065050A <sup>2)</sup>	65	2.56	50	1.97	16	0.63	15	0.59	9	0.35	47	1.85	0	0	10	0.39	d ≤ 36	1.42
	PS070035	39PA070035A <sup>1) 5)</sup>	70	2.76	35	1.38	15	0.59	15	0.59	9	0.35	48	1.89	14	0.55	10	0.39	d ≤ 30	1.18
	PS075050	39PA075050A <sup>1) 5)</sup>	75	2.95	50	1.97	15	0.59	15	0.59	9	0.35	56	2.2	30	1.18	10	0.39	d ≤ 36	1.42
-		39PA080060A <sup>2)</sup>	80	3.15	60	2.36	16	0.63	15	0.59	9	0.35	62	2.44	0	0	10	0.39	d ≤ 55	2.17
-		39PAA085060A <sup>5)</sup>	85	3.35	60	2.36	15	0.59	15	0.59	9	0.35	56	2.2	40	1.57	10	0.39	d ≤ 55	2.17
	PS085060	39PA085060A <sup>1)</sup>	85	3.35	60	2.36	15	0.59	15	0.59	9	0.35	66	2.6	40	1.57	10	0.39	d ≤ 55	2.17
	PS100080	39PA100080A <sup>1) 5)</sup>	100	3.94	80	3.15	20	0.79	18	0.71	11	0.43	72	2.83	56	2.2	12	0.47	d ≤ 70	2.76
	PS110100	39PA110100A <sup>5)</sup>	110	4.33	100	3.94	20	0.79	18	0.71	11	0.43	85	3.35	75	2.95	12	0.47	d ≤ 100	3.94

<sup>1)</sup> VDI 3003 <sup>2)</sup> Volvo <sup>3)</sup> Renault <sup>4)</sup> Volkswagen <sup>5)</sup> FCA <sup>6)</sup> Mercedes Benz <sup>7)</sup> BMW

All dimensions in mm/inch

<b>IT</b>	<b>Piastra di contrasto</b>	Temperato
<b>EN</b>	<b>Counter plate</b>	Hardened
<b>DE</b>	<b>Stellplatten</b>	Gehärtet
<b>FR</b>	<b>Plaques d'appui</b>	Tempré
<b>ES</b>	<b>Placas de apoyo</b>	Templado
<b>PT</b>	<b>Placas de apoi</b>	Temperado

CODE	Ø A		Ø B		C		D		Ø E		Ø F		mm	inch
	mm	inch	mm	inch	mm	inch	mm	inch	mm	inch	mm	inch		
▲ 39PA050A <sup>8)</sup>	50	1.97	29,6	1.17	15	0.59	10	0.39	15	0.59	9	0.35	d ≤ 15	0.59
▲ 39PA070A <sup>8)</sup>	70	2.76	45,2	1.78	20	0.79	13	0.51	18	0.71	11	0.43	d ≤ 25	0.98
▲ 39PA094A <sup>8)</sup>	94	3.70	67,8	2.67	20	0.79	13	0.51	18	0.71	11	0.43	d ≤ 50	1.97

8) Fiat

▲ Phasing out

CODE	Ø A		Ø B		C		D		Ø E		Ø F		mm	inch
	mm	inch	mm	inch	mm	inch	mm	inch	mm	inch	mm	inch		
■ 39PA050B <sup>5)</sup>	50	1.97	21	0.83	15	0.59	10	0.39	15	0.59	9	0.35	d ≤ 15	0.59
■ 39PA070B <sup>5)</sup>	70	2.76	32	1.26	20	0.79	13	0.51	18	0.71	11	0.43	d ≤ 25	0.98
■ 39PA094B <sup>5)</sup>	94	3.70	48	1.89	20	0.79	13	0.51	18	0.71	11	0.43	d ≤ 50	1.97

5) FCA

CODE	Ø A		Ø B		C		D		Ø E		Ø F		mm	inch
	mm	inch	mm	inch	mm	inch	mm	inch	mm	inch	mm	inch		
39PA098A <sup>4)</sup>	98	3.86	73	2.87	20	0.79	73	2.87	20	0.79	13,5	0.53	d ≤ 50	1.97
39PA113A <sup>4)</sup>	113	4.45	88	3.46	20	0.79	88	3.46	20	0.79	13,5	0.53	d ≤ 65	2.58
39PA128A <sup>4)</sup>	128	5.04	103	4.06	20	0.79	103	4.06	20	0.79	13,5	0.53	d ≤ 80	3.15
39PA143A <sup>4)</sup>	143	5.63	118	4.65	20	0.79	118	4.65	20	0.79	13,5	0.53	d ≤ 95	3.74

4) Volkswagen

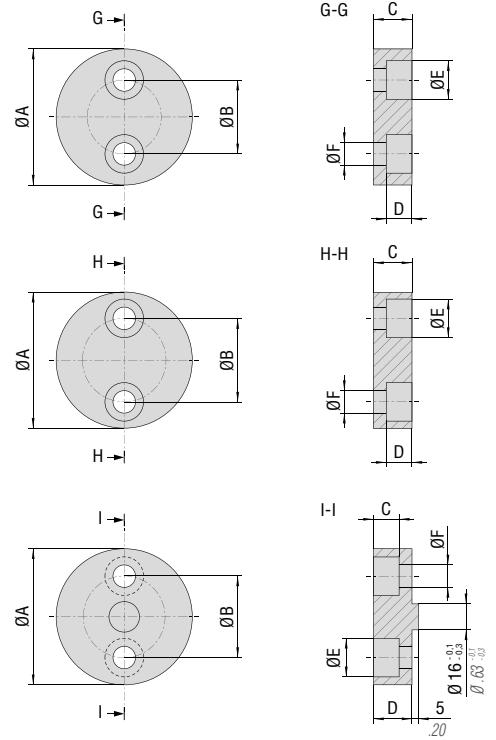

## code FA 022

<b>IT</b>	<b>Calotta</b>	Temperato
<b>EN</b>	<b>Thrust plates</b>	Hardened
<b>DE</b>	<b>Schaftkappe</b>	Gehärtet
<b>FR</b>	<b>Calotte pour tiges</b>	Tempré
<b>ES</b>	<b>Casquillo para vástagos</b>	Templado
<b>PT</b>	<b>Calote para embolo</b>	Temperado

49 - 52 HRC

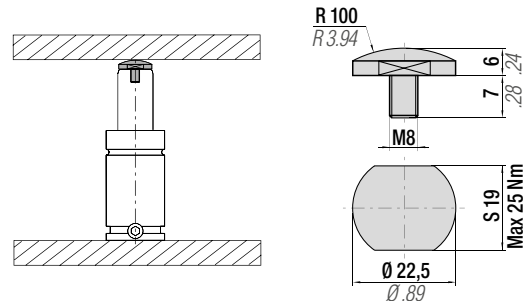

<b>IT</b>	<b>Pressostato</b>	Tensione di lavoro 48 V max	Normalmente aperto
<b>EN</b>	<b>Pressure switch</b>	Operating voltage 48 V max	Normally opened
<b>DE</b>	<b>Druckwächter</b>	Arbeitsspannung 48 V max	Normalerweise offen
<b>FR</b>	<b>Pressostat</b>	Tension d'utilisation 48 V max	Normalement ouvert
<b>ES</b>	<b>Presostato</b>	Tensión de trabajo 48 V max	Normalmente abierto
<b>PT</b>	<b>Pressostato</b>	Tensão de Trabalho 48 V max	Normalmente aberto

## PRESSURE SWITCH

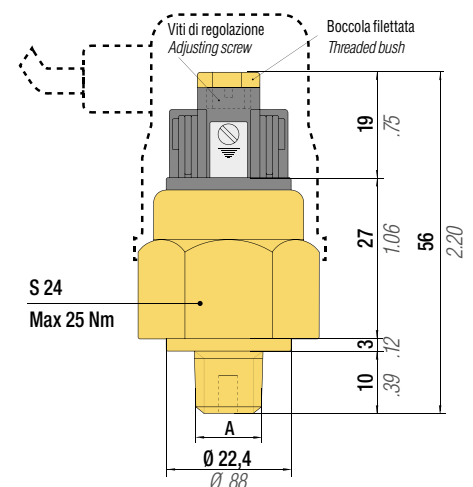

CODE	A	Range
PMM150A	1/8 " BSPT	50:150 bar
PMM300A	1/8 " BSPT	50:300 bar
PMM150A01	1/4 " BSPT	50:150 bar
PMM300A01	1/4 " BSPT	50:300 bar

All dimensions in mm/inch

## code 39DMA



- IT** Dispositivo completo per le operazioni di controllo, riduzione/aumento della pressione o caricamento di cilindri autonomi e sistemi collegati.
- EN** Complete device designed and built for checking operations, decreasing/increasing pressure, or charging self-contained gas springs and linked systems.
- DE** Komplette Vorrichtung zur Kontrolle Operationen, Verminderung / Erhöhung des Drucks, oder Ladung die Selbstständigen gasdruckfedern und verbundenen Systemen.
- FR** Dispositif complet pour les opérations de contrôle, réduction/augmentation de la pression ou chargement de cylindres autonomes et systèmes reliés.
- ES** Dispositivo completo para las operaciones de control, reducción/aumento de la presión o carga de cilindros autónomos y sistemas conectados.
- PT** Dispositivo completo para as operações de controle, redução/aumento da pressão ou carregamento dos cilindros autônomos e sistemas conectados.

### Box content:

1	39DMCILA (1 pcs)
2	39DMCPVA (1 pcs) included 39IR01A (1 pcs)
3	ADM01 (1 pcs) - ADM02 (1 pcs) - ADM03 (1 pcs) - ADM04 (1 pcs) - ADM05 (1 pcs) - ADM06 (1 pcs) - ADM08 (1 pcs) - ADM09 (1 pcs)
-	Declaration of CE conformity - User manual

### Installation Example

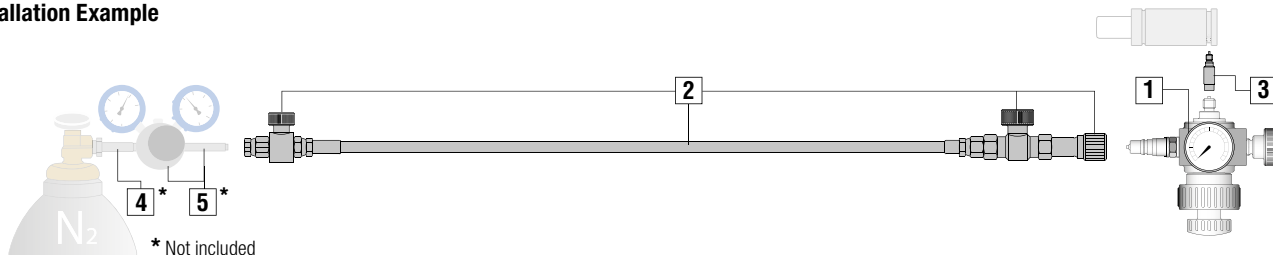

- 4\* Attacco per bombola - Connection for bottle - Ansatz für die Flasche - Décapage pour bombonne - Conexión para bombona - Ataque a Bottle **p.324**
- 5\* Riduttore di pressione - Pressure reducer - Druckminderer - Réducteur de pression - Reductor de presión - Redutor de pressão **p.325**

## code 39DMCILA



- IT** Manometro 0 ÷ 315 bar - 2 manopole - valvola di riduzione/scarico pressione - adattatore fisso G1/8" - attacco rapido maschio Cejn.
- EN** 0 ÷ 315 bar gauge - 2 hand knobs- pressure limitation/discharging valve - G1/8" built in adapter - quickfit male Cejn.
- DE** Manometer 0 ÷ 315 bar - 2 Drehknopfs - Entlüftungsventil - fester Adapter G1/8" - Schnellverschlusskupplung Stecker Cejn.
- FR** Manomètre 0 ÷ 315 bar - 2 poignées - soupape de réduction/déchargement pression - Adaptateur fixe G1/8" - enclenchement instantané mâle Cejn.
- ES** Manómetro 0 ÷ 315 bar - 2 manillas - válvula de reducción/descarga de presión - adaptador fijo G1/8" - enchufe rápido macho Cejn.
- PT** Manómetro 0 ÷ 315 bar/psi - 2 manoplas - válvula de redução/descarga pressão - adaptador fixo G1/8" - engate rápido macho Cejn.

## code 39DMCPVA



- IT** 3 mt di tubo - attacco rapido femmina Cejn - valvola ON/OFF - valvola di scarico tubo - 1 innesto rapido supplementare (cod. 39IR01A - SOLO PER CPVB - CPVD).
- EN** 3 Mt high pressure hose- quickfit female Cejn- shut-off valve- hose release valve -additional quick coupling (cod. 39IR01A - ONLY FOR CPVB - CPVD).
- DE** 3 Meter Schlauch- Schnellverschlusskupplung Muffe Cejn- Sperrventil- Rohr Ablassventil- 1 zusätzliche Schnellverschluss Kupplung (im. 39IR01A - NUR FÜR CPVB-CPVD KONTROLLARMATUR).
- FR** 3 m de tuyau – enclenchement instantané femelle Cejn – soupape ON/OFF – soupape de déchargement tuyau - 1 enclenchement instantané supplémentaire (cod. 39IR01A - UNIQUEMENT POUR CPVB - CPVD).
- ES** 3 mt de tubo - enchufe rápido hembra Cejn - válvula ON/OFF - válvula de descarga tubo - 1 enchufe rápido suplementario (cod. 39IR01A - SOLO PARA CPVB - CPVD).
- PT** 3 mt de tubo – engate rápido fêmea Cejn - válvula ON/OFF - válvula de descarga tubo - 1 engate rápido suplementar (cod. 39IR01A - SOMENTE PARA CPVB - CPVD).

## code 39IR01A



ISO 72 - C - 2 - 2 - RP

- IT** Innesto rapido femmina per dispositivo 39DMCPVA (USARE SOLO CON PANNELLI CPVB - CPVD).
- EN** Quickfit female coupling for device 39DMCPVA (SUITABLE ONLY FOR CPVB - CPVD PANELS).
- DE** Schnellverschlusskupplung Muffe für Ausstattung 39DMCPVA (NUR FÜR CPVB - CPVD KONTROLLARMATUR).
- FR** Enclenchement instantané femelle pour dispositif 39DMCPVA (N'UTILISER QU'AVEC PANNEAUX CPVB - CPVD).
- ES** Enchufe rápido hembra para dispositivo 39DMCPVA (USO SOLAMENTE CON PANELES CPVB - CPVD).
- PT** Engate rápido fêmea para dispositivo 39DMCPVA (USE UNICAMENTE COM PAINÉIS CPVB - CPVD).

## code 39IRFA

⚠ Only for 39DMCPV



Cejn 358

- IT** Innesto rapido femmina per dispositivo 39DMCPV (NON USARE CON PANNELLI CPVB - CPVD).
- EN** Quickfit female coupling for device 39DMCPV (NOT SUITABLE FOR CPVB - CPVD PANELS).
- DE** Schnellverschlusskupplung Muffe für Ausstattung 39DMCPV (NICHT MIT CPVB - CPVD ARMATUR VERWENDEN).
- FR** Enclenchement instantané femelle pour dispositif 39DMCPV (NE PAS UTILISER AVEC PANNEAUX CPVB - CPVD).
- ES** Enchufe rápido hembra para dispositivo 39DMCPV (NO USAR CON PANELES CPVB - CPVD).
- PT** Engate rápido fêmea para dispositivo 39DMCPV (NÃO USE COM PAINÉIS CPVB - CPVD).

## code 39QDFV01 for 1/8G thread code 39QDFV02 for M6 thread code 39QDFV03 for M6 thread



- IT** Adattatore per caricamento diretto con innesto rapido maschio Cejn.
- EN** Cejin male quick fit adapter for direct charging.
- DE** Adapter für direkt Ladung mit Schnellverschlusskupplung Stecker Cejin.
- FR** Adaptateur direct pour le chargement avec enclenchement instantané mâle Cejin.
- ES** Adaptador para carga directa con enchufe rápido macho Cejin.
- PT** Adaptador direto para la carga con engate rápido macho Cejin.

⚠ tab below.

Code	39QDFV01	39QDFV03	39QDFV02	39QDFV03	39QDFV02	39QDFV02	39QDFV02	39QDFV03	39QDFV01
Modello Model Modell Model Modelo Modelo	ML1800 - 12000 (rev A)	HR300 Cu 5 - 16 HR500 Cu 5 - 16 HR700 Cu 10 - 16 HRF700 Cu 10 - 16 ML500 ML1000 LI400 Cu 13	NE16, NE24 (rev A) HR1000 - 4200 HRF1000 LI900 - 2000	SC150, SC250 SCF250, H300 H500, HF500 HR500 Cu 25 - 125 HR700 Cu 19 - 125 HRF500 Cu 25 - 125 HRF700 Cu 19 - 125 LI400 Cu 25 - 100	K40 ML300	HR200 MCS19 MCS19 - TBM MCS19 - TBI MCS19 - TEM MCS25	NE16 - NE24 (revB) NG16 - NG24 M50 - M70 M90 - MS90 M90 TBM - TBI - TEM M200 - MS200 M300 KE400 - 7500 RV170 - 2400 RS170 - 2400 SC150 - 250 (rev D) H 300 - 500 (rev C) ML300 (rev B+C) MP150	ML500-1000 (rev B+C) MP300 - 3000 MQ700	SC500 - 10000, SCF500 - 750 H700 - 18500 HF700 - 1000 HR6600 - 11800 LI3200 LS1500 - 9500 KE12000 - 18500 S500 - S3000 RV4200 - RV20000 RS4200 - RS9500 RF750 - RF2400 RG750 - RG6600 RT350 - RT9500 ML1800 - ML12000 (rev B+C)
A	G1/8"	M6	M6	M6	M6	M6	M6	M6	G 1/8"
Code	ADM01	ADM02	ADM03	ADM04	ADM05	ADM06	ADM08	ADM09	Direttamente con 39DMCILA (senza adattatore) Directly with 39DMCILA (without adapter) Direkt mit 39DMCILA (ohne Adapter) Directement avec 39DMCILA (sans adaptateur) Directamente con 39DMCILA (sin adaptador) Directamente com 39DMCILA (sem adaptador)

## code ADM...

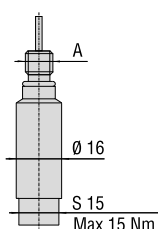

- IT** Adattatore per dispositivo 39DMCILA.
- EN** Adapter for 39DMCILA device.
- DE** Adapter für 39DMCILA Vorrichtung.
- FR** Adaptateur pour dispositif 39DMCILA.
- ES** Adaptador para dispositivo 39DMCILA.
- PT** Adaptador para dispositivo 39DMCILA.

⚠ tab above.

# ACCESSORIES



code 39DDS-...

**IT** Dispositivo di scaricamento.

**DE** Ablassvorrichtung.

**ES** Dispositivo de descarga.

**EN** Discharging device.

**FR** Dispositif de déchargement.

**PT** Dispositivo de descarga.

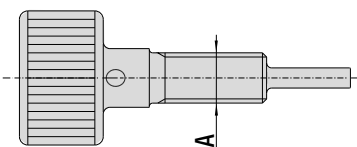

Code	39DDS-M6/1	39DDS-M6/2	39DDS-M6/3	39DDS-1/8G1	39DDS-1/8G	
A	M6	M6	M6	G 1/8"	G 1/8"	
Model	MCS K ML (rev. A) HR LI	NE (rev. A) SC (rev. B) H (rev. A) HR LI	NE (rev. B) NG M MS KE	K ML (rev. A)	SC H HR LI LS	KE ML (rev. B) S RV RS RF RT RG

**39DDS01A**

**39DDS01A**

code 39DDS01A

**IT** Dispositivo di scaricamento.

**DE** Ablassvorrichtung.

**ES** Dispositivo de descarga.

**EN** Discharging device.

**FR** Dispositif de déchargement.

**PT** Dispositivo de descarga.

A	M6		
Model	NE (rev. B) NG M MS	KE ML (rev. B-C-D) MP MQ	RV RS SC (rev. D-E) H (rev. C-D)



A	G 1/8"		
Model	SC H HR LI	LS KE ML (rev. B) S	RV RS RF RT RG

code 58UT029A

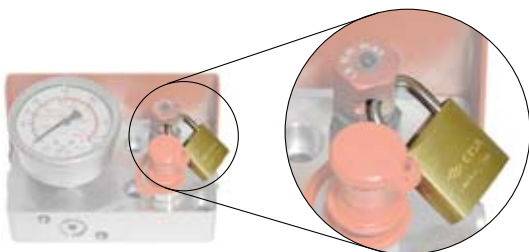

**IT** Lucchetto blocca valvola di scarico.

**EN** Padlock for discharge valve.

**DE** Vorhängeschloss für das Ablassventil.

**FR** Verrou pour soupape de décharge.

**ES** Candado de bloqueo de la válvula de descarga.

**PT** Cadeado para tramcar a valvula de descarregamento.

## HOW TO USE IT

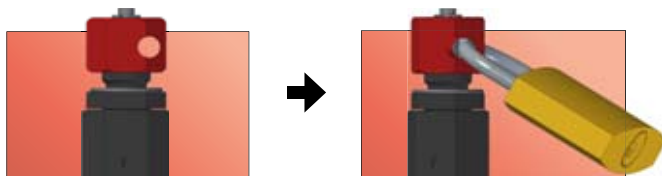

## WHY TO USE IT

**IT** Per impedire caricamenti **NON autorizzati** durante la manutenzione.

**EN** To prevent **UNauthorized** charging during maintenance.

**DE** Um **unbefugtes** Befüllen zu verhindern bei der Wartung.

**FR** Pour empêcher le chargement **NON autorisé** pendant l'entretien.

**ES** Para impedir cargas **NO autorizadas** durante el mantenimiento.

**PT** Para impedir o carregamento **SEM autorização** durante a manutenção.

## BENEFITS

**IT** Manutenzioni più sicure e con meno incidenti.

**EN** Safer maintenance and less accidents.

**DE** Mehr Sicherheit bei der Wartung und weniger Unfälle.

**FR** Un entretien plus sûr et moins d'accidents.

**ES** Mantenimientos más seguros y con menos accidentes.

**PT** Manutenção mais segura e com menos acidentes.

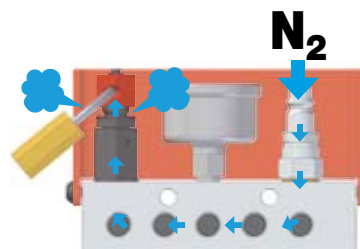

## code 39SP01A

- IT** Sensore di pressione con display digitale. Collegando direttamente il sensore di pressione al controllo pressa è possibile impostare un range di lavoro desiderato al di fuori del quale il dispositivo invierà un segnale di allarme.
- EN** Pressure sensor with digital display. By connecting the pressure sensor directly to the press control, it is possible to set a desired working range outside which the unit sends an alarm signal.
- DE** Drucksensor mit Digitalanzeige. Wenn man den Drucksensor direkt an die Pressensteuerung anschließt, ist es möglich einen gewünschten Arbeitsbereich einzustellen, außerhalb dessen das Gerät ein Alarmsignal sendet.
- FR** Capteur de pression avec affichage numérique. En connectant le capteur de pression directement au système de contrôle de la presse, il est possible de définir une plage de fonctionnement souhaitée en dehors de laquelle l'unité envoie un signal d'alarme.
- ES** Sensor de presión con pantalla digital. Conectando directamente el sensor de presión al control de la prensa, es posible establecer un rango de trabajo deseado fuera del cual el dispositivo enviará una señal de alarma.
- PT** Sensor de pressão com display digital. Conectando o painel ao comando da prensa, é possível determinar uma faixa de trabalho, que qualquer alteração desta faixa, o painel emitira um alarme.

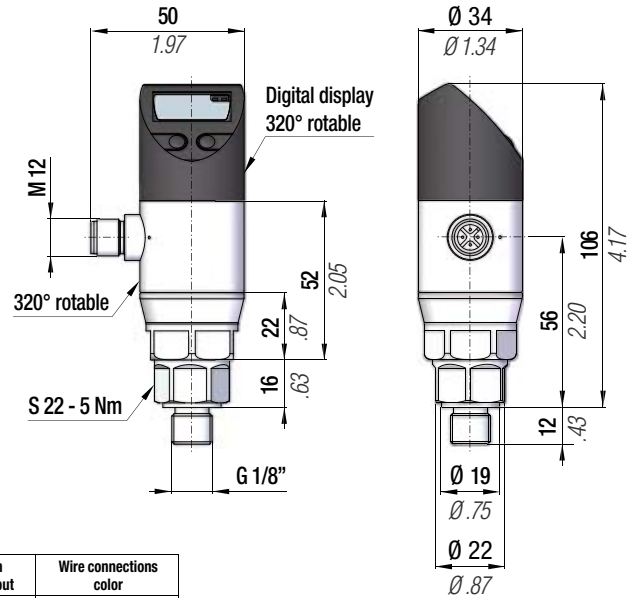

Technical data	
Electrical connector type	M12x1 - Male (4-pin)
Pressure connection	G 1/4" DIN 3852
Nominal pressure	0 - 600 bar
Burst pressure	1100 bar
Operating voltage U <sub>o</sub>	18...36 V DC
Output current max.	500 mA
No-load supply current I <sub>o</sub> max	≤ 50 mA
Switching frequency f	200 Hz
Temperature range	- 25°C... + 85°C
Degree of protection as per IEC 60529	IP67 when connected
Output: digital data (switching points only) 2xPNP, NO/NC selection	

Electrical connections	Sensors with switching output	Wire connections color
Supply +	1	Brown
Supply -	3	Blue
Signal +	-	White
Switching output 1	4	Black
Switching output 2	2	-
Shield	Connector housing	-

Sensor circuit diagram with 2 switching outputs PNP

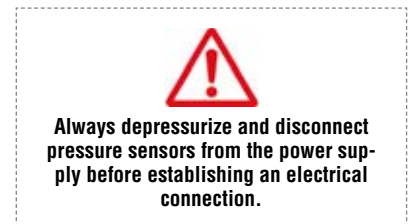
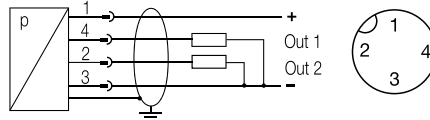

- IT** Tappo di sicurezza sovrappressione CE.
- EN** Overpressure safety plug CE.
- DE** Überdruck Sicherheitsstecker CE.
- FR** Bouchon de sécurité surpression CE.
- ES** Tapón de seguridad por sobrepresión CE.
- PT** Bujão de segurança sobrepressão CE.

## code: 39TS300

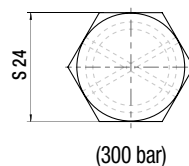
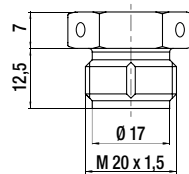

## code: 39TS360

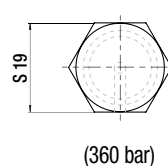
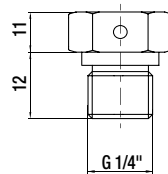

## code: 39TS460

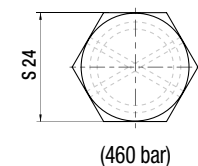
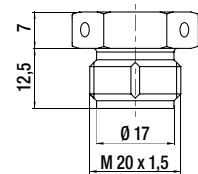

## code 58UT037A

- IT** Utensile per avvitare e svitare i cilindri SCF 250 e HF 500.
- EN** Tool to screw and unscrew gas springs SCF 250 and HF 500.
- DE** Schlüssel zum An- und Abschrauben von Gasdruckfedern SCF 250 und HF 500.
- FR** Outil pour visser et dévisser les ressorts à gaz SCF 250 et HF 500.
- ES** Herramienta para atornillar y desatornillar resortes de gas SCF 250 y HF 500.
- PT** Ferramenta para parafusar e desparafusar molas a gás SCF 250 e HF 500.

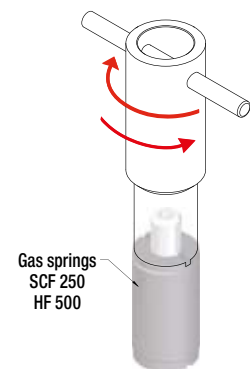
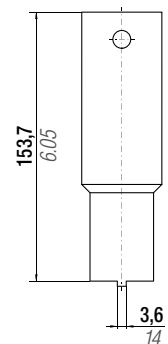
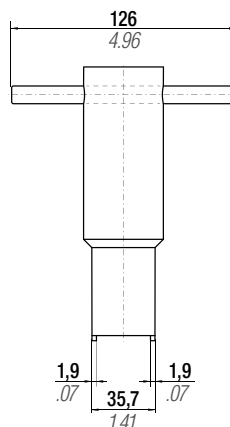

All dimensions in mm/inch

# ACCESSORIES



- IT** Chiave dinamometrica con accessori.
- EN** Torque wrench with accessories.
- DE** Drehmomentschlüssel mit Zubehör.
- FR** Clé dynamométrique avec ses accessoires.
- ES** Llave dinamométrica con accesorios.
- PT** Chave dinamométrica com acessórios.



Torque force

code	Nm
58UT025A	4 - 40



code  
58UT013A

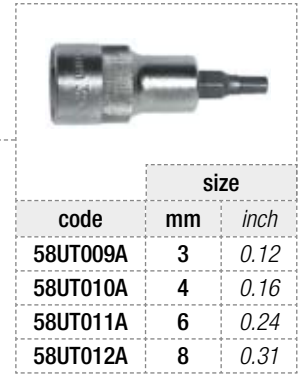

code	size	
	mm	inch
58UT009A	3	0.12
58UT010A	4	0.16
58UT011A	6	0.24
58UT012A	8	0.31



code	size	
	mm	inch
58UT014A	10	0.39
58UT015A	12	0.47
58UT016A	14	0.55
58UT017A	15	0.59
58UT018A	17	0.67
58UT019A	18	0.71
58UT020A	19	0.75

## ORDERING EXAMPLE

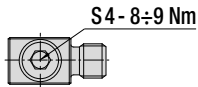
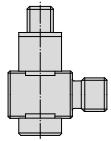

S4 - 8÷9 Nm



58UT025A  
+  
58UT013A  
+  
58UT010A

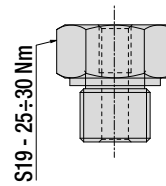

S19 - 25÷30 Nm



58UT025A  
+  
58UT020A

## WARNING PLATE

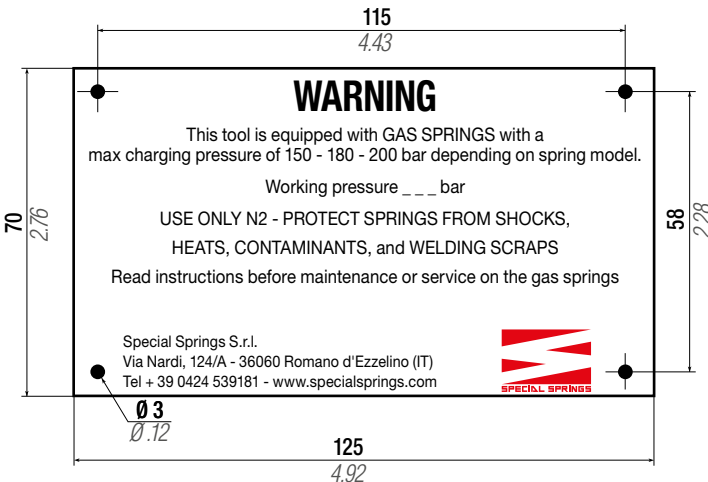

- IT** Targhetta
- EN** Advice plate
- DE** Schilder
- FR** Plaquettes
- ES** Placas
- PT** Etiquetas

Codice	39 TAR-I
Code	39 TAR-GB
Bestellnummer	39 TAR-D
Référence	39 TAR-F
Codigo	39 TAR-E
Codigo	39 TAR-P



code	Service tools	Service accessories
CMC	✓	✓

**IT** Set completo per manutenzione cilindri.

**FR** Kit d'entretien complet pour ressorts à gaz.

**EN** Service tools and Accessories for gas spring maintenance.

**ES** Kit de mantenimiento completo para resortes de gas.

**DE** Komplettes Wartungsset für Gasdruckfedern.

**PT** Kit de manutenção completo para cilindros.



code	Service tools	Service accessories
CMCT	✓	✗

**IT** Solo set utensili per manutenzione cilindri.

**FR** Set d'outils pour l'entretien de ressorts à gaz.

**EN** Service tools for gas spring maintenance.

**ES** Set de herramientas para mantenimiento de resortes de gas.

**DE** Nur Werkzeugsset zur Wartung von Gasdruckfedern.

**PT** Conjunto de ferramentas para manutenção dos cilindros.



code	Service tools	Service accessories (specific family of gas springs)
CMC - ...	✗	✓

**IT** Set accessori per determinata famiglia di cilindri (es. CMC-SC 10000).

**FR** Jeu d'accessoires pour une famille donnée de cylindres (ex.: CMC-SC 10000).

**EN** Service accessories for maintenance of a specific gas spring model (ex. CMC-SC 10000).

**ES** Set de accesorios para una determinada familia de cilindros (p.ej. CMC-SC 10000).

**DE** Zubehörset für bestimmte Zylindertypen (z. B. CMC-SC 10000).

**PT** Acessórios de conjunto para determinada família de cilindros (ex. CMC-SC 10000).

## code 58CD01



**IT** Cacciavite dinamometrico per valvola unidirezionale.

**EN** Torque screwdriver for one-way valve.

**DE** Drehmomentschrauber für Rückschlagventil.

**FR** Tournevis dynamométrique pour valve anti-retour.

**ES** Destornillador dinámico para válvula anti-retorno.

**PT** Chave torquimétrica para válvula de retenção.

## code 39PM02A



**IT** Pressa manuale per assemblaggio stelo, boccia e anello di ritegno a C.

**EN** Table manual press for assembly of rod, bushing and retaining C-ring.

**DE** Manuelle Presse zur Montage von Kolbenstange, Buchse und Sprengtring.

**FR** Presse manuelle pour l'assemblage de la tige, douille et bague d'étanchéité en C.

**ES** Prensa manual para ensamblaje vástago, casquillo y anillo de retención a C.

**PT** Prensa manual para ensambladura haste, bucha e anel de retenção a C.

## code 59VU02A



**IT** Valvola unidirezionale (esclusi M50-TBI/TBM1/TBM2/TEM, M70, M90-TBM/TEM/TBI, MS90, M/MS200, RV/RS170, RV/RS320).

**EN** One-way valve (excluding M50-TBI/TBM1/TBM2/TEM, M70, M90-TBM/TEM/TBI, MS90, M/MS200, RV/RS170, RV/RS320).

**DE** Rückschlagventil (außer M50-TBI/TBM1/TBM2/TEM, M70, M90-TBM/TEM/TBI, MS90, M/MS200, RV/RS170, RV/RS320).

**FR** Valve anti-retour (à l'exclusion de M50-TBI/TBM1/TBM2/TEM, M70, M90-TBM/TEM/TBI, MS90, M/MS200, RV/RS170, RV/RS320).

**ES** Válvula anti-retorno (excepto M50-TBI/TBM1/TBM2/TEM, M70, M90-TBM/TEM/TBI, MS90, M/MS200, RV/RS170, RV/RS320).

**PT** Válvula de retenção (excluindo M50-TBI/TBM1/TBM2/TEM, M70, M90-TBM/TEM/TBI, MS90, M/MS200, RV/RS170, RV/RS320).

## Product Suggestion



**IT** Spray rivelatore di fughe.

**EN** Gas detector.

**DE** Gasdetektor Spray.

**FR** Spray détecteur de fuites de gaz.

**ES** Spray detector de escapes de gas.

**PT** Spray revelador de fugas de gás.

Potential supplier  
www.tecnogas.net



# ACCESSORIES



- IT** Attacco per bombola.
- EN** Connection for bottle.
- DE** Ansatz für die Flasche.
- FR** Décapage pour bombonne.
- ES** Adaptador para bombona
- PT** Ataque a Bottle.

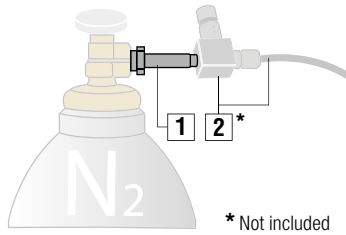

\* Not included

## Installation Example

<p><b>1</b> Attacco per bombola Connection for bottle Ansatz für die Flasche Décapage pour bombonne Adaptador para bombona Ataque a Bottle</p>	<p><b>2*</b> Tubo collegamento bombola con valvola di scarico Connecting hose from the bottle to the valve discharging Verbindungsschlauch der Flasche mit Auslassventil Tube pour la connexion bombonne avec valve de décharge Tubo de conexión a bombona con válvula de descarga Tubo de ligação Frasco com a válvula de descarga</p>
--	---

code	X	Box content	Country
47TB	W 21,7x1/14" - Male - ISO 228	O-ring 1/4" BSP	IT - Italy PT - Portugal
47TB01	-	O-ring 1/4" BSP	CN - China KR - South Korea
47TB02	W 22,5 - 14 t.p.i JIS B 8246 - Male	O-ring 1/4" BSP	JP - Japan ID - Indonesia
47TB03	W 24,32x1/14" - DIN 477 - 1 Female (for bottles up to 200 bar / 2900 psi)	O-ring 1/4" BSP	DE - Germany
47TB04	d 21,7x1,814 - NF E 29 - 650 - Female	O-ring 1/4" BSP	FR - France
47TB05	G 5/8" - ISO 228 - Male	O-ring 1/4" BSP	IN - India
47TB06	G 3/4" - ISO 228 - Female	O-ring 1/4" BSP	RU - Russia
47TB07	0.960 - 14 NGO - RH - Male - CGA NO. 580 (for bottles up to 206 bar / 3000 psi)	O-ring 1/4" BSP	US - United States
47TB08	1.040 - 14 NGO - RH - Male - CGA NO. 680 (for bottles from 206 bar / 3000 psi to 324 bar / 4700 psi)	O-ring 1/4" BSP	US - United States
47TB09	W 21,7x1/14 - Female	O-ring 1/4" BSP	ES - Spain
■ 47TB10	W 24,32x1/14 - DIN 477 - 1 - Female	O-ring 1/4" BSP	KR - South Korea
■ 47TB11	W 30x2 - DIN 477 - 5 - Female (for bottles from 200 bar / 2900 psi to 300 bar / 4351 psi)	O-ring 1/4" BSP	DE - Germany
■ 47TB12	G 3/4A - RH IS 3224 - Female	O-ring 1/4" BSP	IN - India
■ 47TB13	W 22 - 14 t.p.i JIS B 8246 - Male	O-ring 1/4" BSP	JP - Japan
■ 47TB14	W 30x2 - DIN 477 - 5 - Male (for bottles from 200 bar / 2900 psi to 300 bar / 4351 psi)	O-ring 1/4" BSP	PT - Portugal
■ 47TB15	G 5/8" - ISO 228 - Male	O-ring 1/4" BSP	UK - United Kingdom

code	Box content	Country
<b>Phasing out</b>	<b>New</b>	<b>1 + 2</b>
<b>39RP</b> (max. inlet pressure 200 bar / 2900 psi)	<b>39RHP</b> (max. inlet pressure 300 bar / 4350 psi)	IT - Italy PT - Portugal
<b>39RP01</b> (max. inlet pressure 200 bar / 2900 psi)	<b>39RHP01</b> (max. inlet pressure 300 bar / 4350 psi)	CN - China KR - South Korea
<b>39RP02</b> (max. inlet pressure 200 bar / 2900 psi)	<b>39RHP02</b> (max. inlet pressure 300 bar / 4350 psi)	JP - Japan ID - Indonesia
<b>39RP03</b> (max. inlet pressure 200 bar / 2900 psi)	<b>39RHP03</b> (max. inlet pressure 200 bar / 2900 psi) (for bottles up to 200 bar / 2900 psi)	DE - Germany
<b>39RP04</b> (max. inlet pressure 200 bar / 2900 psi)	<b>39RHP04</b> (max. inlet pressure 300 bar / 4350 psi)	FR - France
<b>39RP05</b> (max. inlet pressure 200 bar / 2900 psi)	<b>39RHP05</b> (max. inlet pressure 300 bar / 4350 psi)	IN - India
<b>39RP06</b> (max. inlet pressure 200 bar / 2900 psi)	<b>39RHP06</b> (max. inlet pressure 300 bar / 4350 psi)	RU - Russia
<b>39RP07</b> (max. inlet pressure 200 bar / 2900 psi)	<b>39RHP07</b> (max. inlet pressure 300 bar / 4350 psi) (for bottles up to 206 bar / 3000 psi)	US - United States
<b>39RP08</b> (max. inlet pressure 200 bar / 2900 psi)	<b>39RHP08</b> (max. inlet pressure 300 bar / 4350 psi) (for bottles from 206 bar / 3000 psi to 324 bar / 4700 psi)	US - United States
<b>39RP09</b> (max. inlet pressure 200 bar / 2900 psi)	<b>39RHP09</b> (max. inlet pressure 300 bar / 4350 psi)	ES - Spain
<b>39RP10</b> (max. inlet pressure 200 bar / 2900 psi)	<b>39RHP10</b> (max. inlet pressure 300 bar / 4350 psi)	KR - South Korea
<b>39RP11</b> (max. inlet pressure 200 bar / 2900 psi)	<b>39RHP11</b> (max. inlet pressure 300 bar / 4350 psi) (for bottles from 200 bar / 2900 psi to 300 bar / 4350 psi)	DE - Germany
<b>39RP12</b> (max. inlet pressure 200 bar / 2900 psi)	<b>39RHP12</b> (max. inlet pressure 300 bar / 4350 psi)	IN - India
<b>39RP13</b> (max. inlet pressure 200 bar / 2900 psi)	<b>39RHP13</b> (max. inlet pressure 300 bar / 4350 psi)	JP - Japan
<b>39RP14</b> (max. inlet pressure 200 bar / 2900 psi)	<b>39RHP14</b> (max. inlet pressure 300 bar / 4350 psi) (for bottles from 200 bar / 2900 psi to 300 bar / 4350 psi)	PT - Portugal
—	<b>39RHP15</b> (max. inlet pressure 300 bar / 4350 psi)	UK - United Kingdom

**IT** Riduttore di pressione completo di attacco bombola per controllare e ridurre la pressione.

**EN** Pressure reducer complete with gas spring connection to control and reduce the pressure.

**DE** Druckminderer komplett mit Flaschen-Anschluss, um den Druck zu kontrollieren und verringern.

**FR** Réducteur de pression complet avec jonction de bouteille pour contrôler et réduire la pression.

**ES** Reductor de presión completo con adaptador a bombona para controlar y reducir la presión

**PT** Redutor de pressão completo com engate para controlar e reduzir a pressão.

Example code: 39RHP

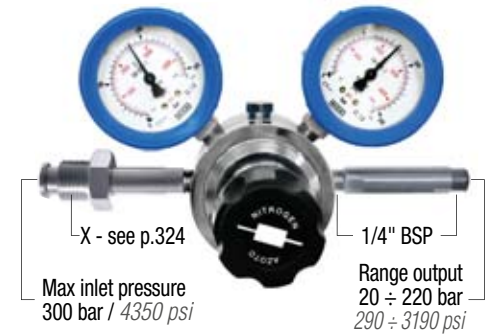

Installation Example

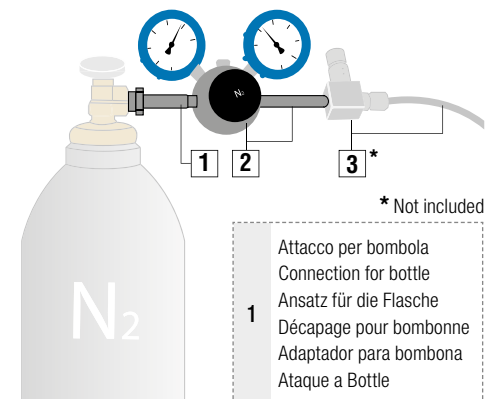

Riduttore di pressione max. 300 bar / 4350 psi  
Pressure reducer max. 300 bar / 4350 psi  
Druckminderer max. 300 bar / 4350 psi  
Réducteur de pression max. 300 bar / 4350 psi  
Reductor de presión max. 300 bar / 4350 psi  
Redutor de pressão max. 300 bar / 4350 psi

3\* Tubo collegamento bombola con valvola di scarico  
Connecting hose from the bottle to the valve discharging  
Flaschen-Verbindungsschlauch mit Auslassventil  
Tube pour la connexion bombonne avec valve de décharge  
Tubo de conexión a bombona con válvula de descarga  
Tubo de ligação Frasco com a válvula de descarga

# ACCESSORIES



\* Not included

code	Box content 1 + (2 + 3) + 4	Power supply	Country	Kg	
39NCU01B	Booster + 39RHP	220 ÷ 240 VAC 50 ÷ 60 Hz	Italy - Portugal	105 kg	231 lbs
39NCU10B	Booster + 39RHP01	220 ÷ 240 VAC 50 ÷ 60 Hz	China - Korea	105 kg	231 lbs
39NCU11B	Booster + 39RHP02	220 ÷ 240 VAC 50 ÷ 60 Hz	Indonesia	105 kg	231 lbs
39NCU12B	Booster + 39RHP03	220 ÷ 240 VAC 50 ÷ 60 Hz	Germany	105 kg	231 lbs
39NCU13B	Booster + 39RHP04	220 ÷ 240 VAC 50 ÷ 60 Hz	France	105 kg	231 lbs
39NCU14B	Booster + 39RHP05	220 ÷ 240 VAC 50 ÷ 60 Hz	India	105 kg	231 lbs
39NCU15B	Booster + 39RHP06	220 ÷ 240 VAC 50 ÷ 60 Hz	Russia	105 kg	231 lbs
39NCU22B	Booster + 39RHP07	120 VAC 50 ÷ 60 Hz	USA	116 kg	255 lbs
39NCU23B	Booster + 39RHP08	120 VAC 50 ÷ 60 Hz	USA	116 kg	255 lbs
39NCU29B	Booster + 39RHP09	220 ÷ 240 VAC 50 ÷ 60 Hz	Spain	105 kg	231 lbs
39NCU31B	Booster + 39RHP10	220 ÷ 240 VAC 50 ÷ 60 Hz	Korea	105 kg	231 lbs
39NCU32B	Booster + 39RHP11	220 ÷ 240 VAC 50 ÷ 60 Hz	Germany	105 kg	231 lbs
39NCU33B	Booster + 39RHP12	220 ÷ 240 VAC 50 ÷ 60 Hz	India	105 kg	231 lbs
39NCU34B	Booster + 39RHP13	100 VAC 50 ÷ 60 Hz	Japan	120 kg	265 lbs
39NCU40B	Booster + 39RHP14	220 ÷ 240 VAC 50 ÷ 60 Hz	Portugal	105 kg	231 lbs
39NCU41B	Booster + 39RHP02	100 VAC 50 ÷ 60 Hz	Japan	120 kg	265 lbs
39NCU42B	Booster + 39RHP15	220 ÷ 240 VAC 50 ÷ 60 Hz	United Kingdom	105 kg	231 lbs

1	<p>Booster carrellato per il caricamento di grandi volumi di azoto, con azionamento elettro-idraulico per la massima velocità Wheeled Booster for the filling of large volumes of nitrogen, with electro-hydraulic start-up for the maximum speed Ein fahrbarer Booster für die Ladung großer Mengen von Stickstoff, mit elektrohydraulischem Antrieb für Maximalgeschwindigkeit. Booster à chariot, pour la charge de grands volumes d'azote, avec actionnement électro-hydraulique pour la vitesse maximum Booster con ruedas para la carga de grandes volúmenes de nitrógeno con accionamiento electro-hidráulico para máxima rapidez. Booster rodado para o carregamento de grandes volumes de nitrogênio com acionamento eletro-hidráulico para a velocidade máxima</p>	2	<p>Attacco per bombola Connection for bottle Ansatz für die Flasche Décapage pour bombonne Adaptador para bombona Ataque a Bottle</p>	<p>Direct to N2 bottle p. 324</p>	
3	<p>Riduttore di pressione Pressure reducer Druckminderer Réducteur de pression Reductor de presión Redutor de pressão</p>	4	<p>Tubo collegamento bombola con valvola di scarico Connecting hose from the bottle to the valve discharging Verbindung Schlauche des Flasche mit Auslassventil Tube pour la connexion bombonne avec valve de décharge Tubo de conexión a bombona con válvula de descarga Tubo de ligação Frasco com a válvula de descarga</p>	5*	<p>Dispositivo di caricamento DMA Charging device DMA Ladung Vorrichtung DMA Dispositif de charge DMA Dispositivo de carga DMA Dispositivo de carregamento de DMA</p>

## IT Caratteristiche - vantaggi

- Massima sicurezza, minimi tempi di caricamento
  - Arresto automatico alla pressione impostata
  - Segnale luminoso di fine ciclo
  - Valvola di sicurezza per sovrappressione
  - Pompa elettrica
  - Pressione di uscita regolabile
  - Telaio carrellato con alloggiamento bombola N2
  - Utilizzare con set di caricamento DMA (opzionale)
- La fornitura comprende:** Unità booster, 3 mt di tubo per collegamento a bombola o riduttore di pressione + attacco per bombola.

## FR Caractéristiques - avantages

- Sécurité maximum, temps de chargement minimum
  - Arrêt automatique à la pression établie
  - Signal lumineux de fin de cycle
  - Valve de sécurité pour la surpression
  - Pompe électrique
  - Pression de sortie réglable
  - Châssis à chariot avec logement de bonbonne N2
  - À utiliser avec le set de chargement DMA (en option)
- La fourniture inclut:** Unité booster, 3 mt de tube pour la connexion à la bombonne ou au réducteur de pression + Décapage bombonne.

## EN Features - advantages

- Maximum safety, low charging time
  - Automatic stop when the set pressure is reached
  - Light indicator of cycle end
  - Safety valve for overpressure
  - Electric pump
  - Adjustable output pressure
  - Wheeled cart with N2 bottle housing
  - To be used with charging set DMA (optional)
- The supply includes:** Booster unit, 3 mt hose for connecting the bottle or pressure reducer + bottle connection.

## ES Características - Ventajas

- Máxima seguridad, tiempo mínimo de carga
  - Parada automática en la presión elegida
  - Señal luminosa de final de ciclo
  - Válvula de seguridad para sobrepresión
  - Bomba eléctrica
  - Presión de salida regulable
  - Chasis sobre ruedas y alojamiento para botella de N2
  - Utilizar combinado con set de carga DMA (opcional)
- El suministro incluye:** Unidad Booster, tubo de 3 mt para conexión a la bombona o al reductor de presión + adaptador para Bombona.

## DE Eigenheiten - Vorteile

- Maximale Sicherheit, minimale Befüllzeiten
  - Automatisches Anhalten beim Erreichen des Drucks
  - Leuchtsignal bei Zyklusende
  - Überdruck-Sicherheitsventil
  - Elektrische Pumpe
  - Einstellbarer Output-Druck
  - Fahrbares Gestell mit Ablagefach für N2-Gasflasche
  - Zum Einsatz mit der DMA Ladevorrichtung (optional)
- Die Lieferung beinhaltet:** Booster Gerät, 3 Meters Schlauch für den Anschluss zur Flasche oder zum Druckminderer + Ansatz für die Flasche.

## PT Características - Benefícios

- Máxima segurança, tempos de carregamento mais baixos
  - Paragem automática quando atingida a pressão especificada
  - Sinal luminoso de fim de ciclo
  - Válvula de segurança activa sobrepresão
  - Bomba eléctrica
  - Saída de pressão ajustável
  - Quadro rodado com alojamento para tank N2
  - Utilizado com o conjunto de carregamento DMA (opcional)
- O fornecimento inclui:** Unidade Booster, 3 mt tubo para ligação ao cilindro de azoto ou de reductor de pressão + Ataque a Bottle.

0,85 kW see power supply	210 bar 3045 psi	30 bar 435 psi	1300 NL / min *	0 - 45 °C 32 - 113 °F	600 x 560 x 680 mm 24 x 22 x 27 inch	See tab.

\* Il rendimento volumetrico varia in funzione di PN<sub>2</sub> - The volumetric efficiency varies according to PN<sub>2</sub> - Der Liefergrad ändert sich in Abhängigkeit vom PN<sub>2</sub>  
Le rendement volumétrique varie en fonction de PN<sub>2</sub> - El rendimiento volumétrico varía en función de PN<sub>2</sub> - O rendimento volumétrico varia em função da PN<sub>2</sub>

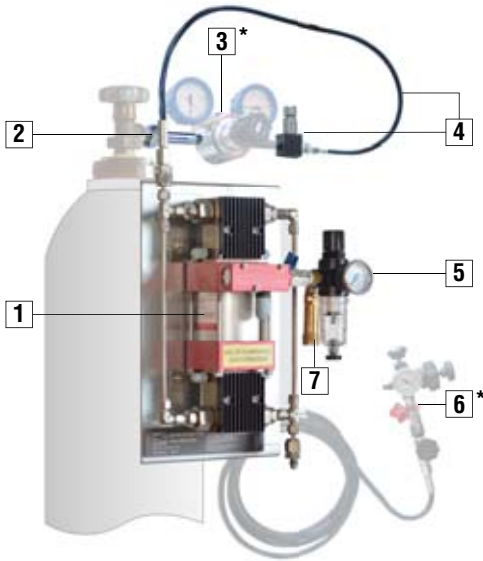

\* Not included

To N2 bottle with pressure reducer  
 p. 325

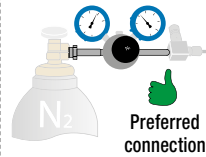

Direct to N2 bottle  
 p. 324



code	Box content 1 + 2	Country
39NCU03A	AirBooster + 47TB	Italy - Portugal
39NCU04A	AirBooster + 47TB01	China - Korea
39NCU05A	AirBooster + 47TB02	Japan - Indonesia
39NCU06A	AirBooster + 47TB03	Germany
39NCU07A	AirBooster + 47TB04	France
39NCU08A	AirBooster + 47TB05	India
39NCU09A	AirBooster + 47TB06	Russia
39NCU26A	AirBooster + 47TB07	USA
39NCU27A	AirBooster + 47TB08	USA
39NCU28A	AirBooster + 47TB09	Spain
39NCU35A	AirBooster + 47TB10	Korea
39NCU36A	AirBooster + 47TB11	Germany
39NCU37A	AirBooster + 47TB12	India
39NCU38A	AirBooster + 47TB13	Japan
39NCU39A	AirBooster + 47TB14	Portugal
39NCU43A	AirBooster + 47TB15	UK

1	Booster portatile compatto per caricamento azoto con azionamento pneumatico Compact portable booster for the filling of nitrogen, with pneumatic start-up Ein kompakter und portabler Booster Booster compacte et portable pour la charge avec azote, avec actionnement pneumatique Booster compacto y portátil para la carga con nitrógeno con accionamiento neumático Booster compacto e portátil para carregar com nitrogênio com acionamento pneumático	2	Attacco per bombola Connection for bottle Ansatz für die Flasche Décapage pour bombonne Adaptador para bombona Ataque a Bottle	3*	Riduttore di pressione Pressure reducer Druckminderer Réducteur de pression Reductor de presión Redutor de pressão
4	Tubo collegamento bombola con valvola di scarico Connecting hose from the bottle to the valve discharging Flaschen-Verbindungsschlauch mit Auslassventil Tube pour la connexion bombonne avec valve de décharge Tubo de conexión a bombona con válvula de descarga Tubo de ligação Frasco com a válvula de descarga	5	Ingresso aria Air inlet Luft Eingang Entrée de l'air Entrada de aire Entrada de ar	6*	Dispositivo di caricamento DMA Charging device DMA Lade-Vorrichtung DMA Dispositif de charge DMA Dispositivo de carga DMA Dispositivo de carregamento de DMA
				7	Valvola sicurezza e ingresso aria Safety valve and air inlet Sicherheitsventil und Lufteingang Valve de sécurité et entrée de l'air Válvula de seguridad y entrada de aire Válvula de segurança e entrada de ar

### IT Caratteristiche - Vantaggi

- Compatto, leggero e portabile
- Massimo utilizzo del volume bombola N2
- Installazione diretta su bombola N2
- Valvola di sicurezza output N2 max 220 bar

**La fornitura comprende:** Unità booster completa di valvola di sicurezza, supporto per bombola, 1 mt di tubo per collegamento a bombola o riduttore di pressione + attacco per bombola.

### EN Features - Advantages

- Compact, light and portable
- Max use of the nitrogen bottle N2
- Direct installation on the N2 bottle
- Safety N2 output valve max 220 bar

**The supply includes:** Booster unit provided with safety valve, bottle support, 1 mt hose for connecting the bottle or pressure reducer + bottle connection.

### DE Eigenschaften - Vorteile

- Kompakt, leicht und portabel
- Maximaler Nutzung der Stickstoffflasche N2
- Direkte Installation an Stickstoffflasche N2
- Sicherheitsventil output N2, max. 220 bar.

**Die Lieferung beinhaltet:** Booster-Gerät versehen mit Sicherheitsventil, Träger für die Stickstoffflasche, 1 Meter Schlauch für den Anschluss zur Flasche oder zum Druckminderer + Ansatz für die Flasche.

### FR Caractéristiques - Avantages

- Compacte, léger et portable
- Utilisation maximale de la bombonne d'azote N2
- Installation directe sur la bombonne d'azote N2
- Valve de sortie N2 sécurisé max 220 bar

**La fourniture inclut:** Unité booster équipé avec valve de sécurité, support pour bombonne, 1 mt de tube pour la connexion à la bombonne ou au réducteur de pression + Décapage bombonne.

### ES Características - Ventajas

- Compacto, ligero y portátil
- Uso máximo de la bombona de nitrógeno N2
- Instalación directamente sobre la bombona de N2
- Válvula de seguridad, output N2 max 220 bar

**El suministro incluye:** Unidad Booster equipado con válvula de seguridad, soporte para la bombona de nitrógeno, tubo de 1 mt para la conexión a la bombona o al reductor de presión + Adaptador a Bombona.

### PT Características - Benefícios

- Compacto, leve e portátil
- Máxima utilização do cilindro de nitrogênio N2
- Instalação directamente sobre o cilindro de N2
- Válvula de segurança, saída máxima de 220 bar N2

**O fornecimento inclui:** Unidade Booster equipado com válvula de segurança, o suporte para o cilindro de nitrogênio, 1 mt tubo para ligação ao cilindro de azoto ou de reductor de pressão + Ataque a Bottle.

<b>AIR</b> 1 - 10 bar 15 - 145 psi	220 bar 3190 psi	30 bar 435 psi	280 NL / min *	0 - 45 °C 32 - 113 °F	230 x 350 x 230 mm 9 x 13 x 9 inch	10,8 Kg 23.8 lbs

\* Il rendimento volumetrico varia in funzione di Pair e PN<sub>2</sub> - The volumetric efficiency varies according to Pair and PN<sub>2</sub> - Der Volumen-Liefergrad ändert sich in Abhängigkeit vom Pair und PN<sub>2</sub>  
 Le rendement volumétrique varie en fonction de Pair et PN<sub>2</sub> - El rendimiento volumétrico varia en función de PN<sub>2</sub> - O rendimento volumétrico varia em função da Pair e PN<sub>2</sub>

# ACCESSORIES



**IT** Trolley completo di AirBooster e dispositivo 39DMA.

**DE** Trolley mit AirBooster und Füll- und Kontrollarmatur 39DMA.

**ES** Maleta completa con AirBooster y dispositivo 39DMA.

**EN** Trolley with AirBooster and charging device 39DMA.

**FR** Chariot avec AirBooster et kit de chargement 39DMA.

**PT** Maleta completa com Booster e Kit de carregamento 39DMA.



**AirBooster**



p. 327



**39DMA**



p. 318

code	Box content	Country
39KNCU03A	39NCU03A + 39DMA	Italy - Portugal
39KNCU04A	39NCU04A + 39DMA	China - Korea
39KNCU05A	39NCU05A + 39DMA	Japan - Indonesia
39KNCU06A	39NCU06A + 39DMA	Germany
39KNCU07A	39NCU07A + 39DMA	France
39KNCU08A	39NCU08A + 39DMA	India
39KNCU09A	39NCU09A + 39DMA	Russia
39KNCU26A	39NCU26A + 39DMA	USA
39KNCU27A	39NCU27A + 39DMA	USA
39KNCU28A	39NCU28A + 39DMA	Spain
39KNCU35A	39NCU35A + 39DMA	Korea
39KNCU36A	39NCU36A + 39DMA	Germany
39KNCU37A	39NCU37A + 39DMA	India
39KNCU38A	39NCU38A + 39DMA	Japan
39KNCU39A	39NCU39A + 39DMA	Portugal
39KNCU40A	39NCU43A + 39DMA	UK

## **IT** Caratteristiche

Trolley con struttura antiurto e valvola pressurizzata per lo spostamento aereo e la sicurezza dei dispositivi all'interno.

## **EN** Features

Trolley with shock-resistant structure and pressure relief valve for transport in the aircraft and safe storage of the contents.

## **DE** Eigenheiten

Trolley mit stoßfester Struktur und Überdruckventil für den Transport im Flugzeug und ein sicheres Verstauen des Inhalts.

## **FR** Caractéristiques

Chariot avec structure résistante aux chocs et soupape de surpression pour le transport dans l'avion et le stockage sécurisé du contenu.

## **ES** Características

Maleta con estructura a prueba de golpes y válvula presurizada para viajes aéreos y para la seguridad de los dispositivos en el interior.

## **PT** Características

Maleta de ferramentas com estrutura reforçada e pressurizada para viagens aéreas garantindo a segurança dos equipamentos.

**IT** Stazione mobile per caricamento, controllo forza e manutenzione dei cilindri ad azoto.

**EN** Mobile service station for charging, force testing and maintenance of gas springs.

**DE** Mobile Servicestation zum Befüllen, zur Druckkontrolle und zur Wartung der Gasdruckfedern.

**FR** Station de service mobile pour le chargement, la mesure de force et la maintenance de ressorts à gaz.

**ES** Estación móvil para carga, control de fuerza y mantenimiento de cilindros de gas.

**PT** Estação de trabalho movel para carregamento, ajuste de força e manutenção dos cilindros.

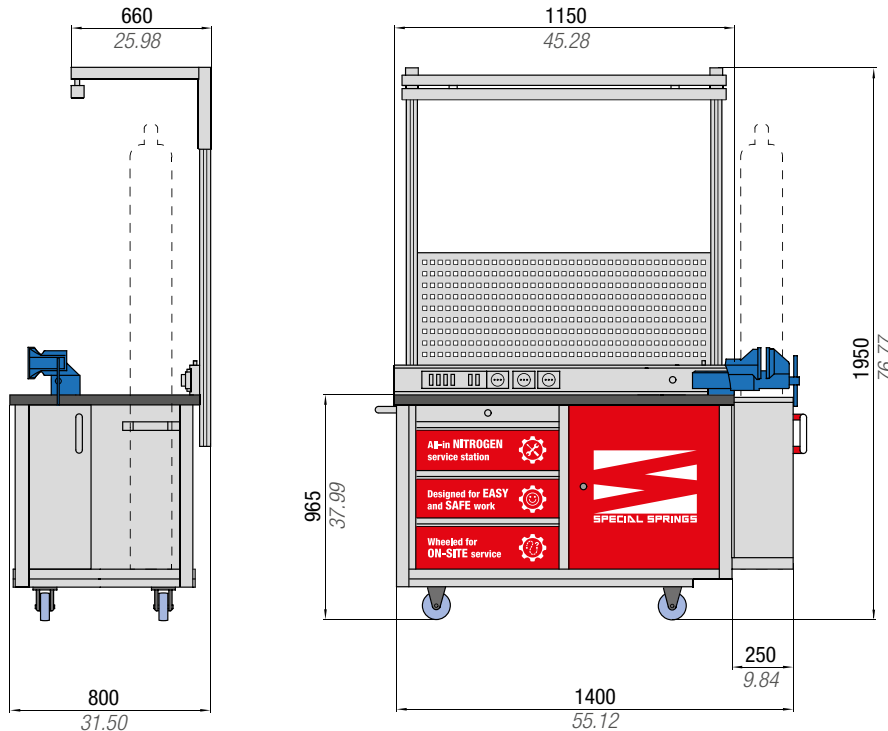

code	Country
58UT027A	Italy - Denmark Egypt - Russia Austria - Indonesia India - Greece Holland - Romania Finlandia Czech Republic Spain - France Slovenia - Portugal Turkey - Korea Germany
58UT031A	Japan - Usa
58UT032A	Belgium - France
58UT033A	United Kingdom
58UT034A	Brasil
58UT036A	China

## IT Vantaggi

- Unica postazione per strumenti e kit.
- Elevata mobilità.
- Maggiore sicurezza e comodità per ogni operazione.
- Predisposizione ancoraggio force tester.

## FR Avantages

- Station tout-en-un pour tous outils et appareils.
- Grande mobilité.
- Plus de sécurité et de confort pour chaque opération.
- Préparé pour le montage du testeur de force.

## IT Dati tecnici

- 3 cassetti (1 con vaschetta raccogli olio) + anta per riporre kit e tools.
- Piano di lavoro 1400 x 685 x 40 mm.
- Lampada a led con interruttore.
- Attacco aria compressa da 1/4".
- 3 prese elettriche.
- Connettore di alimentazione non incluso.
- Morsa parallela 130 mm.
- Protezione operatore da proiezione parti in fase di caricamento.

## FR Données techniques

- 3 tiroirs (un avec bac de récupération d'huile) + compartiment fermé avec porte pour ranger kits et outils.
- Plan de travail 1400 x 685 x 40 mm.
- Lumière LED avec interrupteur.
- Alimentation en air comprimé 1/4".
- 3 prises de courant.
- La prise électrique n'est pas comprise.
- Étau parallèle 130 mm.
- Protection de l'opérateur contre la projection de pièces lors du chargement.

## EN Advantages

- All-in-one station for all tools and devices.
- High mobility.
- More safety and comfort for each operation.
- Prepared for mounting of force tester.

## ES Ventajas

- Estación todo en uno para herramientas y kits.
- Alta movilidad.
- Mayor seguridad y comodidad para cada operación.
- Preparada para el montaje de tester de fuerza.

## EN Technical Data

- 3 drawers (one with oil drain pan) + compartment closed with door for storing kits and tools.
- Worktop 1400 x 685 x 40 mm.
- LED light with switch.
- Compressed air supply 1/4".
- 3 power sockets.
- The electrical plug is not included.
- Parallel vice 130 mm.
- Operator's protection against projection of parts during charging.

## ES Datos técnicos

- 3 cajones (1 con bandeja de recogida de aceite) + puerta para guardar kit y herramientas.
- Encimera 1400 x 685 x 40 mm.
- Lámpara LED con interruptor.
- Conexión de aire comprimido de 1/4".
- 3 enchufes eléctricos.
- El enchufe eléctrico no está incluido.
- Tornillo de banco 130 mm.
- Protección del operador contra la proyección de piezas durante la carga.

## DE Vorteile

- All-in-one Servicestation für Werkzeuge und Reparatursätze.
- Hohe Mobilität.
- Mehr Sicherheit und Komfort bei jedem Arbeitsschritt.
- Aufnahme zur Befestigung des Kraftmessgeräts.

## PT Benefícios

- Todas as ferramentas e kit de carregamento em um so lugar.
- Total mobilidade.
- Maior segurança e comodidade.
- Já preparada para o Dinamometro.

## DE Technische Daten

- 3 Schubladen (davon eine mit Ölauffangwanne) + mit Tür verschlossenes Fach zur Aufbewahrung von Reparatursätzen und Werkzeugen.
- Arbeitsplatte 1400 x 685 x 40 mm.
- LED-Leuchte mit Schalter.
- 1/4" Druckluftanschluss.
- 3 Steckdosen.
- Der Stromstecker ist nicht enthalten.
- Parallelschraubstock 130 mm.
- Schutz des Bedieners gegen das Herausspringen von Teilen beim Befüllen.

## PT Dados técnicos

- 3 Gavetas (1 com espaços demarcados para os kits de manutenção) as outras para armazenar instrumentos e ferramentas.
- Mesa de trabalho de 1400 x 685 x 40mm.
- Lampada de LED com interruptor.
- Saída para ar comprimido 1/4".
- 3 tomadas.
- A ficha eléctrica não está incluída.
- Morsa paralela de 130mm.
- Proteção para o operador enquanto carrega os cilindros.

# ACCESSORIES - DIGITAL FORCE TESTER



code 39FT02000



code 39FT00250B

code 39FT00500B

	<b>Measuring range</b>	0 ÷ 2000 daN <i>0 ÷ 4496 lb</i>	0 ÷ 250 daN <i>0 ÷ 562 lb</i>	0 ÷ 500 daN <i>0 ÷ 1124 lb</i>
	<b>Recommended for FO</b>	0 ÷ 1500 daN <i>0 ÷ 3372 lb</i>	0 ÷ 250 daN <i>0 ÷ 562 lb</i>	250 ÷ 500 daN <i>562 ÷ 1124 lb</i>
	<b>Max. length</b>	430 mm <i>16.93 inch</i>	430 mm <i>16.93 inch</i>	430 mm <i>16.93 inch</i>
	<b>Max. diameter</b>	75 mm <i>2.95 inch</i>	45 mm <i>1.77 inch</i>	45 mm <i>1.77 inch</i>
	<b>Accuracy according EN ISO 7500-1</b>	-	<b>CLASS 1</b> (± 1%)	<b>CLASS 1</b> (± 1%)
	<b>Power supply</b>	Battery (included)	100 - 240 VAC 50-60 Hz	100 - 240 VAC 50-60 Hz
	<b>L x P x H</b>	255 x 310 x 1300 mm <i>10.04 x 12.20 x 51.18 inch</i>	385 x 250 x 947 mm <i>15.16 x 9.84 x 37.28 inch</i>	385 x 250 x 947 mm <i>15.16 x 9.84 x 37.28 inch</i>
	<b>Weight</b>	22 Kg <i>48.50 lb</i>	82 Kg <i>180.78 lb</i>	82 Kg <i>180.78 lb</i>

code 59VCATM02

1



DIGITAL DISPLAY

code 59RE150

2









DIGITAL LINEAR SCALE



**code 39FT07500B** 

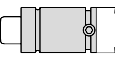

**code 39FT20000** 

	<b>Measuring range</b>	<b>0 ÷ 7500 daN</b> <i>0 ÷ 16861 lb</i>	<b>0 ÷ 20000 daN</b> <i>0 ÷ 44962 lb</i>
	<b>Recommended for FO</b>	<b>500 ÷ 7500 daN</b> <i>1124 ÷ 16861 lb</i>	<b>7500 ÷ 20000 daN</b> <i>16861 ÷ 44962 lb</i>
	<b>Max. length</b>	<b>400 mm</b> <i>15.75 inch</i>	<b>760 mm</b> <i>29.92 inch</i>
	<b>Max. diameter</b>	<b>120 mm</b> <i>4.72 inch</i>	<b>195 mm</b> <i>7.68 inch</i>
	<b>Accuracy according EN ISO 7500-1</b>	<b>CLASS 1</b> <b>(± 1%)</b>	<b>CLASS 1</b> <b>(± 1%)</b>
	<b>Power supply</b>	<b>100 - 240 VAC 50-60 Hz</b>	<b>100 - 240 VAC 50-60 Hz</b>
	<b>L x P x H</b>	<b>385 x 260 x 1350 mm</b> <i>15.16 x 10.24 x 53.15 inch</i>	<b>576 x 250 x 1314 mm</b> <i>22.68 x 9.84 x 51.73 inch</i>
	<b>Weight</b>	<b>82 Kg</b> <i>180.78 lb</i>	<b>194 Kg</b> <i>427.77 lb</i>

**code 59VCATM02**



**1**

DIGITAL DISPLAY

**code 59RE150**



**2**

DIGITAL LINEAR SCALE